



## Overview

- DIN Rail, Snaptrack or Surface Mount
- Compact & Cost-Effective 350 mA Unit
- Self-resetting Thermal Fuse
- Operation & Fault LED Indicators
- Fixed or Adjustable Outputs
- Output Protected Against Overload and Shorting

BAPI's 350A-EZ is a cost-effective way of converting 24 VAC or VDC to 5, 12, 15 or 24 VDC for use on peripheral devices that require DC voltage. The converter is available with a 350 mA output. The revolutionary mounting system allows for 2.75" snaptrack, DIN rail or surface mounting.

Although most BAPI room units can run on 24 VAC power, converting to DC power eliminates the AC power "noise" which can affect the room sensor readings. BAPI's tests show that fluctuating and inaccurate signal levels are possible when AC power wiring is present in the same cable as the signal lines. All fixed outputs of 5, 10, 12 or 15 VDC are adjustable  $\pm 10\%$ . The adjustable model has an output of 5 to 24 VDC.



**VC350A EZ mounted on DIN Rail**

## Ordering Information

Part Number	Description	List Price
BA/VC350A-EZ-5	5 VDC Output at 350 mA	\$53
BA/VC350A-EZ-10	10 VDC Output at 350 mA	\$53
BA/VC350A-EZ-12	12 VDC Output at 350 mA	\$53
BA/VC350A-EZ-15	15 VDC Output at 350 mA	\$53
BA/VC350A-EZ-ADJ	5 to 24 VDC Adjustable Output at 350 mA	\$53

Submittal datasheets without List Prices are available on our website at [www.bapihvac.com](http://www.bapihvac.com)

## Specifications

**Output Voltage:** 5 to 24 VDC @ 350 mA

**Recommended Input Voltage:** 18 to 28 VAC, 24 VDC (15 VA)

**Input Voltage Limits:**

Model of Unit	Minimum (VAC/VDC)	Maximum (VAC/VDC)	Input Current@ Min Input Volts (AC/DC)
5V	5.0/9.0	28.0/35.0	5.2 VA/305 mA
10V	10.0/14.7	28.0/35.0	8.3 VA/315 mA
12V	12.0/16.9	28.0/35.0	9.5 VA/318 mA
15V	15.0/20.5	28.0/35.0	11.2 VA/320 mA
ADJ (24V)	24.0/31.0*	28.0/35.0*	16.7 VA/325 mA*

\*These specs are for 24V output. Lower voltage output specs are similar to the fixed model specs above.

**Environmental Operation Range:**

0 to 95% RH non-condensing
-40 to 149°F (-40 to 65°C) 350 mA @ any output voltage
-40 to 158°F (-40 to 70°C) 350 mA @ 5 VDC
330 mA @ 10 VDC
280 mA @ 12 VDC
224 mA @ 15 VDC
140 mA @ 24 VDC

**Environmental Storage Range:**  
-40 to 176°F (-40 to 80°C)

**Wiring:** 4 wires, 16 to 22 gauge

**Rectification:** Half-Wave Rectified

**Grounding:**  
AC & DC Ground are Common

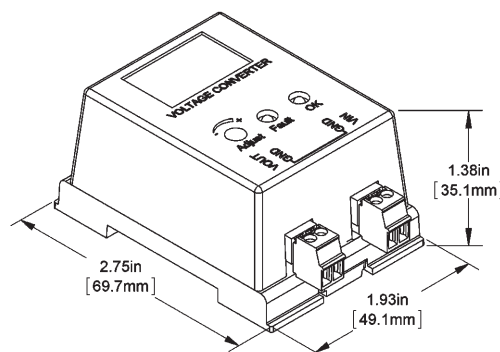

Note: The VC350A-EZ is a Class 2 circuit when it is powered from a UL Class 2 power supply.

