



WIDE BAND SPDT SWITCH

DESCRIPTION

The μPD5713TK is a CMOS MMIC for wide band SPDT (Single Pole Double Throw) switch which were developed for mobile communications, wireless communications and other general-purpose RF switching application.

This device can operate frequency from 0.05 to 2.5 GHz, having the low insertion loss and high isolation.

This device is housed in a 6-pin lead-less minimold (1511) package. And this package is able to high-density surface mounting.

FEATURES

- Supply voltage : $V_{DD} = 1.8$ to 3.6 V (2.8 V TYP.)
- Switch control voltage : $V_{cont(H)} = 1.8$ to 3.6 V (2.8 V TYP.)
 : $V_{cont(L)} = -0.2$ to $+0.4$ V (0 V TYP.)
- Low insertion loss : $L_{ins1} = 0.6$ dB TYP. @ $f = 0.05$ to 1.0 GHz, $V_{DD} = 2.8$ V, $V_{cont(H)} = 2.8$ V, $V_{cont(L)} = 0$ V
 : $L_{ins2} = 0.8$ dB TYP. @ $f = 1.0$ to 2.0 GHz, $V_{DD} = 2.8$ V, $V_{cont(H)} = 2.8$ V, $V_{cont(L)} = 0$ V
 : $L_{ins3} = 0.95$ dB TYP. @ $f = 2.0$ to 2.5 GHz, $V_{DD} = 2.8$ V, $V_{cont(H)} = 2.8$ V, $V_{cont(L)} = 0$ V
- High isolation : $ISL1 = 32.5$ dB TYP. @ $f = 0.05$ to 1.0 GHz, $V_{DD} = 2.8$ V, $V_{cont(H)} = 2.8$ V, $V_{cont(L)} = 0$ V
 : $ISL2 = 25$ dB TYP. @ $f = 1.0$ to 2.0 GHz, $V_{DD} = 2.8$ V, $V_{cont(H)} = 2.8$ V, $V_{cont(L)} = 0$ V
 : $ISL3 = 22.5$ dB TYP. @ $f = 2.0$ to 2.5 GHz, $V_{DD} = 2.8$ V, $V_{cont(H)} = 2.8$ V, $V_{cont(L)} = 0$ V
- Handling power : $P_{in(1dB)} = +21.0$ dBm TYP. @ $f = 1.0$ GHz, $V_{DD} = 2.8$ V, $V_{cont(H)} = 2.8$ V, $V_{cont(L)} = 0$ V
 : $P_{in(0.1dB)} = +17.0$ dBm TYP. @ $f = 1.0$ GHz, $V_{DD} = 2.8$ V, $V_{cont(H)} = 2.8$ V, $V_{cont(L)} = 0$ V
- High-density surface mounting : 6-pin lead-less minimold package (1.5 × 1.1 × 0.55 mm)

APPLICATIONS

- Mobile communications
- Wireless communications
- Another general-purpose RF switching applications

ORDERING INFORMATION

Part Number	Order Number	Package	Marking	Supplying Form
μPD5713TK-E2	μPD5713TK-E2-A	6-pin lead-less minimold (1511) (Pb-Free)	C3Q	<ul style="list-style-type: none"> • Embossed tape 8 mm wide • Pin 1, 6 face the perforation side of the tape • Qty 5 kpcs/reel

Remark To order evaluation samples, contact your nearby sales office.
 Part number for sample order: μPD5713TK-A

Caution Observe precautions when handling because these devices are sensitive to electrostatic discharge.

The information in this document is subject to change without notice. Before using this document, please confirm that this is the latest version.

PIN CONNECTIONS AND INTERNAL BLOCK DIAGRAM

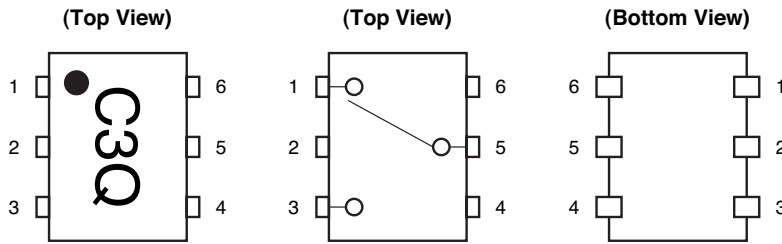

Pin No.	Pin Name
1	OUTPUT1
2	GND
3	OUTPUT2
4	V _{cont}
5	INPUT
6	V _{DD}

TRUTH TABLE

V _{cont}	INPUT-OUTPUT1	INPUT-OUTPUT2
Low	OFF	ON
High	ON	OFF

ABSOLUTE MAXIMUM RATINGS (T_A = +25°C, unless otherwise specified)

Parameter	Symbol	Ratings	Unit
Supply Voltage	V _{DD}	-0.5 to +4.6	V
Switch Control Voltage	V _{cont}	-0.5 to +4.6	V
Voltage Difference	V _{cont (H)} - V _{DD}	+0.5	V
Input Power	P _{in}	+23	dBm
Operating Ambient Temperature	T _A	-45 to +85	°C
Storage Temperature	T _{stg}	-55 to +150	°C

RECOMMENDED OPERATING RANGE (T_A = +25°C, unless otherwise specified)

Parameter	Symbol	MIN.	TYP.	MAX.	Unit
Supply Voltage	V _{DD}	+1.8	+2.8	+3.6	V
Switch Control Voltage (H)	V _{cont (H)}	+1.8	+2.8	+3.6	V
Switch Control Voltage (L)	V _{cont (L)}	-0.2	0	+0.4	V

Remark V_{DD} - 0.4 V ≤ V_{cont (H)} ≤ V_{DD} + 0.2 V

ELECTRICAL CHARACTERISTICS

($T_A = +25^\circ\text{C}$, $V_{DD} = 2.8\text{ V}$, $V_{\text{cont(H)}} = 2.8\text{ V}$, $V_{\text{cont(L)}} = 0\text{ V}$, DC cut capacitors = 1 000 pF, unless otherwise specified)

Parameter	Symbol	Test Conditions	MIN.	TYP.	MAX.	Unit
Insertion Loss 1	L_{ins1}	$f = 0.05$ to 1.0 GHz	–	0.6	0.8	dB
Insertion Loss 2	L_{ins2}	$f = 1.0$ to 2.0 GHz	–	0.8	1.0	dB
Insertion Loss 3	L_{ins3}	$f = 2.0$ to 2.5 GHz	–	0.95	1.2	dB
Isolation 1	ISL1	$f = 0.05$ to 1.0 GHz	30	32.5	–	dB
Isolation 2	ISL2	$f = 1.0$ to 2.0 GHz	22	25	–	dB
Isolation 3	ISL3	$f = 2.0$ to 2.5 GHz	20	22.5	–	dB
Input Return Loss	RL_{in}	$f = 0.05$ to 2.5 GHz	13	17	–	dB
Output Return Loss	RL_{out}	$f = 0.05$ to 2.5 GHz	13	17	–	dB
0.1 dB Loss Compression Input Power ^{Note 1}	$P_{\text{in (0.1 dB)}}$	$f = 1.0$ GHz	+13.0	+17.0	–	dBm
1 dB Loss Compression Input Power ^{Note 2}	$P_{\text{in (1 dB)}}$	$f = 1.0$ GHz	–	+21.0	–	dBm
Supply Current	I_{DD}	$V_{DD} = V_{\text{cont}} = 2.8\text{ V}$, RF off	–	0.01	1.0	μA
Switch Control Current	I_{cont}	$V_{DD} = V_{\text{cont}} = 2.8\text{ V}$, RF off	–	0.01	1.0	μA
Switch Control Speed	t_{sw}	$f = 1.0$ GHz	–	30	100	ns

Notes 1. $P_{\text{in (0.1 dB)}}$ is measured the input power level when the insertion loss increases more 0.1 dB than that of linear range.

- 2.** $P_{\text{in (1 dB)}}$ is measured the input power level when the insertion loss increases more 1 dB than that of linear range.

Caution It is necessary to use DC cut capacitors with this device.

The value of DC cut capacitors should be chosen to accommodate the frequency of operation, bandwidth, switching speed and the condition with actual board of your system.

EVALUATION CIRCUIT

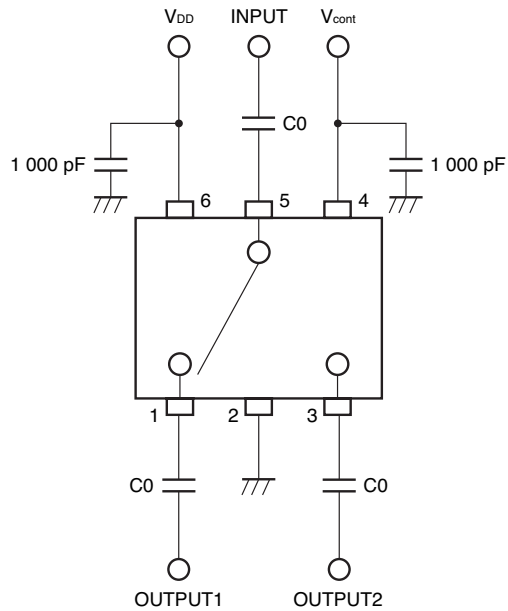

Remark C0 = 1 000 pF

Caution This IC has pull down resistance between RF line and GND, which fixes electric potential of RF line to 0 V, then the IC cannot be used for DC switching.

The application circuits and their parameters are for reference only and are not intended for use in actual design-ins.

ILLUSTRATION OF THE TEST CIRCUIT ASSEMBLED ON EVALUATION BOARD

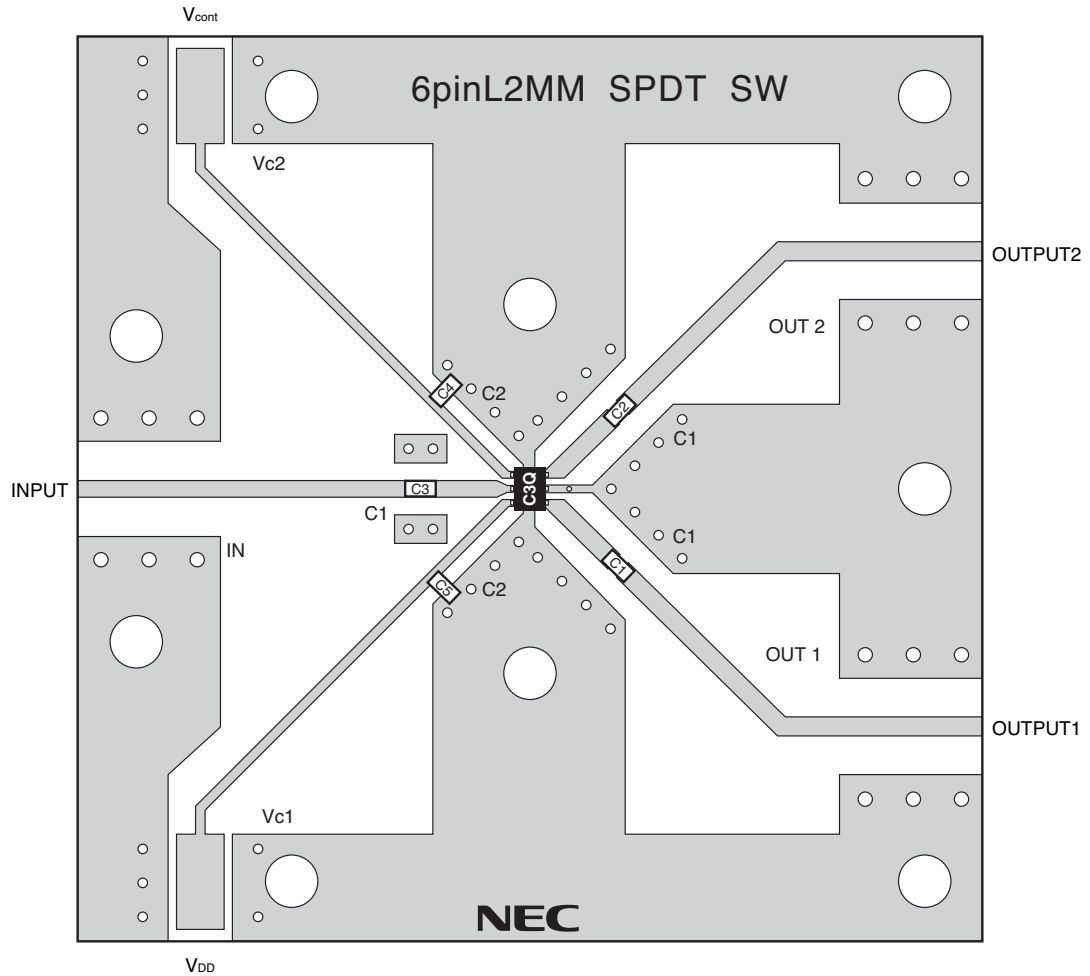

USING THE NEC EVALUATION BOARD

Symbol	Values
C1, C2, C3	1 000 pF
C4, C5	1 000 pF

TYPICAL CHARACTERISTICS

($T_A = +25^\circ\text{C}$, $V_{DD} = 2.8\text{ V}$, $V_{\text{cont (H)}} = 2.8\text{ V}$, $V_{\text{cont (L)}} = 0\text{ V}$, $P_{\text{in}} = 0\text{ dBm}$, DC cut capacitors = 1 000 pF, unless otherwise specified)

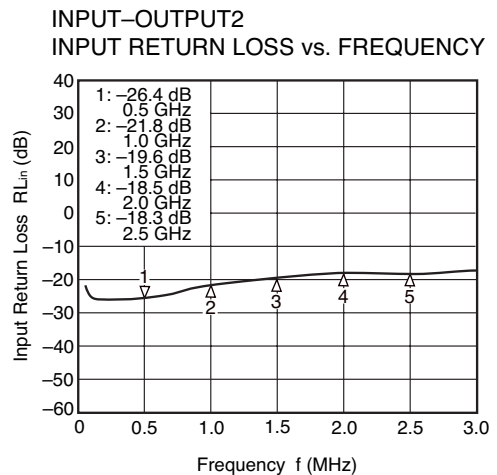
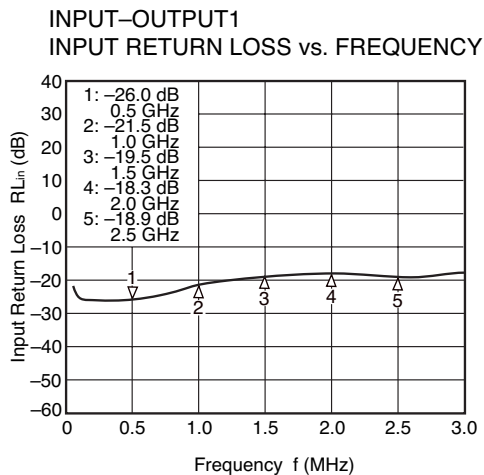
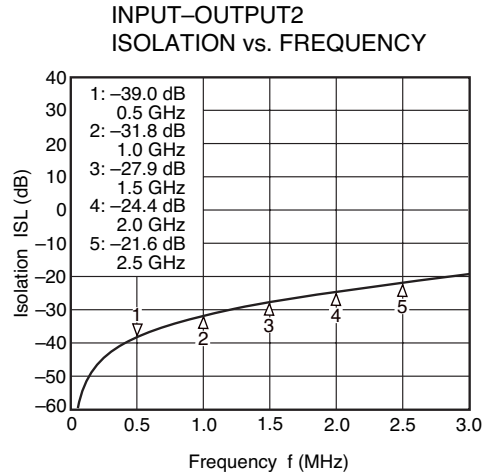
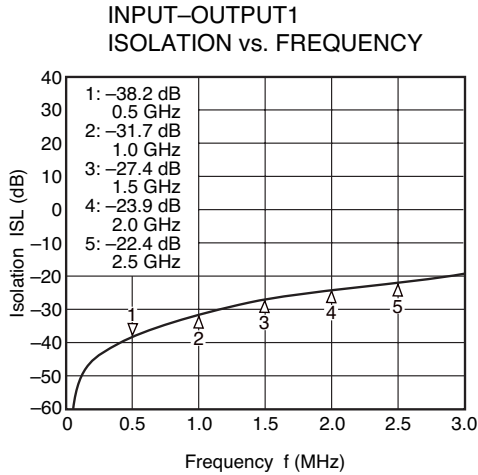
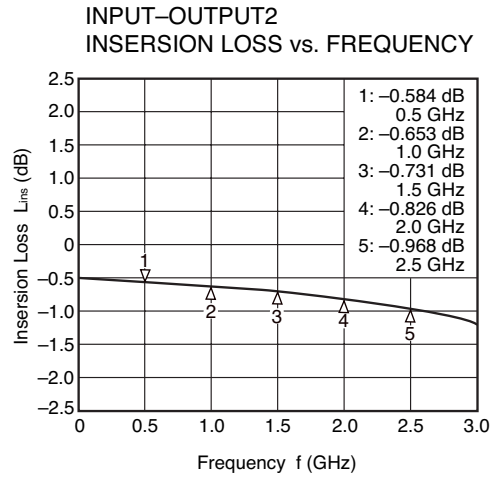
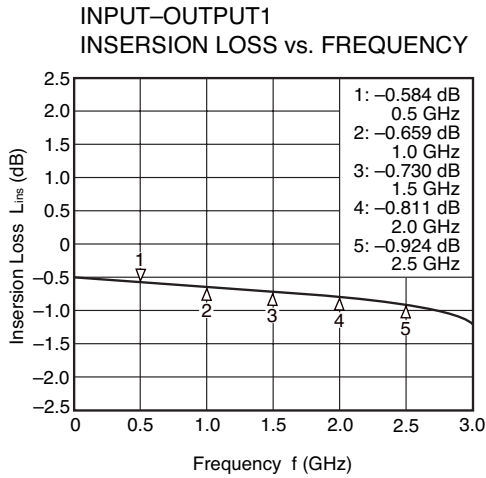

Remark The graphs indicate nominal characteristics.

INPUT-OUTPUT1
OUTPUT RETURN LOSS vs. FREQUENCY

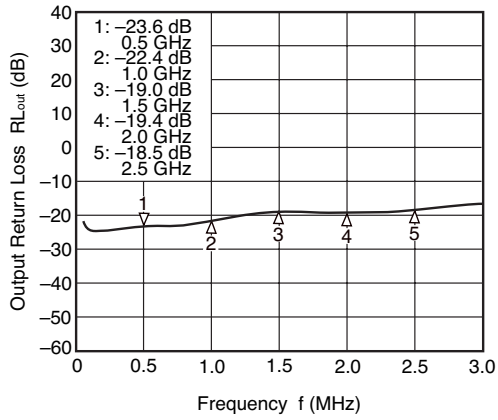

INPUT-OUTPUT2
OUTPUT RETURN LOSS vs. FREQUENCY

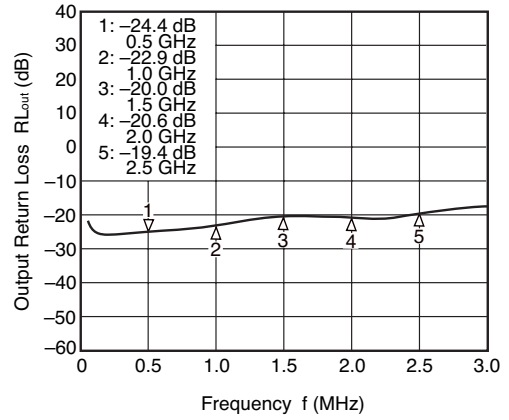

OUTPUT POWER vs. INPUT POWER

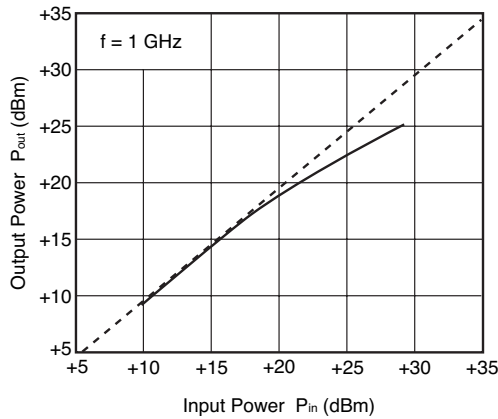

Remark The graphs indicate nominal characteristics.

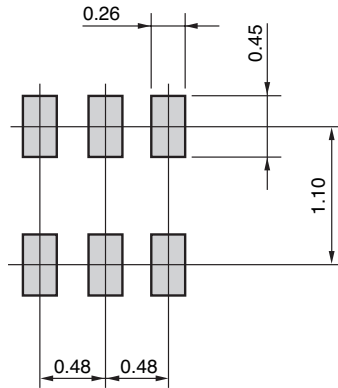
MOUNTING PAD DIMENSIONS**6-PIN LEAD-LESS MINIMOLD (1511) (UNIT: mm)**

Remark The mounting pad layouts in this document are for reference only.

PACKAGE DIMENSIONS

6-PIN LEAD-LESS MINIMOLD (1511) (UNIT: mm)

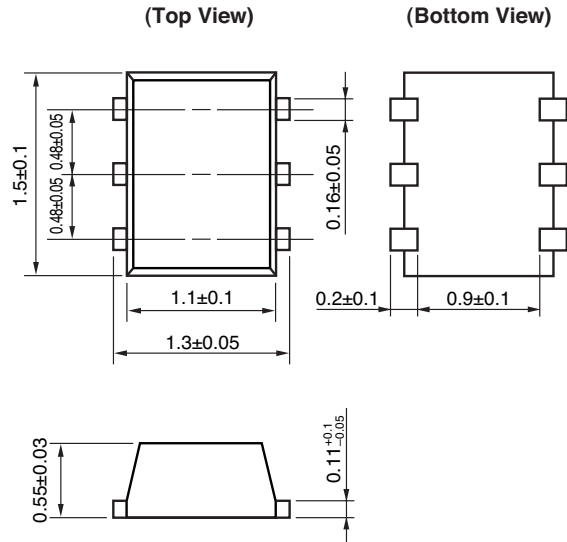

RECOMMENDED SOLDERING CONDITIONS

This product should be soldered and mounted under the following recommended conditions. For soldering methods and conditions other than those recommended below, contact your nearby sales office.

Soldering Method	Soldering Conditions	Condition Symbol
Infrared Reflow	Peak temperature (package surface temperature) : 260°C or below Time at peak temperature : 10 seconds or less Time at temperature of 220°C or higher : 60 seconds or less Preheating time at 120 to 180°C : 120±30 seconds Maximum number of reflow processes : 3 times Maximum chlorine content of rosin flux (% mass) : 0.2%(Wt.) or below	IR260
Wave Soldering	Peak temperature (molten solder temperature) : 260°C or below Time at peak temperature : 10 seconds or less Preheating temperature (package surface temperature) : 120°C or below Maximum number of flow processes : 1 time Maximum chlorine content of rosin flux (% mass) : 0.2%(Wt.) or below	WS260
Partial Heating	Peak temperature (terminal temperature) : 350°C or below Soldering time (per side of device) : 3 seconds or less Maximum chlorine content of rosin flux (% mass) : 0.2%(Wt.) or below	HS350

Caution Do not use different soldering methods together (except for partial heating).

Subject: Compliance with EU Directives

CEL certifies, to its knowledge, that semiconductor and laser products detailed below are compliant with the requirements of European Union (EU) Directive 2002/95/EC Restriction on Use of Hazardous Substances in electrical and electronic equipment (RoHS) and the requirements of EU Directive 2003/11/EC Restriction on Penta and Octa BDE.

CEL Pb-free products have the same base part number with a suffix added. The suffix –A indicates that the device is Pb-free. The –AZ suffix is used to designate devices containing Pb which are exempted from the requirement of RoHS directive (*). In all cases the devices have Pb-free terminals. All devices with these suffixes meet the requirements of the RoHS directive.

This status is based on CEL’s understanding of the EU Directives and knowledge of the materials that go into its products as of the date of disclosure of this information.

Restricted Substance per RoHS	Concentration Limit per RoHS (values are not yet fixed)	Concentration contained in CEL devices	
		-A	-AZ
Lead (Pb)	< 1000 PPM	Not Detected	(*)
Mercury	< 1000 PPM	Not Detected	
Cadmium	< 100 PPM	Not Detected	
Hexavalent Chromium	< 1000 PPM	Not Detected	
PBB	< 1000 PPM	Not Detected	
PBDE	< 1000 PPM	Not Detected	

If you should have any additional questions regarding our devices and compliance to environmental standards, please do not hesitate to contact your local representative.

Important Information and Disclaimer: Information provided by CEL on its website or in other communications concerning the substance content of its products represents knowledge and belief as of the date that it is provided. CEL bases its knowledge and belief on information provided by third parties and makes no representation or warranty as to the accuracy of such information. Efforts are underway to better integrate information from third parties. CEL has taken and continues to take reasonable steps to provide representative and accurate information but may not have conducted destructive testing or chemical analysis on incoming materials and chemicals. CEL and CEL suppliers consider certain information to be proprietary, and thus CAS numbers and other limited information may not be available for release.

In no event shall CEL’s liability arising out of such information exceed the total purchase price of the CEL part(s) at issue sold by CEL to customer on an annual basis.

See CEL Terms and Conditions for additional clarification of warranties and liability.