

NuTiny-SDK-NUC220 User Manual

for NuMicro™ NUC220 Series

The information described in this document is the exclusive intellectual property of Nuvoton Technology Corporation and shall not be reproduced without permission from Nuvoton.

Nuvoton is providing this document only for reference purposes of NuMicro™ microcontroller based system design. Nuvoton assumes no responsibility for errors or omissions.

All data and specifications are subject to change without notice.

For additional information or questions, please contact: Nuvoton Technology Corporation.

Table of Contents

1	Overview.....	3
2	Introduction to NuTiny-SDK-NUC220	4
2.1	NuTiny-SDK-NUC220 Jumper Description.....	5
2.2	Pin Assignment for Extended Connectors	6
2.3	NuTiny-SDK-NUC220 PCB Placement.....	7
3	Starting to Use NuTiny -SDK-NUC220 on the Keil μ Vision [®] IDE	8
3.1	Downloading and Installing Keil μ Vision [®] IDE Software	8
3.2	Downloading and Installing Nuvoton Nu-Link Driver	8
3.3	Hardware Setup.....	8
3.4	Smpl_NuTiny-NUC220 Program	9
4	Starting to Use NuTiny-SDK-NUC220 on the IAR Embedded Workbench ..	10
4.1	Downloading and Installing IAR Embedded Workbench Software.....	10
4.2	Downloading and Installing Nuvoton Nu-Link Driver	10
4.3	Hardware Setup.....	10
4.4	Smpl_NuTiny-NUC220 Program	11
5	NuTiny-EVB-NUC220 Schematics	12
6	Downloading NuMicro [™] Related Files from Nuvoton Website	13
6.1	Downloading NuMicro [™] Keil μ Vision [®] IDE Driver	13
6.2	Downloading NuMicro [™] IAR EWARM Driver	15
6.3	Downloading NuMicro [™] NUC220 series BSP Software Library	17
7	Revision History	18

1 Overview

The NuTiny-SDK-NUC220 is a specific development tool for the NuMicro NUC220 series users to develop and verify the application program easily. The NuTiny-SDK-NUC220 includes two portions: NuTiny-EVB-NUC220 (an evaluation board) and Nu-Link-Me (its Debug Adaptor), such that users do not need additional ICE or debug equipment.

2 Introduction to NuTiny-SDK-NUC220

The NuTiny-SDK-NUC220 uses the NUC220VE3AN as the target microcontroller. Figure 2-1 shows the NuTiny-SDK-NUC220 for NUC220 series, in which the left portion is called NuTiny-EVB-NUC220 and the right portion is called Nu-Link-Me. ...

The NuTiny-EVB-NUC220 is similar to other development boards, by which users can develop and verify applications to emulate the real behavior. The on board chip covers NUC220 series features. The NuTiny-EVB-NUC220 can be a real system controller to design the users' target systems.

The Nu-Link-Me is a Debug Adaptor, which connects your PC's USB port to a target system (via Serial Wired Debug Port) and allows you to program and debug embedded programs on the target hardware. To use the Nu-Link-Me Debug adaptor with IAR or Keil, please refer to "Nuvoton NuMicro™ IAR ICE Driver User Manual" or "Nuvoton NuMicro™ Keil ICE Driver User Manual" for details. The two documents will be stored in the local hard disk when each is installed.

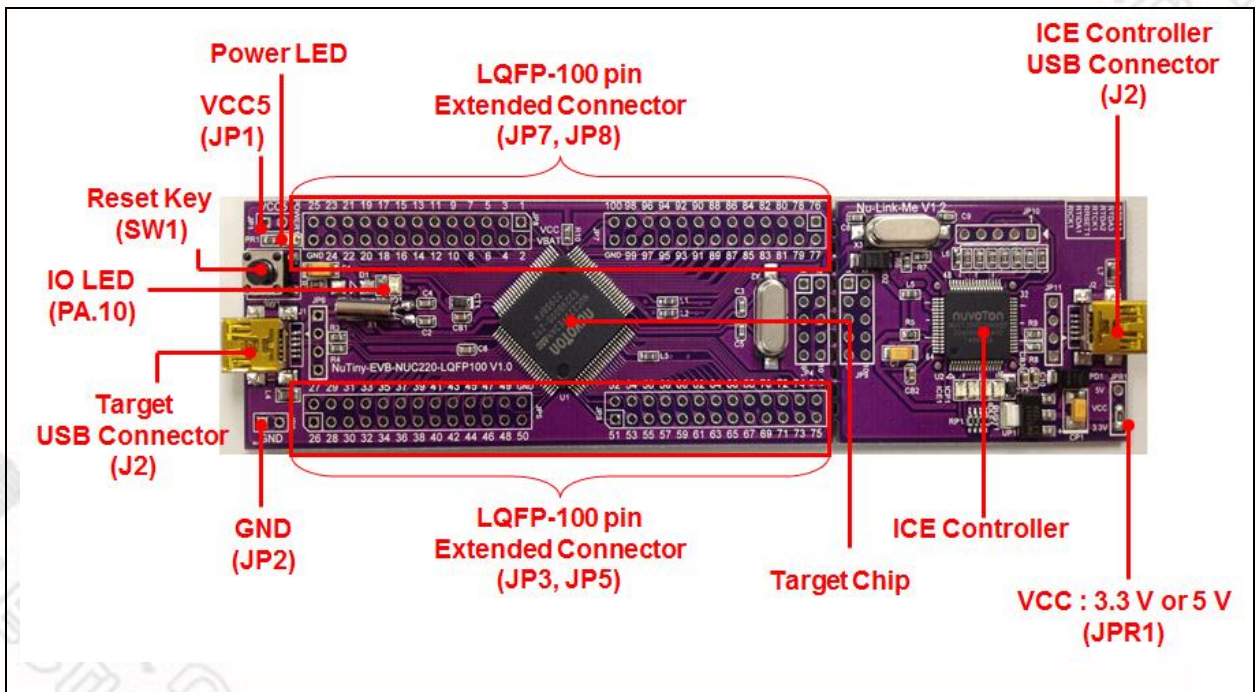

Figure 2-1 NuTiny-SDK-NUC220 PCB Board

2.1 NuTiny-SDK-NUC220 Jumper Description

2.1.1 Power Settings

- **JP1**: VCC5 Voltage connector in NuTiny-EVB-NUC220
- **J2**: USB port in Nu-Link-Me
- **JPR1**: Select 5V or 3V for system power
- **J1**: USB port in NuTiny-EVB-NUC220

POWER model	J1 USB port	J2 USB port	JP2 VCC5	MCU Voltage
Model 1	Connect to PC	X	DC 5V output	DC 5V
Model 2	X	Connect to PC	DC 5V output	DC 5V
Model 3	X	X	DC 2.8-5.5V input	Voltage by VCC input

X: Unused.

2.1.2 Debug Connectors

- **JP4**: Connector in target board (NuTiny-EVB-NUC220) for connecting with Nuvoton ICE adaptor (Nu-Link-Me)
- **JP9**: Connector in ICE adaptor (Nu-Link-Me) for connecting with a target board (e.g. NuTiny-EVB-NUC220)

2.1.3 USB Connectors

- **J1**: Mini USB Connector in NuTiny-EVB-NUC220 for application use
- **J2**: Mini USB Connector in Nu-Link-Me connected to a PC USB port

2.1.4 Extended Connectors

- **JP3, JP5, JP7 and JP8**: Show all chip pins in NuTiny-EVB-NUC220

2.1.5 Buttons

- **SW1**: Reset button in NuTiny-EVB-NUC220

2.1.6 Power Connectors

- **JP2**: VDD33 connector in NuTiny-EVB-NUC220
- **JP3**: GND connector in NuTiny-EVB-NUC220

2.1.7 Power Jumpers

- **JP1**: VCC connector in NuTiny-EVB-NUC220
- **JP2**: GND connector in NuTiny-EVB-NUC220



2.2 Pin Assignment for Extended Connectors

The NuTiny-EVB-NUC220 provides the NUC220KE3BN target chip on board and the extended connectors (**JP3**, **JP5**, **JP7** and **JP8**) for LQFP100-pin

Pin	Pin Name	Pin	Pin Name	Pin	Pin Name	Pin	Pin Name
01	PE15	26	PE8	51	PE4	76	PA5
02	PE14	27	PE7	52	PE3	77	PA6
03	PE13	28	VBUS	53	PE2	78	PA7
04	PB14	29	VDD33	54	PE1	79	Vref
05	PB13	30	D-	55	PE0	80	AVDD
06	VBAT	31	D+	56	PC13	81	PD0
07	X32O	32	PB0	57	PC12	82	PD1
08	X32I	33	PB1	58	PC11	83	PD2
09	PA11	34	PB2	59	PC10	84	PD3
10	PA10	35	PB3	60	PC9	85	PD4
11	PA9	36	PD6	61	PC8	86	PD5
12	PA8	37	PD7	62	PA15	87	PC7
13	PD8	38	PD14	63	PA14	88	PC6
14	PD9	39	PD15	64	PA13	89	PC15
15	PD10	40	PC5	65	PA12	90	PC14
16	PD11	41	PC4	66	ICE_DAT	91	PB15
17	PD12	42	PC3	67	ICE_CK	92	XT1_Out
18	PD13	43	PC2	68	VDD	93	XT1_In
19	PB4	44	PC1	69	VSS	94	/RESET
20	PB5	45	PC0	70	AVSS	95	VSS
21	PB6	46	PE6	71	PA0	96	VDD
22	PB7	47	PE5	72	PA1	97	PS2DAT
23	LDO	48	PB11	73	PA2	98	PS2CLK
24	VDD	49	PB10	74	PA3	99	PVSS
25	VSS	50	PB9	75	PA4	10	PB8

Table 2-1 NUC220VE3AN LQFP 100-pin Assignment for Extended Connectors

2.3 NuTiny-SDK-NUC220 PCB Placement

The following figure shows the NuTiny-SDK-NUC220 PCB placement.

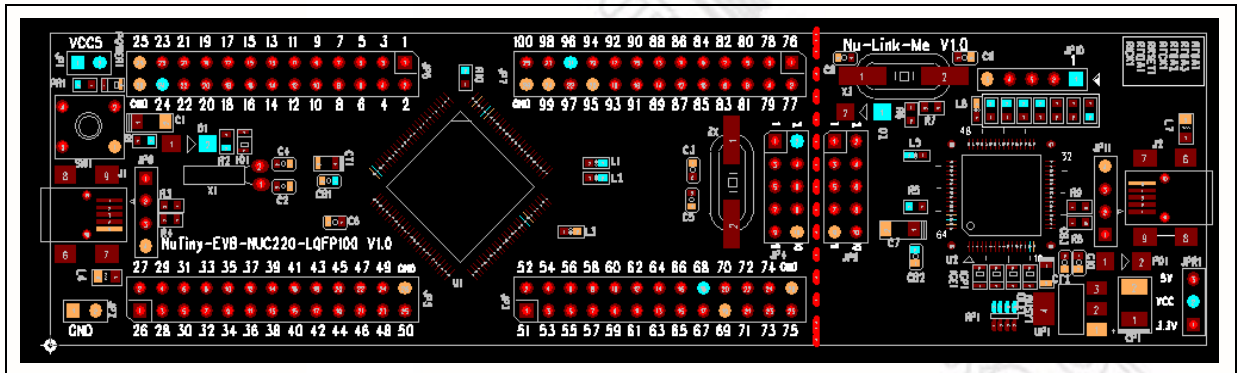

Figure 2-2 NuTiny-SDK-NUC220 PCB Placement

3 Starting to Use NuTiny -SDK-NUC220 on the Keil μ Vision[®] IDE

3.1 Downloading and Installing Keil μ Vision[®] IDE Software

Please connect to the Keil company website (<http://www.keil.com>) to download the Keil μ Vision[®] IDE and install the RVMDK.

3.2 Downloading and Installing Nuvoton Nu-Link Driver

Please connect to Nuvoton NuMicro[™] website (<http://www.nuvoton.com/NuMicro>) to download the “NuMicro[™] Keil μ Vision[®] IDE driver” file. Please refer to *section 6.1* for the detailed download flow. After the Nu-Link driver is downloaded, please unzip the file and execute the “Nu-Link_Keil_Driver.exe” to install the driver.

3.3 Hardware Setup

The hardware setup is shown in the following figure.

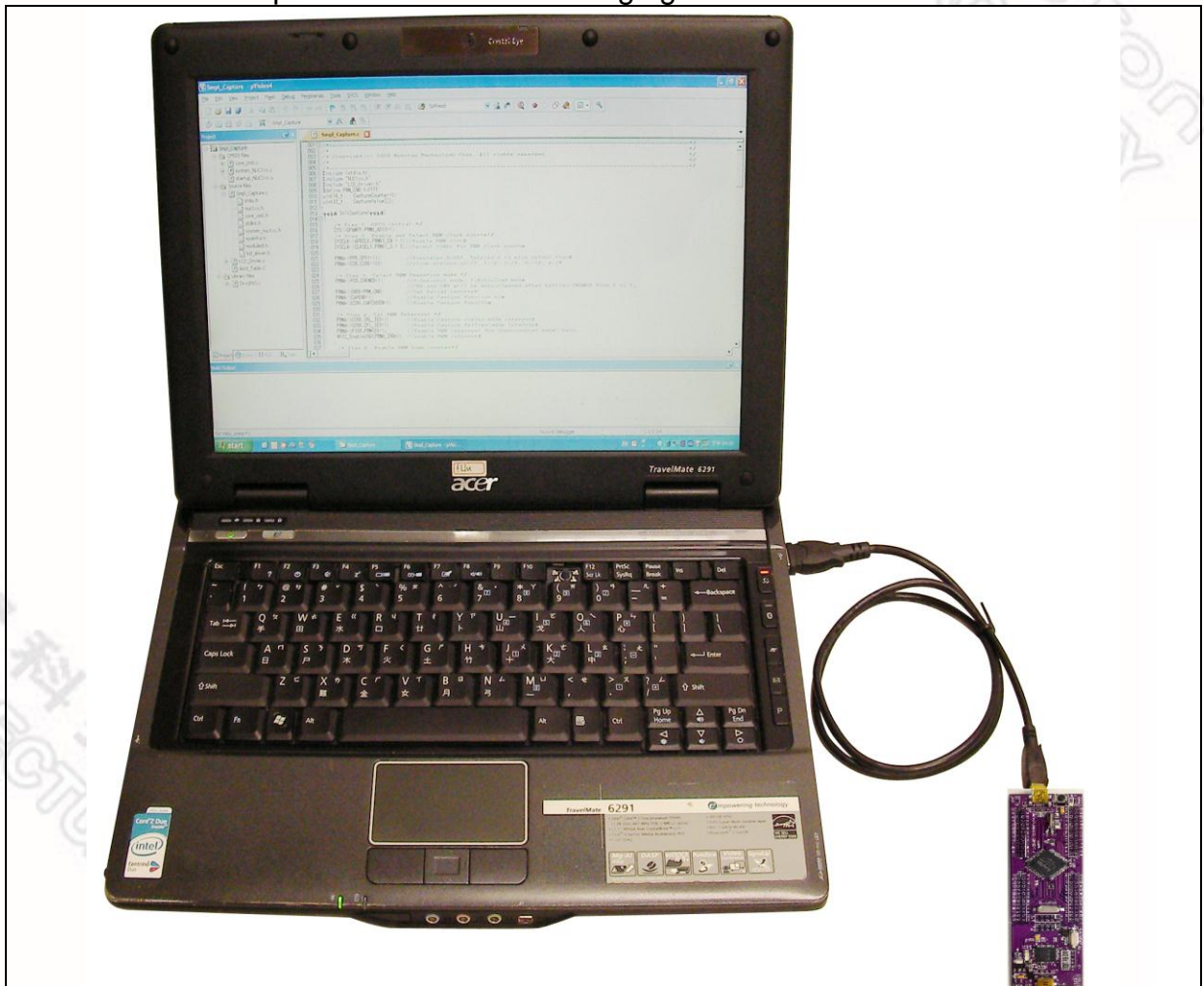

Figure 3-1 NuTiny-SDK-NUC220 Hardware Setup

3.4 SmpL_NuTiny-NUC220 Program

The example, as shown in the directory of *Figure 3-2*, demonstrates the download and debugging of an application on a NuTiny-SDK-NUC220 board. The example file can be downloaded from Nuvoton NuMicro™ website as described in 6.3 *Downloading NuMicro™ NUC220 series BSP Software Library....*

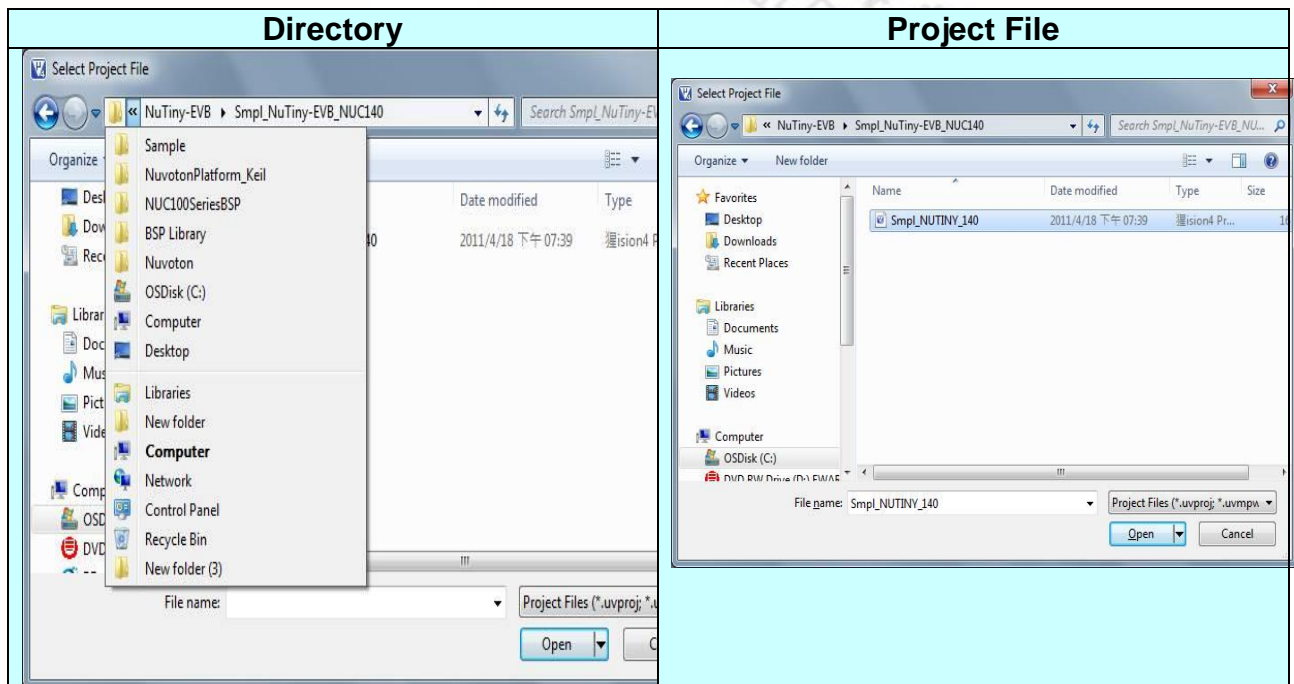

Figure 3-2 SmpL_NuTiny_200 Example Directory

To use this example:

The PA.10 LED will toggle on the NuTiny-EVB-NUC220 board.

- **Start pVision®**
- **Project-Open**
Open the SmpL_NuTiny_200.uvproj project file
- **Project - Build**
Compile and link the SmpL_NuTiny_200 application
- **Flash – Download**
Program the application code into on-chip Flash ROM

- **Start Debug mode**
When using the debugger commands, you may:
 - ◆ Review variables in the watch window
 - ◆ Single step through code
 - ◆ Reset the device
 - ◆ Run the application

4 Starting to Use NuTiny-SDK-NUC220 on the IAR Embedded Workbench

4.1 Downloading and Installing IAR Embedded Workbench Software

Please connect to IAR company website (<http://www.iar.com>) to download the IAR Embedded Workbench and install the EWARM.

4.2 Downloading and Installing Nuvoton Nu-Link Driver

Please connect to Nuvoton Company NuMicro™ website (<http://www.nuvoton.com/NuMicro>) to download the “NuMicro™ IAR ICE Driver User Manual” file. Please refer to *section 6.2* for the detailed download flow. When the Nu-Link driver has been well downloaded, please unzip the file and execute the “Nu-Link_IAR_Driver.exe” to install the driver.

4.3 Hardware Setup

The hardware setup is shown in the following figure.



Figure 4-1 NuTiny- SDK-NUC220 Hardware Setup

4.4 Smpl_NuTiny-NUC220 Program

The example, as shown in the directory of *Figure 4-2*, demonstrates the download and debugging of an application on a NuTiny-SDK-NUC220 board. The example file can be downloaded from Nuvoton NuMicro™ website as described in 6.3 *Downloading NuMicro™ NUC220 series BSP Software Library...*

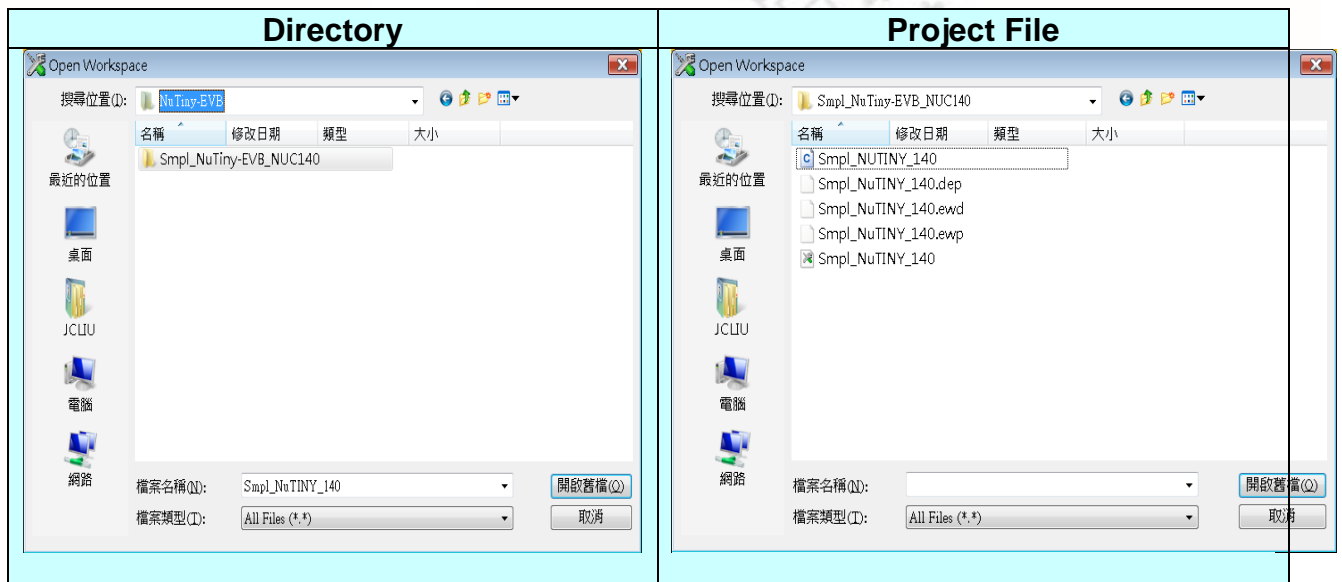

Figure 4-2 Smpl_NuTiny-NUC220 Example Directory

To use this example:

The PA.10 LED will toggle on the NuTiny-EVB-NUC220 board.

- **Start IAR Embedded Workbench**
- **File-Open-Workspace**
Open the NuTiny-EVB-NUC220.eww workspace file
- **Project - Make**
Compile and link the NuTiny-EVB-NUC220 application
- **Project – Download and Debug**
Program the application code into on-chip Flash ROM
 - ◆ Single step through code
 - ◆ Reset the device
 - ◆ Run the application

6 Downloading NuMicro™ Related Files from Nuvoton Website

6.1 Downloading NuMicro™ Keil μVision® IDE Driver

<p>Step1</p>	<p>Visit the Nuvoton NuMicro™ website: http://www.nuvoton.com/NuMicro</p>
<p>Step2</p>	<p>The screenshot shows the Nuvoton website homepage. The navigation bar includes 'Products', 'Applications', 'Support', 'Foundry Service', 'Buy', 'myNuvoton', and 'About Nuvoton'. The 'Support' dropdown menu is open, showing options like 'Learning', 'Product Related Information', 'Tool & Software', 'Reference Design', 'FAQ', 'Sales Support', 'Technical Support', and 'Forum'. The 'Tool & Software' option is highlighted with a red dashed box. A yellow callout bubble with a red arrow points to this option, containing the text: "Click here to enter Tool & Software."</p>
<p>Step3</p>	<p>The screenshot shows the 'Development Tool Hardware' page on the Nuvoton website. The left sidebar menu has 'Software' highlighted with a red dashed box. A yellow callout bubble with a red arrow points to this menu item, containing the text: "Click here to enter Device Driver and Software Library." The main content area features a diagram with three columns: 'Code Development' (showing an evaluation board and Keil RVMKD), 'Mass Production' (showing on-line and off-line in-circuit programming), and 'Upgrade' (showing in-system programming). A 'Customer Target Board' is also shown.</p>

Step4

Programmer Software Tools Package

File name	Description	Version	Date
ICP Programming Tool V1.25.6287.zip Revision History	NuMicro ICP tool & user manual	V1.25.6287	2014-01-16
ISP Programming Tool V1.44.zip Revision History	NuMicro ISP Programming Tool & user manual	V1.44	2014-01-20
NuGang Programmer V6.21.zip Revision History	NuGang Programmer software & user manual	V6.21	2014-01-24

Nu-Link Driver

File name	Description	Version	Date
Nu-Link Driver for Keil RVMDK V1.25.6287.zip Revision History	This driver is to support Nu-Link to work under Keil RVMDK Development Environment for all NuMicro Family Devices.	V1.25.6287	2014-01-16
Nu-Link Driver for IAR EWARM V1.25.6287.zip Revision History	This driver is to support Nu-Link to work under IAR EWARM Development Environment for all NuMicro Family Devices.	V1.25.6287	2014-01-16

User Feedback ↑ TOP

Step5 Download the NuMicro™ Keil μVision® IDE driver.

Click here to download the file.

新唐科技 NUVOTON
INTELLECTUAL PROPERTY

6.2 Downloading NuMicro™ IAR EWARM Driver

<p>Step1</p>	<p>Visit the Nuvoton NuMicro™ website: http://www.nuvoton.com/NuMicro.</p>
<p>Step2</p>	<p>The screenshot shows the Nuvoton website homepage. The navigation bar includes 'Products', 'Applications', 'Support', 'Foundry Service', 'Buy', 'myNuvoton', and 'About Nuvoton'. The 'Support' dropdown menu is expanded, showing options like 'Learning', 'Product Related Information', 'Tool & Software', 'Reference Design', 'FAQ', 'Sales Support', 'Technical Support', and 'Forum'. The 'Tool & Software' option is highlighted with a red dashed box. A yellow callout bubble with a red arrow points to this option, containing the text: "Click here to enter Tool & Software."</p>
<p>Step3</p>	<p>The screenshot shows the 'Development Tool Hardware' page on the Nuvoton website. The left sidebar contains a list of links: 'Learning', 'Product Related Information', 'Tool & Software', 'Development Tool Hardware', 'Development Kit', 'Learning Board', 'Programmer', 'Software', 'Third Party Tool', 'Reference Design', 'FAQ', 'Sales Support', 'Technical Support', and 'Forum'. The 'Software' link is highlighted with a red dashed box. A yellow callout bubble with a red arrow points to this link, containing the text: "Click here to enter Device Driver and Software Library."</p>

Step4	<p>Programmer Software Tools Package</p> <table border="1"> <thead> <tr> <th>File name</th> <th>Description</th> <th>Version</th> <th>Date</th> </tr> </thead> <tbody> <tr> <td> ICP Programming Tool V1.25.6287.zip Revision History </td> <td>NuMicro ICP tool & user manual</td> <td>V1.25.6287</td> <td>2014-01-16</td> </tr> <tr> <td> ISP Programming Tool V1.44.zip Revision History </td> <td>NuMicro ISP Programming Tool & user manual</td> <td>V1.44</td> <td>2014-01-20</td> </tr> <tr> <td> NuGang Programmer V6.21.zip Revision History </td> <td>NuGang Programmer software & user manual</td> <td>V6.21</td> <td>2014-01-24</td> </tr> </tbody> </table>	File name	Description	Version	Date	ICP Programming Tool V1.25.6287.zip Revision History	NuMicro ICP tool & user manual	V1.25.6287	2014-01-16	ISP Programming Tool V1.44.zip Revision History	NuMicro ISP Programming Tool & user manual	V1.44	2014-01-20	NuGang Programmer V6.21.zip Revision History	NuGang Programmer software & user manual	V6.21	2014-01-24
	File name	Description	Version	Date													
ICP Programming Tool V1.25.6287.zip Revision History	NuMicro ICP tool & user manual	V1.25.6287	2014-01-16														
ISP Programming Tool V1.44.zip Revision History	NuMicro ISP Programming Tool & user manual	V1.44	2014-01-20														
NuGang Programmer V6.21.zip Revision History	NuGang Programmer software & user manual	V6.21	2014-01-24														
<p>Nu-Link Driver</p> <table border="1"> <thead> <tr> <th>File name</th> <th>Description</th> <th>Version</th> <th>Date</th> </tr> </thead> <tbody> <tr> <td> Nu-Link Driver for Keil RVMDK V1.25.6287.zip Revision History </td> <td>This driver is to support Nu-Link to work under Keil RVMDK Development Environment for all NuMicro Family Devices.</td> <td>V1.25.6287</td> <td>2014-01-16</td> </tr> <tr> <td> Nu-Link Driver for IAR EWARM V1.25.6287.zip Revision History </td> <td>This driver is to support Nu-Link to work under IAR EWARM Development Environment for all NuMicro Family Devices.</td> <td>V1.25.6287</td> <td>2014-01-16</td> </tr> </tbody> </table> <p style="text-align: center;"> </p> <p style="text-align: right;"> User Feedback ↑ TOP </p>	File name	Description	Version	Date	Nu-Link Driver for Keil RVMDK V1.25.6287.zip Revision History	This driver is to support Nu-Link to work under Keil RVMDK Development Environment for all NuMicro Family Devices.	V1.25.6287	2014-01-16	Nu-Link Driver for IAR EWARM V1.25.6287.zip Revision History	This driver is to support Nu-Link to work under IAR EWARM Development Environment for all NuMicro Family Devices.	V1.25.6287	2014-01-16					
File name	Description	Version	Date														
Nu-Link Driver for Keil RVMDK V1.25.6287.zip Revision History	This driver is to support Nu-Link to work under Keil RVMDK Development Environment for all NuMicro Family Devices.	V1.25.6287	2014-01-16														
Nu-Link Driver for IAR EWARM V1.25.6287.zip Revision History	This driver is to support Nu-Link to work under IAR EWARM Development Environment for all NuMicro Family Devices.	V1.25.6287	2014-01-16														
Step5	Download the NuMicro™ IAR EWARM driver.																

新唐科技 NUVOTON
 INTELLECTUAL PROPERTY

6.3 Downloading NuMicro™ NUC220 series BSP Software Library

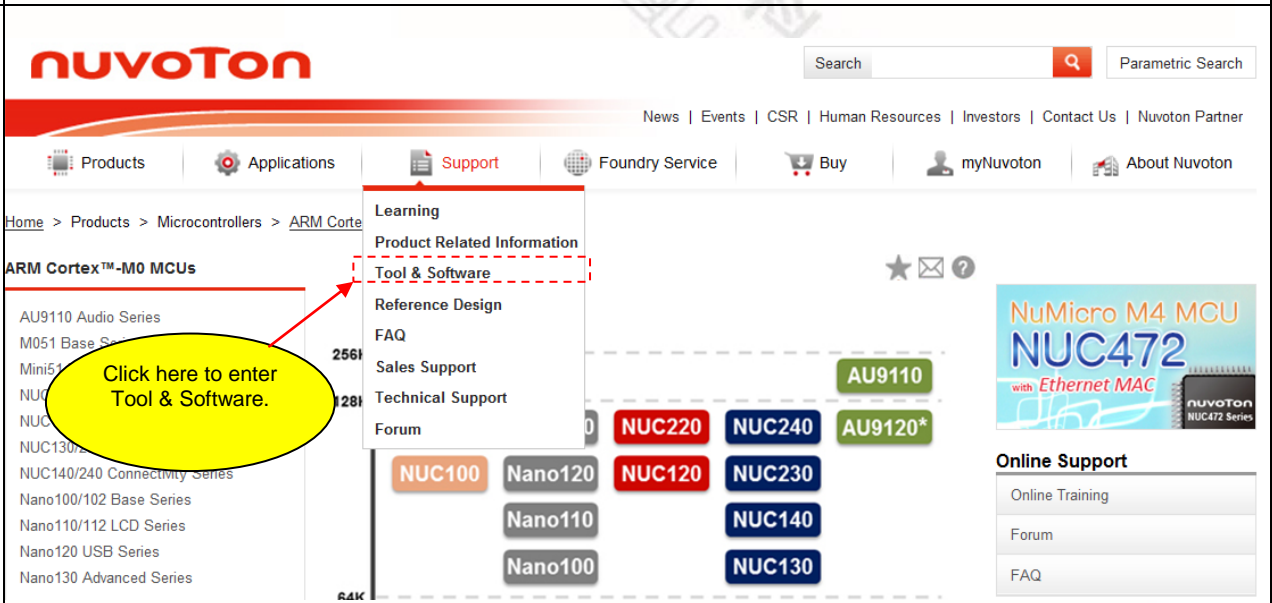
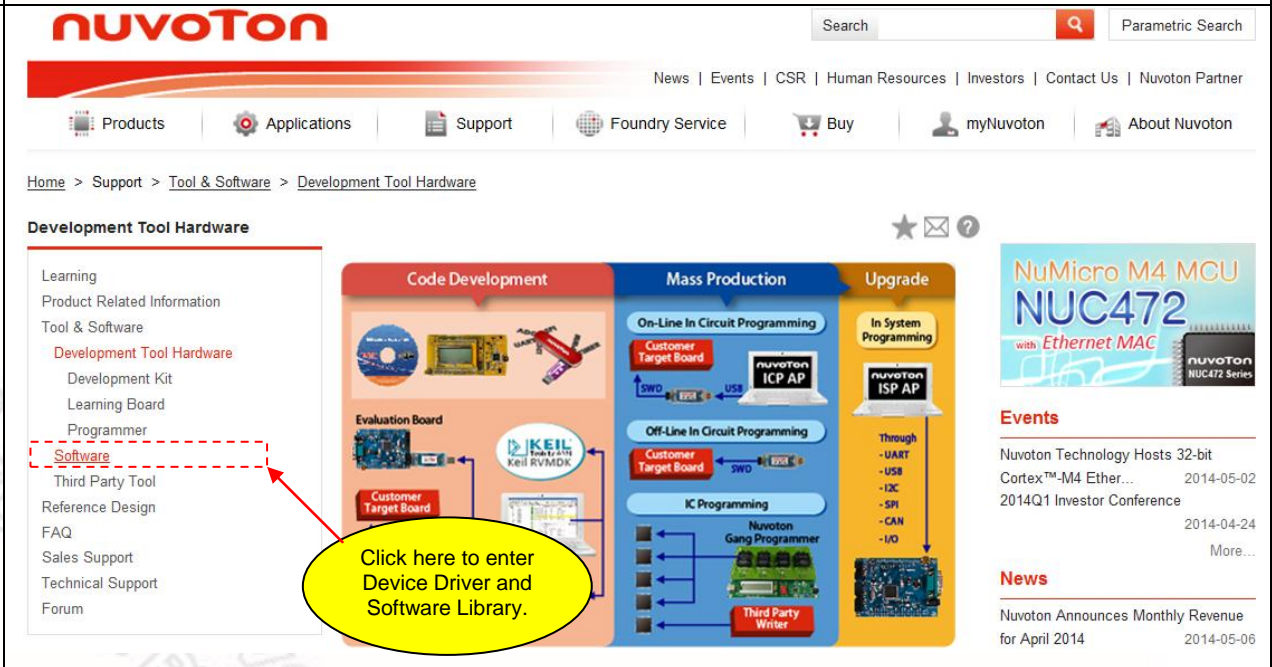
<p>Step1</p>	<p>Visit the Nuvoton NuMicro™ website: http://www.nuvoton.com/NuMicro.</p>
<p>Step2</p>	 <p>The screenshot shows the Nuvoton website's navigation menu. The 'Support' menu is expanded, and 'Tool & Software' is highlighted with a red dashed box. A yellow callout bubble with a red arrow points to this option, containing the text: "Click here to enter Tool & Software."</p>
<p>Step3</p>	 <p>The screenshot shows the 'Development Tool Hardware' page on the Nuvoton website. The 'Software' option in the left-hand navigation menu is highlighted with a red dashed box. A yellow callout bubble with a red arrow points to this option, containing the text: "Click here to enter Device Driver and Software Library."</p>
<p>Step 3</p>	<p>Download the NuMicro™ NUC220 series software library.</p>

7 Revision History

Revision	Date	Description
1.00	Jan. 23, 2013	Initially issued.

Important Notice

Nuvoton products are not designed, intended, authorized or warranted for use as components in systems or equipment intended for surgical implantation, atomic energy control instruments, airplane or spaceship instruments, transportation instruments, traffic signal instruments, combustion control instruments, or for other applications intended to support or sustain life. Further more, Nuvoton products are not intended for applications wherein failure of Nuvoton products could result or lead to a situation wherein personal injury, death or severe property or environmental damage could occur.

Nuvoton customers using or selling these products for use in such applications do so at their own risk and agree to fully indemnify Nuvoton for any damages resulting from such improper use or sales.

Please note that all data and specifications are subject to change without notice. All the trademarks of products and companies mentioned in this datasheet belong to their respective owners.