

**ARM[®] Cortex[®]-M
32-bit Microcontroller**

**NuMaker-M251KG
User Manual
NuMicro[®] M251 Series**

The information described in this document is the exclusive intellectual property of Nuvoton Technology Corporation and shall not be reproduced without permission from Nuvoton.

Nuvoton is providing this document only for reference purposes of NuMicro microcontroller based system design. Nuvoton assumes no responsibility for errors or omissions.

All data and specifications are subject to change without notice.

For additional information or questions, please contact: Nuvoton Technology Corporation.

www.nuvoton.com

Table of Contents

1 Overview 7

2 Features 8

3 Hardware Configuration 9

 3.1 Front View..... 9

 3.2 Rear View 10

 3.3 Extension Connectors..... 11

 3.3.1 Pin Assignment for Extension Connectors..... 11

 3.3.2 Arduino UNO Compatible Extension Connectors 17

 3.4 Power Supply Configuration 19

 3.4.1 VIN Power Source 19

 3.4.2 5 V Power Sources 20

 3.4.3 3.3 V Power Sources..... 20

 3.4.4 1.8V Power Sources 20

 3.4.5 Power Connectors 21

 3.4.6 USB Connectors 21

 3.4.7 Power Switches 21

 3.4.8 Power Supply Models 22

 3.5 External Reference Voltage Connector 25

 3.6 Voltage Adjustable Interface(VAI) Connector 25

 3.7 Battery Voltage (V_{BAT}) Connector 25

 3.8 Ammeter Connector 25

 3.9 Push-Buttons 26

 3.10 LEDs 26

 3.11 Nu-Link2-Me 26

 3.11.1 VCOM Switches..... 26

 3.11.2 Status LEDs 27

4 Quick Start 28

 4.1 Toolchains Supporting 28

 4.2 Nuvoton Nu-Link Driver Installation 28

 4.3 BSP Firmware Download 30

 4.4 Hardware Setup..... 30

 4.5 Find the Example Project..... 32

 4.6 Execute the Project under Toolchains..... 32

- 4.6.1 Keil MDK 32
- 4.6.2 IAR EWARM..... 36
- 4.6.3 NuEclipse 37
- 5 NuMaker-M251KG Schematics 44
 - 5.1 Nu-Link2-Me44
 - 5.2 M251 platform45
 - 5.3 Extension Connector46
 - 5.5 PCB Placement47
- 6 REVISION HISTORY 48

List of Figures

Figure 1-1 NuMaker-M251KG Board 7

Figure 3-1 Front View of NuMaker-M251KG 9

Figure 3-2 Rear View of NuMaker-M251KG 10

Figure 3-3 M251KG6AE Extension Connectors 11

Figure 3-4 Arduino UNO Compatible Extension Connectors..... 17

Figure 3-5 External Power Supply Sources on Nu-Link2-Me 22

Figure 3-6 External Power Supply Sources on M251 platform 23

Figure 3-7 Separate the Nu-Link2-Me from NuMaker-M251KG 24

Figure 3-8 Wiring between Ammeter Connector and Ammeter..... 25

Figure 4-1 Nu-Link USB Driver Installation Setup..... 28

Figure 4-2 Nu-Link USB Driver Installation 29

Figure 4-3 Open VCOM Function 30

Figure 4-4 ICE USB Connector..... 30

Figure 4-5 Device Manger..... 31

Figure 4-6 PuTTY Session Setting..... 31

Figure 4-7 Template Project Folder Path..... 32

Figure 4-8 Warning Message of “Device not found” 32

Figure 4-9 Project File Migrate to Version 5 Format..... 33

Figure 4-10 Debugger Setting in Options Window..... 33

Figure 4-11 Programming Setting in Options Window..... 34

Figure 4-12 Compile and Download the Project 34

Figure 4-13 Keil MDK Debug Mode 35

Figure 4-14 Debug Message on Serial Port Terminal Windows..... 35

Figure 4-15 IAR EWARM Window 36

Figure 4-16 Compile and Download the Project 36

Figure 4-17 IAR EWARM Debug Mode 37

Figure 4-18 Debug Message on Serial Port Terminal Windows..... 37

Figure 4-19 Import the Project in NuEclipse 38

Figure 4-20 Import Projects Windows..... 38

Figure 4-21 Open Project Properties Window 39

Figure 4-22 Project Properties Settings 39

Figure 4-23 Build Project..... 40

Figure 4-24 Open Debug Configuration..... 40

Figure 4-25 Main Tab Configuration 41

Figure 4-26 Debugger Tab Configuration 41

Figure 4-27 Startup Tab Configuration 42

Figure 4-28 NuEclipse Debug Mode 43

Figure 4-29 Debug Message on Serial Port Terminal Windows..... 43

Figure 5-1 Nu-Link2-Me Circuit 44

Figure 5-2 M251 platform Circuit..... 45

Figure 5-3 Extension Connectors Circuit 46

Figure 5-5 Front Placement 47

Figure 5-6 Rear Placement 47

List of Tables

Table 3-1 Extension Connectors..... 11

Table 3-2 M251KG6AE Full-pin Extension Connectors and GPIO Function List 16

Table 3-3 Arduino UNO Extension Connectors and M251KG6AE Mapping GPIO List 18

Table 3-4 Vin Power Source 19

Table 3-5 5V Power Sources 20

Table 3-6 3.3 V Power Sources 20

Table 3-7 1.8V Power Sources 20

Table 3-8 Power Connectors 21

Table 3-9 USB Connectors 21

Table 3-10 Power Switches 21

Table 3-11 Supply External Power through Nu-Link2-Me 22

Table 3-12 Supply External Power for M251 platform 24

Table 3-13 External Reference Voltage Connector 25

Table 3-14 Voltage Adjustable Interface Connector 25

Table 3-15 Battery Voltage Interface Connector..... 25

Table 3-16 Ammeter Connector..... 25

Table 3-17 Push-Buttons 26

Table 3-18 LEDs 26

Table 3-19 VCOM Function of Nu-Link2-Me..... 26

Table 3-20 Operation Status LED Patterns 27

1 OVERVIEW

The NuMaker-M251KG is a development board for Nuvoton NuMicro® M251 microcontrollers module. The NuMaker-M251KG consists of two parts: a M251 platform and an on-board Nu-Link2-Me debugger and programmer. The NuMaker-M251KG is designed for project evaluation, prototype development and validation with power consumption monitoring function.

The M251 platform is based on NuMicro® M251KG6AE. For the development flexibility, the M251 platform provides the extension connectors of M251KG6AE, the Arduino UNO compatible headers and able to adopt multiple power supply. Furthermore, the Nuvoton-designed ammeter connector can measure the power consumption instantly, which is essential for the prototype evaluation.

In addition to the M251 platform, there is an attached on-board debugger and programmer “Nu-Link2-Me”. The Nu-Link2-Me supports on-chip debugging, online and offline ICP programming via SWD interface. The Nu-Link2-Me supports virtual COM (VCOM) port for printing debug messages on PC. Besides, the programming status could be shown on the built-in LEDs. Lastly, the Nu-Link2-Me could be detached from the development board and becoming a stand-alone mass production programmer.

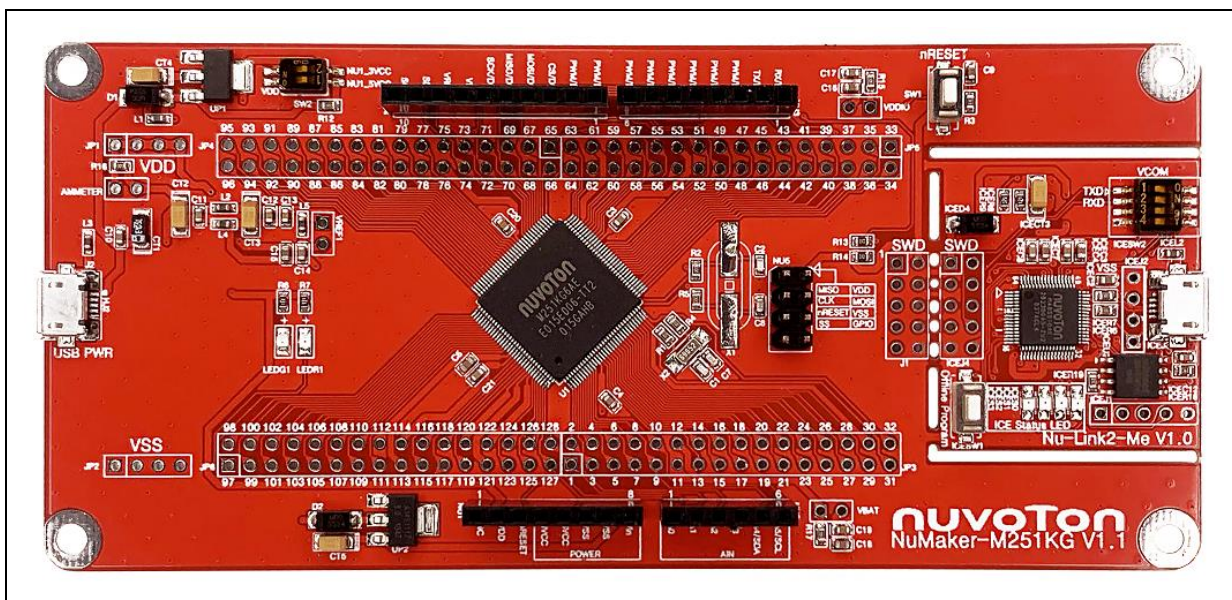

Figure 1-1 NuMaker-M251KG Board

2 FEATURES

- NuMicro® M251KG6AE microcontroller with function compatible with:
 - ◆ M251SG6AE
 - ◆ M251LG6AE
- M251KG6AE extension connectors
- Arduino UNO compatible extension connectors
- Ammeter connector for measuring the microcontroller's power consumption
- Fixable board power supply:
 - ◆ External V_{DD} power connector
 - ◆ Arduino UNO compatible extension connector V_{in}
 - ◆ USB PWR connector on M251 platform
 - ◆ ICE USB connector on Nu-Link2-Me
- On-board Nu-Link2-Me debugger and programmer:
 - ◆ Debug through SWD interface
 - ◆ On-line/off-line programming
 - ◆ Virtual COM port function

3 HARDWARE CONFIGURATION

3.1 Front View

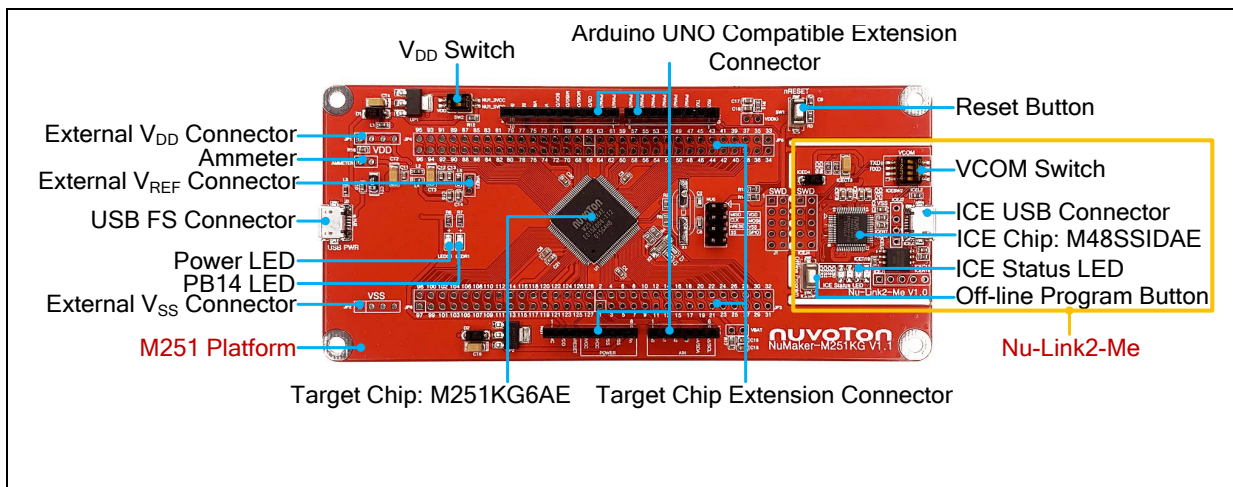

Figure 3-1 Front View of NuMaker-M251KG

Figure 3-1 shows the main components and connectors from the front side of NuMaker-M251KG. The following lists components and connectors from the front view:

- Target Chip: M251KG6AE(U1)
- USB PWR Connector(J2)
- Arduino UNO Compatible Extension Connectors (NU1, NU2, NU3, NU4)
- M251 Extension Connectors (JP3, JP4, JP5 and JP6)
- External V_{DD} Power Connector(JP1)
- External V_{SS} Power Connector(JP2)
- External V_{REF} Connector(VREF1)
- VDD Switch(SW2)
- Ammeter Connector(AMMETER)
- Reset Button(SW1)
- Power LED and PB14 LED(LEDG1 and LEDR1)
- Nu-Link2-Me
 - ◆ VCOM Switch
 - ◆ ICE Chip: M48SSIDAE(ICEU2)
 - ◆ ICE USB Connector(ICEJ3)
 - ◆ ICE Status LED(ICES0,ICES1, ICES2, ICES3)
 - ◆ Off-line Program Button(ICESW1)

3.2 Rear View

Figure 3-2 shows the main components and connectors from the rear side of NuMaker-M251KG.

The following lists components and connectors from the rear view:

- Nu-Link2-Me
 - ◆ MCUVCC Power Switch (ICEJPR1)
 - ◆ ICEVCC Power Switch (ICEJPR2)

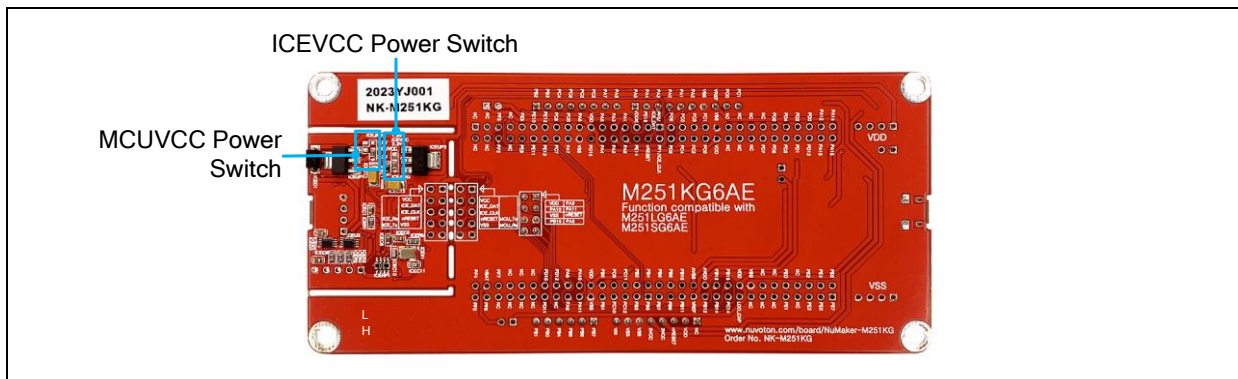

Figure 3-2 Rear View of NuMaker-M251KG

3.3 Extension Connectors

Table 3-1 presents the extension connectors.

Connector	Description
JP3, JP4, JP5 and JP6	Full pins extension connectors on the NuMaker-M251KG.
NU1, NU2, NU3 and NU4	Arduino UNO compatible pins on the NuMaker-M251KG.

Table 3-1 Extension Connectors

3.3.1 Pin Assignment for Extension Connectors

The NuMaker-M251KG provides the M251KG6AE target chip onboard and full pins extension connectors (JP3, JP4, JP5 and JP6). The Figure 3-3 shows the M251KG6AE extension connectors.

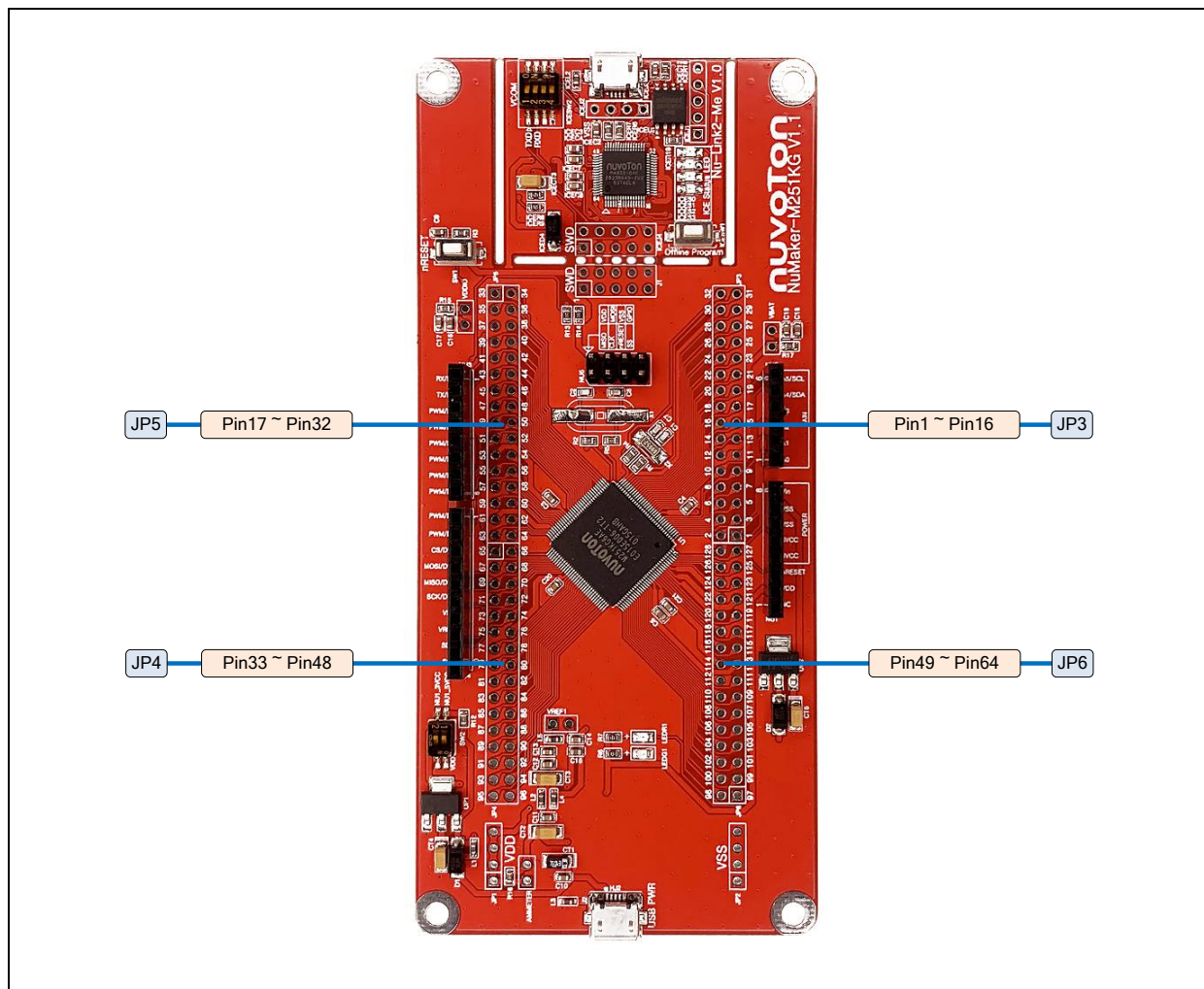

Figure 3-3 M251KG6AE Extension Connectors

Header		M251KG6AE	
		Pin No.	Function
JP3	JP3.1	1	PB.5/EADC0_CH5/ACMP1_N/EBI_ADR0/I2C0_SCL/USCI1_CTL0/SC0_CLK/PWM0_CH0/PSIO0_CH4/UART2_TXD/TM0/INT0
	JP3.2	2	PB.4/EADC0_CH4/ACMP1_P1/EBI_ADR1/I2C0_SDA/USCI1_CTL1/SC0_DAT/PWM0_CH1/PSIO0_CH5/UART2_RXD/TM1/INT1
	JP3.3	3	PB.3/EADC0_CH3/ACMP0_N/EBI_ADR2/I2C1_SCL/UART1_TXD/USCI1_DAT1/SC0_RST/PWM0_CH2/PSIO0_CH6/PWM0_BRAKE0/TM2/INT2
	JP3.4	4	PB.2/EADC0_CH2/ACMP0_P1/OPA0_O/EBI_ADR3/I2C1_SDA/UART1_RXD/USCI1_DAT0/SC0_PWR/PWM0_CH3/PSIO0_CH7/TM3/INT3
	JP3.5	5	PC.12/EBI_ADR4/UART0_TXD/I2C0_SCL/SC0_nCD/PWM1_CH0/ACMP0_O
	JP3.6	6	PC.11/EBI_ADR5/UART0_RXD/I2C0_SDA/PWM1_CH1/ACMP1_O
	JP3.7	7	PC.10/EBI_ADR6/PWM1_CH2
	JP3.8	8	PC.9/EBI_ADR7/PWM1_CH3
	JP3.9	9	PB.1/EADC0_CH1/OPA0_N/EBI_ADR8/UART2_TXD/USCI1_CLK/I2C1_SCL/QSPI0_MISO1/PWM0_CH4/PWM1_CH4/PWM0_BRAKE0
	JP3.10	10	PB.0/EADC0_CH0/OPA0_P/EBI_ADR9/UART2_RXD/SPI0_I2SMCLK/I2C1_SDA/QSPI0_MOSI1/PWM0_CH5/PWM1_CH5/PWM0_BRAKE1
	JP3.11	11	V _{SS}
	JP3.12	12	V _{DD}
	JP3.13	13	PA.11/ACMP0_P0/EBI_nRD/USCI0_CLK/BPWM0_CH0/TM0_EXT
	JP3.14	14	PA.10/ACMP1_P0/EBI_nWR/USCI0_DAT0/BPWM0_CH1/TM1_EXT/DAC0_ST
	JP3.15	15	PA.9/EBI_MCLK/USCI0_DAT1/UART1_TXD/BPWM0_CH2/TM2_EXT
	JP3.16	16	PA.8/EBI_ALE/USCI0_CTL1/UART1_RXD/BPWM0_CH3/TM3_EXT/INT4
	JP3.17	17	NC
	JP3.18	18	PD.12/EBI_nCS0/UART2_RXD/BPWM0_CH5/CLKO/EADC0_ST/INT5
	JP3.19	19	PD.11/EBI_nCS1/UART1_TXD
	JP3.20	20	PD.10/EBI_nCS2/UART1_RXD
	JP3.21	21	NC
	JP3.22	22	NC
	JP3.23	23	NC
	JP3.24	24	NC
	JP3.25	25	NC
	JP3.26	26	NC
	JP3.27	27	NC
	JP3.28	28	PF.7/EBI_ADR18/SC0_DAT/SPI0_MISO
	JP3.29	29	PF.6/EBI_ADR19/SC0_CLK/SPI0_MOSI/EBI_nCS0/TAMPER0

Header		M251KG6AE	
		Pin No.	Function
	JP3.30	30	V _{BAT}
	JP3.31	31	PF.5/UART2_RXD/UART2_nCTS/PWM0_CH0/BPWM0_CH4/X32_IN/EADC0_ST
	JP3.32	32	PF.4/UART2_TXD/UART2_nRTS/PWM0_CH1/BPWM0_CH5/X32_OUT
JP5	JP5.1	33	NC
	JP5.2	34	NC
	JP5.3	35	NC
	JP5.4	36	NC
	JP5.5	37	PF.3/EBI_nCS0/UART0_TXD/I2C0_SCL/XT1_IN/BPWM1_CH0
	JP5.6	38	PF.2/EBI_nCS1/UART0_RXD/I2C0_SDA/QSPI0_CLK/XT1_OUT/BPWM1_CH1
	JP5.7	39	NC
	JP5.8	40	NC
	JP5.9	41	PE.8/EBI_ADR10/USCI1_CTL1/UART2_TXD/PWM0_CH0/PWM0_BRAKE0
	JP5.10	42	PE.9/EBI_ADR11/USCI1_CTL0/UART2_RXD/PWM0_CH1/PWM0_BRAKE1
	JP5.11	43	PE.10/EBI_ADR12/USCI1_DAT0/PWM0_CH2/PWM1_BRAKE0
	JP5.12	44	PE.11/EBI_ADR13/USCI1_DAT1/UART1_nCTS/PWM0_CH3/PWM1_BRAKE1
	JP5.13	45	PE.12/EBI_ADR14/USCI1_CLK/UART1_nRTS/PWM0_CH4
	JP5.14	46	PE.13/EBI_ADR15/I2C0_SCL/UART1_TXD/PWM0_CH5/PWM1_CH0/BPWM1_CH5
	JP5.15	47	PC.8/EBI_ADR16/I2C0_SDA/UART1_RXD/PWM1_CH1/BPWM1_CH4
	JP5.16	48	PC.7/EBI_AD9/UART0_nCTS/I2C1_SMBAL/PWM1_CH2/BPWM1_CH0/TM0/INT3
	JP5.17	49	PC.6/EBI_AD8/UART0_nRTS/I2C1_SMBSUS/PWM1_CH3/BPWM1_CH1/TM1/INT2
	JP5.18	50	PA.7/EBI_AD7/UART0_TXD/I2C1_SCL/PWM1_CH4/BPWM1_CH2/ACMP0_WLAT/TM2/INT1
	JP5.19	51	PA.6/EBI_AD6/UART0_RXD/I2C1_SDA/PWM1_CH5/BPWM1_CH3/ACMP1_WLAT/TM3/INT0
	JP5.20	52	V _{SS}
	JP5.21	53	V _{DD}
	JP5.22	54	PD.15/PSIO0_CH7/PWM0_CH5/TM3/INT1
	JP5.23	55	PA.5/QSPI0_MISO1/UART0_nCTS/UART0_TXD/I2C0_SCL/BPWM0_CH5/PWM0_CH0
	JP5.24	56	PA.4/QSPI0_MOSI1/SPI0_I2SMCLK/SC0_nCD/UART0_nRTS/UART0_RXD/I2C0_SDA/USCI2_CTL1/BPWM0_CH4/PWM0_CH1
	JP5.25	57	PA.3/QSPI0_SS/SPI0_SS/SC0_PWR/I2C0_SMBAL/UART1_TXD/I2C1_SCL/PSIO0_CH4/USCI2_CTL0/BPWM0_CH3/PWM0_CH2/CLKO/PWM1_BRAKE1
	JP5.26	58	PA.2/QSPI0_CLK/SPI0_CLK/SC0_RST/I2C0_SMBSUS/UART1_RXD/I2C1_SDA/PSIO0_CH5/USCI2_CLK/BPWM0_CH2/PWM0_CH3
	JP5.27	59	PA.1/QSPI0_MISO0/SPI0_MISO/SC0_DAT/UART0_TXD/UART1_nCTS/PSIO0_CH6/USCI2_DAT0/BPWM0_CH1/PWM0_CH4
	JP5.28	60	PA.0/QSPI0_MOSI0/SPI0_MOSI/SC0_CLK/UART0_RXD/UART1_nRTS/PSIO0_CH7/USCI2_DAT1/

Header		M251KG6AE	
		Pin No.	Function
JP5			BPWM0_CH0/PWM0_CH5/DAC0_ST
	JP5.29	61	V _{DDIO}
	JP5.30	62	PE.14/EBI_AD8/UART2_TXD/PSIO0_CH0
	JP5.31	63	PE.15/EBI_AD9/UART2_RXD/PSIO0_CH1
JP5.32	64	nRESET Note: It is recommended to use 10 kΩ pull-up resistor and 10 uF capacitor on nRESET pin.	
JP4	JP4.1	65	PF.0/UART1_TXD/I2C1_SCL/UART0_TXD/BPWM1_CH0/ICE_DAT Note: It is recommended to use 100 kΩ pull-up resistor on ICE_DAT pin.
	JP4.2	66	PF.1/UART1_RXD/I2C1_SDA/UART0_RXD/BPWM1_CH1/ICE_CLK Note: It is recommended to use 100 kΩ pull-up resistor on ICE_CLK pin.
	JP4.3	67	PD.9/EBI_AD7/UART2_nCTS/PSIO0_CH2
	JP4.4	68	PD.8/EBI_AD6/UART2_nRTS/PSIO0_CH3
	JP4.5	69	PC.5/EBI_AD5/QSPI0_MISO1/UART2_TXD/I2C1_SCL/PWM1_CH0/PSIO0_CH0
	JP4.6	70	PC.4/EBI_AD4/QSPI0_MOSI1/UART2_RXD/I2C1_SDA/PWM1_CH1/USCI2_CTL1/PSIO0_CH1
	JP4.7	71	PC.3/EBI_AD3/QSPI0_SS/UART2_nRTS/I2C0_SMBAL/PWM1_CH2/USCI2_CTL0/PSIO0_CH2
	JP4.8	72	PC.2/EBI_AD2/QSPI0_CLK/UART2_nCTS/I2C0_SMBUS/PWM1_CH3/USCI2_CLK/PSIO0_CH3
	JP4.9	73	PC.1/EBI_AD1/QSPI0_MISO0/UART2_TXD/I2C0_SCL/PWM1_CH4/USCI2_DAT0/ACMP0_O
	JP4.10	74	PC.0/EBI_AD0/QSPI0_MOSI0/UART2_RXD/I2C0_SDA/PWM1_CH5/USCI2_DAT1/ACMP1_O
	JP4.11	75	V _{SS}
	JP4.12	76	V _{DD}
	JP4.13	77	NC
	JP4.14	78	NC
	JP4.15	79	NC
	JP4.16	80	NC
	JP4.17	81	NC
	JP4.18	82	NC
	JP4.19	83	NC
	JP4.20	84	PD.7/UART1_TXD/I2C0_SCL/USCI1_CLK/PSIO0_CH4
	JP4.21	85	PD.6/UART1_RXD/I2C0_SDA/USCI1_DAT1/PSIO0_CH5
	JP4.22	86	PD.5/I2C1_SCL/USCI1_DAT0/PSIO0_CH6
	JP4.23	87	PD.4/USCI0_CTL0/I2C1_SDA/USCI1_CTL1/PSIO0_CH7
	JP4.24	88	PD.3/EBI_AD10/USCI0_CTL1/SPI0_SS/USCI1_CTL0/UART0_TXD
	JP4.25	89	PD.2/EBI_AD11/USCI0_DAT1/SPI0_CLK/UART0_RXD

Header		M251KG6AE	
		Pin No.	Function
JP4	JP4.26	90	PD.1/EBI_AD12/USCI0_DAT0/SPI0_MISO
	JP4.27	91	PD.0/EBI_AD13/USCI0_CLK/SPI0_MOSI/TM2
	JP4.28	92	PD.13/EBI_AD10/SPI0_I2SMCLK/USCI2_CTL0
	JP4.29	93	PA.12/I2C1_SCL/USCI2_DAT1/PSIO0_CH4/BPWM1_CH2
	JP4.30	94	PA.13/I2C1_SDA/USCI2_DAT0/PSIO0_CH5/BPWM1_CH3
	JP4.31	95	PA.14/UART0_TXD/USCI2_CLK/PSIO0_CH6/BPWM1_CH4
	JP4.32	96	PA.15/UART0_RXD/USCI2_CTL1/PSIO0_CH7/BPWM1_CH5
JP6	JP6.1	97	PE.7/PSIO0_CH0/PWM0_CH0/BPWM0_CH5
	JP6.2	98	PE.6/SC0_nCD/USCI0_CTL0/PSIO0_CH1/PWM0_CH1/BPWM0_CH4
	JP6.3	99	PE.5/EBI_nRD/SC0_PWR/USCI0_CTL1/PSIO0_CH2/PWM0_CH2/BPWM0_CH3
	JP6.4	100	PE.4/EBI_nWR/SC0_RST/USCI0_DAT1/PSIO0_CH3/PWM0_CH3/BPWM0_CH2
	JP6.5	101	PE.3/EBI_MCLK/SC0_DAT/USCI0_DAT0/PWM0_CH4/BPWM0_CH1
	JP6.6	102	PE.2/EBI_ALE/SC0_CLK/USCI0_CLK/USCI2_CTL0/PWM0_CH5/BPWM0_CH0
	JP6.7	103	NC
	JP6.8	104	NC
	JP6.9	105	PE.1/EBI_AD10/QSPI0_MISO0/I2C1_SCL/USCI2_DAT1
	JP6.10	106	PE.0/EBI_AD11/QSPI0_MOSI0/I2C1_SDA/USCI2_DAT0
	JP6.11	107	NC
	JP6.12	108	NC
	JP6.13	109	NC
	JP6.14	110	NC
	JP6.15	111	NC
	JP6.16	112	V _{SS}
	JP6.17	113	LDO_CAP
	JP6.18	114	V _{DD}
	JP6.19	115	PC.14/EBI_AD11/SPI0_I2SMCLK/USCI0_CTL0/QSPI0_CLK/USCI2_CLK/TM1
	JP6.20	116	PB.15/EADC0_CH15/EBI_AD12/SPI0_SS/USCI0_CTL1/UART0_nCTS/PSIO0_CH0/PWM1_CH0/TM0_EXT/PWM0_BRAKE1
	JP6.21	117	PB.14/EADC0_CH14/EBI_AD13/SPI0_CLK/USCI0_DAT1/UART0_nRTS/PSIO0_CH1/PWM1_CH1/TM1_EXT/CLKO
	JP6.22	118	PB.13/EADC0_CH13/ACMP0_P3/ACMP1_P3/EBI_AD14/SPI0_MISO/USCI0_DAT0/UART0_TXD/PSIO0_CH2/PWM1_CH2/TM2_EXT
	JP6.23	119	PB.12/EADC0_CH12/DAC0_OUT/ACMP0_P2/ACMP1_P2/EBI_AD15/SPI0_MOSI/USCI0_CLK/UART0_RXD/PSIO0_CH3/PWM1_CH3/TM3_EXT
	JP6.24	120	AV _{DD}

Header		M251KG6AE	
		Pin No.	Function
JP6.25	121	V _{REF}	
JP6.26	122	AV _{SS}	
JP6.27	123	PB.11/EADC0_CH11/EBI_ADR16/UART0_nCTS/I2C1_SCL/SPI0_I2SMCLK/BPWM1_CH0	
JP6.28	124	PB.10/EADC0_CH10/EBI_ADR17/USCI1_CTL0/UART0_nRTS/I2C1_SDA/BPWM1_CH1	
JP6.29	125	PB.9/EADC0_CH9/EBI_ADR18/USCI1_CTL1/UART0_TXD/UART1_nCTS/I2C1_SMBAL/BPWM1_CH2	
JP6.30	126	PB.8/EADC0_CH8/EBI_ADR19/USCI1_CLK/UART0_RXD/UART1_nRTS/I2C1_SMBSUS/BPWM1_CH3	
JP6.31	127	PB.7/EADC0_CH7/EBI_nWRL/USCI1_DAT0/UART1_TXD/EBI_nCS0/BPWM1_CH4/PWM1_BRAKE0/PWM1_CH4/INT5/ACMP0_O	
JP6.32	128	PB.6/EADC0_CH6/EBI_nWRH/USCI1_DAT1/UART1_RXD/EBI_nCS1/BPWM1_CH5/PWM1_BRAKE1/PWM1_CH5/INT4/ACMP1_O	

Table 3-2 M251KG6AE Full-pin Extension Connectors and GPIO Function List

3.3.2 Arduino UNO Compatible Extension Connectors

Figure 3-4 shows the Arduino UNO compatible extension connectors.

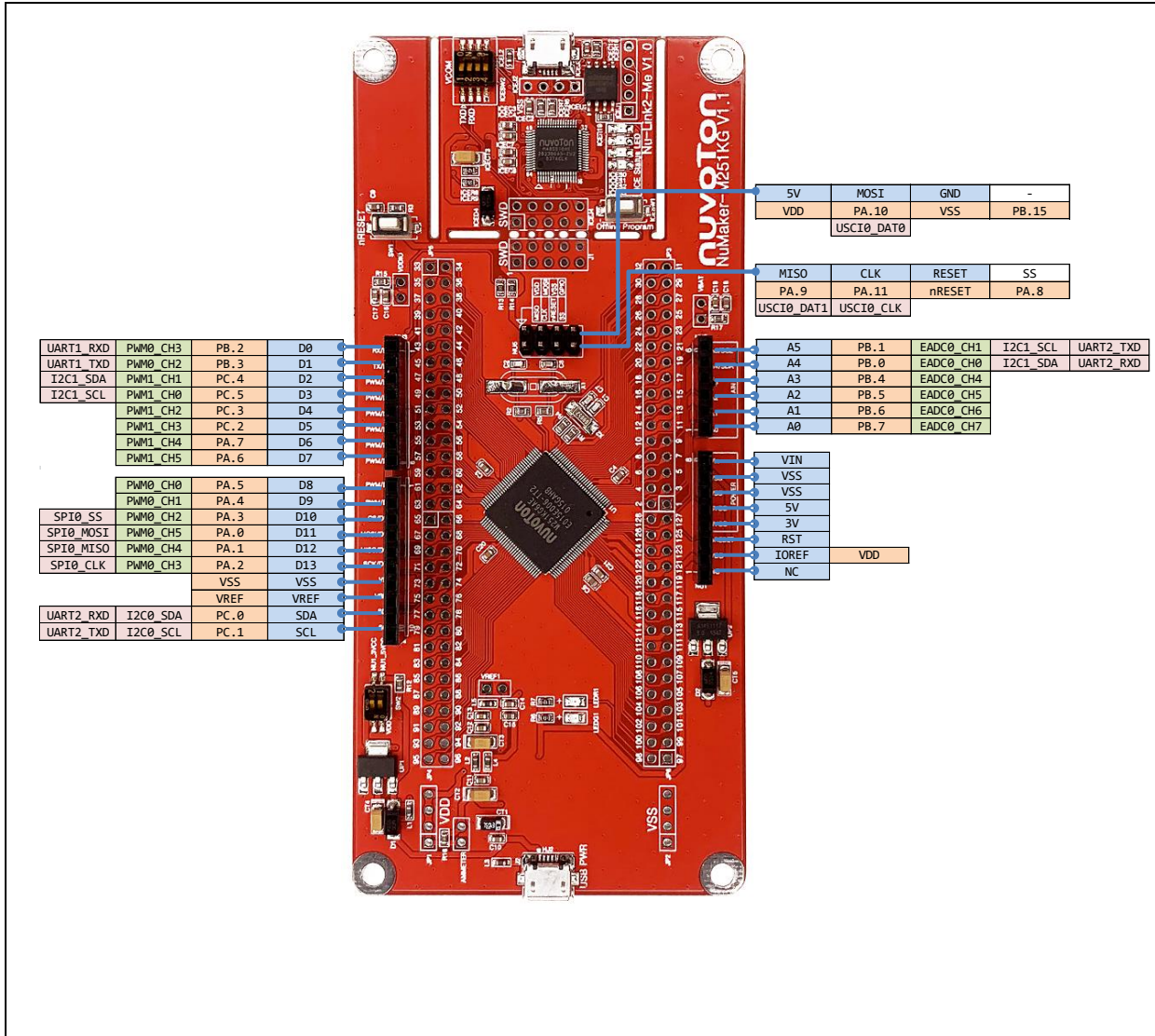

Figure 3-4 Arduino UNO Compatible Extension Connectors

Header		NuMaker-M251KG		Header		NuMaker-M251KG	
		Compatible to Arduino UNO	GPIO Pin of M251			Compatible to Arduino UNO	GPIO Pin of M251
N U 4	NU3.1	D0	PB.2	N U 2	NU2.6	A5	PB.1
	NU3.2	D1	PB.3		NU2.5	A4	PB.0
	NU3.3	D2	PC.4		NU2.4	A3	PB.4
	NU3.4	D3	PC.5		NU2.3	A2	PB.5
	NU3.5	D4	PC.3		NU2.2	A1	PB.6
	NU3.6	D5	PC.2		NU2.1	A0	PB.7
	NU3.7	D6	PA.7	N U 1	NU1.8	VIN	-
	NU3.8	D7	PA.6		NU1.7	VSS	
N U 3	NU4.1	D8	PA.5		NU1.6	VSS	
	NU4.2	D9	PA.4		NU1.5	5V	
	NU4.3	D10	PA.3		NU1.4	3V	
	NU4.4	D11	PA.0		NU1.3	RST	nRESET
	NU4.5	D12	PA.1		NU1.2	IOREF	V _{DD}
	NU4.6	D13	PA.2	NU1.1	NC	-	
	NU4.7	VSS	V _{SS}				
	NU4.8	VREF	V _{REF}				
	NU4.9	SDA	PC.0				
	NU4.10	SCL	PC.1				

Table 3-3 Arduino UNO Extension Connectors and M251KG6AE Mapping GPIO List

3.4 Power Supply Configuration

The NuMaker-M251KG is able to adopt multiple power supply. External power source includes NU1 Vin (7 V to 12 V), VDD (depends on target chip operating voltage), and PC through USB connector. By using switches and voltage regulator, multiple power domains can be created on the NuMaker-M251KG.

3.4.1 VIN Power Source

Table 3-4 presents the Vin power source.

Connector	Net Name in Schematic	Comment
NU1 pin8	NU1_VIN	Board external power source, with voltage range from 7 V to 12 V. The voltage regulator UP2 converts the NU1 pin8 input voltage to 5 V and supplies it to NuMaker-M251KG.

Table 3-4 Vin Power Source

3.4.2 5 V Power Sources

Table 3-5 presents the 5 V power sources.

Connector	Net Name in Schematic	Comment
ICEJ3	USB_HS_VBUS	ICE USB connector supplies 5 V power from PC to M251 platform and Nu-Link2-Me.
J2	USB_VBUS	USB connector on NuMaker-M251KG supplies 5 V power from PC to M251 platform and Nu-Link2-Me.
NU1 pin5	NU1_5VCC	ICEJ3, J2 or NU1 pin8 supplies 5 V power to NU1 pin5. NU1 pin5 supplies 5 V power to target chip or Arduino adapter board.

Table 3-5 5V Power Sources

3.4.3 3.3 V Power Sources

Table 3-6 presents the 3.3 V power sources.

Voltage Regulator	5V Source	Comment
ICEUP1	USB_HS_VBUS	ICEUP1 converts USB_HS_VBUS to 3.3 V and supplies 3.3V to M251 platform or ICE chip.
UP1	USB_VBUS	UP1 converts USB_VBUS to 3.3 V and supplies 3.3 V to M251 platform. Note: SW2.2(NU1 3VCC) should be switched to ON.
UP1	NU1_5VCC	UP1 converts NU1_5VCC to 3.3 V and supplies 3.3 V to M251 platform. Note: SW2.2(NU1 3VCC) should be switched to ON.

Table 3-6 3.3 V Power Sources

3.4.4 1.8V Power Sources

Table 3-7 presents the 1.8 V power source.

Voltage Regular	5V Source	Comment
ICEUP2	USB_HS_VBUS	ICEUP2 converts USB_HS_VBUS to 1.8V and supplies 1.8V to M251 platform or ICE chip.

Table 3-7 1.8V Power Sources

3.4.5 Power Connectors

Table 3-8 presents the power connectors.

Connector	Comment
JP1	V _{DD} connector on the NuMaker-M251KG
JP2	V _{SS} connector on the NuMaker-M251KG.

Table 3-8 Power Connectors

3.4.6 USB Connectors

Table 3-9 presents the USB connectors.

Connector	Comment
ICEJ3	ICE USB connector on Nu-Link2-Me for power supply, debugging and programming from PC.
J2	USB PWR connector on NuMaker-M251KG for power supply.

Table 3-9 USB Connectors

3.4.7 Power Switches

Table 3-10 presents the power switches.

Switch	Comment
ICEJPR1	Configures the target chip operating voltage at 1.8 V / 3.3 V / 5 V.
ICEJPR2	Configures the ICE chip operating voltage at 1.8 V / 3.3 V.
SW2	Configures the target chip operating voltage at 3.3 V / 5 V.

Table 3-10 Power Switches

3.4.8 Power Supply Models

3.4.8.1 External Power Supply through Nu-Link2-Me to Target Chip

The external power supply source on Nu-Link2-Me is shown in Figure 3-5.

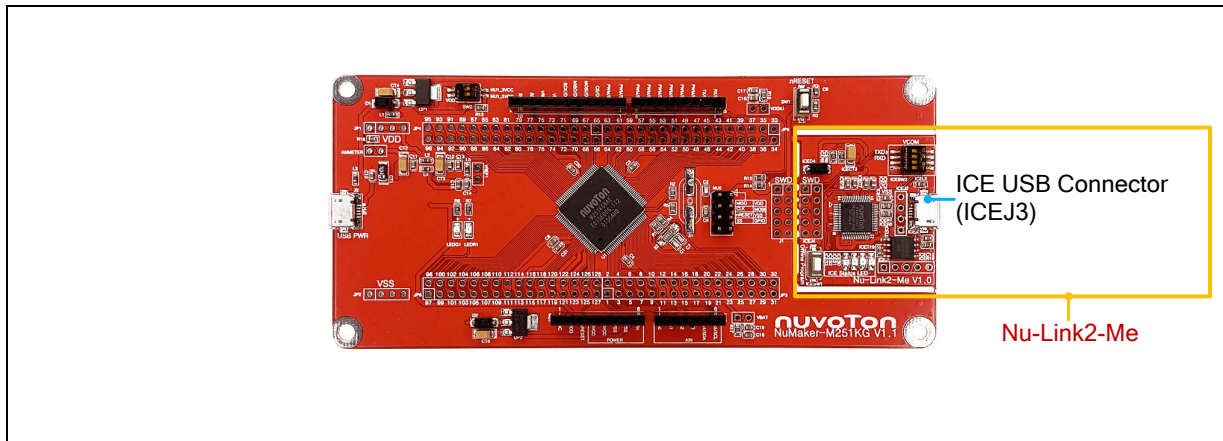

Figure 3-5 External Power Supply Sources on Nu-Link2-Me

To use ICEJ3 as external power supply source with Nu-Link2-Me, please follow the below steps:

1. Solder the resistor on ICEJPR1 (MCUVCC) depends on the target chip operating voltage.
2. Solder the resistor on ICEJPR2 (ICEVCC) depends on the ICE chip operating voltage.
3. Switch the SW2 to OFF.
4. Connect the external power supply to JP1.

Table 3-11 presents all power models when supplies external power through Nu-Link2-Me. The Nu-Link2-Me external power sources are highlighted in yellow.

Model	Target Chip Voltage	ICEJ3	ICEJPR1 (MCUVCC) Selection ^[1]	ICEJPR2 (ICEVCC) Selection ^[2]	ICE Chip Voltage	SW2 Selection	J2	Vin	JP1
1	1.8 V	Connect to PC	1.8 V	1.8 V	1.8 V	Off	X	X	1.8 V output
2	3.3 V	Connect to PC	3.3 V (default)	3.3 V (default)	3.3 V	Off	X	X	3.3 V output
X: Unused. Note: <ol style="list-style-type: none"> 1. 0 Ω should be soldered between ICEJPR1's MCVCC and 1.8 V / 3.3 V / 5 V. 2. 0 Ω should be soldered between ICEJPR2's ICEVCC and 1.8 V / 3.3 V. 3. X: Unused. 									

Table 3-11 Supply External Power through Nu-Link2-Me

3.4.8.2 External Power Supply through M251 platform to Target Chip

The external power supply sources on M251 platform are shown in Figure 3-6.

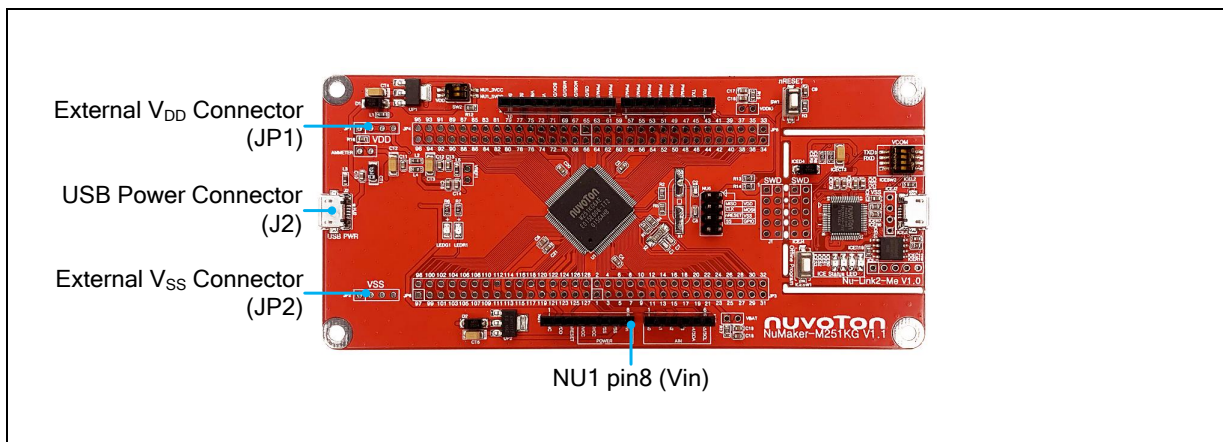

Figure 3-6 External Power Supply Sources on M251 platform

To use Vin or J2 as external power supply source, please follow the below steps:

1. Switch the SW2 depends on the target chip operating voltage.
2. Remove the resistor on ICEJPR1 (MCUVCC).
3. Solder the resistor on ICEJPR2 (ICEVCC) depends on the ICE chip operating voltage.
4. Connect the external power supply to Vin or J2.

To use JP1 as external power supply source, please follow the below steps:

1. Switch the SW2 to OFF.
2. Remove the resistor on ICEJPR1 (MCUVCC).
3. Solder the resistor on ICEJPR2 (ICEVCC) depends on the ICE chip operating voltage.
4. Connect ICEJ3 to PC.
5. Connect the external power supply to JP1.

To use Vin or J2 as external power supply source with Nu-Link2-Me separated from NuMaker-M251KG, please follow the below steps:

1. Switch the SW2 depends on the target chip operating voltage.
2. Separate the Nu-Link2-Me from NuMaker-M251KG.
3. Connect the external power supply to Vin or J2.

To use JP1 as external power supply source with Nu-Link2-Me separated from NuMaker-M251KG, please follow the below steps:

1. Switch the SW2 to OFF.
2. Separate the Nu-Link2-Me from NuMaker-M251KG.
3. Connect the external power supply to JP1.

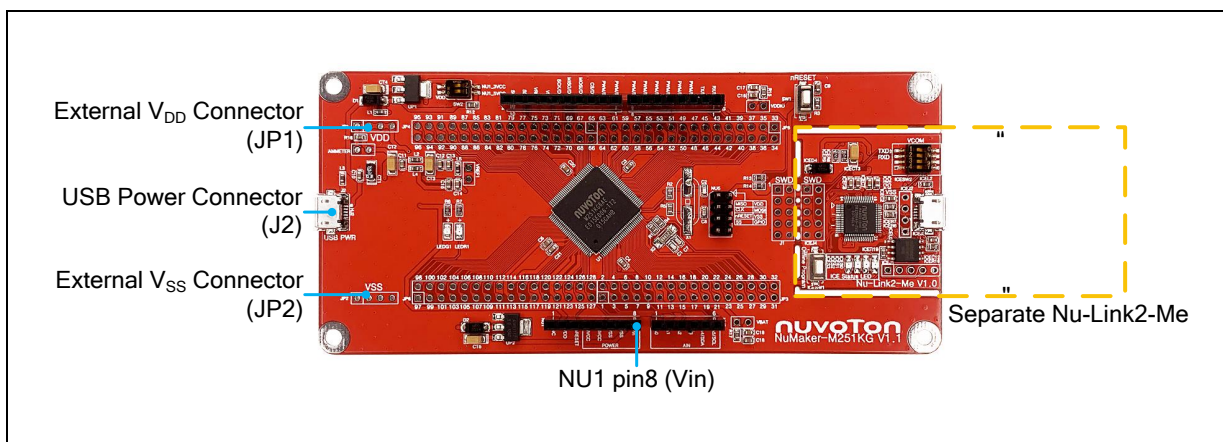

Figure 3-7 Separate the Nu-Link2-Me from NuMaker-M251KG

Table 3-12 presents all power models when supplies external power through M251 platform. The M251 platform external power sources are highlighted in yellow.

Model	Target Chip Voltage	Vin ^[1]	J2	ICEJ3	SW2 Selection	JP1 ^[2]	ICEJPR1 (MCUVCC) Selection ^[3]	ICEJPR2 (ICEVCC) Selection ^[4]	ICE Chip Voltage ^[5]
3	3.3 V	7 V ~ 12 V Input	X	X	NU1 3VCC	3.3 V output	Remove resistor	3.3 V	3.3 V
4	3.3 V	X	Connect to PC	X	NU1 3VCC	3.3 V output	Remove resistor	3.3 V	3.3 V
5	1.8 V ~ 3.6 V	X	X	Connect to PC	OFF	DC Input 1.8 V ~ 3.6 V	Remove resistor	1.8 V / 3.3 V	1.8 V / 3.3 V
6	1.8 V ~ 3.6 V	X	X	Nu-Link2-Me removed	OFF	DC Input 1.8 V ~ 3.6 V	X	X	X

X: Unused.

Note:

- The Vin input voltage will be converted by voltage regulator UP2 to 5 V. Supply external power to Vin or J2 can provide 5 V to NU1 pin5 (5V) and 3.3 V to NU1 pin4 (3VCC).
- JP1 external power input only provides voltage to target chip.
- 0Ω should be removed from ICEJPR1's MCVCC and 1.8 V / 3.3 V / 5 V.
- 0Ω should be soldered between ICEJPR2's ICEVCC and 1.8 V / 3.3 V.
- The ICE chip voltage should be close to the target chip voltage.
- X: Unused

Table 3-12 Supply External Power for M251 platform

3.5 External Reference Voltage Connector

Table 3-13 presents the external reference voltage connector.

Connector	Comment
VREF1	Connector for user to easily connect to the external reference voltage pin of the target chip. User needs to remove the L5 ferrite bead.

Table 3-13 External Reference Voltage Connector

3.6 Voltage Adjustable Interface(VAI) Connector

Table 3-14 presents the voltage adjustable interface connector.

Connector	Comment
VDDIO	Connector for user to easily connect to the V _{DDIO} pin of the target chip as power source of PA.0 ~ PA.5. User needs to remove the R15 resistor.

Table 3-14 Voltage Adjustable Interface Connector

3.7 Battery Voltage (V_{BAT}) Connector

Table 3-14 presents the battery voltage interface connector.

Connector	Comment
VBAT	Connector for user to easily connect to the V _{BAT} pin of the target chip as power source of PF.4 ~ PF.6, RTC and LXT. User needs to remove the R17 resistor.

Table 3-15 Battery Voltage Interface Connector

3.8 Ammeter Connector

Table 3-16 presents the ammeter connector.

Connector	Comment
AMMETER	Connector for user to easily measure the target chip power consumption. User needs to remove the R16 resistor.

Table 3-16 Ammeter Connector

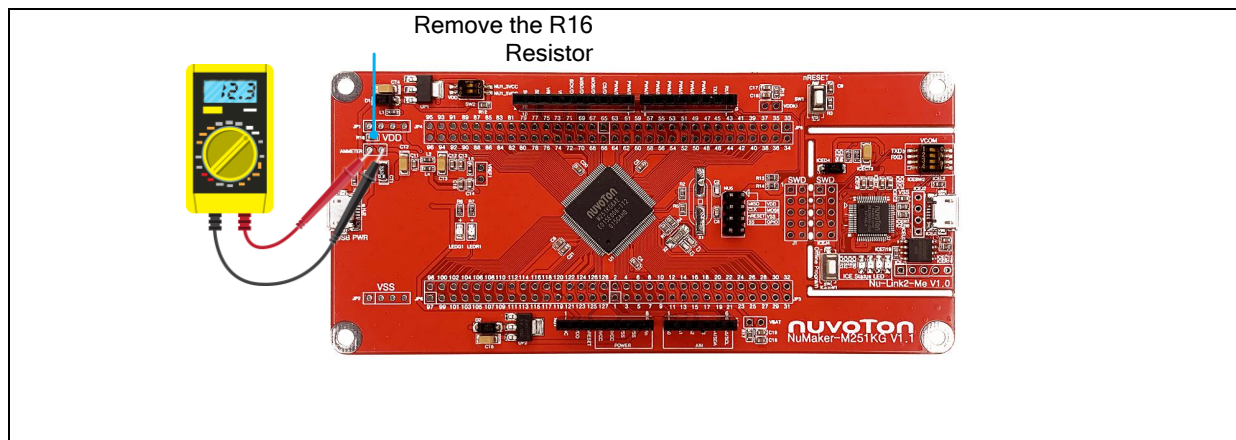

Figure 3-8 Wiring between Ammeter Connector and Ammeter

3.9 Push-Buttons

Table 3-17 presents the push-buttons.

Component	Comment
ICESW1	Off-line program button to start off-line programming the target chip.
SW1	Reset button to reset the target chip.

Table 3-17 Push-Buttons

3.10 LEDs

Table 3-18 presents the LEDs.

Component	Comment
Power LED	The power LED indicates that the NuMaker-M251KG is powered.
PB14 LED	The LED is connected to the target chip PB.14.
ICES0, ICES1, ICES2 and ICES3	Nu-Link2-Me status LED.

Table 3-18 LEDs

3.11 Nu-Link2-Me

The Nu-Link2-Me is an attached on-board debugger and programmer. The Nu-Link2-Me supports on-chip debugging, online and offline ICP programming through SWD interface. The Nu-Link2-Me also supports virtual COM port (VCOM) for printing debug messages on PC. Besides, the programming status could be shown on the built-in LEDs. Lastly, the Nu-Link2-Me could be detached from the development board and becoming a stand-alone mass production programmer. For more information about Nu-Link2-Me, please refer to Nu-Link2-Pro Debugger and Programmer User Manual.

3.11.1 VCOM Switches

Table 3-19 presents how to set the VCOM function by ICESW2.

ICESW2		
Pin	Function	Description
1	TXD	On: Connect target chip PB.13 (UART0_TXD) to Nu-Link2-Me. Off: Disconnect target chip PB.13 (UART0_TXD) to Nu-Link2-Me.
2	RXD	On: Connect target chip PB.12 (UART0_RXD) to Nu-Link2-Me. Off: Disconnect target chip PB.12 (UART0_RXD) to Nu-Link2-Me.
Note: Pin 3 and 4 is unused.		

Table 3-19 VCOM Function of Nu-Link2-Me

3.11.2 Status LEDs

Table 3-20 presents the status LEDs patterns for different operation on Nu-Link2-Me.

Operation Status	Status LED			
	ICES0	ICES1	ICES2	ICES3
Power on	Flash x 3	Flash x 3	Flash x 3	Flash x 3
Connected to IDE/NuTool	Flash x 3	Flash x 3	Flash x 3	On
ICE online (Not connected to a target chip)	On	-	Flash x 3	Flash x 3
ICE online (Connected to a target chip)	On	-	-	On
ICE online (Failed to connect to a target chip)	On	Any	Flash	On
During Offline Programming	-	On	-	Flash
Offline Programming Completed	On	-	-	-
Offline Programming Completed (Auto mode)	On	On	-	-
Offline Programming Failed	On	Flash	-	-

Table 3-20 Operation Status LED Patterns

4 QUICK START

4.1 Toolchains Supporting

Install the preferred toolchain. Please make sure at least one of the toolchains has been installed.

- [KEIL MDK Nuvoton edition M0/M23](#)
- [IAR EWARM](#)
- [NuEclipse GCC \(for Windows\)](#)
- [NuEclipse GCC \(for Linux\)](#)

4.2 Nuvoton Nu-Link Driver Installation

Download and install the latest Nuvoton Nu-Link Driver.

- Download and install [Nu-Link_Keil_Driver](#) when using Keil MDK.
- Download and install [Nu-Link_IAR_Driver](#) when using IAR EWARM.
- Skip this step when using NuEclipse.

Please install the Nu-Link USB Driver as well at the end of the installation. The installation is presented in Figure 4-1 and Figure 4-2.

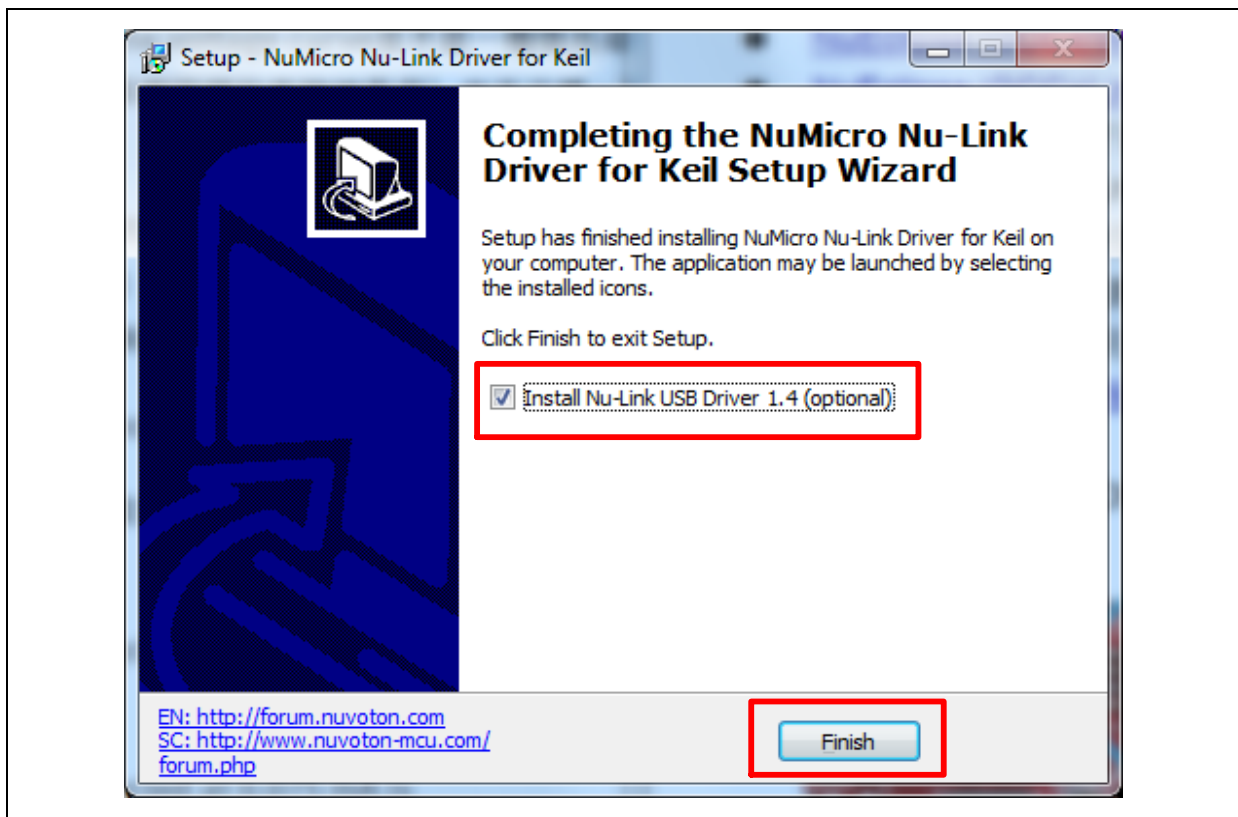

Figure 4-1 Nu-Link USB Driver Installation Setup



Figure 4-2 Nu-Link USB Driver Installation

4.3 BSP Firmware Download

Download and unzip the [Board Support Package \(BSP\)](#).

4.4 Hardware Setup

1. Open the virtual COM (VCOM) function by changing Nu-Link2-Me VCOM Switch No. 1 and 2 to ON.

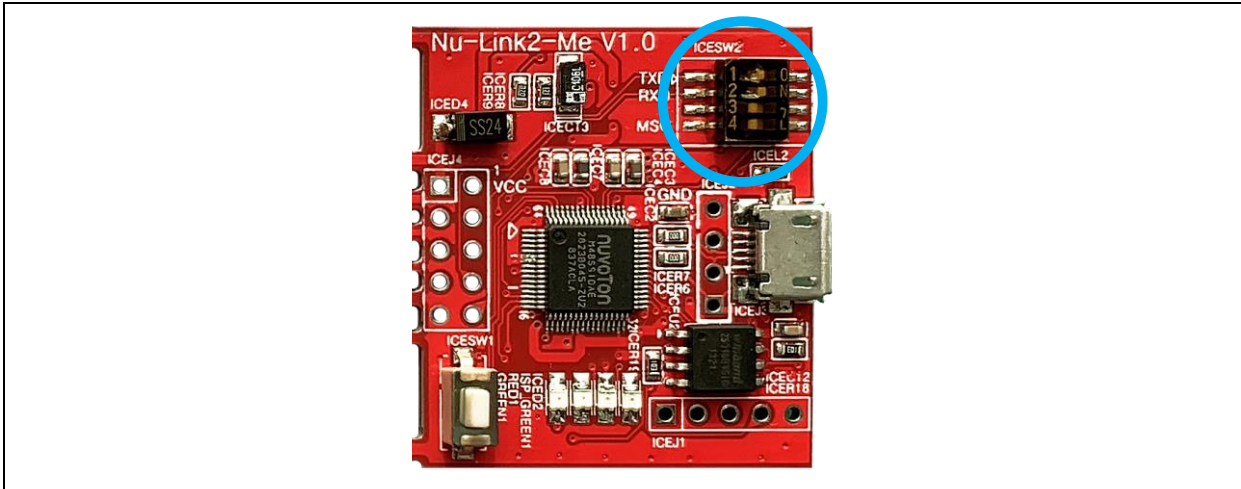

Figure 4-3 Open VCOM Function

2. Connect the ICE USB connector shown in Figure 4-4 to the PC USB port through USB cable.

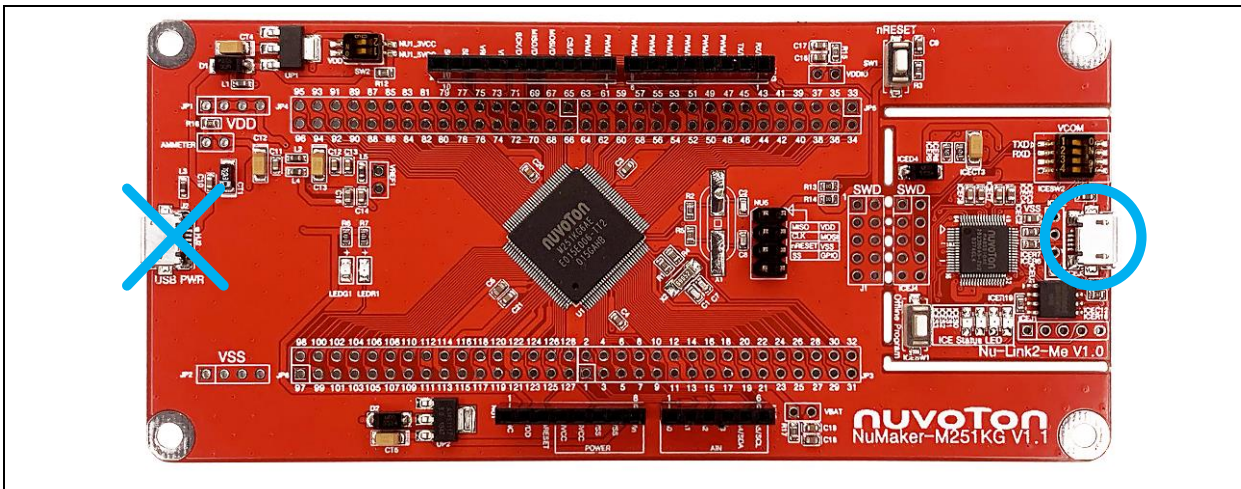

Figure 4-4 ICE USB Connector

3. Find the “Nuvoton Virtual COM Port” on the Device Manger as Figure 4-5.

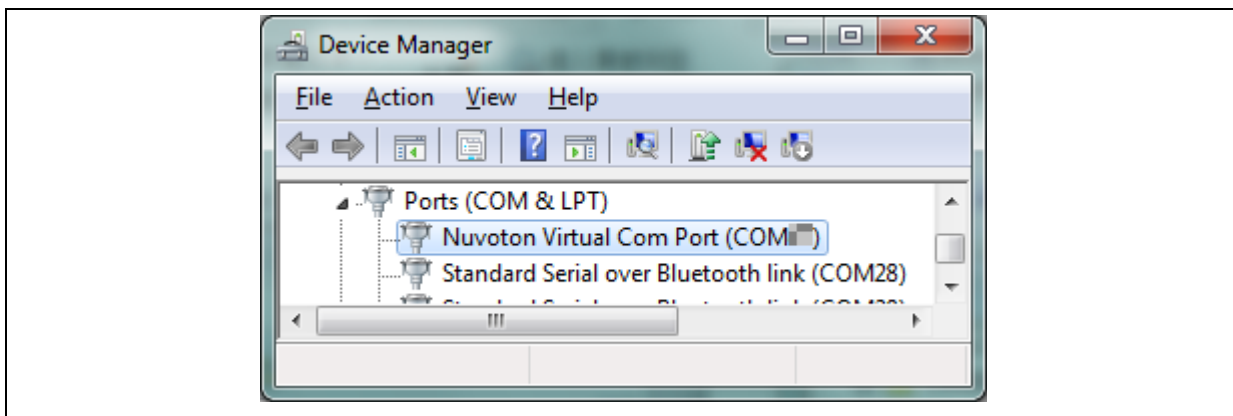

Figure 4-5 Device Manger

- 4. Open a serial port terminal, PuTTY for example, to print out debug message. Set the speed to 115200. Figure 4-6 presents the PuTTY session setting.

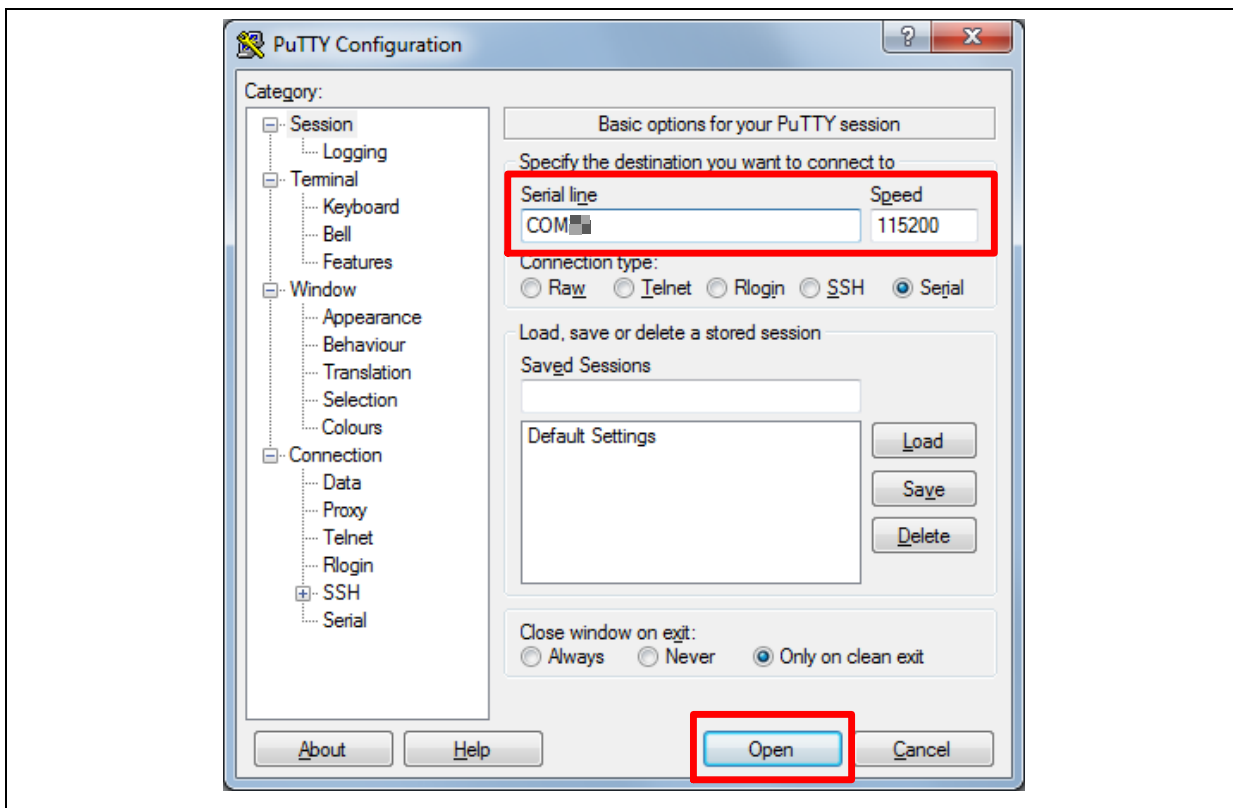

Figure 4-6 PuTTY Session Setting

4.5 Find the Example Project

Use the “Template” project as an example. The project can be found under the BSP folder as shown in Figure 4-7.

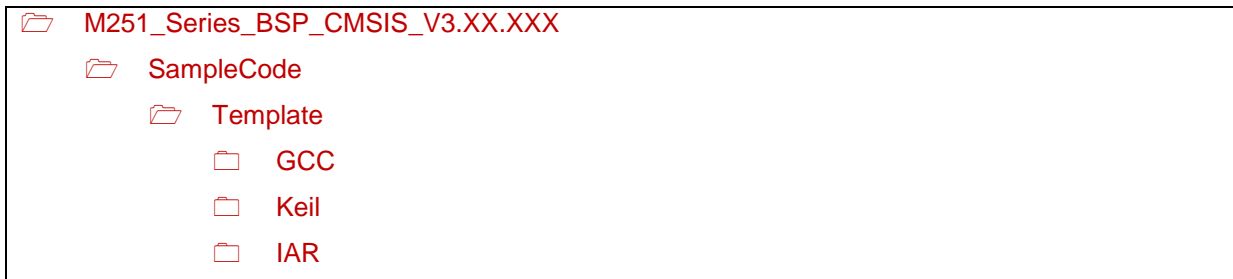

Figure 4-7 Template Project Folder Path

4.6 Execute the Project under Toolchains

Open and execute the project under the toolchain. The section 4.6.1, 0, and 4.6.3 describe the steps of executing project in Keil MDK, IAR EWARM and NuEclipse, respectively.

4.6.1 Keil MDK

This section provides steps to beginners on how to run a project by using Keil MDK.

1. Double click the “Template.uvproj” to open the project.

Note: If Figure 4-8 warning message jumps out, please migrate to version 5 formats as shown in Figure 4-9. The “.uvproj” filename extension will change to “.uvprojx”.

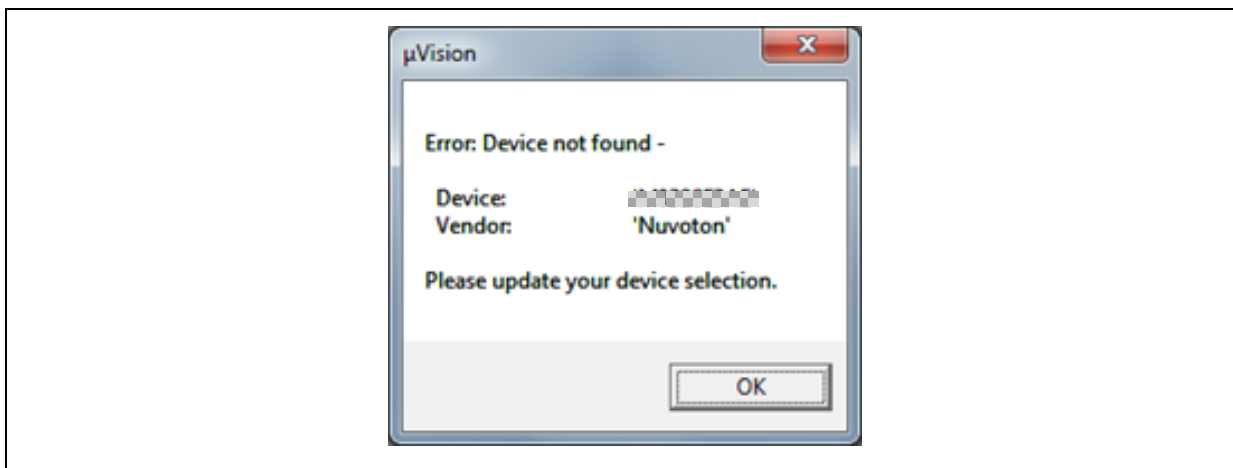

Figure 4-8 Warning Message of “Device not found”

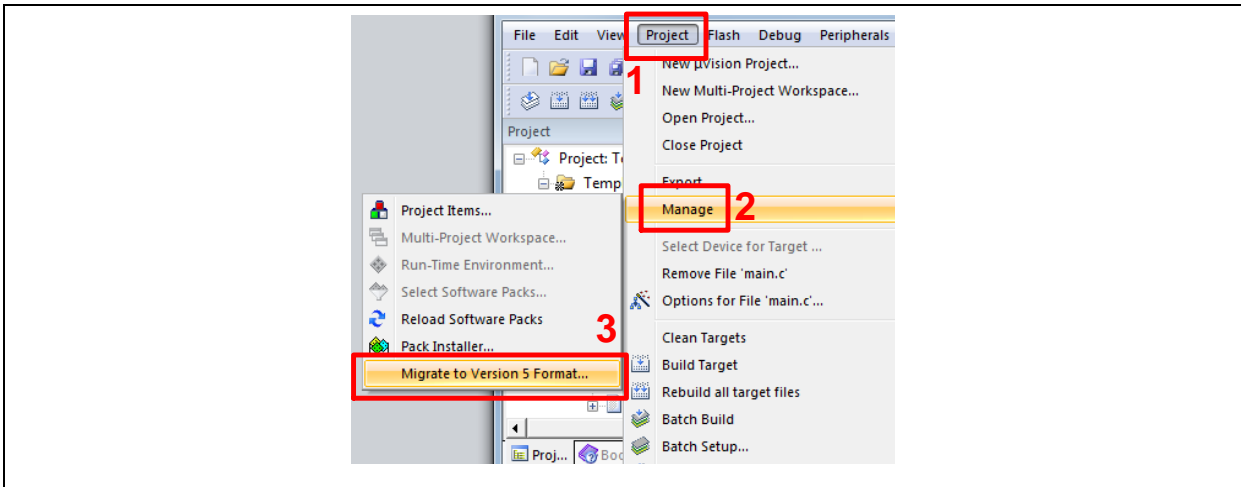

Figure 4-9 Project File Migrate to Version 5 Format

2. Make sure the debugger is “Nuvoton Nu-Link Debugger” as shown in Figure 4-10 and Figure 4-11.

Note: If the dropdown menu in Figure 4-10 does not contain “Nuvoton Nu-Link Debugger” item, please rework section .

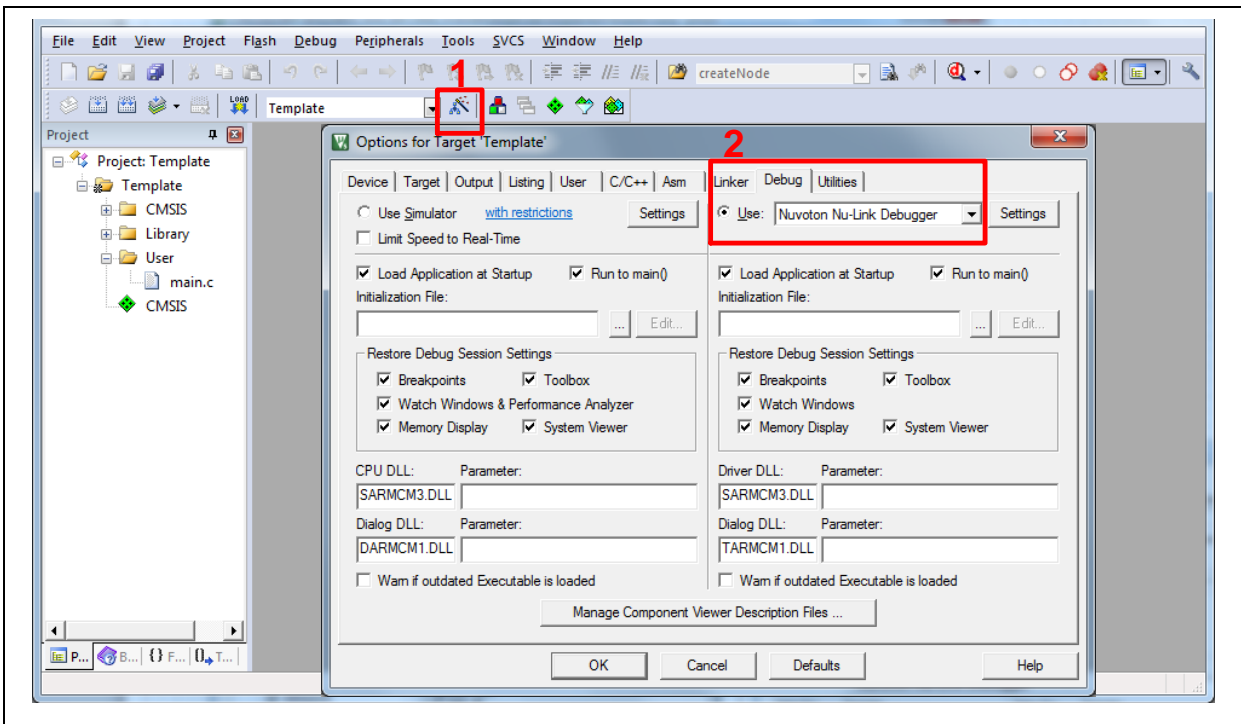

Figure 4-10 Debugger Setting in Options Window

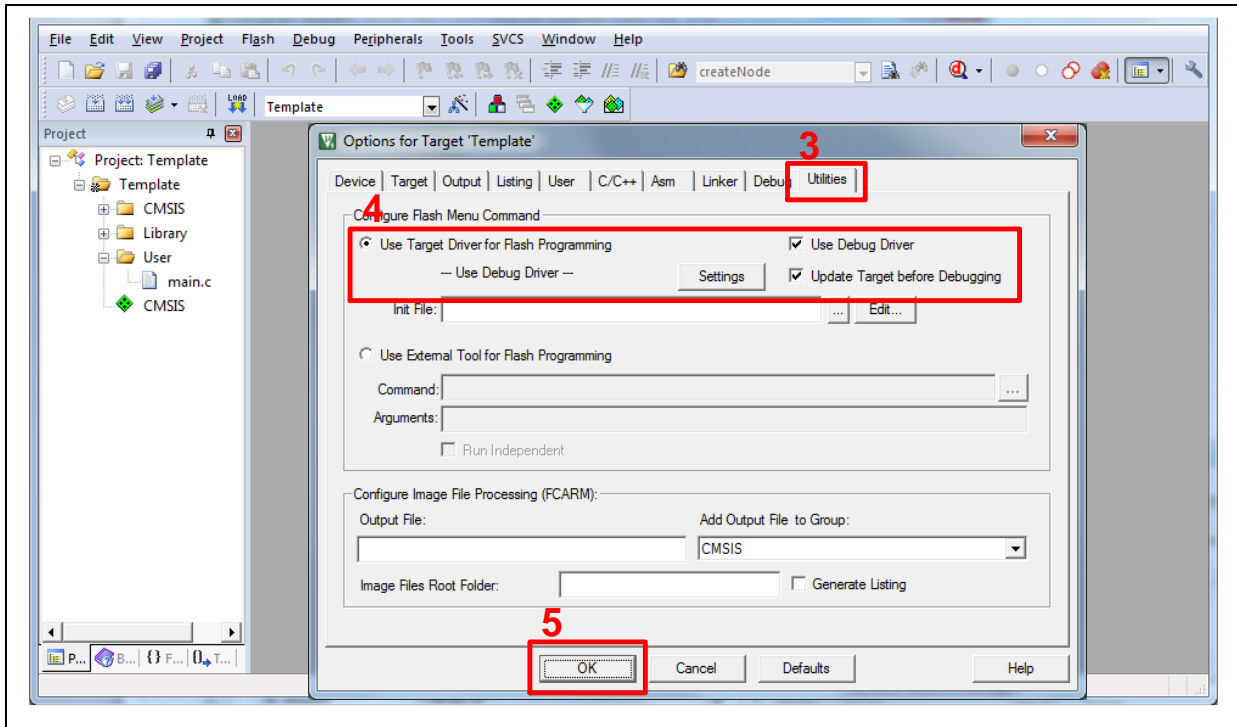

Figure 4-11 Programming Setting in Options Window

3. Rebuild all target files. After successfully compile the project, download code to the flash memory. Click “Start/Stop Debug Section” button can enter debug mode.

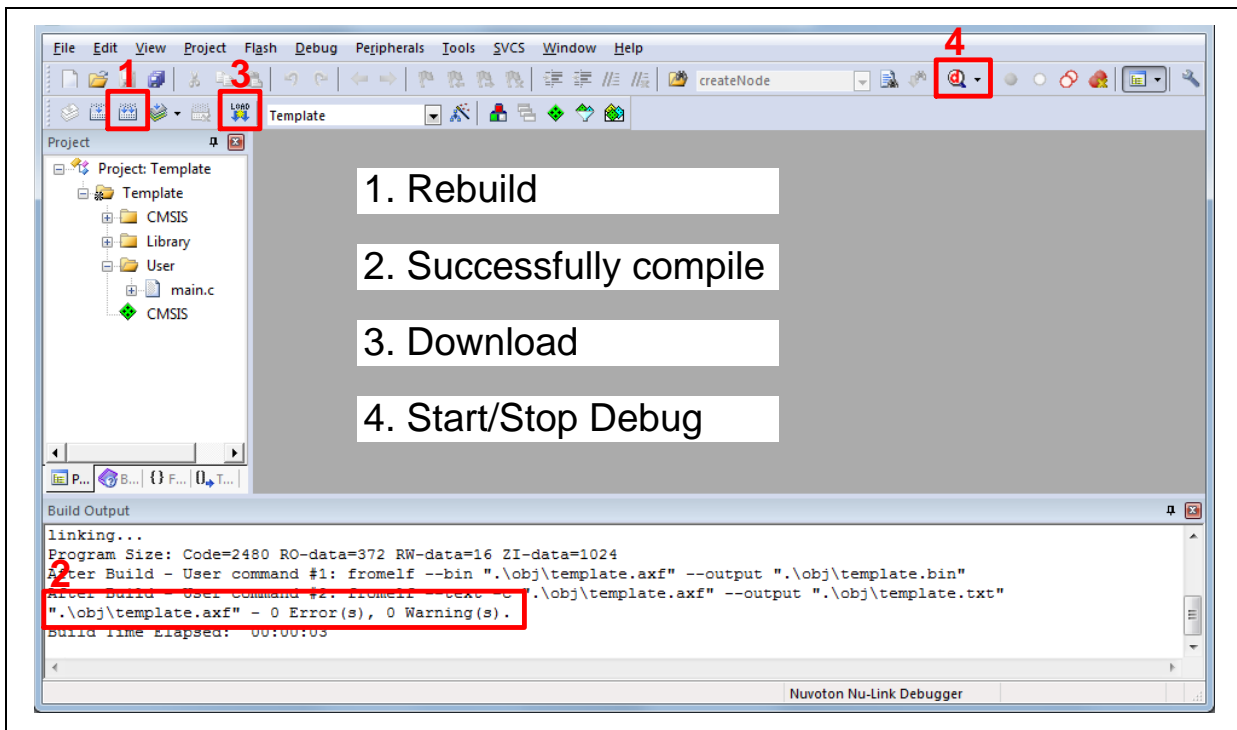

Figure 4-12 Compile and Download the Project

4. Figure 4-13 shows the debug mode under Keil MDK. Click “Run” and the debug message will be printed out as shown in Figure 4-14. User can debug the project under debug mode by checking

source code, assembly language, peripherals' registers, and setting breakpoint, step run, value monitor, etc.

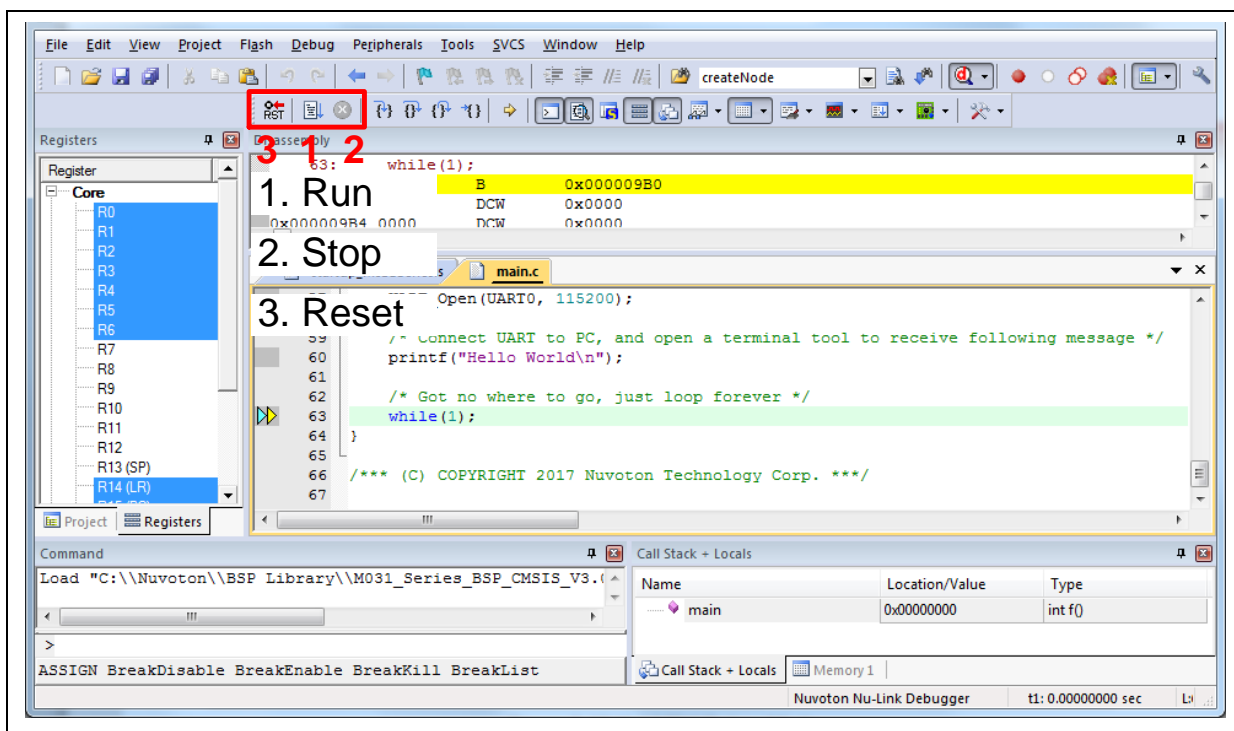

Figure 4-13 Keil MDK Debug Mode



Figure 4-14 Debug Message on Serial Port Terminal Windows

4.6.2 IAR EWARM

This section provides steps to beginners on how to run a project by using IAR EWARM.

1. Double click the “Template.eww” to open the project.
2. Make sure the toolbar contain “Nu-Link” item as shown in Figure 4-15.

Note: If the toolbar does not contain “Nu-Link” item, please rework section .

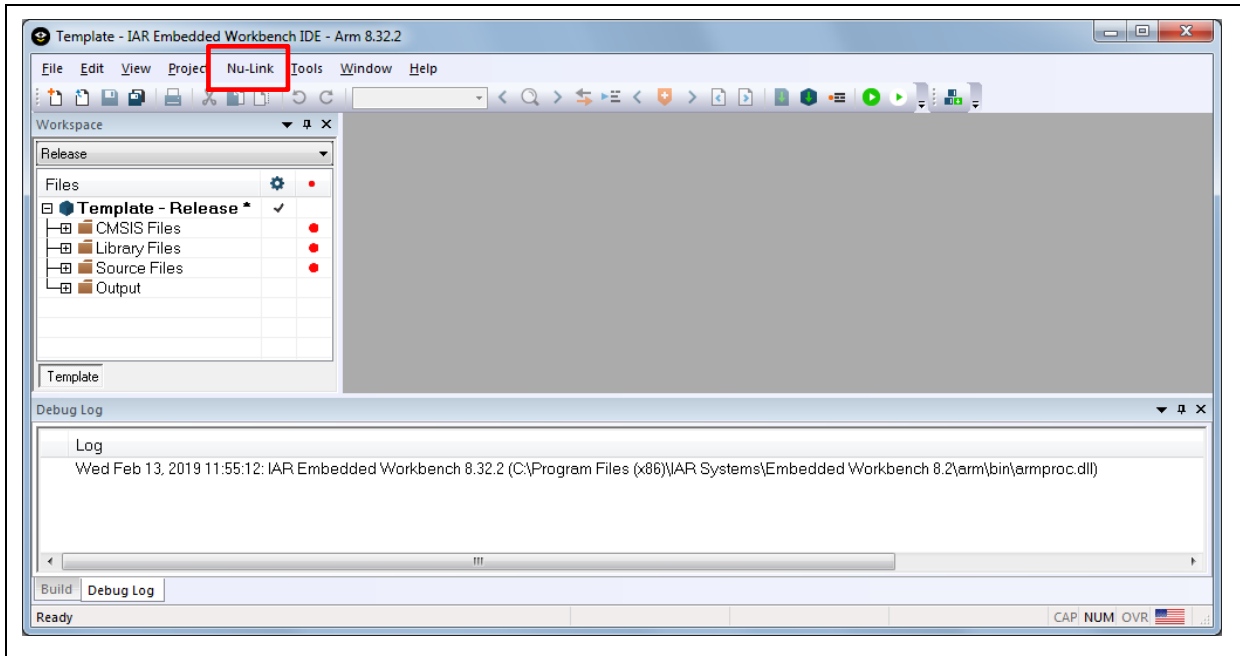

Figure 4-15 IAR EWARM Window

3. Make target file as presented in Figure 4-16. After successfully compile the project, download code to the flash memory and enter debug mode.

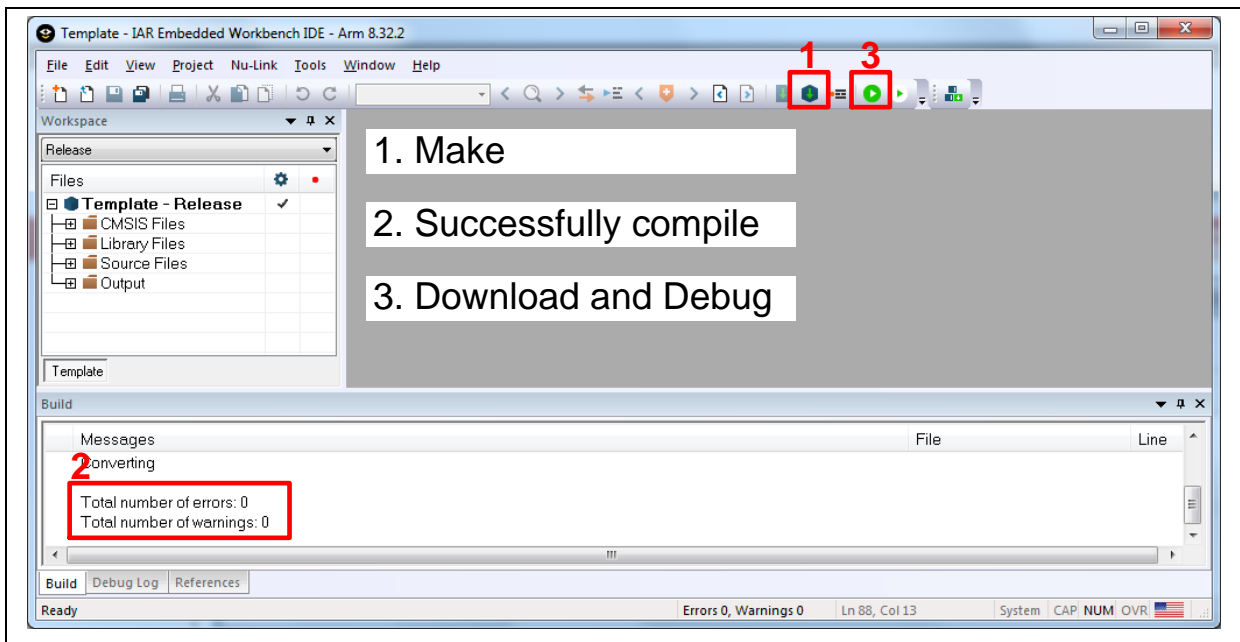

Figure 4-16 Compile and Download the Project

- Figure 4-17 shows the debug mode under IAR EWARN. Click “Go” and the debug message will be printed out as shown in Figure 4-18. User can debug the project under debug mode by checking source code, assembly language, peripherals’ registers, and setting breakpoint, step run, value monitor, etc.

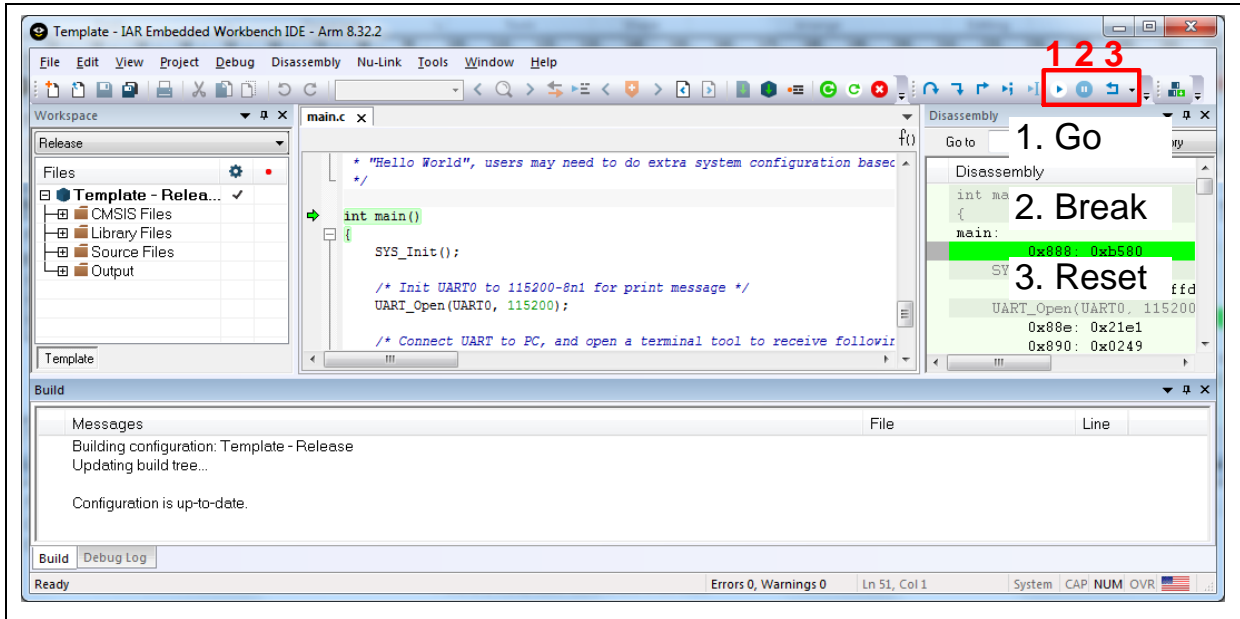

Figure 4-17 IAR EWARM Debug Mode

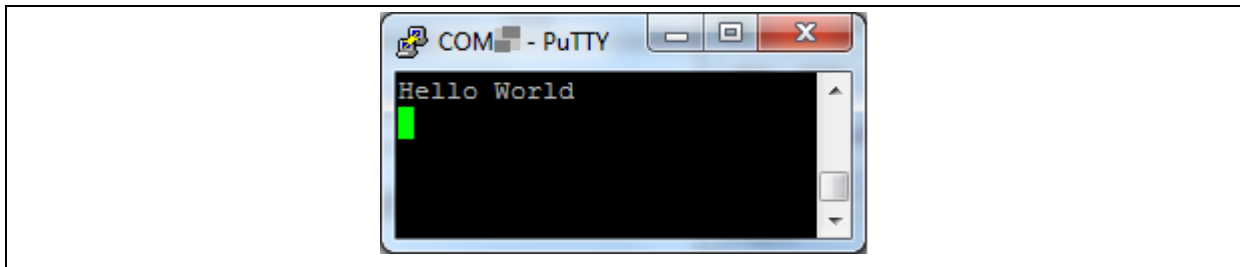

Figure 4-18 Debug Message on Serial Port Terminal Windows

4.6.3 NuEclipse

This section provides steps to beginners on how to run a project by using NuEclipse. Please make sure the filenames and project folder path contain neither invalid character nor space.

- Double-click NuEclipse.exe to open the toolchain.
- Import the “Template” project by following the steps presented in Figure 4-19 and Figure 4-20.

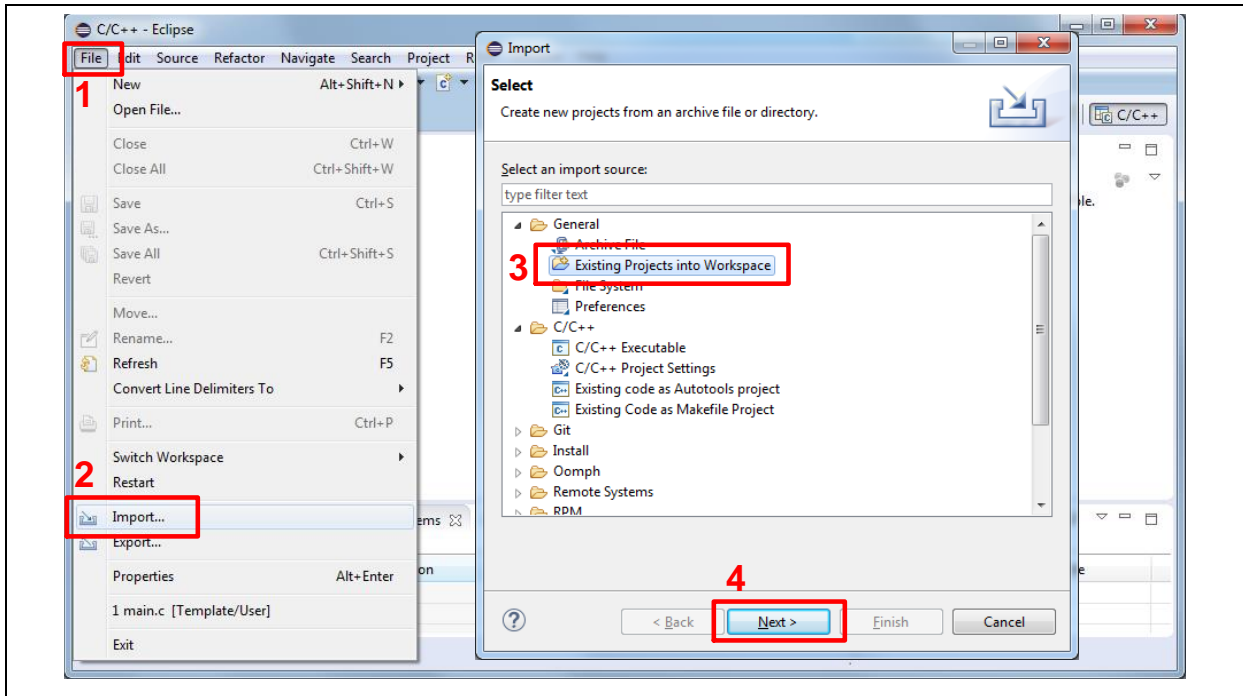

Figure 4-19 Import the Project in NuEclipse

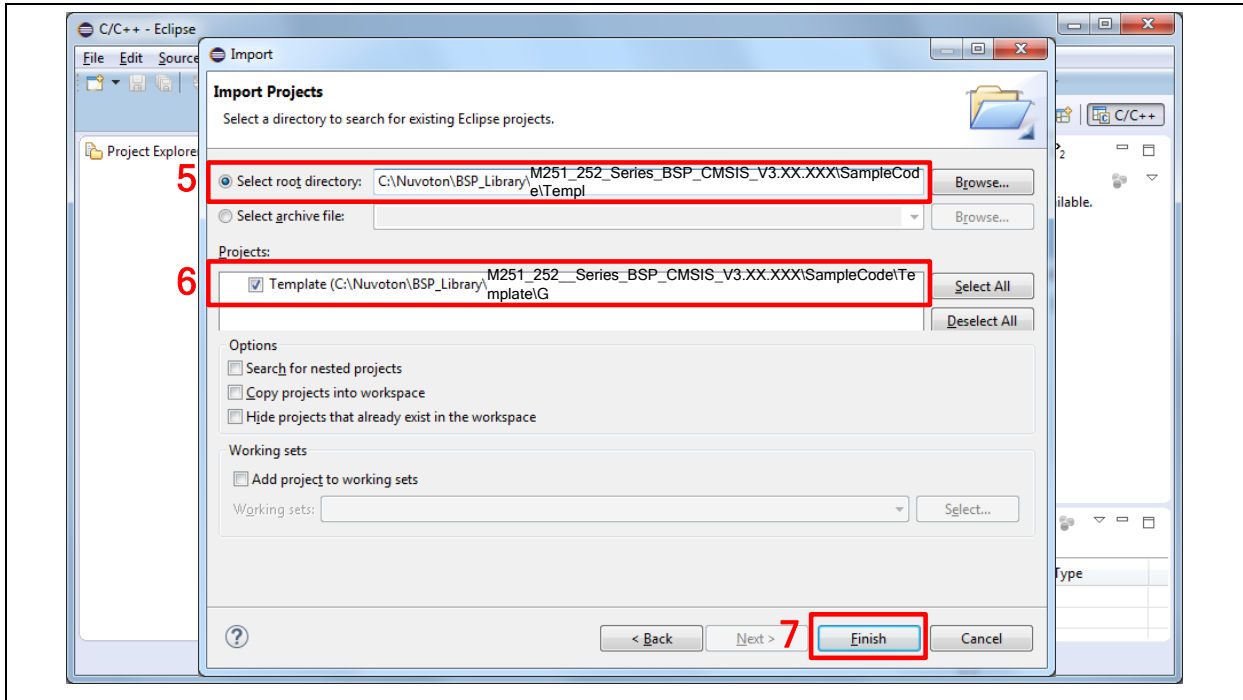

Figure 4-20 Import Projects Windows

3. Click the “Template” project and find the project properties as shown in Figure 4-21. Make sure the settings are the same as settings in Figure 4-22.

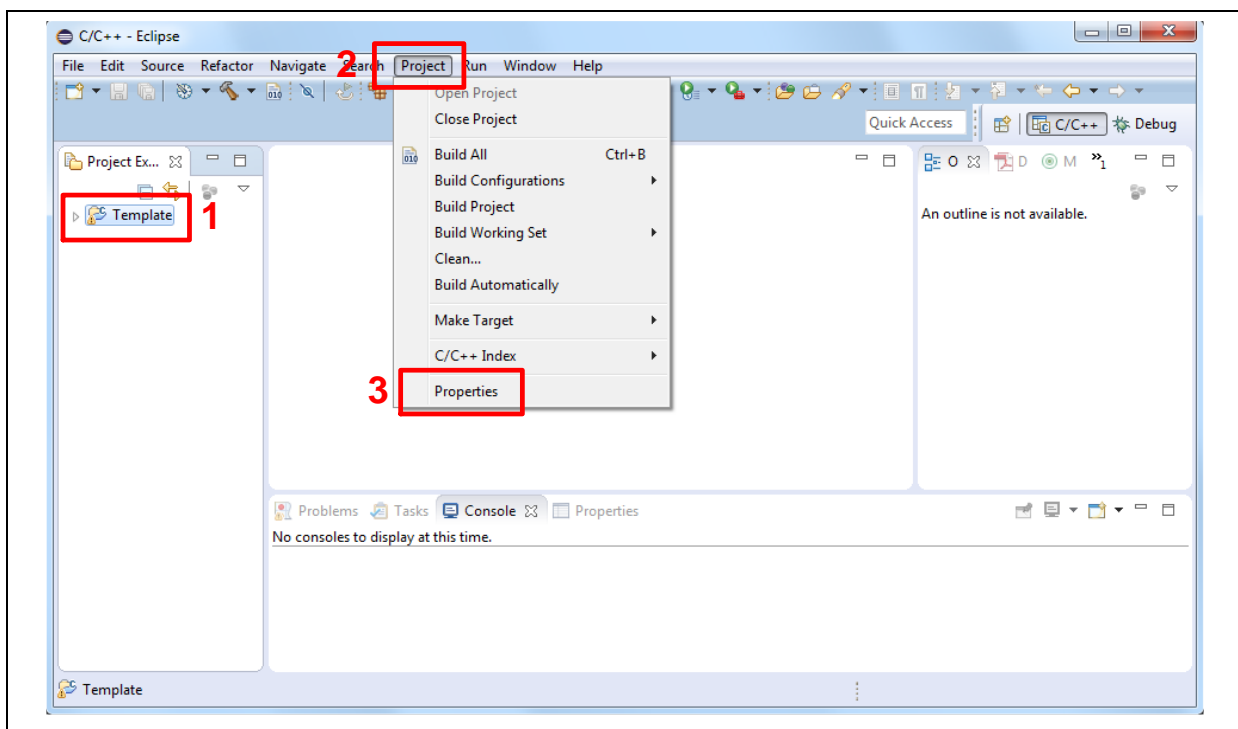

Figure 4-21 Open Project Properties Window

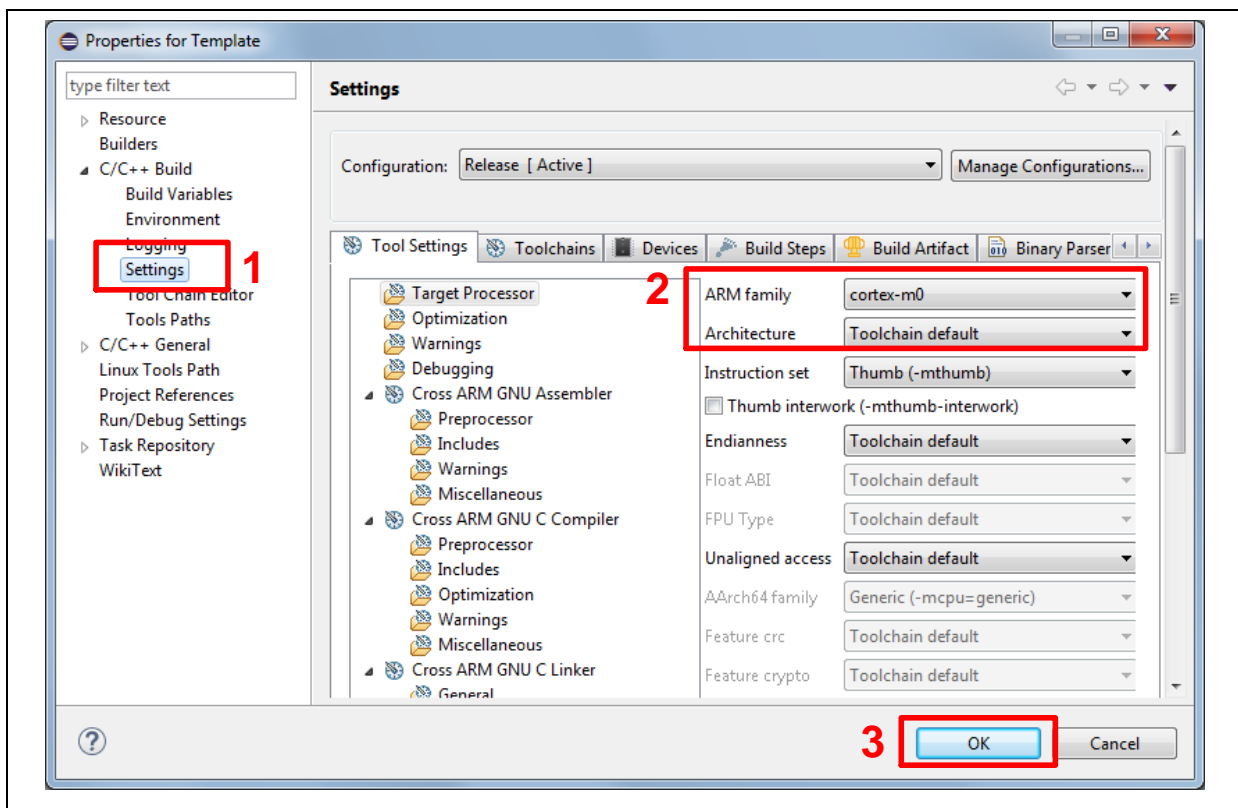

Figure 4-22 Project Properties Settings

4. Click the “Template” project and build the project.

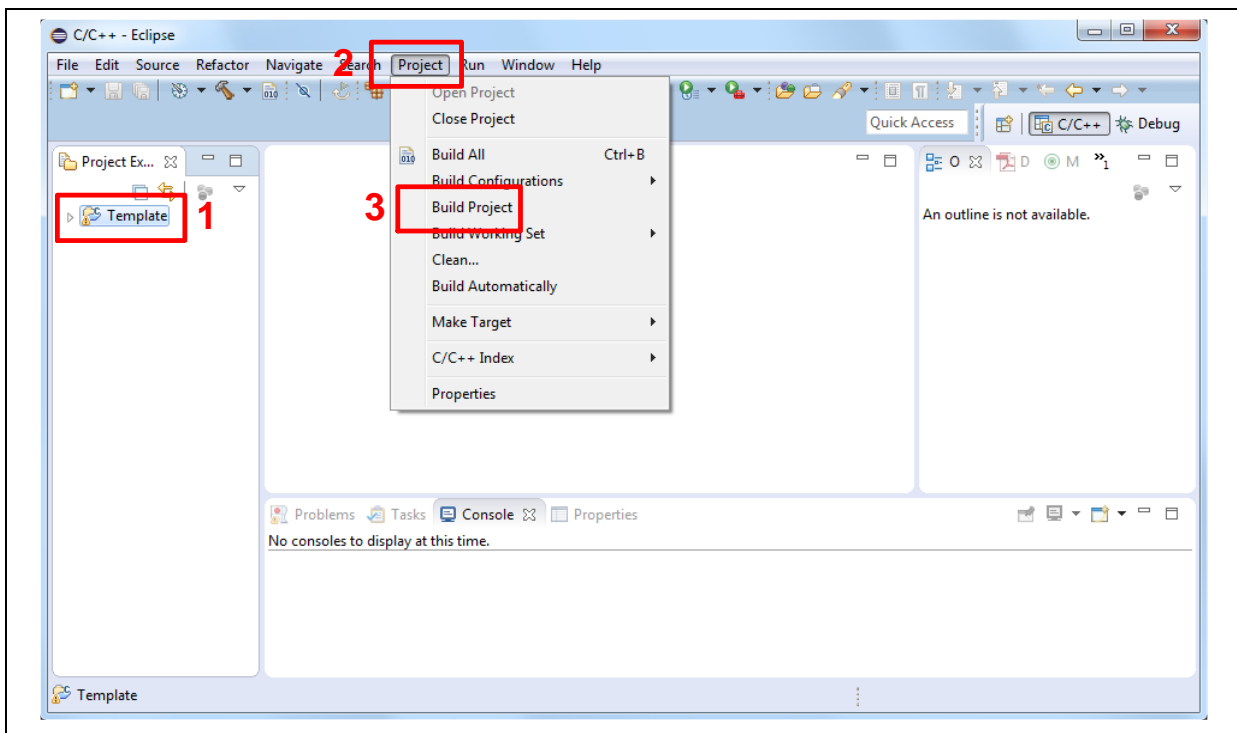

Figure 4-23 Build Project

5. After the project is built, click the “Template” project and set the “Debug Configuration” as shown in Figure 4-24. Follow the settings presented in Figure 4-25, Figure 4-26 and Figure 4-27 to enter debug mode.

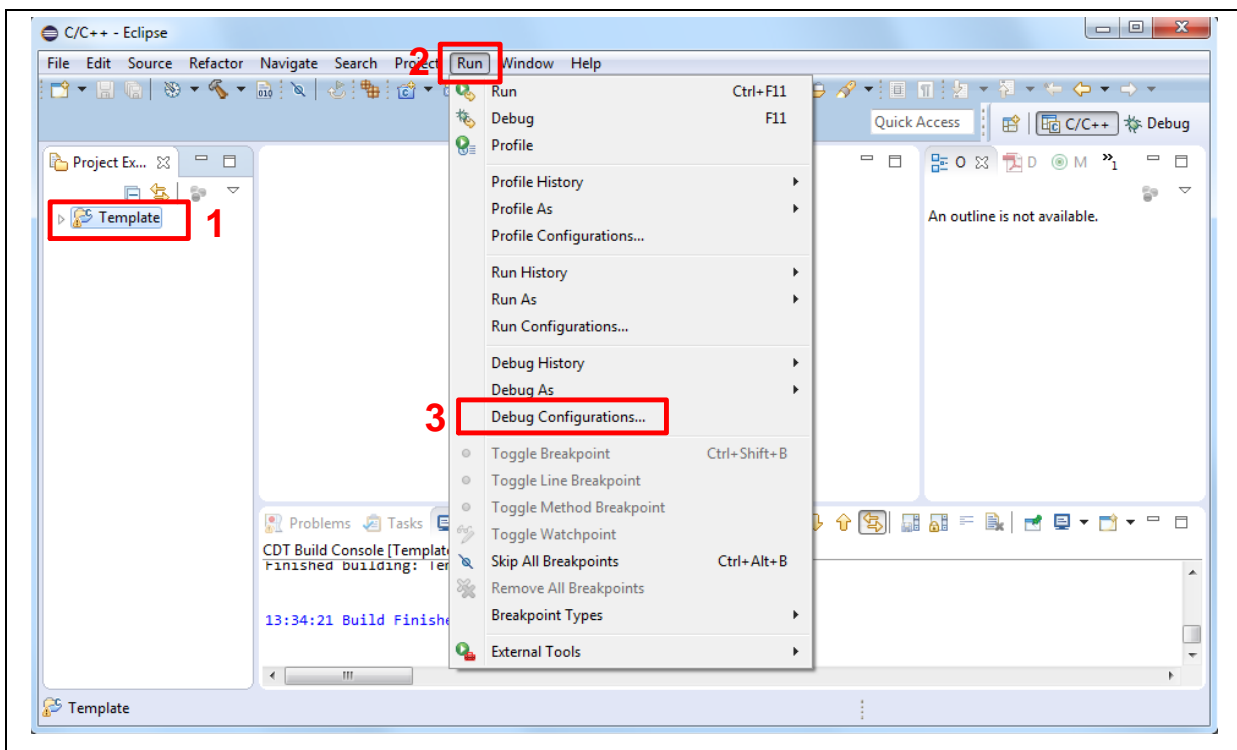
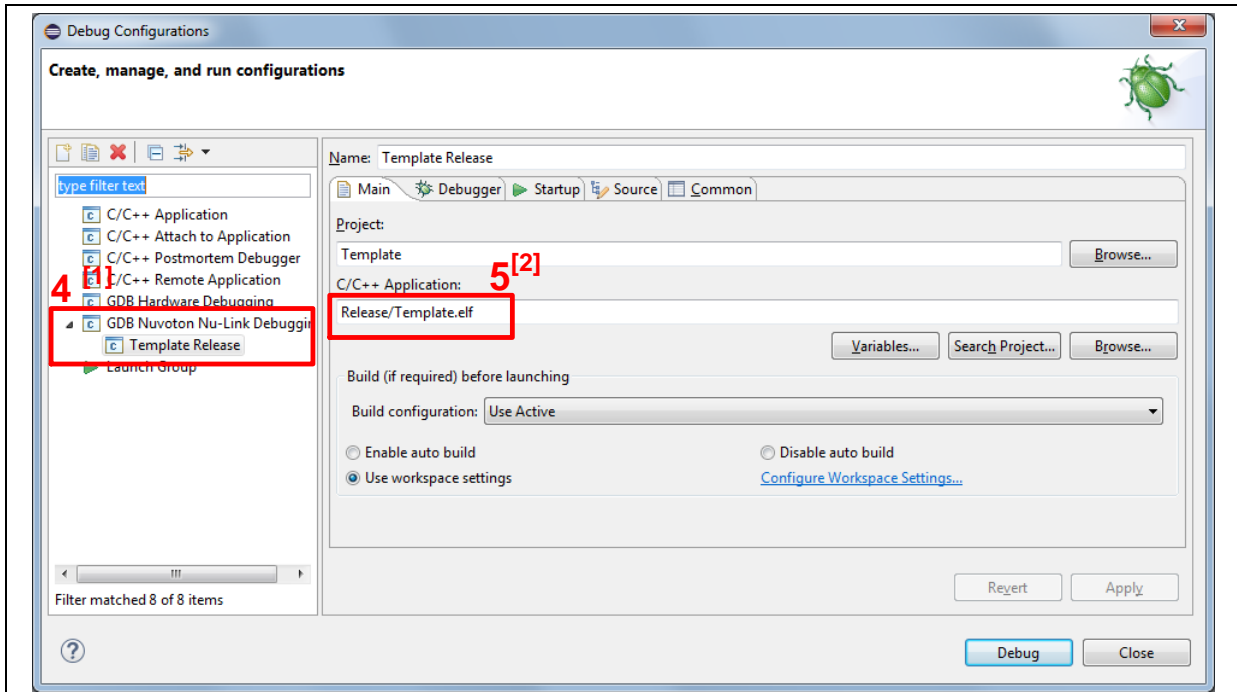

Figure 4-24 Open Debug Configuration



Note 1: Double click the “GDB Nuvoton Nu-Link Debugging” to create the subitem.

Note 2: After the project is built, the “*.elf” file will be shown in “C/C++ Application” frame.

Figure 4-25 Main Tab Configuration

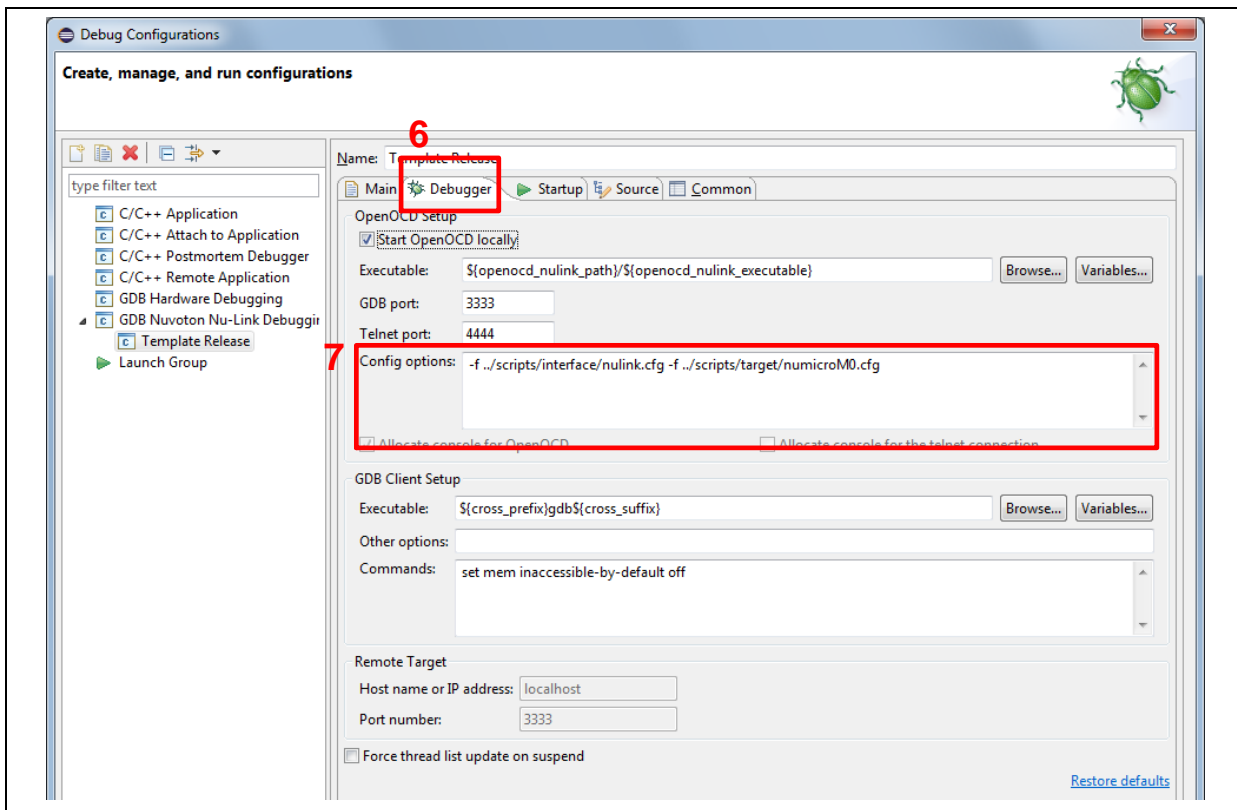
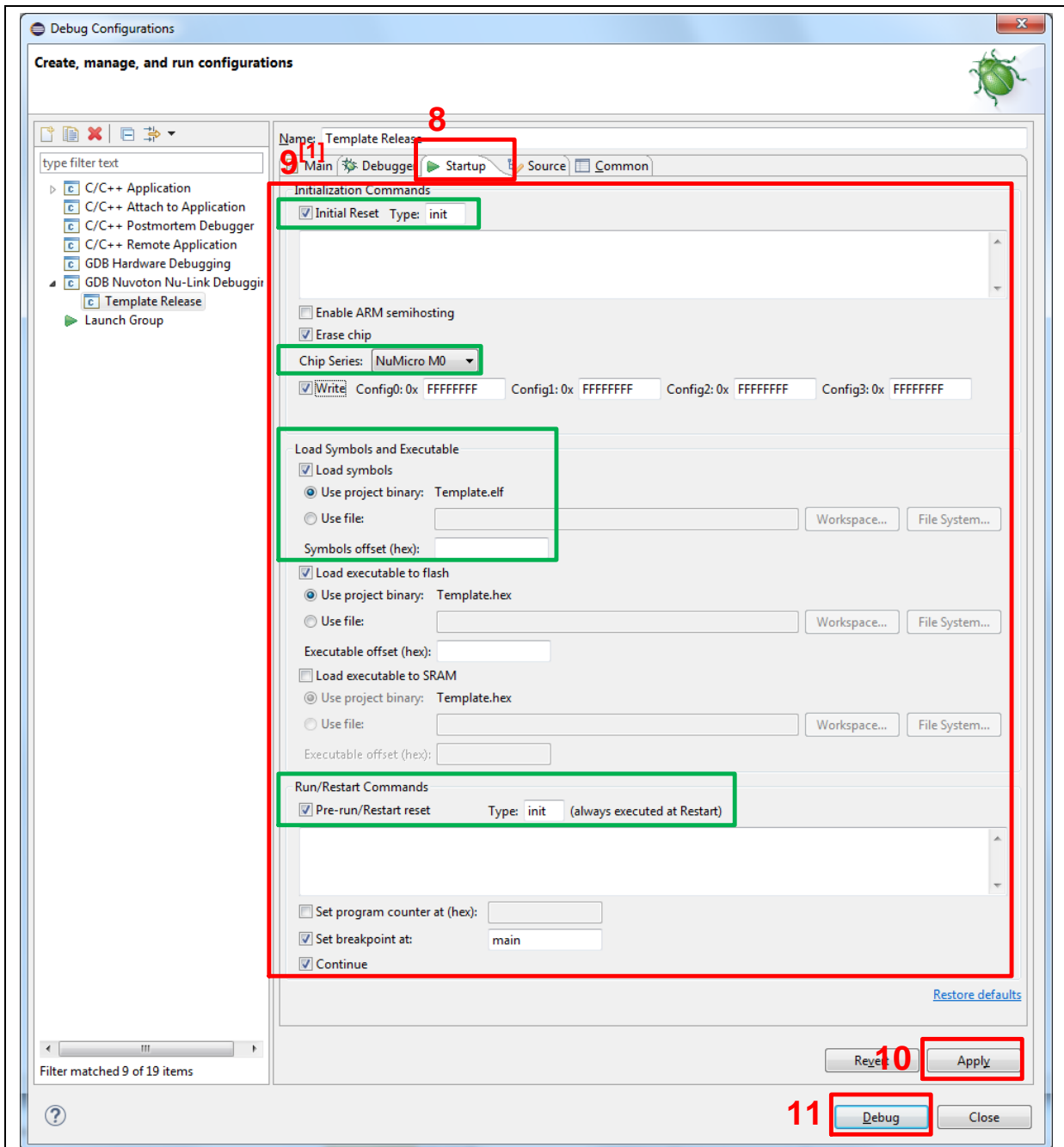

Figure 4-26 Debugger Tab Configuration



Note 1: User must follow those settings highlighted in green, and can configure other settings depend on the needs.

Figure 4-27 Startup Tab Configuration

- Figure 4-28 shows the debug mode under NuEclipse. Click “Resume” and the debug message will be printed out as shown in Figure 4-29. User can debug the project under debug mode by checking source code, assembly language, peripherals’ registers, and setting breakpoint, step run, value monitor, etc. For more information about how to use NuEclipse, please refer to the NuEclipse User Manual.

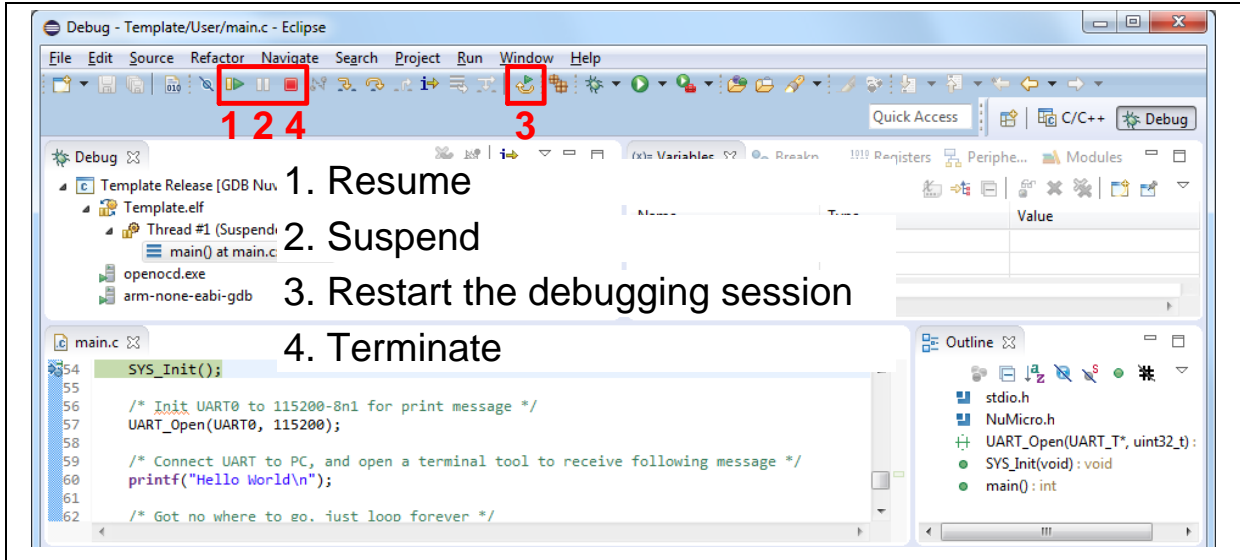

Figure 4-28 NuEclipse Debug Mode

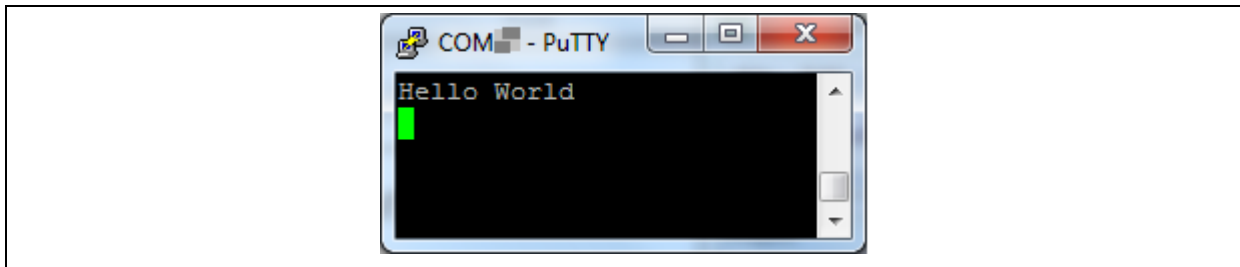

Figure 4-29 Debug Message on Serial Port Terminal Windows

5 NUMAKER-M251KG SCHEMATICS

5.1 Nu-Link2-Me

Figure 5-1 shows the Nu-Link2-Me circuit. The Nu-Link2-Me is a debugger and programmer that supports on-line programming and debugging through SWD interface.

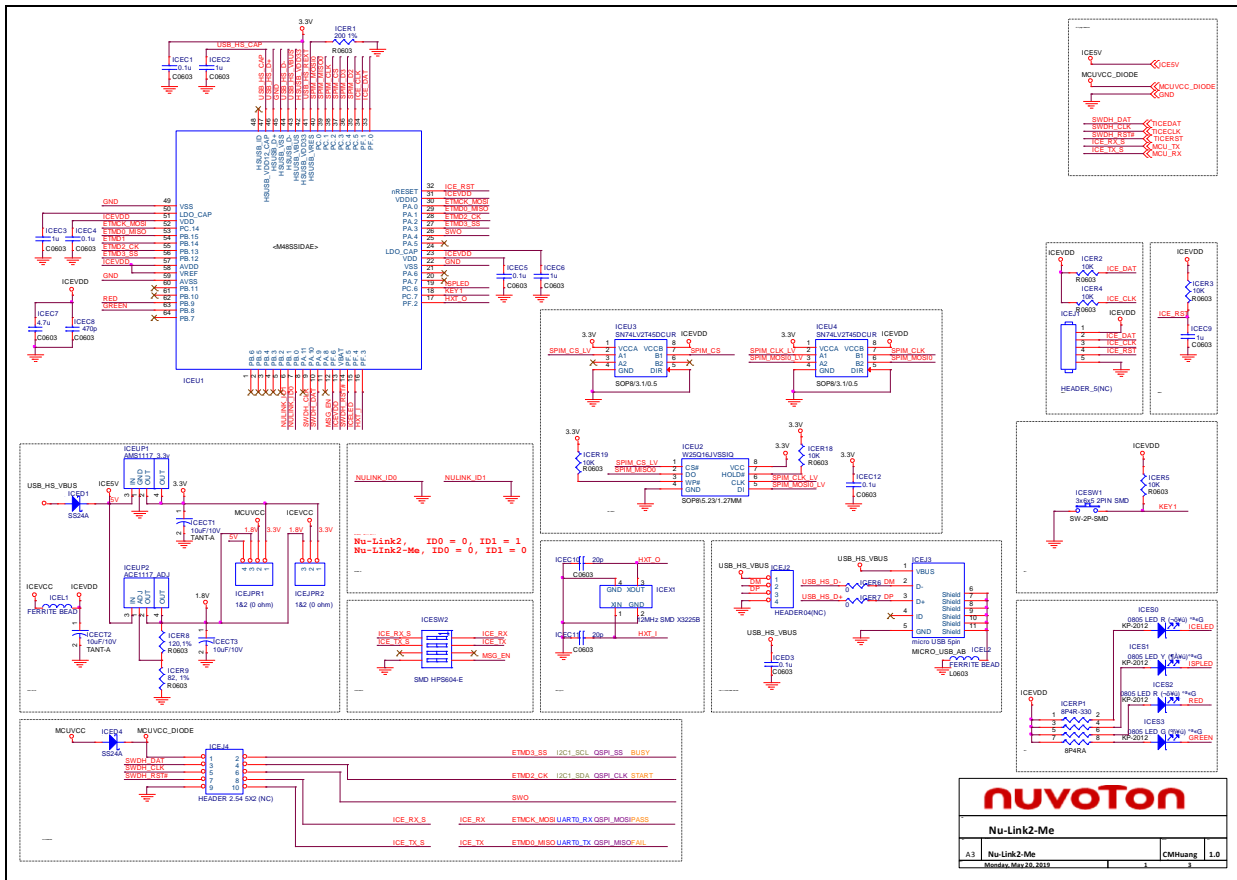

Figure 5-1 Nu-Link2-Me Circuit

5.5 PCB Placement

Figure 5-4 and Figure 5-5 show the front and rear placement of NuMaker-M251KG.

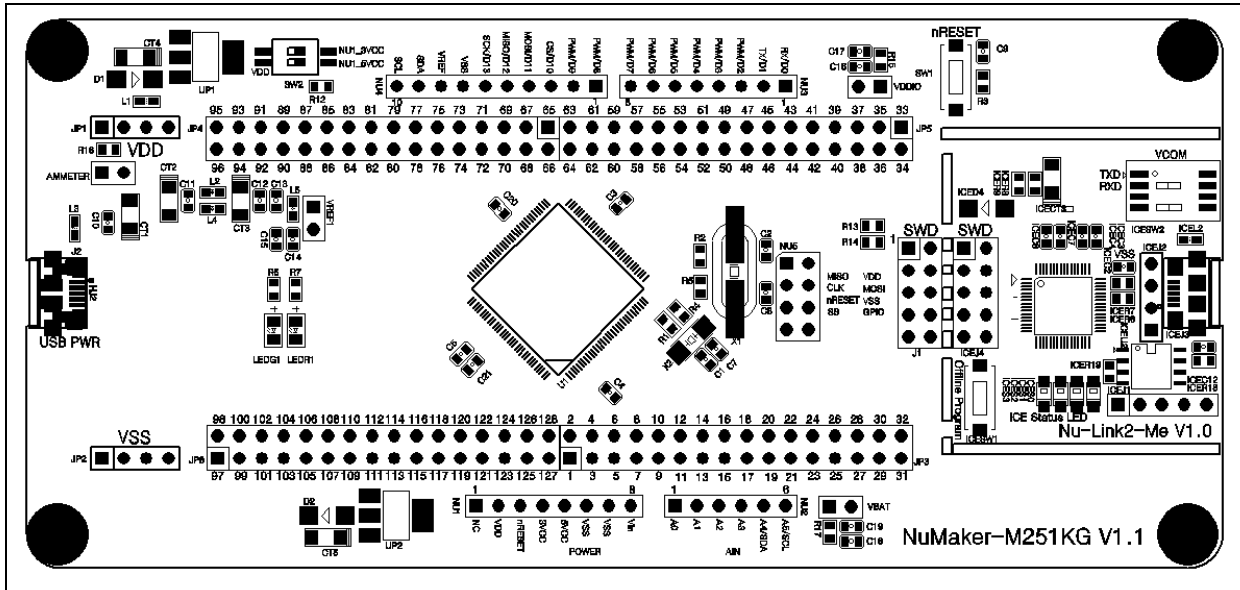

Figure 5-4 Front Placement

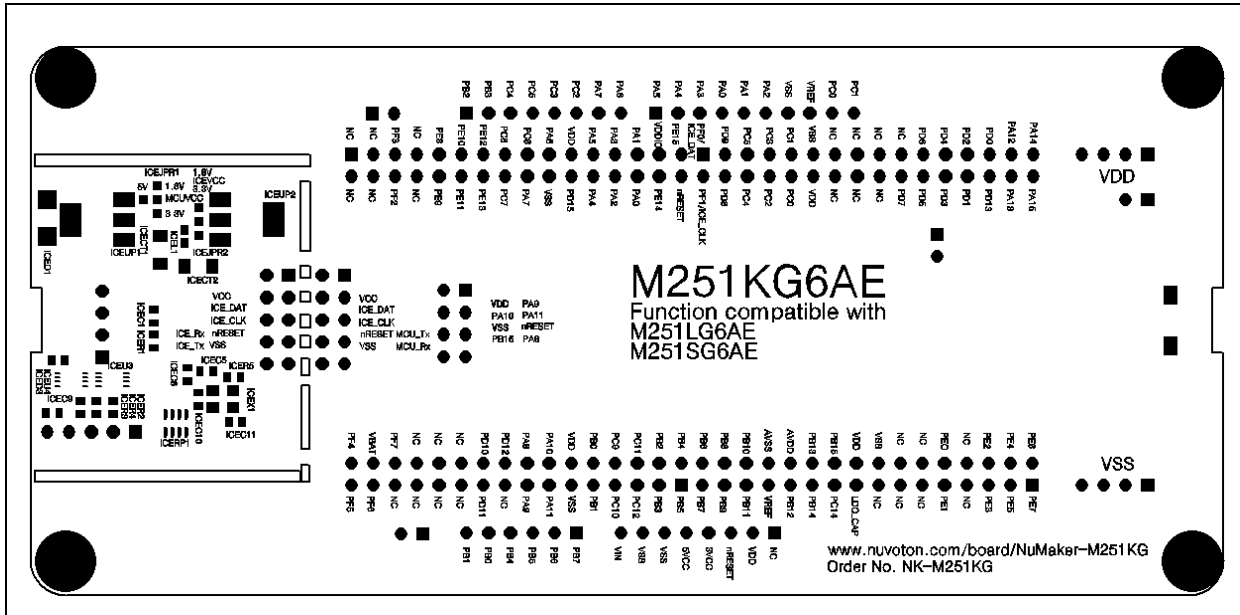

Figure 5-5 Rear Placement

NuMaker-M251KG USER MANUAL

6 REVISION HISTORY

Date	Revision	Description
2019.08.18	1.00	1. Initially issued.

Important Notice

Nuvoton Products are neither intended nor warranted for usage in systems or equipment, any malfunction or failure of which may cause loss of human life, bodily injury or severe property damage. Such applications are deemed, "Insecure Usage".

Insecure usage includes, but is not limited to: equipment for surgical implementation, atomic energy control instruments, airplane or spaceship instruments, the control or operation of dynamic, brake or safety systems designed for vehicular use, traffic signal instruments, all types of safety devices, and other applications intended to support or sustain life.

All Insecure Usage shall be made at customer's risk, and in the event that third parties lay claims to Nuvoton as a result of customer's Insecure Usage, customer shall indemnify the damages and liabilities thus incurred by Nuvoton.

*Please note that all data and specifications are subject to change without notice.
All the trademarks of products and companies mentioned in this datasheet belong to their respective owners.*