

PC 200/75 HG



Sample image

Order symbol: PC 200/75 HG

Product nbr: 6011326

UL Code: 6411326

UL Name: UL PC 200/75 HG

Description: Enclosure. PC

Remarks: Opaque cover

EAN: 6418074021977

El. number:

- Finland: 3421611
- Denmark: 8212022289
- Sweden: 6011326

Including: Base with TPE gasket, screws for mounting plate/DIN-rail and cover with polyamide cover screws.

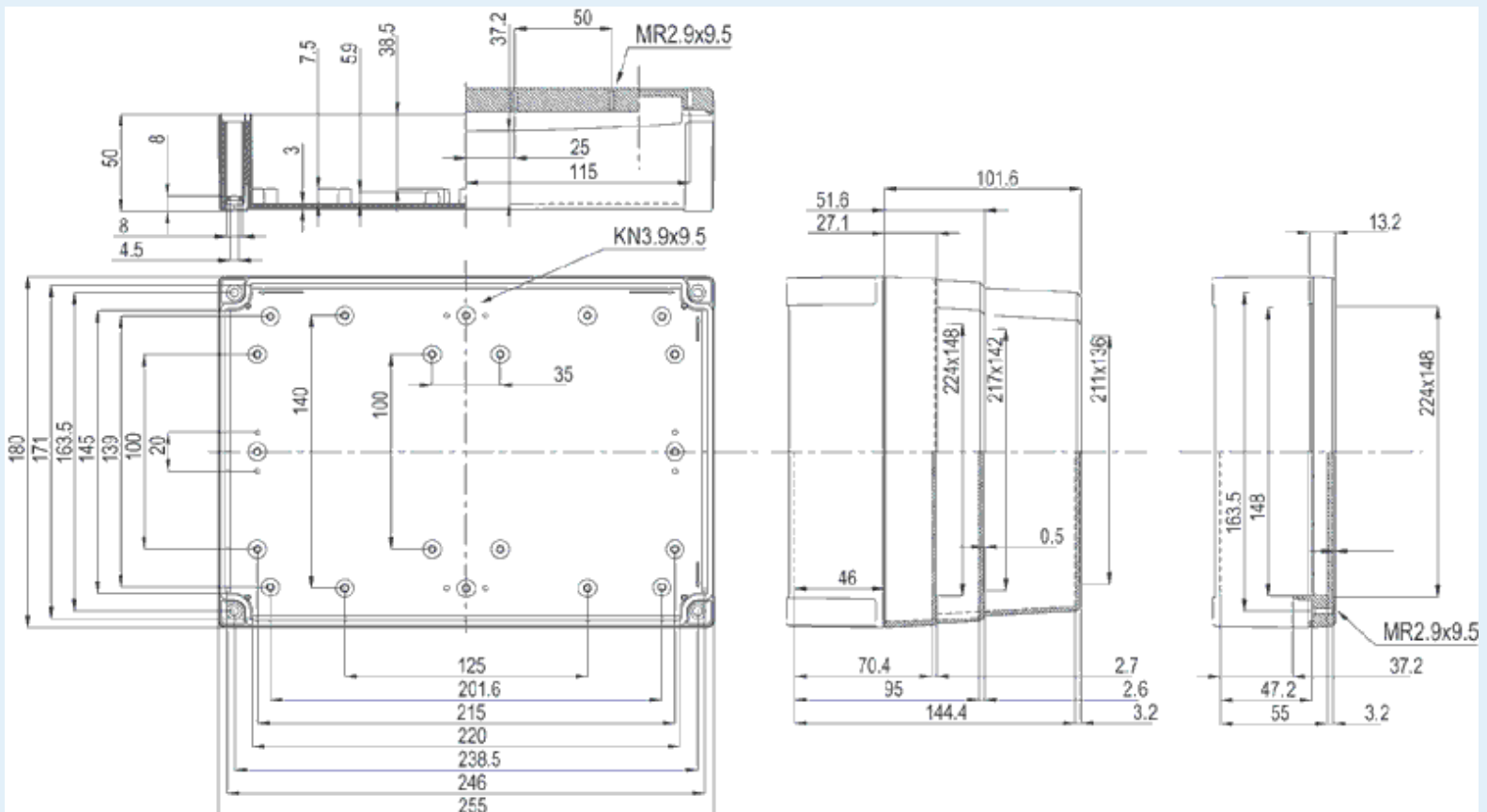

Dimensions:

	Height	Width	Depth
mm:	255	180	75
inch:	10.04	7.09	2.95

Materials:

Material:	Polycarbonate
Base colour:	RAL 7035 -light grey
Cover colour:	RAL 7035 -light grey
Gasket material:	Polyurethane

Temperatures:

Temperature °C (short term)::	-40 ... 120
Temperature °C (continuous):	-40 ... 80
Temperature °F (short term):	-40 ... 250
Temperature °F (continuous):	-40 ... 175

Accessories:

MIN 20	DIN-15 Mounting rail. for enclosures: (225 x 15 x 1)
HFP 180	Front panel hinge series
MIN 15	DIN-15 Mounting rail. for enclosures: (150 x 15 x 1)
MIV 200	Back Panel (Galvanized steel). for enclosures: (223 x 148 x 1)
FP A 200/180	Front panel (Aluminum). for enclosures: (237 x 170 x 1)
MIV 15	DIN-35 Mounting rail. for enclosures: (150 x 35 x 1)
FP 22046	Mounting foot kit (4 pcs)
MIV 20	DIN-35 Mounting rail. for enclosures: (225 x 35 x 1)

Rating:

Ingress protection (EN 60529):	IP66; IP67;
Impact Resistance (EN 62262):	IK08;
Electrical insulation:	Totally insulated
Halogen free (DIN/VDE 0472, Part 815):	1
UV resistance:	UL 508
Flammability Rating:	UL 746C 5"
Glow Wire Test (IEC 695-2-1) °C:	960 °C
NEMA Class	

Certificates:

Certificate FI 40847