

## Evaluation Board for Fractional-N/Integer-N PLL Frequency Synthesizer

### FEATURES

**Self-contained board including PLL, VCO, loop filter (20 kHz), 10 MHz TCXO reference, USB interface, and voltage regulators**

**Accompanying software allows control of synthesizer functions from a PC**

**Choice of power supply via USB or external feeding**

**Typical phase noise performance of  $-99$  dBc/Hz @ 1 kHz offset from carrier (1 GHz output frequency)**

### GENERAL DESCRIPTION

The EVAL-ADF4350EB2Z is designed to evaluate the performance of the [ADF4350](#) frequency synthesizer. A block diagram of the board is shown in Figure 1. It contains

the ADF4350 synthesizer, a USB connector and related interface, a 10 MHz TCXO reference source, SMA connectors for the RF outputs, and reference signal plus headers for various signals and voltages. There is also a loop filter (20 kHz) on board. A USB cable is included with the board to connect to a PC USB port.

The package also contains Windows® software (2000- and XP-compatible) to allow easy programming of the synthesizer.

### EVALUATION KIT CONTENTS

**Evaluation board software CD**

**USB cable**

**EVAL-ADF4350EB2Z**

### EVALUATION BOARD BLOCK DIAGRAM

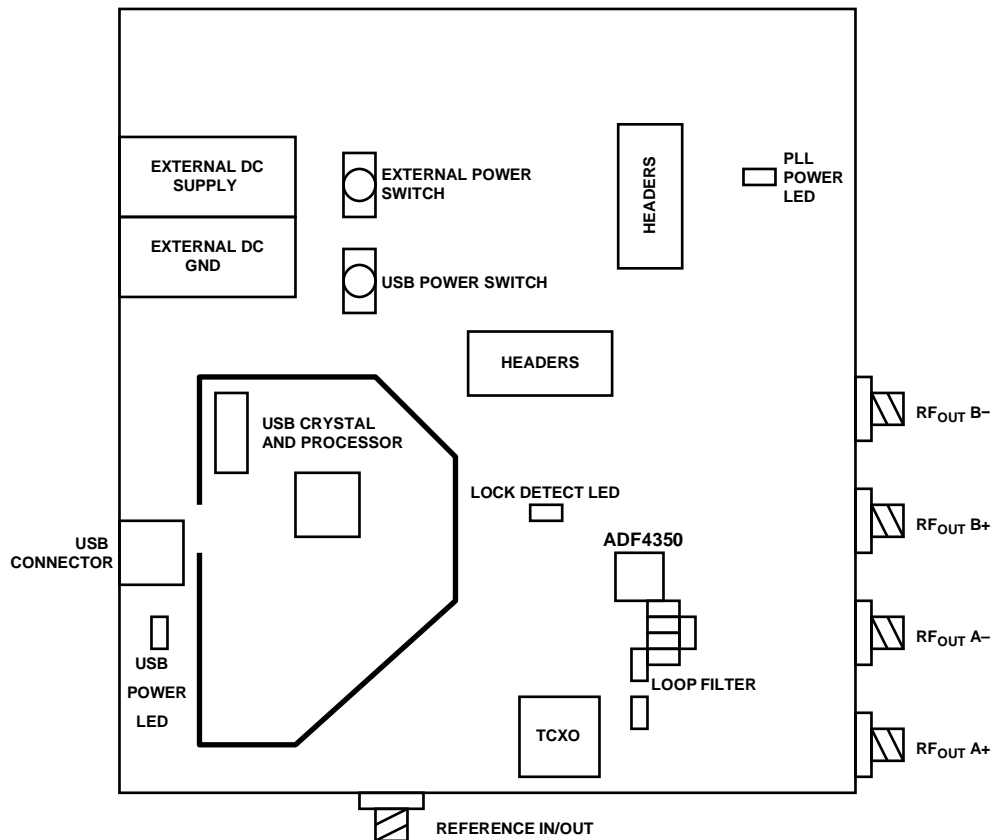

**TABLE OF CONTENTS**

Features .....	1	RF Output.....	3
General Description .....	1	Loop Filter .....	3
Evaluation Kit Contents.....	1	Reference Source .....	3
Evaluation Board Block Diagram.....	1	Evaluation Setup .....	4
Revision History .....	2	Evaluation Board Software.....	5
Evaluation Board Hardware .....	3	Evaluation Board Schematics and Artwork .....	6
Overview.....	3	Ordering Information.....	10
Power Supplies .....	3	Bill of Materials.....	10

**REVISION HISTORY**

3/10—Revision 0: Initial Version

## EVALUATION BOARD HARDWARE

### OVERVIEW

The EVAL-ADF4350EB2Z comes with a cable for connecting to the USB port of a PC. The silk screen for the evaluation board is shown in Figure 8. The board schematic is shown in Figure 5, Figure 6, and Figure 7.

### POWER SUPPLIES

The EVAL-ADF4350EB2Z can be powered either from the USB port or via dc power connectors (4 mm banana connectors). When feeding via banana connectors, 3.75 V to 11 V is a suitable feeding voltage. The power supply circuitry allows the user to use one, two, or three separate LDOs to feed the ADF4350 (using fewer LDOs increases the risk of spur contaminated dc feeds). Consult the board schematic in Figure 5, Figure 6, and Figure 7 to determine a suitable jumper setting on Header J7.

An LED, D6, indicates when USB power is available, and another LED, D5, indicates when the ADF4350 is powered. Switch SW1 is used to power the ADF4350 from the USB port and Switch SW2 is used to power the part from the external dc connectors.

In case the USB processor or clock causes spurs on the RF output signal, the user may feed the evaluation board via the dc connectors and unplug the USB cable, thereby removing power from the USB interface circuitry. There is also a grounded frame surrounding the USB interface circuitry to allow mounting of a shielding box.

The J8 to J13 connectors can be populated if the user wishes to measure any spectral contamination on a specific dc voltage. Otherwise, the voltages are also present on either Header J6 or Header J7 for easy access and measurements.

### RF OUTPUT

The EVAL-ADF4350EB2Z has four SMA output connectors (dual differential output). The device is quite sensitive to impedance unbalance. If only one port of a differential pair is used, terminate the other with a 50  $\Omega$  load.

### LOOP FILTER

The loop filter schematic is included in the board schematic on Figure 5. The loop filter component placements are clarified in Figure 2.

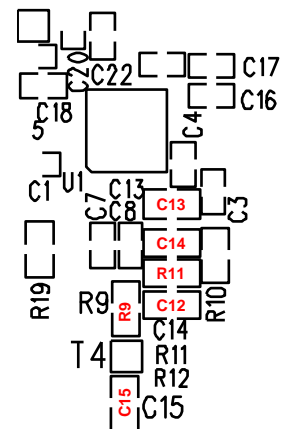

Figure 2. Loop Filter Placement

### REFERENCE SOURCE

The 10 MHz TCXO from Fox Electronics provides the necessary reference signal. An external REFIN may be used if desired. In this case, disable the on-board TCXO by removing R1 and R2. R3 can be populated with 50  $\Omega$  to adjust impedance matching of the evaluation board to the external reference source.

### EVALUATION SETUP

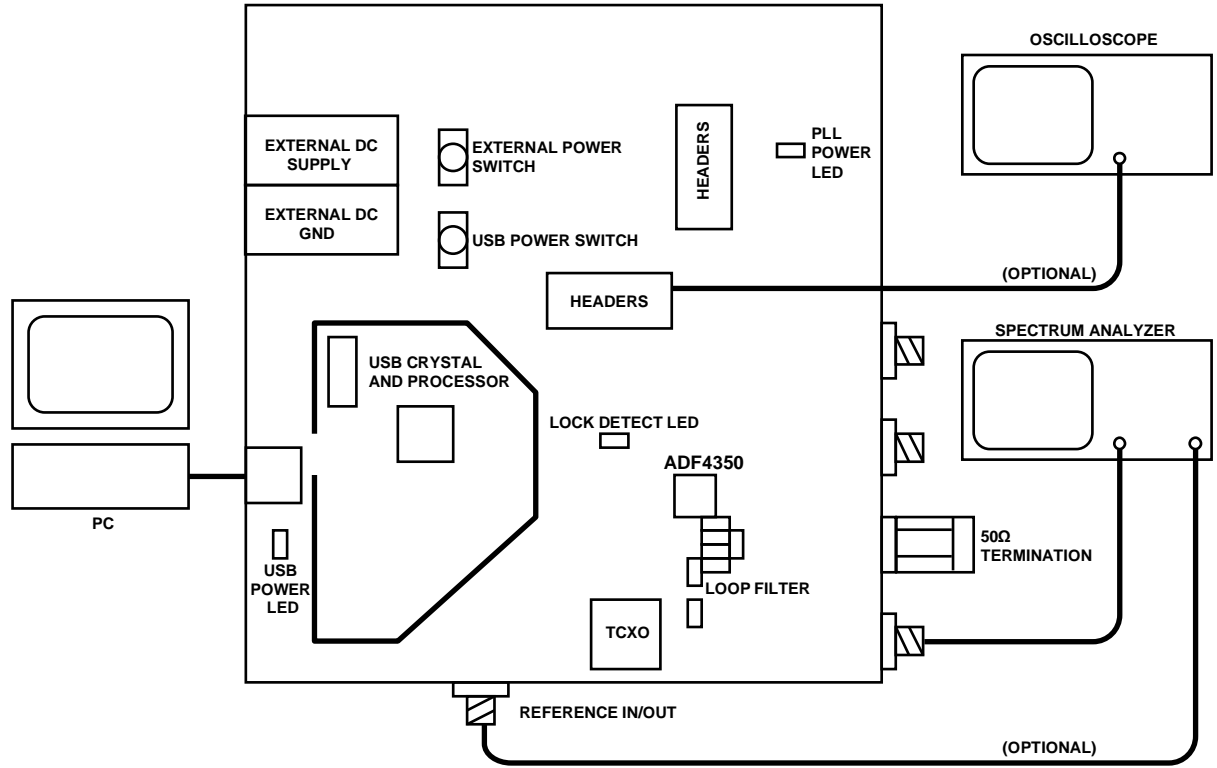

Figure 3. Evaluation Setup

09809-007

## EVALUATION BOARD SOFTWARE

The control software for the EVAL-ADF4350 accompanies the EVAL-ADF4350EB2Z on a CD. To install the software, use the following steps:

1. Click **setup.exe**.
2. The install wizard guides you through the installation process. The software is installed in a default directory called **C:/Program Files/Analog Devices/ADF4350**.
3. To run the software, click the **.exe** file.

The main interface window appears (see Figure 4). Confirm that **USB OK** is displayed on the right side of the screen. Otherwise, the software has no connection to the evaluation board.

It is also possible to disconnect the USB by clicking the **Disconnect USB** button. Should this happen, no data is sent to the part. This function is to be used before disconnecting the board from the USB connection. When the board is connected again, click the **USB connect** button to enable the programming of the part. This ensures the PC does not freeze up when the USB cable is disconnected.

Use the **Reference** section to set the correct reference frequency and reference frequency divider. The reference TCXO on the evaluation board runs at 10 MHz. To force the device to operate in integer-N mode, set the R divider so that the PFD frequency (displayed in the **Settings** section) equals the channel spacing

(set in the **Output Frequency** section) and select the **Integer-N when possible** check box (in the **Options** section).

The **Outputs** section controls the charge pump current setting, the output power setting, and the multiplexer output setting.

Use the **Output Frequency** section to control the output frequency. You may specify two frequencies, and select which one the device operates at. For some frequencies, the device can operate in two modes: the low end of the VCO band or the high end, plus an extra divide by two. To control which mode is used, select **Minimum Output Divider** in the **Options** section.

The device can be set to toggle between the two set frequencies by selecting **Alternate** in the **Dynamic** section. The time spent on each frequency is set in the **Approximate Delay** field. To stop, click **Stop**. It is also possible to sweep from f1 to f2 with the channel spacing resolution with an approximate time delay on each frequency.

It is also possible to select **Low Spur Mode** or **Low Noise Mode** for the frac-N mode in the **Options** section. You can also set the cycle slip reduction bit.

The **Settings** section displays selected settings. Click **Registers** to display every bit of the register settings. To download these to the device, click **Update ALL**.

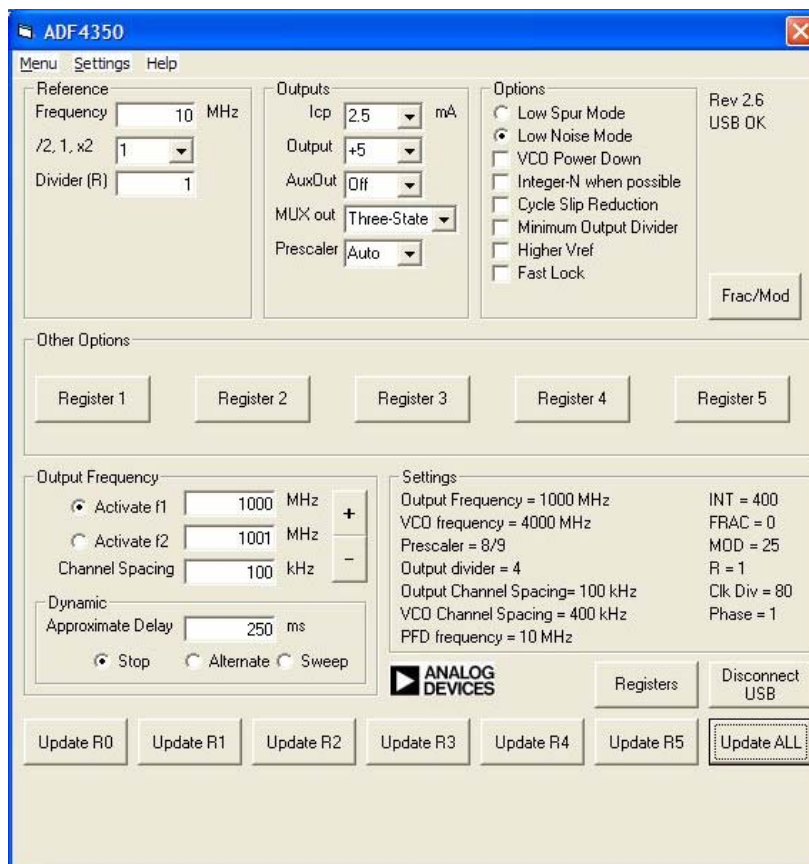
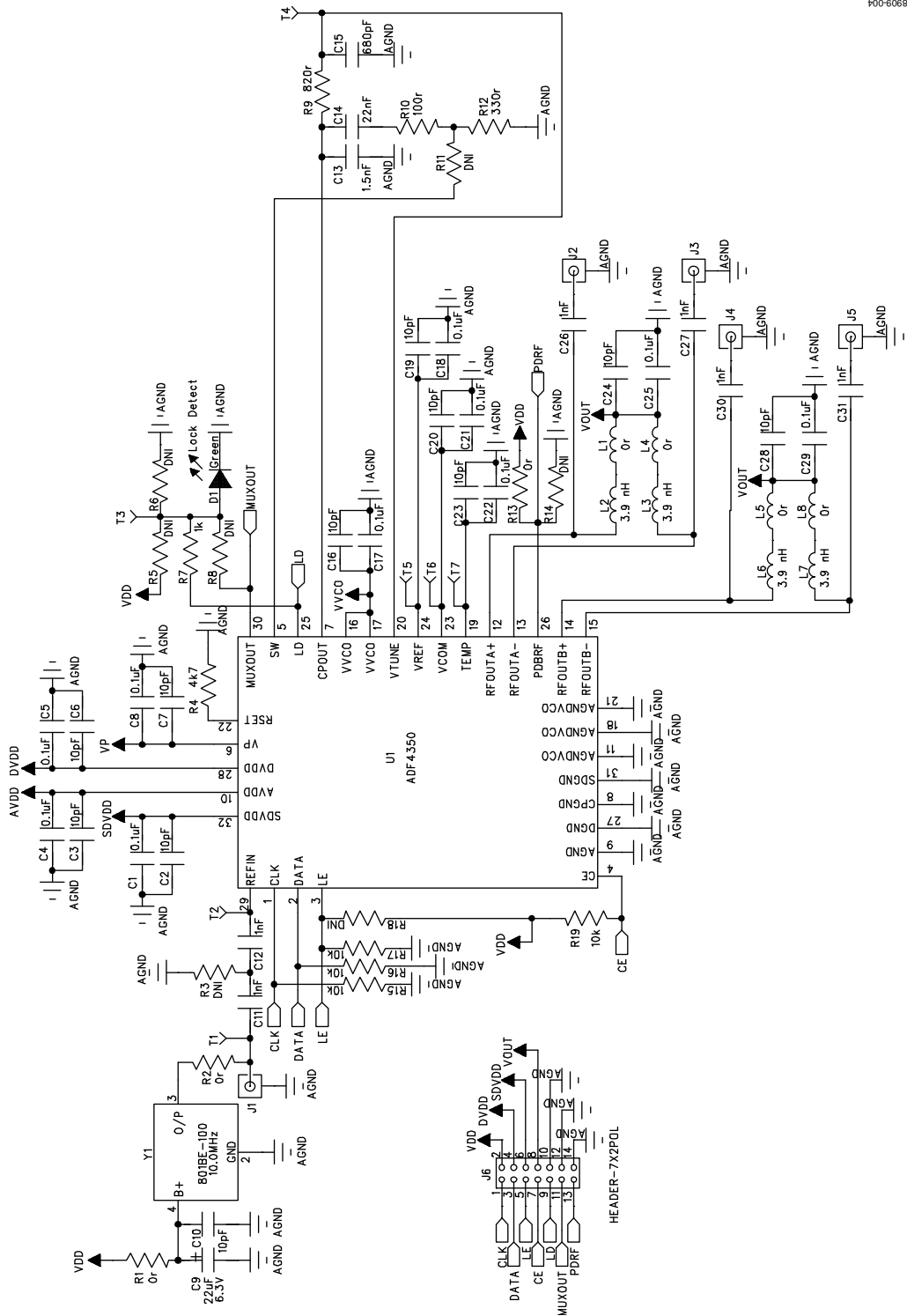

Figure 4. Software Front Panel

EVALUATION BOARD SCHEMATICS AND ARTWORK



100-60680

Figure 5. Evaluation Board Schematic (Page 1)

500-60680

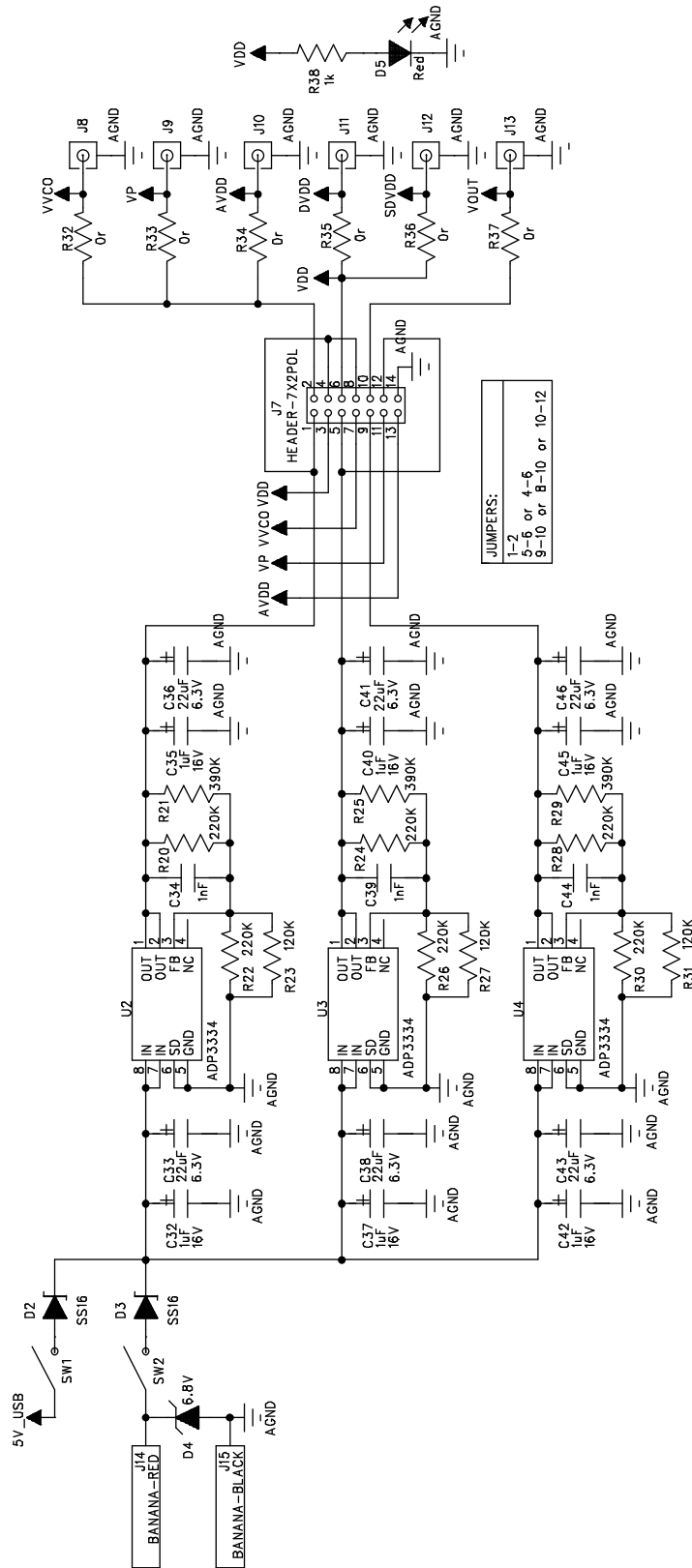

Figure 6. Evaluation Board Schematic (Page 2)

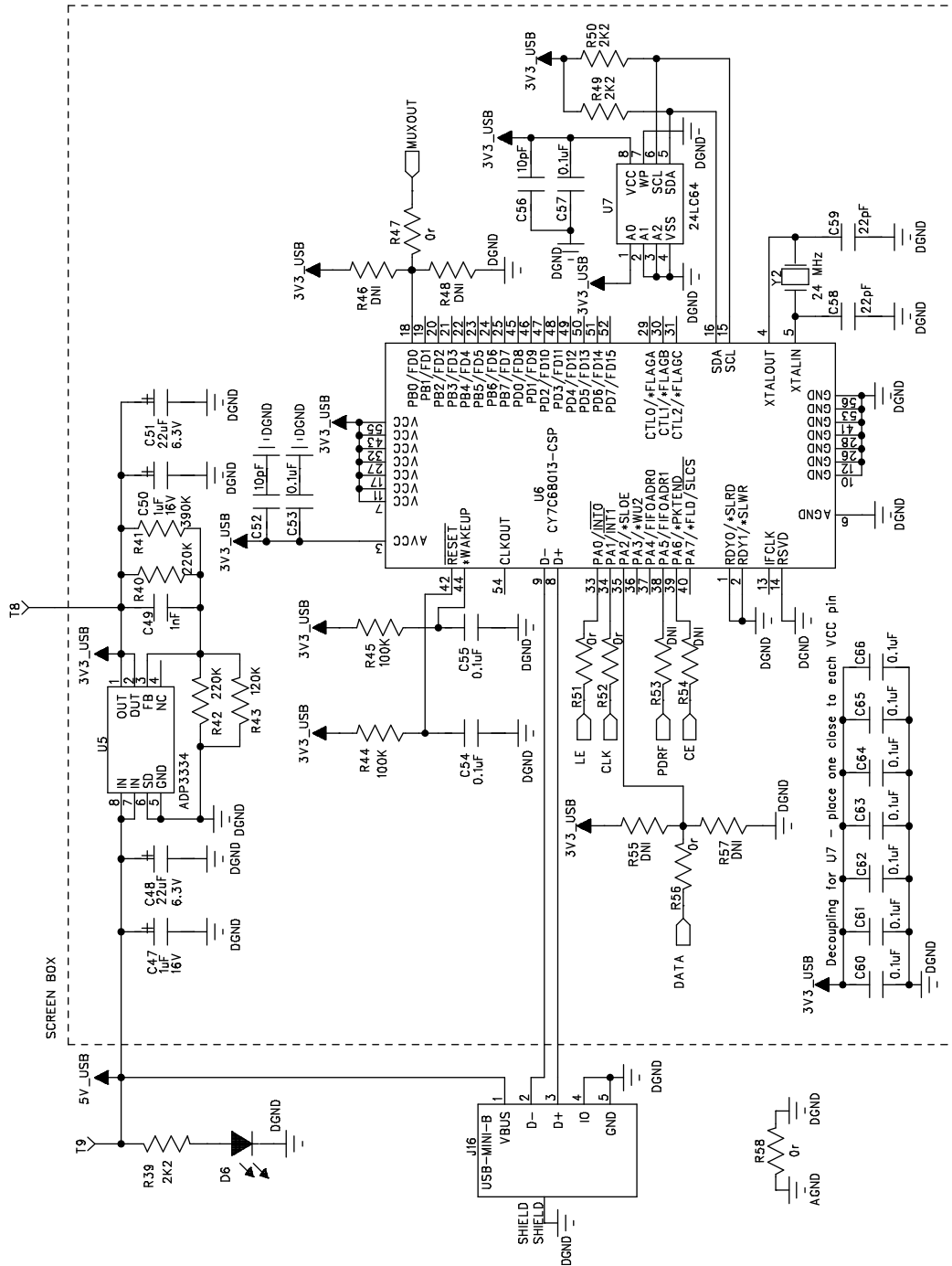

Figure 7. Evaluation Board Schematic (Page 3)



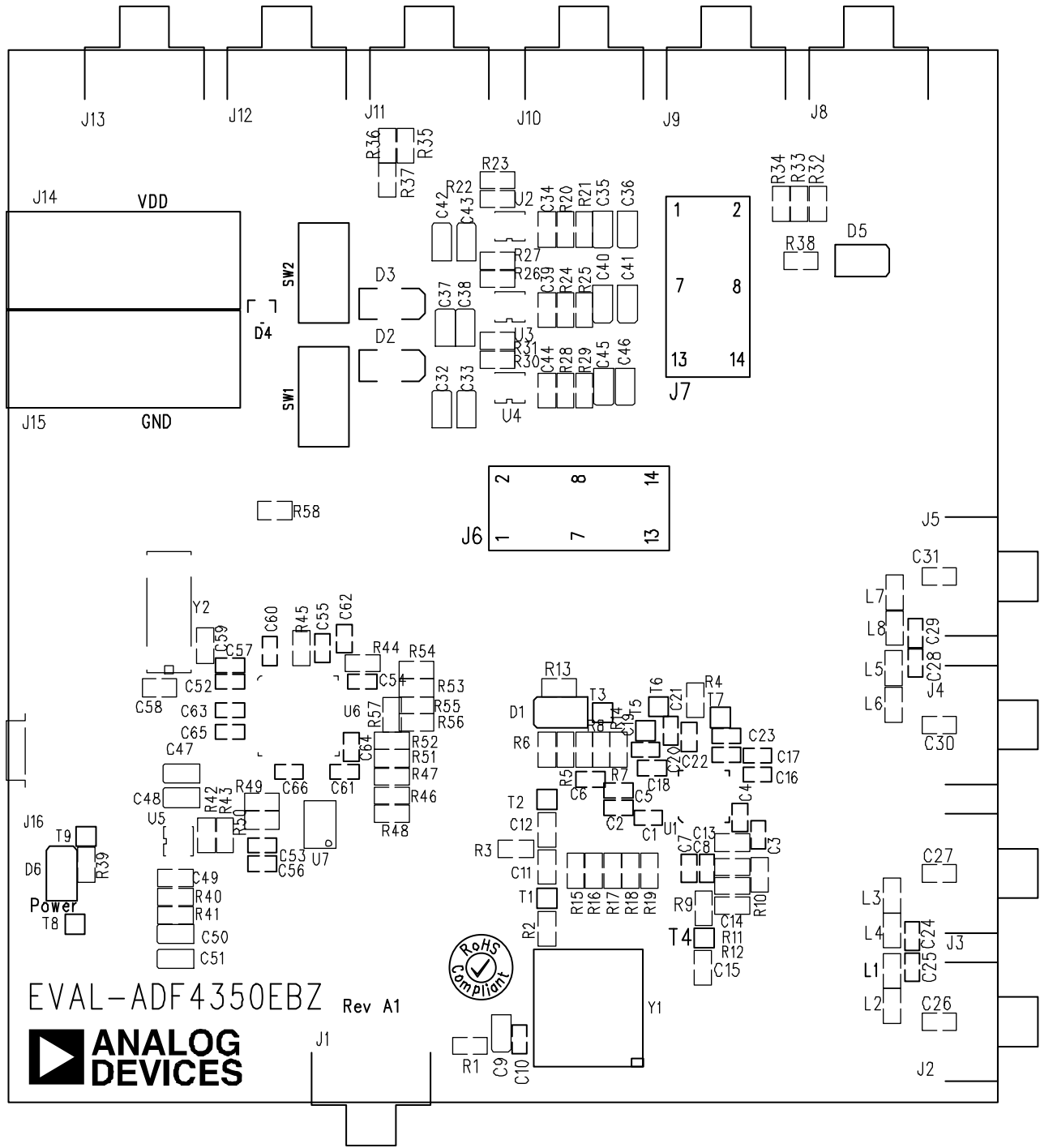

Figure 8. Evaluation Board Silk Screen

## ORDERING INFORMATION

## BILL OF MATERIALS

Table 1.

Qty	Reference Designator	Description
21	C1, C4, C5, C8, C17, C18, C21, C22, C25, C29, C53, C54, C55, C57, C60, C61, C62, C63, C64, C65, C66	Capacitor, 0.1 $\mu$ F, 10%, 0402, 16 V, X7R
13	C2, C3, C6, C7, C10, C16, C19, C20, C23, C24, C28, C52, C56	Capacitor, 10 pF, 5%, 0402, 50 V, NPO
9	C9, C33, C36, C38, C41, C43, C46, C48, C51	Capacitor+, 22 $\mu$ F, 10%, TAJ_A, 6.3 V, tantalum
10	C11, C12, C26, C27, C30, C31, C34, C39, C44, C49	Capacitor, 1 nF, 10%, 0603, 50 V, X7R
1	C13	Capacitor, 1.5 nF, 10%, 0603, 50 V, X7R
3	C14, C58, C59	Capacitor, 22 nF, 10%, 0603, 50 V, X7R
1	C15	Capacitor, 680 pF, 10%, 0603, 50 V, X7R
8	C32, C35, C37, C40, C42, C45, C47, C50	Capacitor+, 1 $\mu$ F, 10%, TAJ_A, 16 V, tantalum
1	D1	LED_CHIP, light emitting diode
2	D2, D3	SS16, DO-214AC, Schottky diode, -1 A, 60 V
1	D4	Zener-diode-S, 6.8 V, 5%, SOT23, OT23
2	D5, D6	LED, LED_CHIP, light emitting diode
5	J1, J2, J3, J4, J5	SMA, SMA_CARD_EDGE_RF
2	J6, J7	HEADER-7X2POL, HEADER14-POL
6	J8 to J13	DNI, SMA_CARD_EDGE_RF
1	J14	Red, 4 mm, banana socket
1	J15	Black, 4 mm, banana socket
1	J16	USB mini-B connector (usb-otg)
4	L1, L4, L5, L8	Inductor, 0 $\Omega$ , 1%, 0603
4	L2, L3, L6, L7	Inductor, 3.9 nH, 5%, 0603, Coilcraft 0603CS
14	R1, R2, R13, R32, R33, R34, R35, R36, R37, R47, R51, R52, R56, R58	Resistor, 0 $\Omega$ , 1%, 0603
13	R3, R5, R6, R8, R11, R14, R18, R46, R48, R53, R54, R55, R57	Resistor, DNI, 1%, 0603
1	R4	Resistor, 4.7 k $\Omega$ , 1%, 0603
2	R7, R38	Resistor, 1 k $\Omega$ , 1%, 0603
1	R9	Resistor, 820 $\Omega$ , 1%, 0603
1	R10	Resistor, 100 $\Omega$ , 1%, 0603
1	R12	Resistor, 330 $\Omega$ , 1%, 0603
4	R15, R16, R17, R19	Resistor, 10 k $\Omega$ , 1%, 0603
8	R20, R22, R24, R26, R28, R30, R40, R42	Resistor, 220 k $\Omega$ , 1%, 0603
4	R21, R25, R29, R41	Resistor, 390 k $\Omega$ , 1%, 0603
4	R23, R27, R31, R43	Resistor, 120 k $\Omega$ , 1%, 0603
3	R39, R49, R50	Resistor, 2.2 k $\Omega$ , 1%, 0603
2	R44, R45	Resistor, 100 k $\Omega$ , 1%, 0603
2	SW1, SW2	SW_POWER, SW_SIP-3P, NKK SPST N/O momentary push button switch
9	T1 to T9	Testpoint
1	U1	ADF4350, LFCSP-32 PLL
4	U2 to U5	ADP3334 MSO8 adjustable LDO regulator
1	U6	CY7C68013-CSP, LFCSP-56, USB microcontroller
1	U7	24LC64, SO8NB, 64K I <sup>2</sup> C serial EEPROM
1	Y1	OSC_TCXO, 10.0 MHz, OSC_TCXO, FOX
1	Y2	XTAL-CM309S, 24 MHz, XTAL_CM309S, CM309S SMD crystal

**NOTES**

## NOTES

**ESD Caution**

**ESD (electrostatic discharge) sensitive device.** Charged devices and circuit boards can discharge without detection. Although this product features patented or proprietary protection circuitry, damage may occur on devices subjected to high energy ESD. Therefore, proper ESD precautions should be taken to avoid performance degradation or loss of functionality.

**Legal Terms and Conditions**

By using the evaluation board discussed herein (together with any tools, components documentation or support materials, the "Evaluation Board"), you are agreeing to be bound by the terms and conditions set forth below ("Agreement") unless you have purchased the Evaluation Board, in which case the Analog Devices Standard Terms and Conditions of Sale shall govern. Do not use the Evaluation Board until you have read and agreed to the Agreement. Your use of the Evaluation Board shall signify your acceptance of the Agreement. This Agreement is made by and between you ("Customer") and Analog Devices, Inc. ("ADI"), with its principal place of business at One Technology Way, Norwood, MA 02062, USA. Subject to the terms and conditions of the Agreement, ADI hereby grants to Customer a free, limited, personal, temporary, non-exclusive, non-sublicensable, non-transferable license to use the Evaluation Board FOR EVALUATION PURPOSES ONLY. Customer understands and agrees that the Evaluation Board is provided for the sole and exclusive purpose referenced above, and agrees not to use the Evaluation Board for any other purpose. Furthermore, the license granted is expressly made subject to the following additional limitations: Customer shall not (i) rent, lease, display, sell, transfer, assign, sublicense, or distribute the Evaluation Board; and (ii) permit any Third Party to access the Evaluation Board. As used herein, the term "Third Party" includes any entity other than ADI, Customer, their employees, affiliates and in-house consultants. The Evaluation Board is NOT sold to Customer; all rights not expressly granted herein, including ownership of the Evaluation Board, are reserved by ADI. CONFIDENTIALITY. This Agreement and the Evaluation Board shall all be considered the confidential and proprietary information of ADI. Customer may not disclose or transfer any portion of the Evaluation Board to any other party for any reason. Upon discontinuation of use of the Evaluation Board or termination of this Agreement, Customer agrees to promptly return the Evaluation Board to ADI. ADDITIONAL RESTRICTIONS. Customer may not disassemble, decompile or reverse engineer chips on the Evaluation Board. Customer shall inform ADI of any occurred damages or any modifications or alterations it makes to the Evaluation Board, including but not limited to soldering or any other activity that affects the material content of the Evaluation Board. Modifications to the Evaluation Board must comply with applicable law, including but not limited to the RoHS Directive. TERMINATION. ADI may terminate this Agreement at any time upon giving written notice to Customer. Customer agrees to return to ADI the Evaluation Board at that time. LIMITATION OF LIABILITY. THE EVALUATION BOARD PROVIDED HEREUNDER IS PROVIDED "AS IS" AND ADI MAKES NO WARRANTIES OR REPRESENTATIONS OF ANY KIND WITH RESPECT TO IT. ADI SPECIFICALLY DISCLAIMS ANY REPRESENTATIONS, ENDORSEMENTS, GUARANTEES, OR WARRANTIES, EXPRESS OR IMPLIED, RELATED TO THE EVALUATION BOARD INCLUDING, BUT NOT LIMITED TO, THE IMPLIED WARRANTY OF MERCHANTABILITY, TITLE, FITNESS FOR A PARTICULAR PURPOSE OR NON-INFRINGEMENT OF INTELLECTUAL PROPERTY RIGHTS. IN NO EVENT WILL ADI AND ITS LICENSORS BE LIABLE FOR ANY INCIDENTAL, SPECIAL, INDIRECT, OR CONSEQUENTIAL DAMAGES RESULTING FROM CUSTOMER'S POSSESSION OR USE OF THE EVALUATION BOARD, INCLUDING BUT NOT LIMITED TO LOST PROFITS, DELAY COSTS, LABOR COSTS OR LOSS OF GOODWILL. ADI'S TOTAL LIABILITY FROM ANY AND ALL CAUSES SHALL BE LIMITED TO THE AMOUNT OF ONE HUNDRED US DOLLARS (\$100.00). EXPORT. Customer agrees that it will not directly or indirectly export the Evaluation Board to another country, and that it will comply with all applicable United States federal laws and regulations relating to exports. GOVERNING LAW. This Agreement shall be governed by and construed in accordance with the substantive laws of the Commonwealth of Massachusetts (excluding conflict of law rules). Any legal action regarding this Agreement will be heard in the state or federal courts having jurisdiction in Suffolk County, Massachusetts, and Customer hereby submits to the personal jurisdiction and venue of such courts. The United Nations Convention on Contracts for the International Sale of Goods shall not apply to this Agreement and is expressly disclaimed.