

5A, 22V Bidirectional Load Switch with Fast Role Swap

Features

- Integrated N-Channel Load Switch
- Fast Role Swap Capability that meets the USB Power Delivery Specification Requirements
- 2.85 to 22V Bidirectional Load Switch Input Voltage Range (supply voltage can be V_{IN} or V_{OUT})
- 5A Continuous Current
- 30 m Ω Typical On Resistance
- Configurable Current Limit Threshold with External Resistor
- Scaled Analog Voltage Output of Current Flowing through Switch for External Measurement
- Auto-Recovery Fault Handling or Latch Mode
- Configurable Overvoltage Lockout
- Back-Voltage Protection
- Output Voltage Slew Rate Control
- Configurable Quick Output Discharge
- Overtemperature Protection (thermal shutdown)
- Packages: 19-Lead 3 x 3 x 0.9 mm VQFN

Applications

- USB Power Delivery
- Consumer, Industrial and Automotive Power Protection

Description

The UCS3205 is 5A, 22V load switch with Fast Role Swap (FRS) capability, bidirectional current capability, configurable overcurrent limiting, auto-recovery Fault handling, overvoltage lockout, back-voltage protection, slew rate control, quick output discharge and a scaled analog output of the forward current passing through the switch.

Package Type

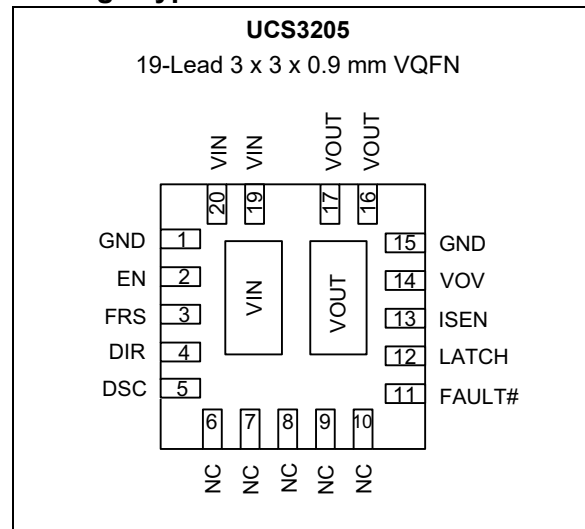

UCS3205

Block Diagram

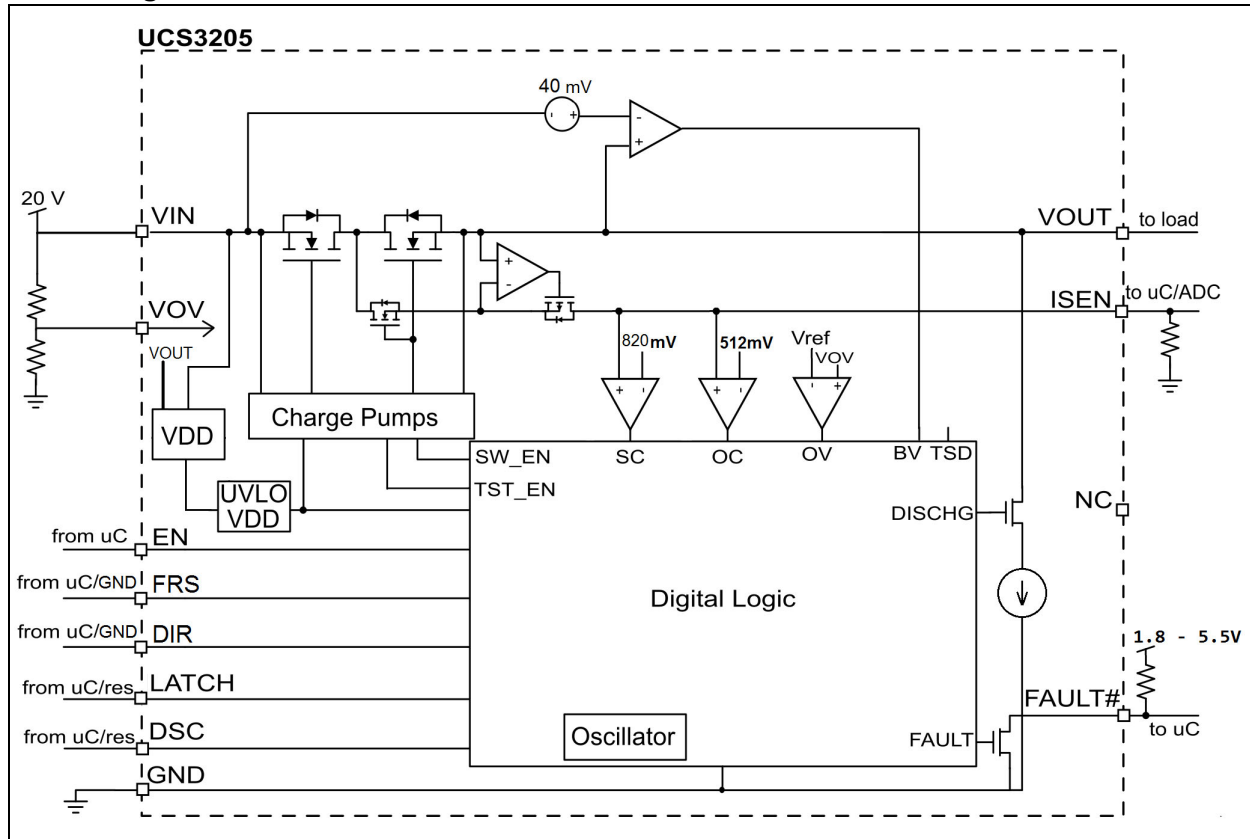

1.0 ELECTRICAL CHARACTERISTICS

Absolute Maximum Ratings†

Voltage on VIN and VOUT Pins	-0.3V to 25V
FAULT# Pin Pull-up Voltage (V _{PULLUP}).....	-0.3V to 6V
Port Power Switch Current.....	Internally Limited
Voltage on Any Other Pin to Ground.....	-0.3V to 6V
Current on the FAULT# Pin.....	10 mA
Operating Junction Temperature.....	-40°C to +125°C
Storage Temperature Range.....	-55°C to +150°C
Package Power Dissipation	67°C/W
ESD Protection on VIN, VOUT, GND Pins (IEC 61000-4-2).....	±15 kV
ESD Protection on VIN, VOUT, GND Pins (JEDEC JESD22-A114; Human Body Model).....	±6 kV
ESD Protection on All Other Pins (JEDEC JESD22-A114; Human Body Model)	±2 kV
ESD Protection on All Pins (JEDEC JESD22-C101; Charge Device Model).....	±500V

† **NOTICE:** Stresses above those listed under “Maximum ratings” may cause permanent damage to the device. This is a stress rating only and functional operation of the device at those or any other conditions above those indicated in the operational listings of this specification is not implied. Exposure to maximum rating conditions for extended periods may affect device reliability.

ELECTRICAL CHARACTERISTICS

Electrical Specifications: Unless otherwise indicated, T _A = +25°C, V _{IN} or V _{OUT} = 2.85V to 22V.						
Characteristic	Symbol	Min.	Typ.	Max.	Unit	Conditions
Power and Interrupts – DC						
Minimum Start-up Supply Voltage	V _{IN_STRT}	3.1	—	—	V	
Minimum Supply Voltage After Start-up	V _{IN}	2.85	—	—	V	
Minimum Start-up Supply Voltage	V _{OUT_STRT}	3.1	—	—	V	
Minimum Supply Voltage After Start-up	V _{OUT}	2.85	—	—	V	
Quiescent Current	I _Q	—	200	260	µA	Current measured into VIN or VOUT when current out of VOUT or VIN, respectively, is 0A, EN = ‘high’
Shutdown Current	I _{SD}	—	20	30	µA	Current measured in the VIN pin when EN and DSC pins are ‘low’

Note 1: This parameter is characterized, not 100% tested.

2: This parameter is ensured by design.

UCS3205

ELECTRICAL CHARACTERISTICS (CONTINUED)

Electrical Specifications: Unless otherwise indicated, $T_A = +25^\circ\text{C}$, V_{IN} or $V_{OUT} = 2.85\text{V}$ to 22V .						
Characteristic	Symbol	Min.	Typ.	Max.	Unit	Conditions
Power-on Reset						
VIN, VOUT Undervoltage Lockout Threshold	V_{UV_HIGH}	2.25	—	2.45	V	
VIN, VOUT Undervoltage Lockout Threshold	V_{UV_LOW}	2.05	—	2.24	V	
VIN, VOUT Undervoltage Lockout Hysteresis	V_{UVLO_HYS}	—	150	—	mV	
I/O Pins – FRS, DIR, EN, LATCH, DSC, FAULT#, VOV						
Output Low Voltage	V_{OL}	—	—	0.4	V	$I_{SINK_IO} = 8\text{ mA}$, FAULT#
Input High Voltage	V_{IH}	1.26	—	—	V	EN, LATCH, DSC, FRS, DIR
Input Low Voltage	V_{IL}	—	—	0.54	V	EN, LATCH, DSC, FRS, DIR
Leakage Current	I_{LEAK}	—	—	± 10	μA	Powered or unpowered, $V_{PULLUP} \leq (1.8\text{V}-5.5\text{V})$ (Note 1)
Oversvoltage Sense Threshold	V_{OV}	1.225	1.25	1.275	V	
Switch Turn-On Delay for FRS	t_{FRS_SWAP}	—	—	60	μs	$V_{IN} = 5\text{V}$, $C_{IN} = 100\ \mu\text{F}$, $C_{OUT} = 10\ \mu\text{F}$, $V_{OUT} \geq 90\%$ of V_{IN} (Note 1)
FRS Pre-Arm Ready Time	t_{FRS_PREARM}	—	200	270	μs	Minimum FRS hold time before EN = 1, $V_{IN} > V_{UV_HIGH}$
Digital Input Deglitch Time	t_{DIG_HOLD}	—	20	—	μs	Digital input hold time to be asserted
Interrupt Pins – AC Parameters						
Start-up FAULT# Blanking Time	t_{FAULT}	2.5	2.6	2.7	ms	Blanking time, coming out of Reset (Note 2)
FAULT# Pin Overcurrent Masking Time	t_{MASK}	8	10	12	ms	USB PD required masking time
FAULT# Pulse Width	t_{FAULT_ACK}	40	51	65	ms	Minimum time for FAULT# pin to remain set to 'low'

Note 1: This parameter is characterized, not 100% tested.

2: This parameter is ensured by design.

ELECTRICAL CHARACTERISTICS (CONTINUED)

Electrical Specifications: Unless otherwise indicated, $T_A = +25^\circ\text{C}$, V_{IN} or $V_{OUT} = 2.85\text{V}$ to 22V .						
Characteristic	Symbol	Min.	Typ.	Max.	Unit	Conditions
ISEN Pin						
Configurable Current Limit	I_{LIM}	1.59	1.71	1.83	A	$R_{ILIM} = 1.5\text{ k}\Omega$, see calculation in Section 4.2 “Overcurrent Detection” for other I_{LIM} values
Current Limit Accuracy	I_{ACCY}	—	—	± 7	%	See calculation in Section 4.2 “Overcurrent Detection” for I_{LIM} values (Note 2)
Current Limit Resistor	R_{ILIM}	450	—	5000	Ω	
Port Power Switch						
Port Power Switch – DC Parameter						
On Resistance	R_{DS_ON}	—	30	40	m Ω	$V_{IN} = 5\text{V}$, $I_{OUT} = 2\text{A}$
VOUT Leakage Current	I_{LEAK_VOUT}	—	—	5	μA	$V_{IN} = 22\text{V}$, current flowing out the VOUT pin when EN is pulled down, $V_{OUT} = 0\text{V}$
Back-Voltage Fault Protection Threshold	$V_{BV_FAULT_ON}$	20	30	50	mV	$V_{OUT} > V_{IN}$, $V_{IN} > V_{UVLO}$
Back-Voltage FRS Active Threshold	$V_{BV_FAULT_OFF}$	1	20	35	mV	$V_{IN} > V_{UVLO}$; switch turned on when $(V_{OUT} - V_{IN}) < V_{BV_FAULT_OFF}$
Back-Drive Current	I_{BD_1}	—	0	5	μA	$V_{IN} < V_{UVLO}$, $EN = 0\text{V}$, current flowing between VIN and GND when the VOUT pin is connected to a 20V supply (Note 2)
Forward Leakage	I_{BD_2}	—	0	10	μA	$DIR = 1$, $V_{IN} > V_{UVLO}$, $EN = 0\text{V}$, current flowing between VIN and GND when the VOUT pin is connected to a 20V supply (Note 2)
Thermal Shutdown Threshold	T_{TSD}	—	145	—	$^\circ\text{C}$	Die temperature at which the power switch will turn off
Thermal Shutdown Hysteresis	T_{TSD_HYST}	—	20	—	$^\circ\text{C}$	After shutdown, due to T_{TSD} being reached, die temperature drop required before the power switch can be turned on again
Discharge Thermal Shutdown Threshold	T_{DSC_TSD}	—	165	—	$^\circ\text{C}$	Die temperature at which the discharge switch will turn off
Discharge Current	I_{DISCHG}	—	150	—	mA	
Slew Rate	SR	—	20	—	V/ms	

Note 1: This parameter is characterized, not 100% tested.

2: This parameter is ensured by design.

UCS3205

ELECTRICAL CHARACTERISTICS (CONTINUED)

Electrical Specifications: Unless otherwise indicated, $T_A = +25^\circ\text{C}$, V_{IN} or $V_{OUT} = 2.85\text{V}$ to 22V .						
Characteristic	Symbol	Min.	Typ.	Max.	Unit	Conditions
Port Power Switch – AC Parameters						
Minimum Start-up Time	$t_{\text{STRT_EN}}$	60	—	—	ms	Minimum time from $V_{IN_STRT} \geq 3.1\text{V}$ to an EN low-to-high transition
Start-up Current Limit Duration	$t_{\text{STRT_CLD}}$	—	2.5	—	ms	Time from $V_{IN} > V_{UVLO}$ until short circuit and overcurrent comparator are enabled (slew rate control enabled), EN = 1 (Note 1)
Turn-On Delay	$t_{\text{ON_SW}}$	—	0.5	—	ms	Time from the transition of EN from low-to-high until switch is on ($V_{OUT} > 500\text{ mV}$), $C_{OUT} = 10\ \mu\text{F}$, DIR = 1, time from the transition of EN from low-to-high until switch is on ($V_{IN} > 500\text{ mV}$), $C_{IN} = 10\ \mu\text{F}$
Turn-Off Delay	$t_{\text{OFF_SW}}$	—	150	230	μs	Time from the transition of EN from high-to-low until switch is off ($V_{OUT} < V_{IN} - 500\text{ mV}$), $V_{IN} = 5\text{V}$, DIR = 0, DSC = 1, no C_{OUT} , time from the transition of EN from high-to-low until switch is off, ($V_{IN} < V_{OUT} - 500\text{ mV}$), $V_{OUT} = 5\text{V}$, $R_{IN} = 50\ \Omega$, DIR = 1, $50\ \text{k}\Omega$ to GND on VIN, no C_{IN}
Charge Time	t_{CHARGE}	—	1	—	ms	Time from the transition of EN from low-to-high until $V_{OUT} = 19\text{V}$ (95% of $V_{IN} = 20\text{V}$) with $R_{LIM} = 1.5\text{k}\Omega$, $C_{OUT} = 10\ \mu\text{F}$ (Note 1)
Discharge Time	$t_{\text{OUT_DISCHARGE}}$	—	2	—	ms	Time from the transition of EN from high-to-low until $V_{OUT} = 0.8\text{V}$ ($V_{IN} = 20\text{V}$), $C_{OUT} = 10\ \mu\text{F}$, DSC = 1 (Note 1)
OC Turn-Off Time	$t_{\text{OFF_SW_OC}}$	—	10	—	μs	Time from overcurrent event (current less than short-circuit limit) to switch off after t_{MASK} elapses (10 ms), $C_{OUT} = 10\ \mu\text{F}$
Turn-Off Time	$t_{\text{OFF_SW_ERR}}$	—	7	—	μs	Time from TSD, OV, BV, SC event to switch off, no C_{OUT} (Note 1)
VIN or VOUT Output Rise Time	$t_{\text{R_IN_OUT}}$	—	0.8	—	ms	Measured from 10% to 90% of V_{OUT} ($V_{IN} = 20\text{V}$), $C_{OUT} = 10\ \mu\text{F}$ with $R_{LIM} = 1.5\ \text{k}\Omega$, 20 V/ms slew rate, measured from 10% to 90% of V_{IN} ($V_{OUT} = 20\text{V}$), $C_{IN} = 10\ \mu\text{F}$
Short Circuit FAULT# Assertion Time	$t_{\text{SHORT_FAULT}}$	—	20	—	μs	Time from detection of short to port power switch disconnect and FAULT# pin assertion

Note 1: This parameter is characterized, not 100% tested.

2: This parameter is ensured by design.

ELECTRICAL CHARACTERISTICS (CONTINUED)

Electrical Specifications: Unless otherwise indicated, $T_A = +25^\circ\text{C}$, V_{IN} or $V_{OUT} = 2.85\text{V}$ to 22V .

Characteristic	Symbol	Min.	Typ.	Max.	Unit	Conditions
Auto-Retry Time	t_{RETRY}	—	51	—	ms	Time delay before Fault condition check
Maximum Discharge Time	$t_{\text{DISCHARGE}}$	—	50	60	ms	Amount of time discharge internal current source applied (I_{DISCHG}), $\text{DSC} = 1$, internal $50\text{ k}\Omega$ equivalent current source applied when $\text{DSC} = 1$ (Note 1)

Note 1: This parameter is characterized, not 100% tested.

2: This parameter is ensured by design.

UCS3205

2.0 TYPICAL PERFORMANCE CURVES

Note: The graphs and tables provided following this note are a statistical summary based on a limited number of samples and are provided for informational purposes only. The performance characteristics listed herein are not tested or guaranteed. In some graphs or tables, the data presented may be outside the specified operating range (e.g., outside specified power supply range) and therefore outside the warranted range.

Note: Unless otherwise indicated: $T_A = +25^\circ\text{C}$, $V_{IN} = 20\text{V}$, $V_{EN} = 5\text{V}$, $V_{OUT} = 20\text{V}$, $I_{OUT} = 2\text{A}$, $C_{IN} = 100\ \mu\text{F}$, $C_{OUT} = 10\ \mu\text{F}$.

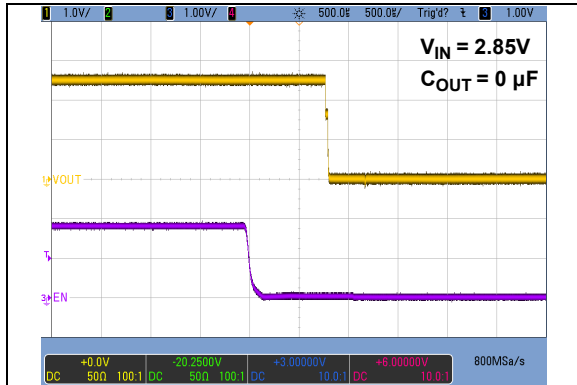

FIGURE 2-1: V_{OUT} Fall Time.

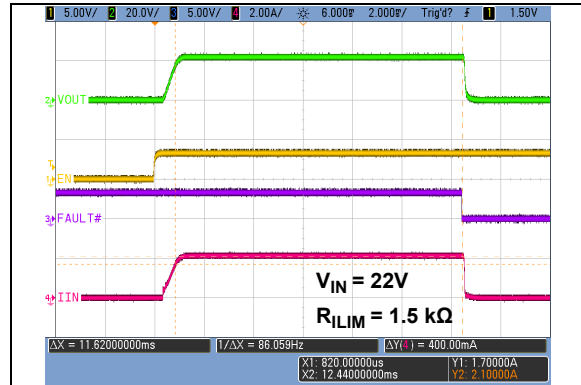

FIGURE 2-4: Overcurrent Fault Response Delay Time.

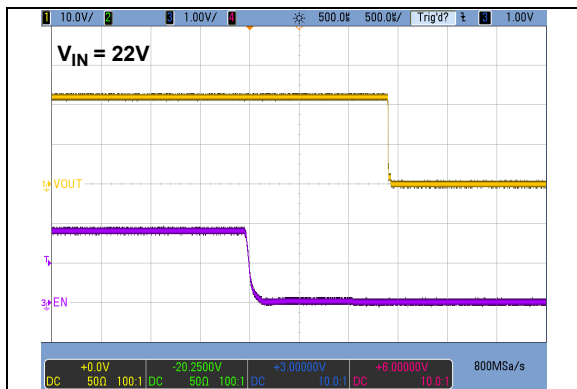

FIGURE 2-2: V_{OUT} Fall Time.

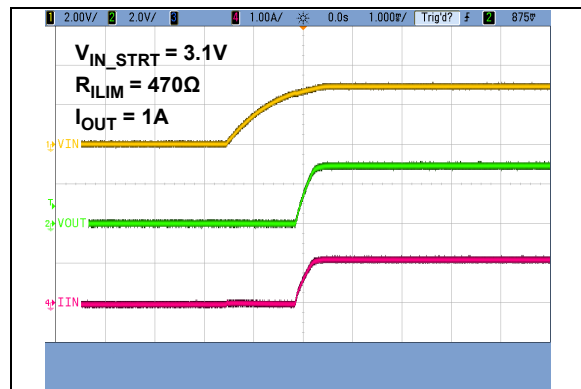

FIGURE 2-5: Soft Start Turn-On.



FIGURE 2-3: Overcurrent Fault Response Delay Time.

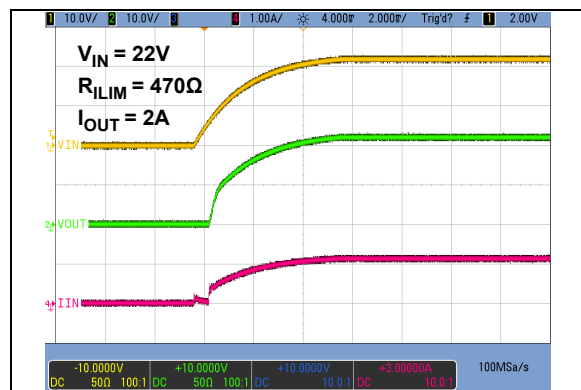

FIGURE 2-6: Soft Start Turn-On.

Note: Unless otherwise indicated: $T_A = +25^\circ\text{C}$, $V_{IN} = 20\text{V}$, $V_{EN} = 5\text{V}$, $V_{OUT} = 20\text{V}$, $I_{OUT} = 2\text{A}$, $C_{IN} = 100\ \mu\text{F}$, $C_{OUT} = 10\ \mu\text{F}$

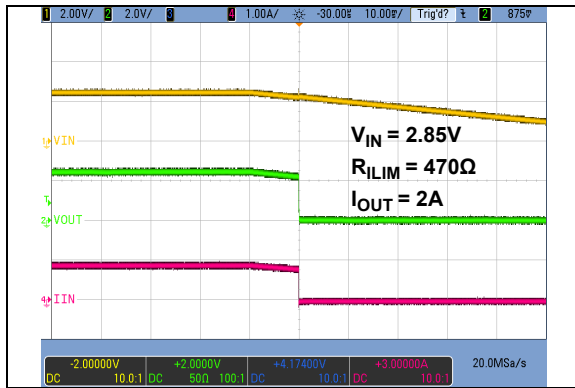

FIGURE 2-7: Soft Start Turn-Off.

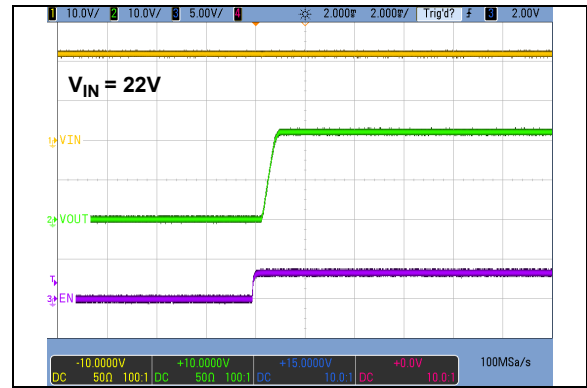

FIGURE 2-10: Turn-On with Enable.

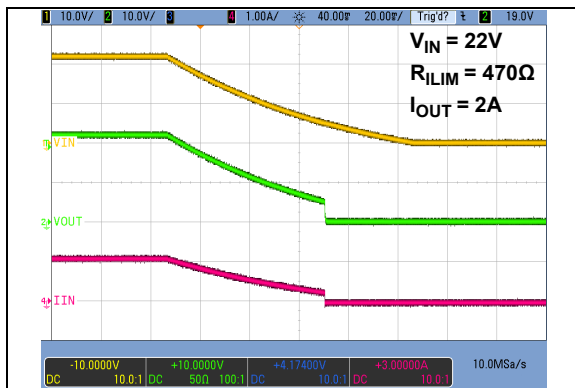

FIGURE 2-8: Soft Start Turn-Off.

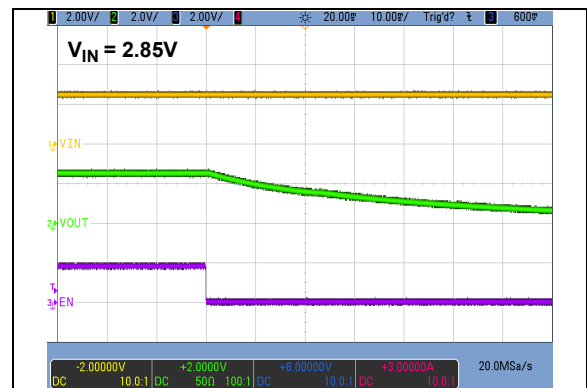

FIGURE 2-11: Turn-Off with Enable.

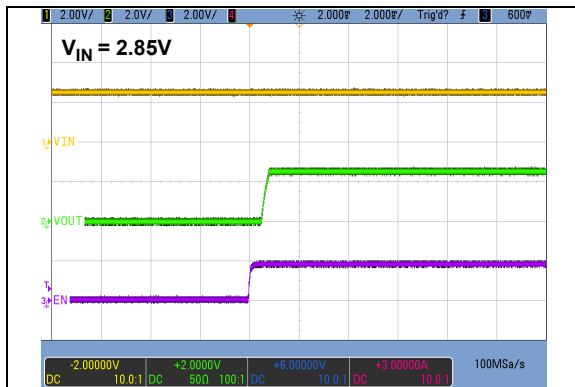

FIGURE 2-9: Turn-On with Enable.

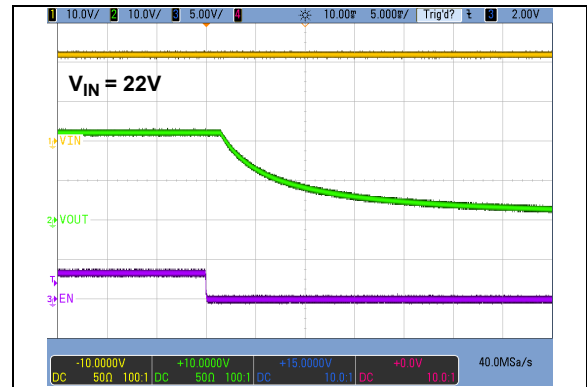

FIGURE 2-12: Turn-Off with Enable.

UCS3205

Note: Unless otherwise indicated: $T_A = +25^\circ\text{C}$, $V_{IN} = 20\text{V}$, $V_{EN} = 5\text{V}$, $V_{OUT} = 20\text{V}$, $I_{OUT} = 2\text{A}$, $C_{IN} = 100\ \mu\text{F}$, $C_{OUT} = 10\ \mu\text{F}$.

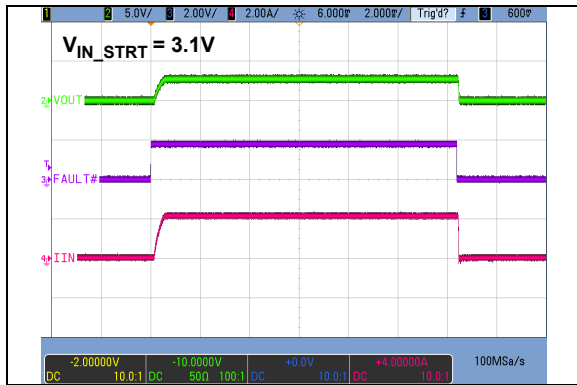

FIGURE 2-13: Turn-On Into 20% Overload.



FIGURE 2-16: Output Recovery from Short Circuit.

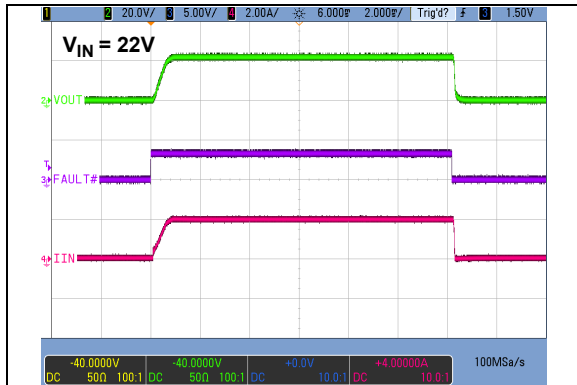

FIGURE 2-14: Turn-On Into 20% Overload.

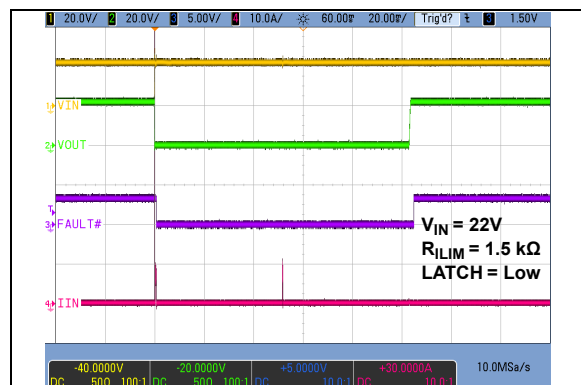

FIGURE 2-17: Output Recovery from Short Circuit.

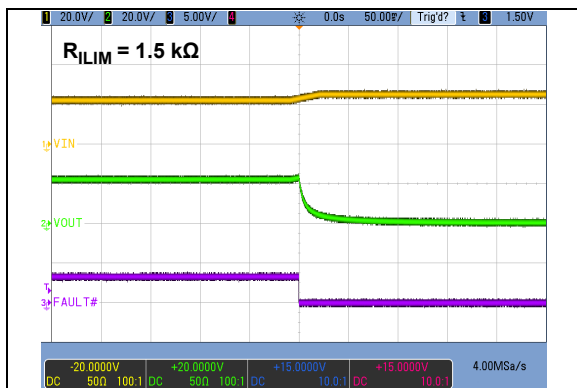

FIGURE 2-15: V_{IN} Overvoltage.



FIGURE 2-18: Turn-On into Short to GND.

Note: Unless otherwise indicated: $T_A = +25^\circ\text{C}$, $V_{IN} = 20\text{V}$, $V_{EN} = 5\text{V}$, $V_{OUT} = 20\text{V}$, $I_{OUT} = 2\text{A}$, $C_{IN} = 100\ \mu\text{F}$, $C_{OUT} = 10\ \mu\text{F}$.

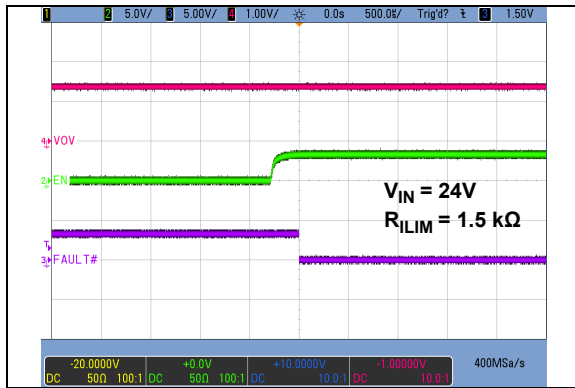

FIGURE 2-19: Turn-On with Overvoltage on V_{IN} .

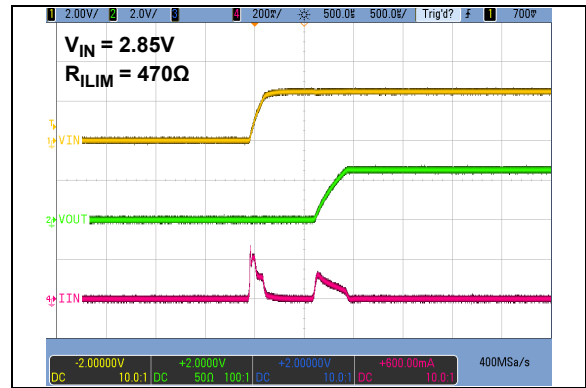

FIGURE 2-22: Inrush Current.

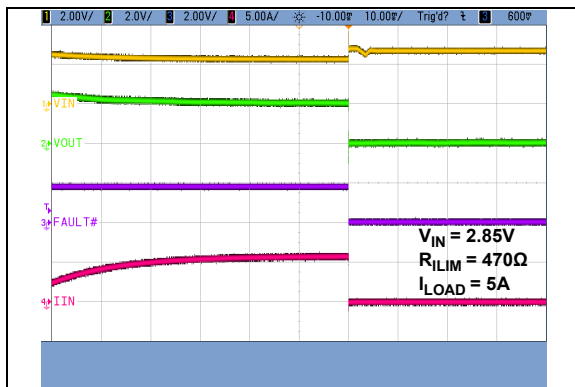

FIGURE 2-20: Current Limit.

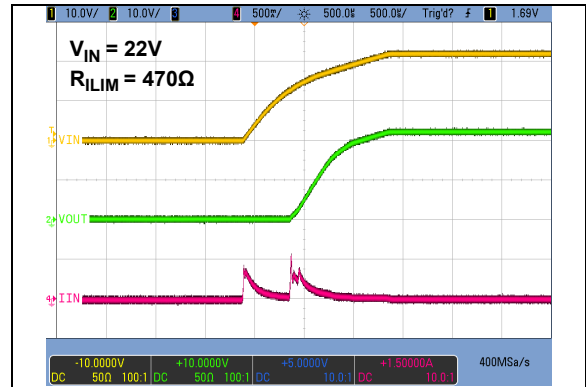

FIGURE 2-23: Inrush Current.

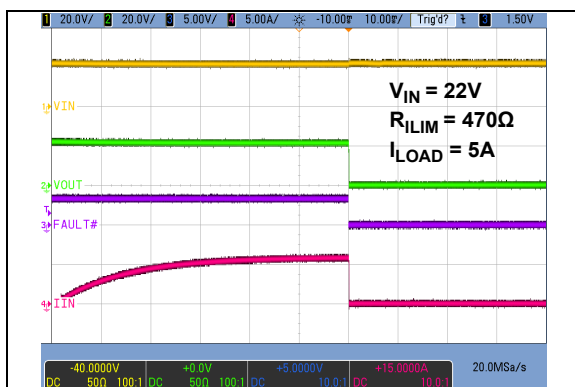

FIGURE 2-21: Current Limit.

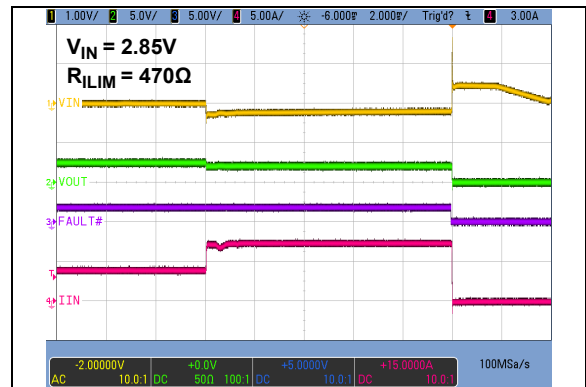

FIGURE 2-24: Current Overload Response.

UCS3205

Note: Unless otherwise indicated: $T_A = +25^\circ\text{C}$, $V_{IN} = 20\text{V}$, $V_{EN} = 5\text{V}$, $V_{OUT} = 20\text{V}$, $I_{OUT} = 2\text{A}$, $C_{IN} = 100\ \mu\text{F}$, $C_{OUT} = 10\ \mu\text{F}$.

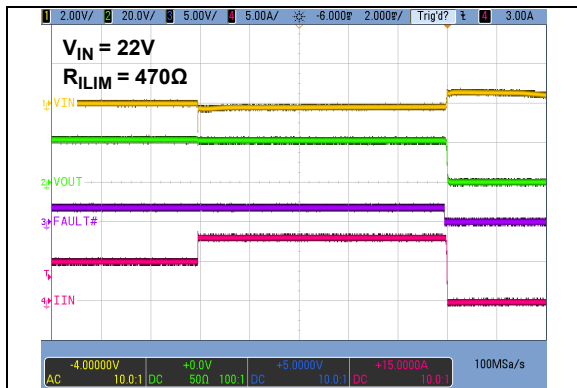

FIGURE 2-25: Current Overload Response.

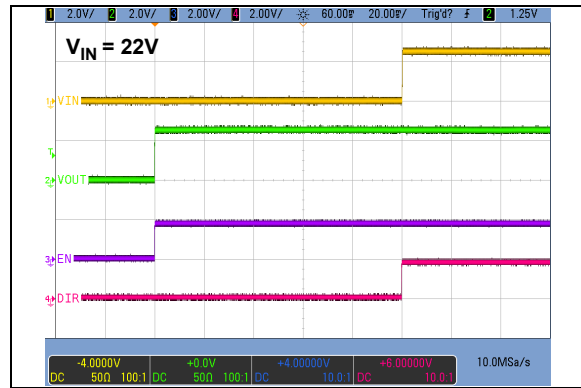

FIGURE 2-28: DIR Functionality.

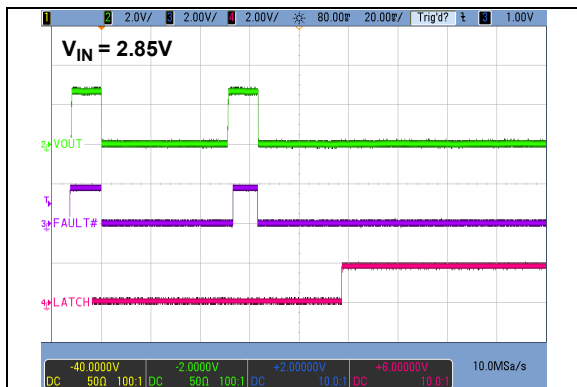

FIGURE 2-26: LATCH Functionality.

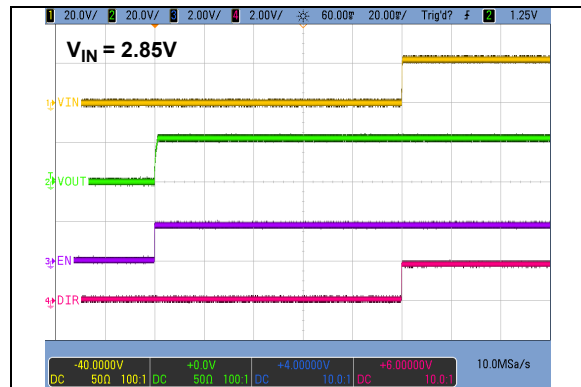

FIGURE 2-29: DIR Functionality.

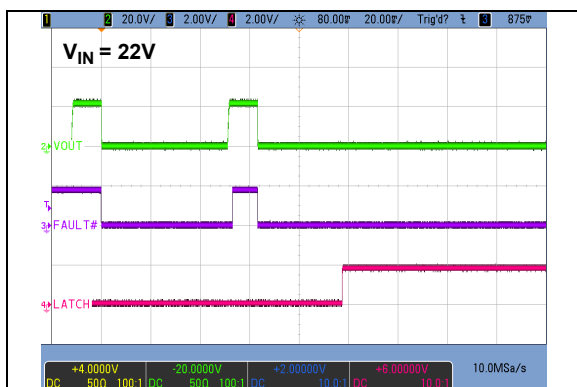

FIGURE 2-27: LATCH Functionality.

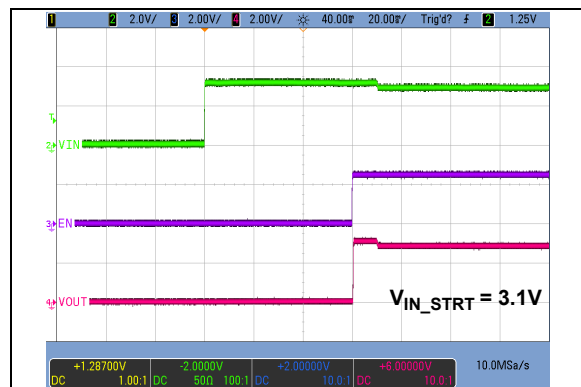

FIGURE 2-30: EN Start-up Time.

3.0 PIN DESCRIPTION

Table 3-1 describes the function of each pin as related to the proposed pinout.

TABLE 3-1: PIN DESCRIPTION TABLE

Pin	Sym	Pin Type	Description
1,15	GND	Ground	Ground for the power supply and the load switch.
2	EN	Digital Input	The power switch is enabled when this pin is pulled high.
3	FRS	Digital Input	Fast Role Swap control input. This pin enables the circuitry for supporting the Fast Role Swap behavior defined in the USB Power Delivery Specification.
4	DIR	Digital Input	Current direction control input. When this pin is high, the reverse current blocking protection is disabled, allowing the current to flow through the switch in the opposite direction.
5	DSC	Digital Input	The triggered output discharge is enabled when this pin is high.
6,7,8,9,10	NC	No Connect	No Connect. These pins MUST be left floating.
11	FAULT#	Open-Drain Output	A Logic Low state indicates a Fault condition. This pin requires an external pull-up resistor.
12	LATCH	Digital Input	If low, the UCS3205 will attempt to restart after a Fault condition (Auto-Retry mode). If high, the device will latch off when a Fault condition is detected, and will not attempt to restart until EN is cycled off and on.
13	ISEN	Analog Output	This pin is a scaled analog output of the current passing through the switch. It requires an external resistor, which sets the current limit threshold. This pin can be connected to external measurement or detection circuitry, such as ADC, comparator or an MCU.
14	VOV	Analog Input	Overvoltage threshold setting pin. Connect to a resistor divider from VIN.
VOUT Exposed Pad, 16,17	VOUT	High Power	Load switch output.
VIN Exposed Pad, 19,20	VIN	High Power	Load switch input.

4.0 FUNCTIONAL DESCRIPTION

The UCS3205 is a single-channel load switch with highly integrated load protection for applications up to 22V.

The device protects the power supply with its configurable current limit feature. The current limit threshold is set with an external resistor. The same pin can be connected to external measurement or detection circuitry, such as an ADC, comparator or MCU, eliminating the need for a shunt in the power path.

The UCS3205 protects the load from being supplied by voltages higher than intended (overvoltage lockout). It also has a thermal shutdown circuit, which will shut the switch off when junction temperature exceeds the limit.

The device implements Fast Role Swap (FRS) capability and reverse current blocking that can be disabled via the DIR pin, allowing it to work as a bidirectional switch depending on the application requirements. **The device's DIR pin is normally grounded for Fast Role Swap applications. The FRS pin is normally grounded for bidirectional current flow applications.**

This device can be programmed to either latch off or retry in the event of a Fault.

4.1 Mode Control

Figure 4-1 shows the UCS3205 state diagram.

4.1.1 RESET MODE

When the UCS3205 is in the Reset state, the device is in its lowest current consumption state. The port power switch is off. The FAULT# pin is not asserted. If the FAULT# pin is asserted prior to entering Reset state, it will be released. When in Reset mode, a low-to-high transition on the EN pin will start the transition of the UCS3205 to its next state. If there are no Faults detected and $t > t_{\text{STRT_CLD}}$ has elapsed, the UCS3205 will transition into the Operating state. If there is an Overvoltage, Back-Voltage, Short-Circuit, Overcurrent, or Thermal Shutdown Fault, the device will transition into the Fault state.

4.1.2 OPERATING MODE

In order for the UCS3205 to enter Operating mode, $V_{\text{IN}}/V_{\text{OUT}}$ must be above $V_{\text{IN_STRT}}/V_{\text{OUT_STRT}}$ for $t_{\text{STRT_EN}}$, before the low-to-high transition on EN, before turning on the switch can take place. Once the switch is on, the V_{IN} voltage can be decreased to 2.85V. Whenever the UCS3205 is in Operating mode, the port power switch will be on. In this case, the FAULT# pin is not asserted. If the FAULT# pin is asserted prior to entering Reset state, it will be released. The UCS3205 cannot be in the Operating state if any of the following conditions exist:

- Overvoltage, Short-Circuit, Overcurrent, Thermal Shutdown or Back-Voltage Fault
- $V_{\text{IN}} < V_{\text{UV_HIGH}}$
- $\text{EN} < V_{\text{IH}}$

When in Operating mode, a high-to-low transition on the EN pin will make the UCS3205 transition into the Reset state. If any Fault conditions occur while in the Operating state, the UCS3205 will automatically transition into the Fault state.

4.1.3 FAULT MODE

The UCS3205 automatically enters the Fault state from the Operating and Retry states when any of the following events are detected:

- An Overvoltage (OV) condition on the VIN pin (see Section 4.4 “VIN Overvoltage Detection”).
- A Short-Circuit (SC) condition (see Section 4.3 “Short-Circuit Detection”).
- An Overcurrent (OC) condition (see Section 4.2 “Overcurrent Detection”).
- Maximum allowable internal die temperature is exceeded – Thermal Shutdown (TSD) (see Section 4.8 “Thermal Shutdown”).
- A Back-Voltage (BV) condition (see Section 4.7 “Back-Voltage Detection”).

The UCS3205 enters the Fault state from the Reset state when there is a low-to-high transition on the EN pin and any of the following events are detected:

- Maximum allowable internal die temperature is exceeded
- Back-Voltage condition,
- Short-Circuit condition on the VOUT pin
- Overcurrent condition on the VOUT pin
- Overvoltage condition on the VIN pin

When the UCS3205 is in Fault mode, the port power switch will be off and the FAULT# pin is asserted.

4.1.4 RETRY MODE

The only way for the UCS3205 to enter the Retry state is from the Fault state and the LATCH pin must be low. When the UCS3205 is in Retry mode, the port power switch will be on and the FAULT# pin is asserted (see Figure 4-5).

4.2 Overcurrent Detection

An OC (Overcurrent) signal is sent to the digital logic when the voltage on the ISEN pin exceeds $V_{SEN} = 0.512V$. The value of the resistor that must be connected to the ISEN pin to set the current limit threshold can be calculated with the following equation:

EQUATION 4-1: OVERCURRENT THRESHOLD

$$R_{ILIM} = \frac{V_{SEN}}{\frac{I_{LIM}}{5000}} = \frac{0.512 \times 5000}{I_{LIM}}$$

For $I_{LIM_MAX} = 5.5A$ (to allow 5A continuous current), the result is $R_{ILIM_MAX} = 470\Omega$.

For $I_{LIM_MIN} = 0.55A$ (to allow 0.5A continuous current), the result is $R_{ILIM_MIN} = 4.7 k\Omega$.

4.3 Short-Circuit Detection

A SC (Short Circuit) signal is sent to the digital logic when the voltage on the ISEN pin exceeds $V_{SEN} = 0.820V$. This corresponds to a current level that is 160% of I_{LIM_MAX} .

The short-circuit current limit threshold can be calculated with the following equation:

EQUATION 4-2: SHORT-CIRCUIT THRESHOLD

$$I_{SC} = \frac{V_{SEN} \times 5000}{R_{ILIM}} = \frac{0.820 \times 5000}{R_{ILIM}}$$

Thus, for $I_{LIM_MAX} = 5.5A$ ($R_{ILIM_MAX} = 470\Omega$), the SC signal will be sent if the current exceeds 8.8A. For $I_{LIM_MIN} = 0.55A$ ($R_{ILIM_MIN} = 4.7 k\Omega$), the SC signal will be sent if the current exceeds 0.88A.

4.4 V_{IN} Overvoltage Detection

An OV (Overvoltage) signal is sent to the digital logic when the voltage on the VOV pin is higher than $V_{REF} = 1.25V$. The overvoltage threshold can be configured by selecting the resistor values of the voltage divider connected to VIN.

4.5 LATCH and DSC Functionality

The LATCH pin controls the retry function. If the LATCH pin is high at the time when a Fault is detected, the digital logic remains in a Fault state until the EN pin is toggled low-to-high and the Fault recovery procedure begins. If the LATCH pin is low, the device enters into Auto-Retry mode by running the Fault recovery procedure every t_{RETRY} , until no Fault condition is detected or until the EN pin is pulled low.

If the DSC pin is high and the switch is off, the UCS3205 discharges the output for the duration of $t_{DISCHARGE}$ unless the DSC pin is pulled low (the DSC pin overrides the discharge timer).

4.6 Fault and Enable Functionality for Combined Mode

Combined mode is implemented on HUBs that have a limited amount of pins in multiple port applications. To alleviate this, both the FAULT and EN pins of the UCS3205 are connected to PRTCTL of the HUB, which is internally pulled up.

The HUB must have enough time to Acknowledge a Fault. The UCS3205 will keep Fault asserted low for the duration of t_{FAULT_ACK} while EN is low (switched off).

4.7 Back-Voltage Detection

Back-voltage detection is only valid when the power switch is on ($EN = 1$). When the power switch is on ($EN = 1$) and the DIR pin is a logic '0', a BV (Back-Voltage) signal is sent to the digital logic when the output voltage (on the VOUT pin) is higher than the input voltage (on the VIN pin) by more than $V_{BV_FAULT_ON}$.

When the DIR pin is a logic '1', back-voltage detection is disabled, so the current through the switch is allowed to flow in either direction; from VIN to VOUT (forward direction) or from VOUT to VIN (reverse direction). The FRS pin of the UCS3205 must be grounded for applications where this functionality is needed. Please note, the UCS3205 does not monitor or limit the current in the reverse direction.

4.8 Thermal Shutdown

The thermal shutdown circuitry sends the Thermal Shutdown (TSD) signal to the digital logic when the die temperature exceeds T_{TSD} . It has a hysteresis of T_{TSD_HYST} .

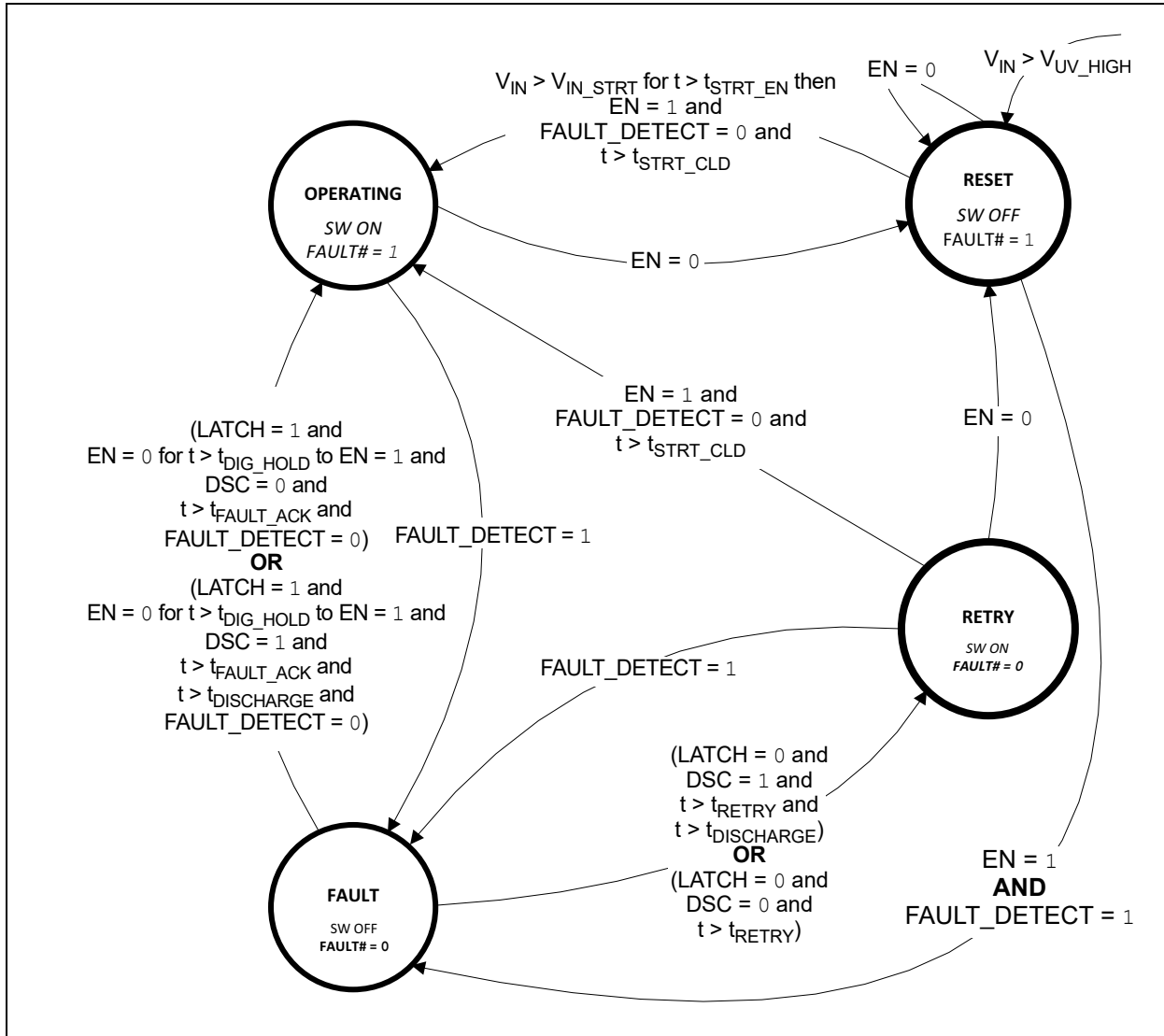

FIGURE 4-1: UCS3205 State Diagram.

4.9 Fast Role Swap (FRS)

The Fast Role Swap circuit enables the application to change the role of sinking current to sourcing current within the allowed time defined by the USB Power Delivery Specification. The FRS circuit is pre-enabled when the FRS pin is pulled high for the duration of t_{FRS_PREARM} and remains in this Ready state as long as the FRS pin remains high. All Fault protections remain active, but the FAULT# pin and associated Fault Handling states are not asserted unless $EN = 1$. Pre-enabling the FRS is valid only in a Reset state ($EN = 0$). A low-to-high FRS transition received while

$EN = 1$ will not affect operation. If $FRS = 1$ and in a Reset state ($EN = 0$), the UCS3205 will then monitor the EN pin for a low-to-high transition. A low-to-high transition on EN will fully enable the FRS circuit and the switch will be turned on in t_{FRS_SWAP} after V_{OUT} drops below V_{IN} . When t_{FRS_SWAP} elapses, the application's V_{OUT} voltage will be above 90% of the V_{IN} voltage. Any high-to-low transitions on the FRS pin are ignored during FRS conditions. A high-to-low transition on EN will turn off the switch and exit FRS. See [Figure 4-2](#), [Figure 4-3](#), and [Figure 4-4](#).

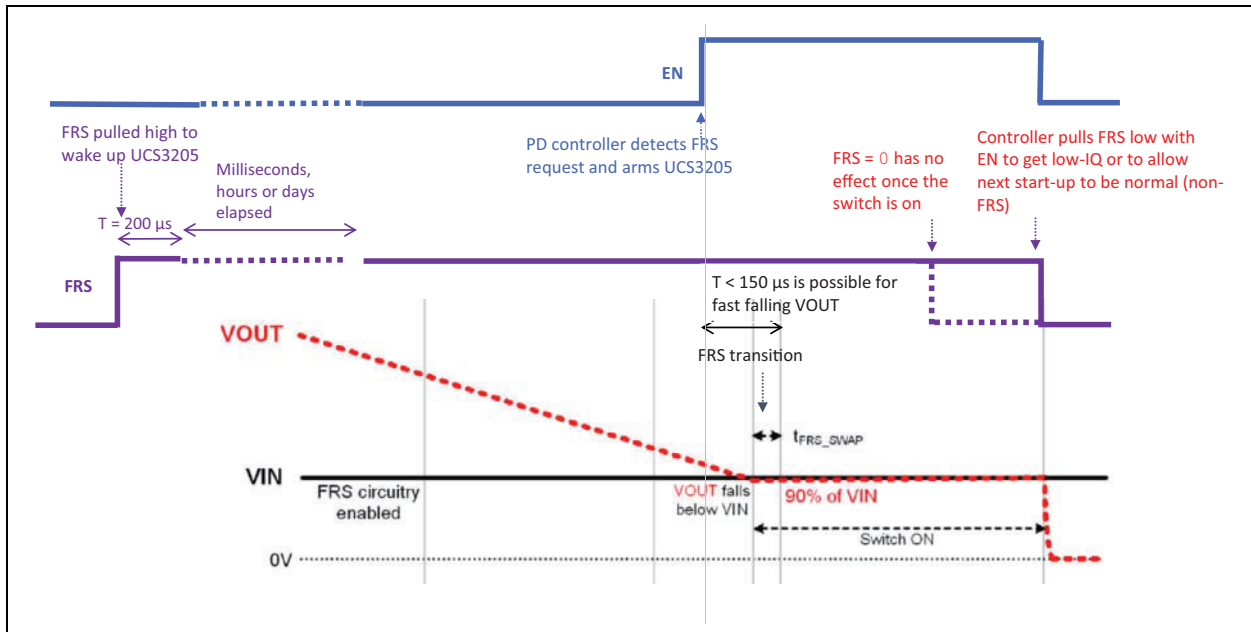

FIGURE 4-2: Fast Role Swap – Nominal Operation.

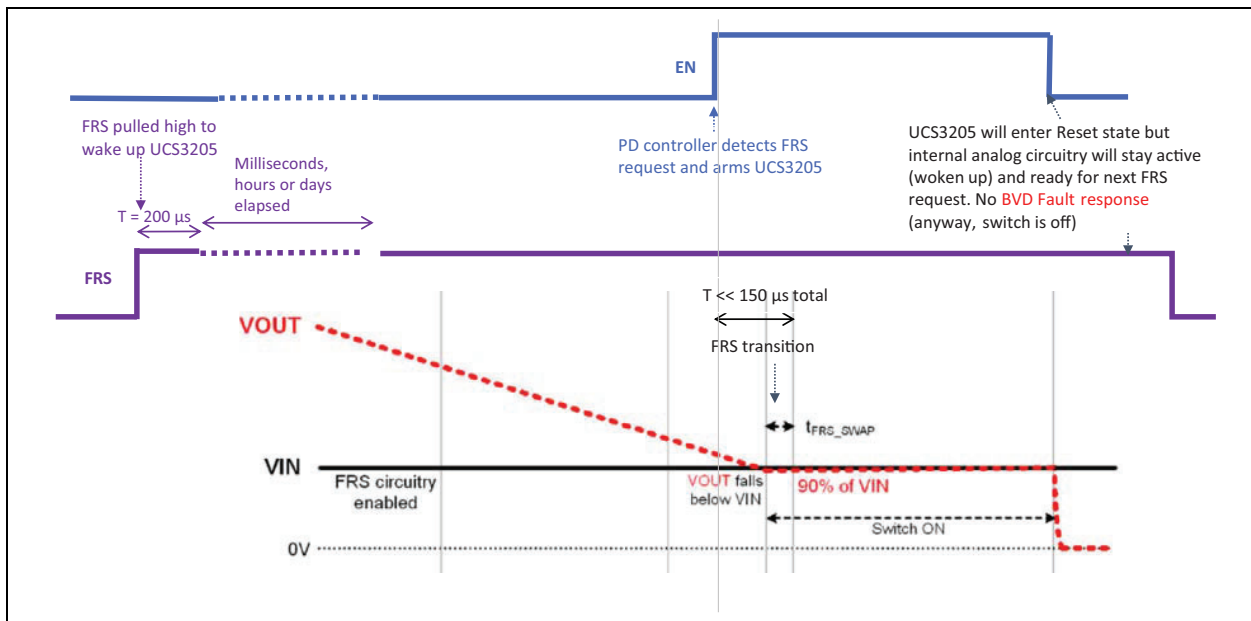

FIGURE 4-3: Fast Role Swap – FRS Circuitry Remains Awake.

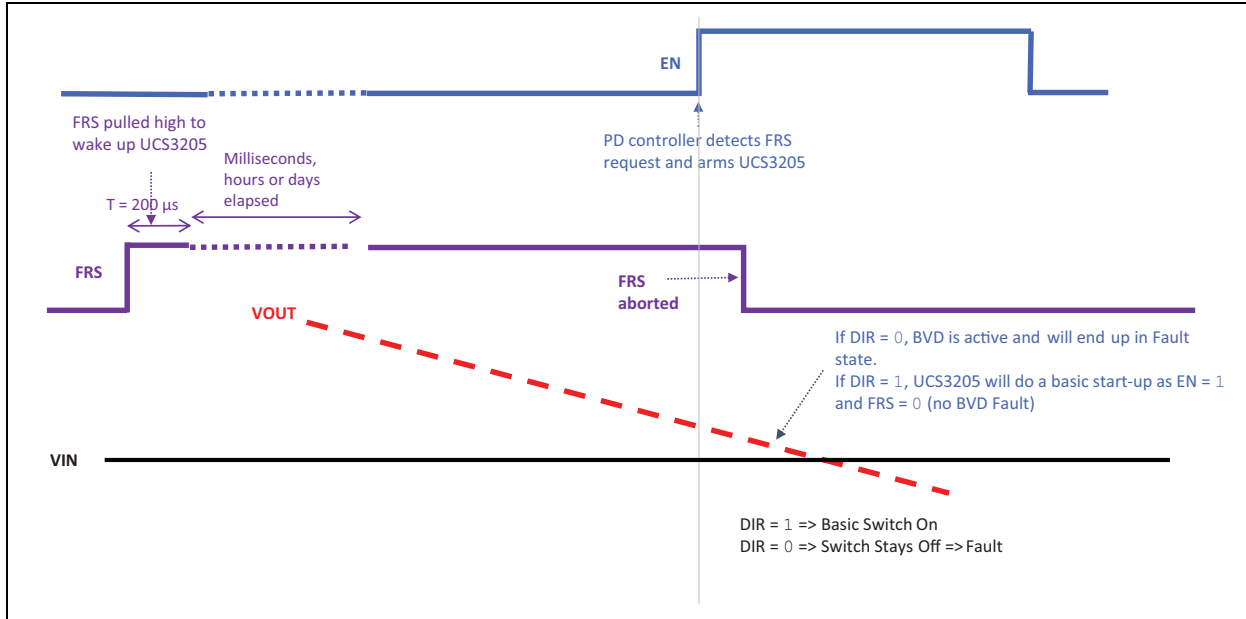

FIGURE 4-4: Fast Role Swap – Aborted.

4.10 Output Discharge

To perform output discharge, the digital logic sends a signal to connect the internal current source between the VOUT pins and ground.

The output discharge can be done only when the switch is off, so only when the EN pin is low or after a Fault condition has been detected.

The DSC pin controls the output discharge behavior according to the [Table 4-1](#).

TABLE 4-1: OUTPUT DISCHARGE CONFIGURATION

DSC Pin State	Output Discharge Behavior
Always low	The output is never discharged.
Always high	Automatic output discharge.
Temporarily high when EN is low, under external circuit control	External triggered output discharge.

4.11 Automatic Output Discharge

The VOUT pin is automatically discharged if the DSC pin is V_{IH} while:

- The EN pin transitions from high-to-low, or
- A Fault condition has been detected.

The automatic output discharge ends when:

- The EN pin transitions from low-to-high, or
- The auto-recovery Fault handling starts, or
- The discharge timer reaches $t_{DISCHARGE}$, or
- The DSC pin transitions from high-to-low, or
- Overtemperature is detected. Overtemperature threshold during discharge is $+170^{\circ}\text{C}$.

4.12 Triggered Output Discharge

To enable the external triggered output discharge, the DSC pin must be normally connected to ground, but pulled high temporarily when the output needs to be discharged.

The output is discharged when the EN pin is pulled low and the DSC pin is pulled high.

The output discharge ends when:

- The DSC pin transitions from high-to-low, or
- The EN pin transitions from low-to-high, or
- The discharge timer reaches $t_{DISCHARGE}$, or
- Overtemperature is detected. Overtemperature threshold during discharge is $+170^{\circ}\text{C}$.

4.13 Fault Handling

A Fault state means that at least one of the following conditions has occurred:

- Short Circuit (SC signal),
- Overcurrent (OC signal),
- Overvoltage (OV signal),
- Thermal Shutdown (TSD signal), or
- Back-Voltage (BV signal) – **Fault DOES NOT apply when the Power Switch is off (EN = 0).**

When the Fault state is detected, the digital logic turns off the switch and asserts the FAULT# pin.

At the time when the Fault is detected, the UCS3205 discharges the output for the duration of $t_{DISCHARGE}$. If the LATCH pin is V_{IH} at the time when the Fault is detected, the digital logic remains in the Fault state until

the EN pin is toggled low-to-high, the Fault conditions are no longer present (OV, TSD, BV) and the Fault recovery procedure begins.

If the LATCH pin is V_{IL} at the time when the Fault is detected, the UCS3205 subsequently enters Auto-Retry mode, where it runs the Fault recovery procedure every t_{RETRY} , until no Fault condition (Overvoltage [OV signal], Thermal Shutdown [TSD signal], Back-Voltage [BV signal if DIR = 0]) is detected or until the EN pin is pulled low.

Figure 4-5 shows the Auto-Retry mode (LATCH pulled low) Fault recovery timing in the case of a short circuit.

At the end of the Fault recovery procedure, if none of the Fault conditions are met, the FAULT# pin is deasserted and the power switch is turned on.

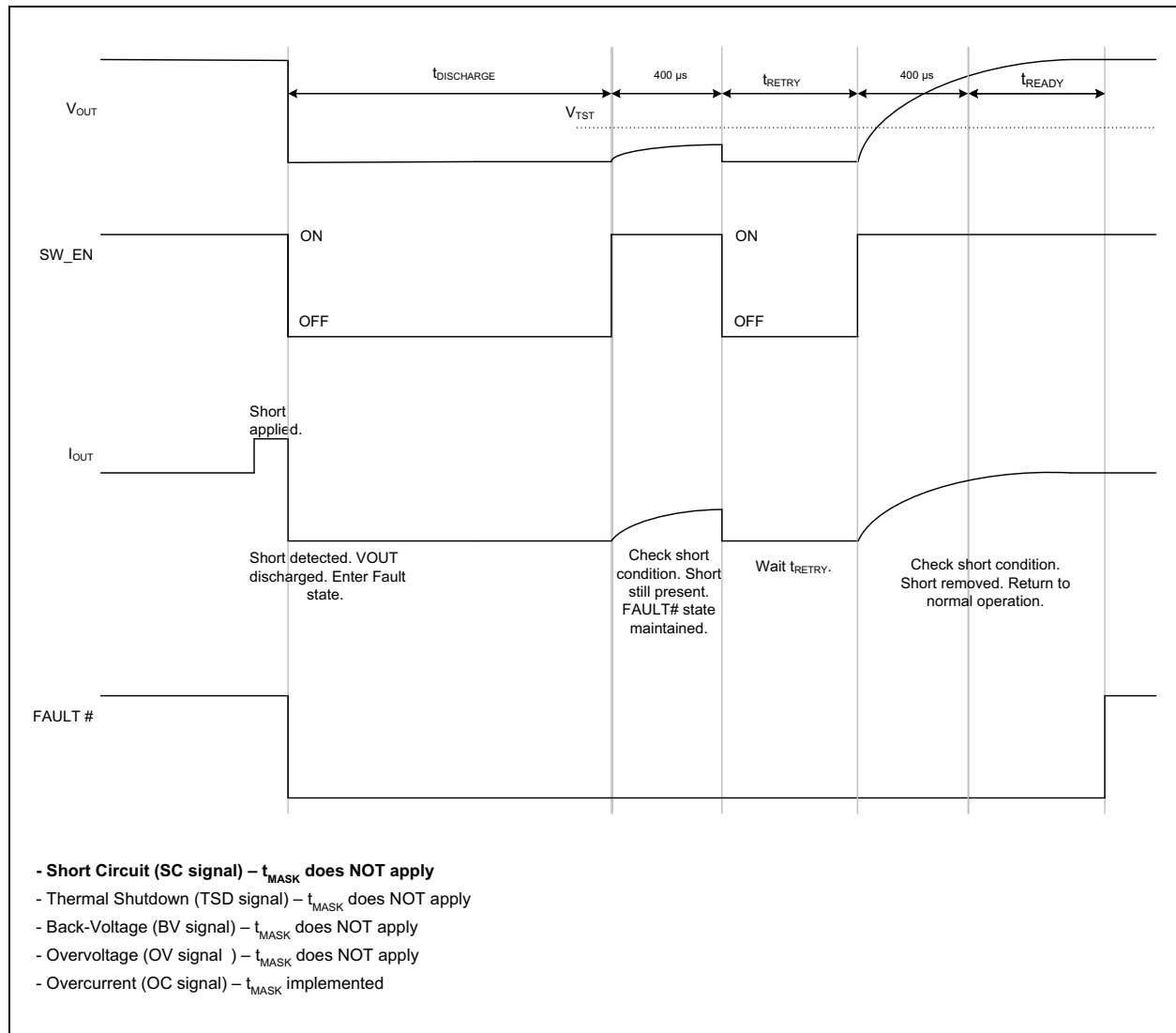

FIGURE 4-5: Auto-Retry Mode Fault Recovery Timing – Short-Circuit Case.

UCS3205

4.14 Typical Application

Figure 4-6 illustrates an example of a typical application of the UCS3205.

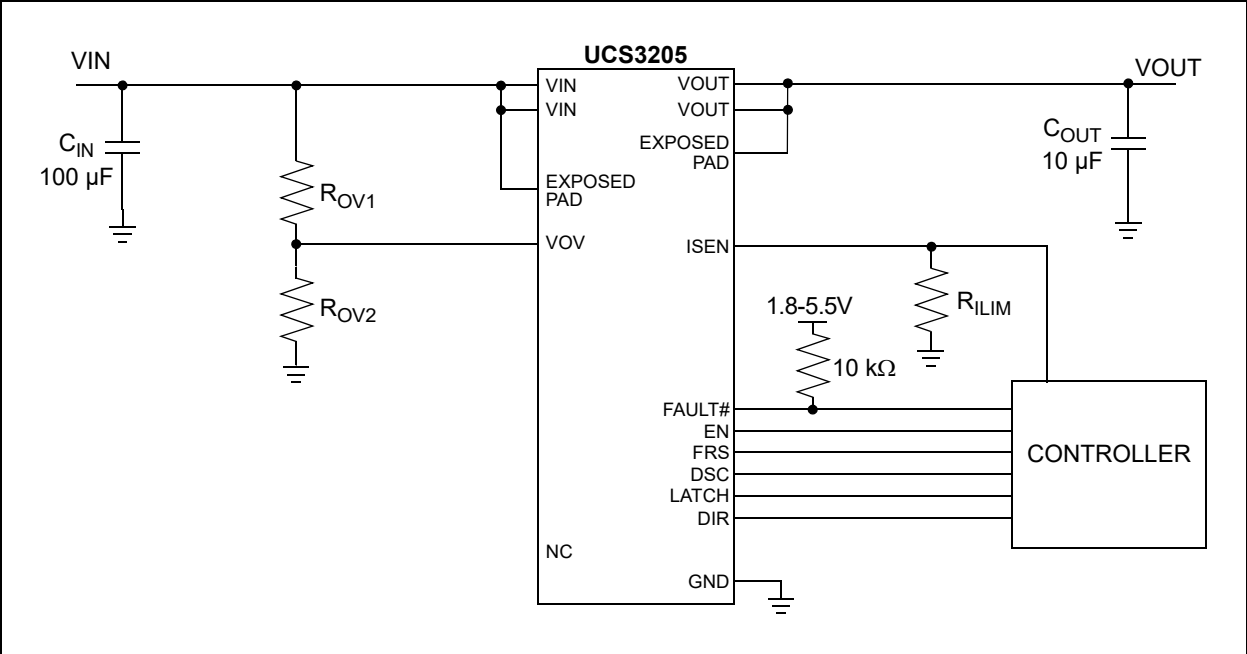
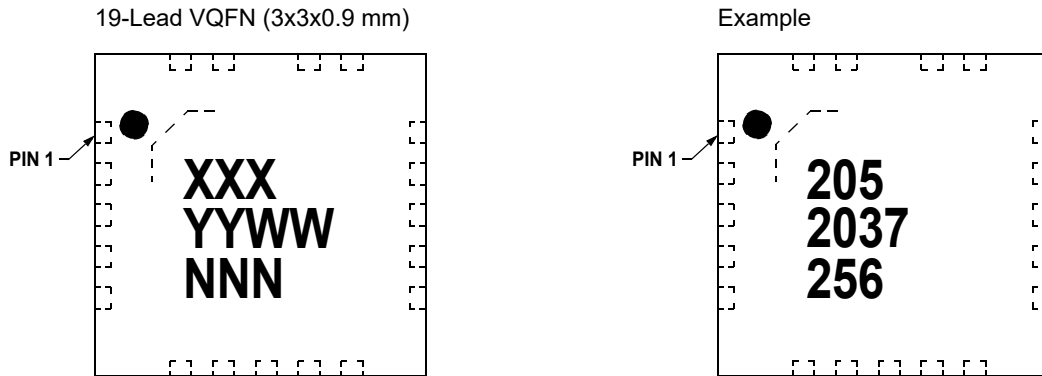

FIGURE 4-6: Typical Application.

5.0 PACKAGING INFORMATION

5.1 Package Marking Information



Legend:	XX...X	Customer-specific information
	Y	Year code (last digit of calendar year)
	YY	Year code (last 2 digits of calendar year)
	WW	Week code (week of January 1 is week '01')
	NNN	Alphanumeric traceability code
	(e3)	Pb-free JEDEC designator for Matte Tin (Sn)
	*	This package is Pb-free. The Pb-free JEDEC designator ((e3)) can be found on the outer packaging for this package.

Note: In the event the full Microchip part number cannot be marked on one line, it will be carried over to the next line, thus limiting the number of available characters for customer-specific information.

UCS3205

19-Lead Very Thin Plastic Quad Flat, No Lead Package (Q8A) - 3x3x0.9 mm Body [VQFN] With Dual Exposed Pads

Note: For the most current package drawings, please see the Microchip Packaging Specification located at <http://www.microchip.com/packaging>

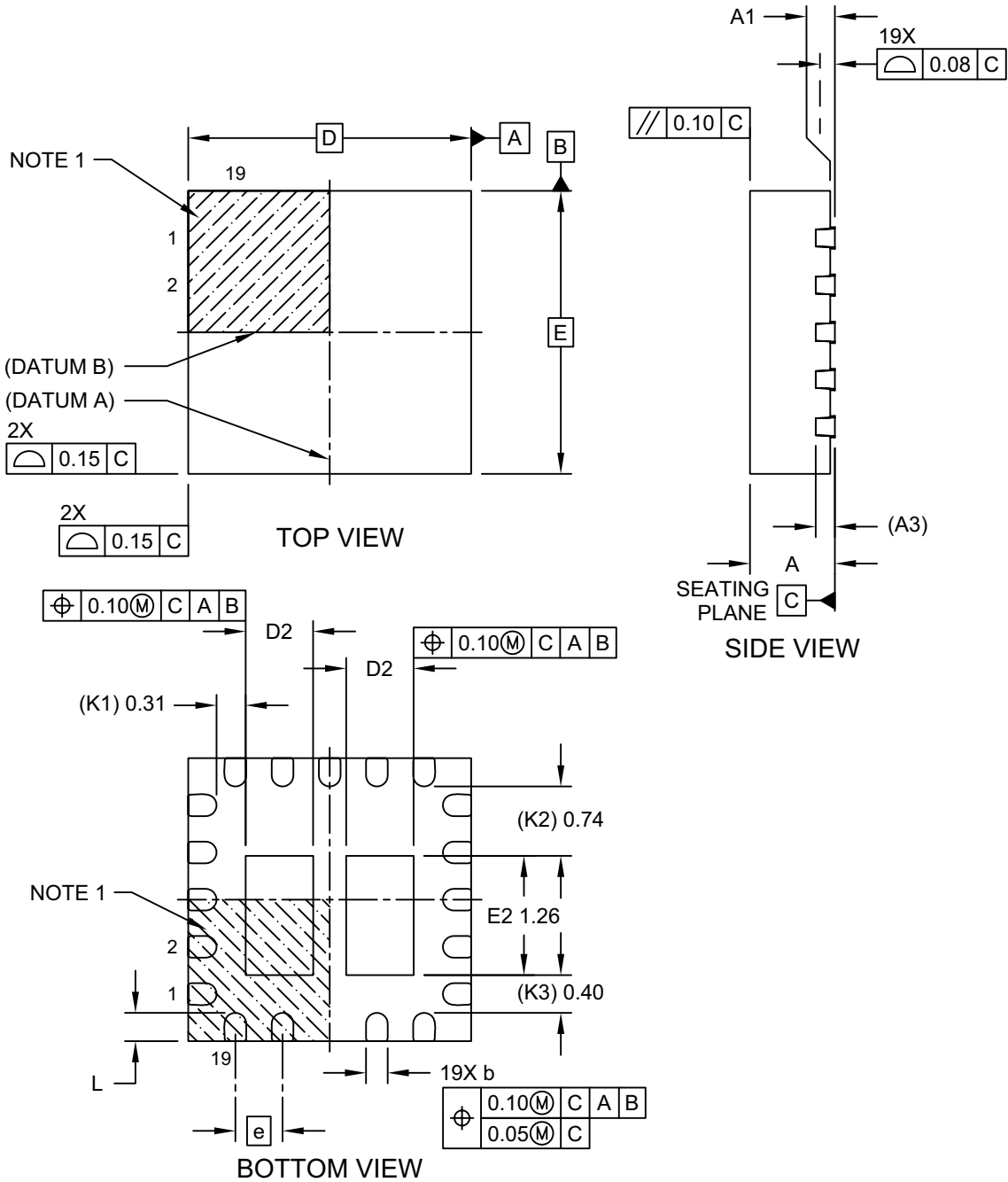

Microchip Technology Drawing C04-1273 Rev A Sheet 1 of 2

19-Lead Very Thin Plastic Quad Flat, No Lead Package (Q8A) - 3x3x0.9 mm Body [VQFN] With Dual Exposed Pads

Note: For the most current package drawings, please see the Microchip Packaging Specification located at <http://www.microchip.com/packaging>

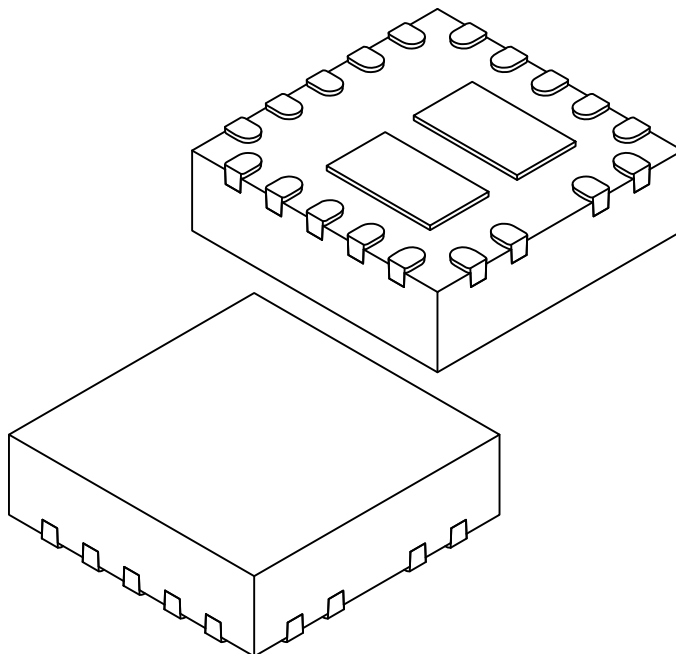

Dimension Limits	Units	MILLIMETERS		
		MIN	NOM	MAX
Number of Terminals	N	19		
Pitch	e	0.50 BSC		
Overall Height	A	-	-	0.90
Standoff	A1	0.00	0.02	0.05
Terminal Thickness	A3	0.203 REF		
Overall Length	D	3.00 BSC		
Exposed Pad Length	D2	0.615	0.715	0.815
Overall Width	E	3.00 BSC		
Exposed Pad Width	E2	1.165	1.265	1.365
Terminal Width	b	0.18	0.23	0.35
Terminal Length	L	0.30	0.30	0.40
Terminal-to-Exposed-Pad	K1	0.31 REF		
Terminal-to-Exposed-Pad	K2	0.74 REF		
Terminal-to-Exposed-Pad	K3	0.40 REF		

Notes:

- Pin 1 visual index feature may vary, but must be located within the hatched area.
- Package is saw singulated
- Dimensioning and tolerancing per ASME Y14.5M
 BSC: Basic Dimension. Theoretically exact value shown without tolerances.
 REF: Reference Dimension, usually without tolerance, for information purposes only.

Microchip Technology Drawing C04-1273 Rev A Sheet 2 of 2

UCS3205

19-Lead Very Thin Plastic Quad Flat, No Lead Package (Q8A) - 3x3x0.9 mm Body [VQFN] With Dual Exposed Pads

Note: For the most current package drawings, please see the Microchip Packaging Specification located at <http://www.microchip.com/packaging>

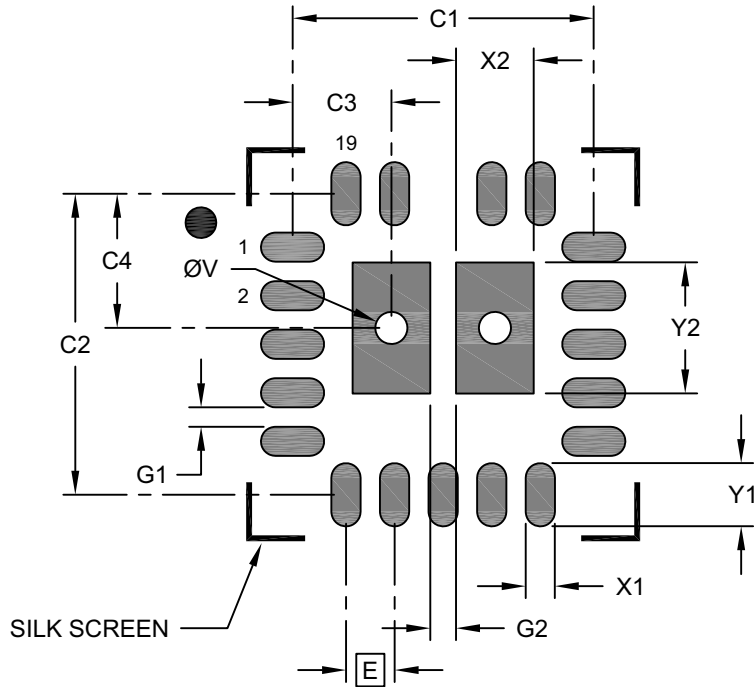

RECOMMENDED LAND PATTERN

Dimension Limits	Units	MILLIMETERS		
		MIN	NOM	MAX
Contact Pitch	E	0.50 BSC		
Optional Center Pad Width	X2			0.80
Optional Center Pad Length	Y2			1.35
Contact Pad Spacing	C1		3.10	
Contact Pad Spacing	C2		3.10	
Contact Pad to Thermal Via (X2)	C3		1.03	
Contact Pad to Thermal Via (X2)	C4		1.38	
Contact Pad Width (X19)	X1			0.30
Contact Pad Length (X19)	Y1			0.65
Contact Pad to Contact Pad (X14)	G1	0.20		
Center Pad to Center Pad	G2	0.27		
Thermal Via Diameter	V		0.33	

Notes:

1. Dimensioning and tolerancing per ASME Y14.5M
BSC: Basic Dimension. Theoretically exact value shown without tolerances.
2. For best soldering results, thermal vias, if used, should be filled or tented to avoid solder loss during reflow process

Microchip Technology Drawing C04-3273 Rev A

APPENDIX A: REVISION HISTORY

Revision A (September 2020)

- Initial release of this document.

UCS3205

NOTES:

PRODUCT IDENTIFICATION SYSTEM

To order or obtain information, e.g., on pricing or delivery, refer to the factory or the listed sales office.

<u>PART NO.</u>	<u>X</u> ⁽¹⁾	<u>X</u>	<u>/XXX</u>	<u>/XXX</u>	Examples:
Device	Tape and Reel Option	Temperature Range	Package	Qualification	
Device:	UCS3205: 5A, 22V Bidirectional Load Switch with Fast Role Swap				a) UCS3205T-E/Q8A: Tape and Reel, Extended Temperature, 19-Lead VQFN Package
Tape and Reel Option:	Blank = Standard Packaging (tube or tray) T = Tape and Reel ⁽¹⁾				b) UCS3205-E/Q8A: Extended Temperature, 19-Lead VQFN Package
Temperature Range:	E = -40°C to +125°C (Extended)				c) UCS3205T-E/Q8AVAO: Tape and Reel, Extended Temperature, 19-Lead VQFN Package, Automotive Qualified
Package:	Q8A = Plastic Quad Flat, No Lead Package, 3 x 3 x 0.9 mm Body with Dual Exposed Pads, 19-Lead VQFN				d) UCS3205-E/Q8AVAO: Extended Temperature, 19-Lead VQFN Package, Automotive Qualified
Qualification:	Blank = Standard Qualification VAO = AEC-Q100 Automotive Qualification				Note 1: Tape and Reel identifier only appears in the catalog part number description. This identifier is used for ordering purposes and is not printed on the device package. Check with your Microchip Sales Office for package availability with the Tape and Reel option.

UCS3205

NOTES:

Note the following details of the code protection feature on Microchip devices:

- Microchip products meet the specifications contained in their particular Microchip Data Sheet.
- Microchip believes that its family of products is secure when used in the intended manner and under normal conditions.
- There are dishonest and possibly illegal methods being used in attempts to breach the code protection features of the Microchip devices. We believe that these methods require using the Microchip products in a manner outside the operating specifications contained in Microchip's Data Sheets. Attempts to breach these code protection features, most likely, cannot be accomplished without violating Microchip's intellectual property rights.
- Microchip is willing to work with any customer who is concerned about the integrity of its code.
- Neither Microchip nor any other semiconductor manufacturer can guarantee the security of its code. Code protection does not mean that we are guaranteeing the product is "unbreakable." Code protection is constantly evolving. We at Microchip are committed to continuously improving the code protection features of our products. Attempts to break Microchip's code protection feature may be a violation of the Digital Millennium Copyright Act. If such acts allow unauthorized access to your software or other copyrighted work, you may have a right to sue for relief under that Act.

Information contained in this publication is provided for the sole purpose of designing with and using Microchip products. Information regarding device applications and the like is provided only for your convenience and may be superseded by updates. It is your responsibility to ensure that your application meets with your specifications.

THIS INFORMATION IS PROVIDED BY MICROCHIP "AS IS". MICROCHIP MAKES NO REPRESENTATIONS OR WARRANTIES OF ANY KIND WHETHER EXPRESS OR IMPLIED, WRITTEN OR ORAL, STATUTORY OR OTHERWISE, RELATED TO THE INFORMATION INCLUDING BUT NOT LIMITED TO ANY IMPLIED WARRANTIES OF NON-INFRINGEMENT, MERCHANTABILITY, AND FITNESS FOR A PARTICULAR PURPOSE OR WARRANTIES RELATED TO ITS CONDITION, QUALITY, OR PERFORMANCE.

IN NO EVENT WILL MICROCHIP BE LIABLE FOR ANY INDIRECT, SPECIAL, PUNITIVE, INCIDENTAL OR CONSEQUENTIAL LOSS, DAMAGE, COST OR EXPENSE OF ANY KIND WHATSOEVER RELATED TO THE INFORMATION OR ITS USE, HOWEVER CAUSED, EVEN IF MICROCHIP HAS BEEN ADVISED OF THE POSSIBILITY OR THE DAMAGES ARE FORESEEABLE. TO THE FULLEST EXTENT ALLOWED BY LAW, MICROCHIP'S TOTAL LIABILITY ON ALL CLAIMS IN ANY WAY RELATED TO THE INFORMATION OR ITS USE WILL NOT EXCEED THE AMOUNT OF FEES, IF ANY, THAT YOU HAVE PAID DIRECTLY TO MICROCHIP FOR THE INFORMATION. Use of Microchip devices in life support and/or safety applications is entirely at the buyer's risk, and the buyer agrees to defend, indemnify and hold harmless Microchip from any and all damages, claims, suits, or expenses resulting from such use. No licenses are conveyed, implicitly or otherwise, under any Microchip intellectual property rights unless otherwise stated.

Trademarks

The Microchip name and logo, the Microchip logo, Adaptec, AnyRate, AVR, AVR logo, AVR Freaks, BesTime, BitCloud, chipKIT, chipKIT logo, CryptoMemory, CryptoRF, dsPIC, FlashFlex, flexPWR, HELDO, IGLoo, JukeBlox, KeeLoq, Klear, LANCheck, LinkMD, maXStylus, maXTouch, MediaLB, megaAVR, Microsemi, Microsemi logo, MOST, MOST logo, MPLAB, OptoLyzer, PackTime, PIC, picoPower, PICSTART, PIC32 logo, PolarFire, Prochip Designer, QTouch, SAM-BA, SenGenuity, SpyNIC, SST, SST Logo, SuperFlash, Symmetricom, SyncServer, Tachyon, TempTracker, TimeSource, tinyAVR, UNI/O, Vectron, and XMEGA are registered trademarks of Microchip Technology Incorporated in the U.S.A. and other countries.

APT, ClockWorks, The Embedded Control Solutions Company, EtherSynch, FlashTec, Hyper Speed Control, HyperLight Load, IntelliMOS, Libero, motorBench, mTouch, Powermite 3, Precision Edge, ProASIC, ProASIC Plus, ProASIC Plus logo, Quiet-Wire, SmartFusion, SyncWorld, Temux, TimeCesium, TimeHub, TimePictra, TimeProvider, Vite, WinPath, and ZL are registered trademarks of Microchip Technology Incorporated in the U.S.A.

Adjacent Key Suppression, AKS, Analog-for-the-Digital Age, Any Capacitor, AnyIn, AnyOut, BlueSky, BodyCom, CodeGuard, CryptoAuthentication, CryptoAutomotive, CryptoCompanion, CryptoController, dsPICDEM, dsPICDEM.net, Dynamic Average Matching, DAM, ECAN, EtherGREEN, In-Circuit Serial Programming, ICSP, INICnet, Inter-Chip Connectivity, JitterBlocker, KlearNet, KlearNet logo, memBrain, MIndi, MiWi, MPASM, MPF, MPLAB Certified logo, MPLIB, MPLINK, MultiTRAK, NetDetach, Omniscient Code Generation, PICDEM, PICDEM.net, PICkit, PICtail, PowerSmart, PureSilicon, QMatrix, REAL ICE, Ripple Blocker, SAM-ICE, Serial Quad I/O, SMART-I.S., SQI, SuperSwitcher, SuperSwitcher II, Total Endurance, TSHARC, USBCheck, VariSense, ViewSpan, WiperLock, Wireless DNA, and ZENA are trademarks of Microchip Technology Incorporated in the U.S.A. and other countries.

SQTP is a service mark of Microchip Technology Incorporated in the U.S.A.

The Adaptec logo, Frequency on Demand, Silicon Storage Technology, and Symmcom are registered trademarks of Microchip Technology Inc. in other countries.

GestIC is a registered trademark of Microchip Technology Germany II GmbH & Co. KG, a subsidiary of Microchip Technology Inc., in other countries.

All other trademarks mentioned herein are property of their respective companies.

© 2020, Microchip Technology Incorporated, All Rights Reserved.

ISBN: 978-1-5224-6860-8

For information regarding Microchip's Quality Management Systems, please visit www.microchip.com/quality.



MICROCHIP

Worldwide Sales and Service

AMERICAS

Corporate Office
2355 West Chandler Blvd.
Chandler, AZ 85224-6199
Tel: 480-792-7200
Fax: 480-792-7277
Technical Support:
<http://www.microchip.com/support>
Web Address:
www.microchip.com

Atlanta

Duluth, GA
Tel: 678-957-9614
Fax: 678-957-1455

Austin, TX

Tel: 512-257-3370

Boston

Westborough, MA
Tel: 774-760-0087
Fax: 774-760-0088

Chicago

Itasca, IL
Tel: 630-285-0071
Fax: 630-285-0075

Dallas

Addison, TX
Tel: 972-818-7423
Fax: 972-818-2924

Detroit

Novi, MI
Tel: 248-848-4000

Houston, TX

Tel: 281-894-5983

Indianapolis

Noblesville, IN
Tel: 317-773-8323
Fax: 317-773-5453
Tel: 317-536-2380

Los Angeles

Mission Viejo, CA
Tel: 949-462-9523
Fax: 949-462-9608
Tel: 951-273-7800

Raleigh, NC

Tel: 919-844-7510

New York, NY

Tel: 631-435-6000

San Jose, CA

Tel: 408-735-9110
Tel: 408-436-4270

Canada - Toronto

Tel: 905-695-1980
Fax: 905-695-2078

ASIA/PACIFIC

Australia - Sydney
Tel: 61-2-9868-6733

China - Beijing
Tel: 86-10-8569-7000

China - Chengdu
Tel: 86-28-8665-5511

China - Chongqing
Tel: 86-23-8980-9588

China - Dongguan
Tel: 86-769-8702-9880

China - Guangzhou
Tel: 86-20-8755-8029

China - Hangzhou
Tel: 86-571-8792-8115

China - Hong Kong SAR
Tel: 852-2943-5100

China - Nanjing
Tel: 86-25-8473-2460

China - Qingdao
Tel: 86-532-8502-7355

China - Shanghai
Tel: 86-21-3326-8000

China - Shenyang
Tel: 86-24-2334-2829

China - Shenzhen
Tel: 86-755-8864-2200

China - Suzhou
Tel: 86-186-6233-1526

China - Wuhan
Tel: 86-27-5980-5300

China - Xian
Tel: 86-29-8833-7252

China - Xiamen
Tel: 86-592-2388138

China - Zhuhai
Tel: 86-756-3210040

ASIA/PACIFIC

India - Bangalore
Tel: 91-80-3090-4444

India - New Delhi
Tel: 91-11-4160-8631

India - Pune
Tel: 91-20-4121-0141

Japan - Osaka
Tel: 81-6-6152-7160

Japan - Tokyo
Tel: 81-3-6880-3770

Korea - Daegu
Tel: 82-53-744-4301

Korea - Seoul
Tel: 82-2-554-7200

Malaysia - Kuala Lumpur
Tel: 60-3-7651-7906

Malaysia - Penang
Tel: 60-4-227-8870

Philippines - Manila
Tel: 63-2-634-9065

Singapore
Tel: 65-6334-8870

Taiwan - Hsin Chu
Tel: 886-3-577-8366

Taiwan - Kaohsiung
Tel: 886-7-213-7830

Taiwan - Taipei
Tel: 886-2-2508-8600

Thailand - Bangkok
Tel: 66-2-694-1351

Vietnam - Ho Chi Minh
Tel: 84-28-5448-2100

EUROPE

Austria - Wels
Tel: 43-7242-2244-39
Fax: 43-7242-2244-393

Denmark - Copenhagen
Tel: 45-4485-5910
Fax: 45-4485-2829

Finland - Espoo
Tel: 358-9-4520-820

France - Paris
Tel: 33-1-69-53-63-20
Fax: 33-1-69-30-90-79

Germany - Garching
Tel: 49-8931-9700

Germany - Haan
Tel: 49-2129-3766400

Germany - Heilbronn
Tel: 49-7131-72400

Germany - Karlsruhe
Tel: 49-721-625370

Germany - Munich
Tel: 49-89-627-144-0
Fax: 49-89-627-144-44

Germany - Rosenheim
Tel: 49-8031-354-560

Israel - Ra'anana
Tel: 972-9-744-7705

Italy - Milan
Tel: 39-0331-742611
Fax: 39-0331-466781

Italy - Padova
Tel: 39-049-7625286

Netherlands - Drunen
Tel: 31-416-690399
Fax: 31-416-690340

Norway - Trondheim
Tel: 47-7288-4388

Poland - Warsaw
Tel: 48-22-3325737

Romania - Bucharest
Tel: 40-21-407-87-50

Spain - Madrid
Tel: 34-91-708-08-90
Fax: 34-91-708-08-91

Sweden - Gothenberg
Tel: 46-31-704-60-40

Sweden - Stockholm
Tel: 46-8-5090-4654

UK - Wokingham
Tel: 44-118-921-5800
Fax: 44-118-921-5820