

ALVIUM MIPI CSI-2 CAMERAS

Adapter Board for Toradex Ixora Carrier Board User Guide

V1.0.3

This document at a glance



Read this document carefully

Learn to use adapter boards in the most safe and efficient way and avoid damage to your embedded system.

Shipping contents

The delivery consists of:

- Adapter board for Toradex Ixora Carrier Board
- Flat flexible cable (FCC) to connect the adapter board to the embedded board



Flexible printed circuit (FPC) cable is not included

The FPC cable to connect the adapter board to the camera is not included.

What else do you need?



Technical information and ordering of Allied Vision products

- For all information about Alvium CSI-2 cameras and accessories, see www.alliedvision.com/en/support/technical-documentation/alvium-csi-2-documentation.
- Please contact your Allied Vision Sales representative for ordering and for additional information on hardware options for Alvium cameras.



Technical information on Toradex embedded boards

For information on Toradex embedded boards, see www.toradex.com.

Contact us

Website, email

General

www.alliedvision.com/en/contact
info@alliedvision.com

Distribution partners

www.alliedvision.com/en/avt-locations/avt-distributors

Support

www.alliedvision.com/en/support
www.alliedvision.com/en/about-us/contact-us/technical-support-repair-/-rma

Offices

Europe, Middle East, and Africa (Headquarters)

Allied Vision Technologies GmbH
Taschenweg 2a
07646 Stadtroda, Germany
T// +49 36428 677-0 (Reception)
T// +49 36428 677-230 (Sales)
F// +49 36428 677-28

Asia-Pacific

China

Allied Vision Technologies
(Shanghai) Co., Ltd.
2-2109 Hongwell Int. Plaza
1602# ZhongShanXi Road
Shanghai 200235, China
T// +86 21 64861133

Singapore

Allied Vision Technologies Asia Pte. Ltd
82 Playfair Rd, #07-02 D'Lithium
Singapore 368001
T// +65 6634 9027

North, Central, and South America

Canada

Allied Vision Technologies Canada Inc.
300 – 4621 Canada Way
Burnaby, BC V5G 4X8, Canada
T// +1 604 875 8855

USA

Allied Vision Technologies, Inc.
102 Pickering Way- Suite 502
Exton, PA 19341, USA
Toll-free// +1-877-USA-1394
T// +1 978 225 2030

Contents

This document at a glance	2
Shipping contents	2
What else do you need?	2
Contact us	3
Document history and conventions	6
Document history	7
Conventions used in this user guide	7
Typographical styles	7
Symbols and notes	7
Component naming	9
Compliance, safety, and intended use	10
Compliance notifications	11
Intended use	11
Copyright and trademarks	11
Your safety	12
Handling hot adapter boards	12
Product safety	12
Embedded systems	12
Electrical connections	12
Electrostatic discharge (ESD)	12
Camera power	13
FPC connectors	13
I/O connections	15
Specifications	16
Specifications	17
PCB and PCBA number	17
Dimensions and PCB layout	18
Electronic schematics	19
Camera power	21
I/O connections	21
Using the adapter board	22
Embedded system accessories	23
Connecting FPC cables to Hirose FPC connectors	23
Installing adapter boards	25
Connecting the FFC	26
Connecting the embedded board	27
Connecting the camera	27

Connecting USB power.....	28
Connecting the I/Os.....	29

Document history and conventions



This chapter includes:

Document history	7
Conventions used in this user guide.....	7
Component naming	8

Document history

Version	Date	Remarks
V1.0.3	2021-Dec-01	<ul style="list-style-type: none"> Added notes about housings to avoid injuries by heat. Added contents about PCB and PCBA number on page 17. Applied editorial changes.
V1.0.2	2020-Sep-02	Added information on I/O specifications in I/O connections on page 21 and on connecting I/Os in Connecting the I/Os on page 29.
V1.0.1	2020-May-06	<ul style="list-style-type: none"> Added the diameter for the mounting holes of the adapter board. Applied editorial changes.
V1.0.0	2019-Nov-21	Release version

Table 1: Document history

Conventions used in this user guide

To give this user guide an easily understood layout and to emphasize important information, the following typographical styles and symbols are used:

Typographical styles

Style	Function
Emphasis	Highlighting important things
Web links and references	Links to webpages and internal cross references

Table 2: Typographical styles

Symbols and notes



CAUTION

Risk of burns

Precautions are described



NOTICE

Material damage

Precautions are described.

Practical tip

Additional information helps to understand or ease handling the camera and components.

Additional information

Web link or reference to an external source with more information is shown.

Component naming

Components described in this user guide are not defined by common standards. Therefore, naming must be accurate to avoid misconceptions. Because naming is lengthy, reading is difficult. Simplified terms are used in this document.

Long version	Short version used in this document	Alvium CSI-2 Cameras Safety and Usage Instructions
Adapter Board for Toradex Ixora Carrier Board	adapter for Toradex Ixora	Not applicable
MIPI CSI-2 ¹ adapter board	adapter board	embedded board adapter
MIPI CSI-2 FFC (flat flexible cable)	FFC	Not applicable
MIPI CSI-2 FPC (flexible printed circuit) cable	FPC cable	FPC cable

¹MIPI CSI-2 Mobile Industry Processor Interface Camera Serial Interface 2

Table 3: MIPI CSI-2 adapter board naming

Compliance, safety, and intended use



This chapter includes:

Compliance notifications	11
Intended use	11
Copyright and trademarks	11
Your safety	12
Product safety	12

Compliance notifications

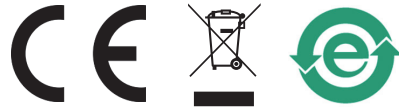

Intended use

Allied Vision's objective is the development, design, production, maintenance, servicing and distribution of digital cameras and components for image processing. We are offering standard products as well as customized solutions.

Intended use of Allied Vision product is the integration into Vision systems by professionals. All Allied Vision product is sold in a B2B setting.

Allied Vision isn't a legal manufacturer of medical product. Instead, Allied Vision cameras and accessories may be used as components for medical product after design-in by the medical device manufacturer and based on a quality assurance agreement (QAA) between Allied Vision (supplier) and medical device manufacturer (customer). Allied Vision's duties in that respect are defined by ISO 13485, clause 7.2 (customer-related processes, equivalent to ISO 9001, clause 8.2).

Copyright and trademarks

All text, pictures, and graphics are protected by copyright and other laws protecting intellectual property. All content is subject to change without notice.

All trademarks, logos, and brands cited in this document are property and/or copyright material of their respective owners. Use of these trademarks, logos, and brands does not imply endorsement.

Copyright © 2021 Allied Vision Technologies GmbH. All rights reserved.

Your safety

This section informs about issues related to your personal safety. Descriptions explain how to avoid hazards and use adapter boards safely.

Handling hot adapter boards

Electrical components of adapter boards get hot during operation.

Before operation, include adapter boards in housings that disable any contact to hot components.

Product safety

To prevent material damage, read the following to understand risks in using adapter boards.

Embedded systems

Setup and operation of Alvium CSI-2 cameras in embedded systems is different than for cameras in PC-based systems. Components can easily be damaged. If you are unfamiliar with embedded systems, be extremely careful. Follow the instructions in the Alvium CSI-2 Cameras User Guide.

Electrical connections

The MIPI CSI-2 standard does not specify electrical connections as extensively as the USB or GigE standard. Read specifications carefully.

Alvium CSI-2 cameras are not protected against damage caused by reverse polarity.

Electrostatic discharge (ESD)

Electrostatic discharge (ESD) is dangerous for electronic devices, especially when tools or hands get in contact with connectors. We recommend measures to avoid damage by ESD:

- **Unpacking:** Remove the adapter board from its anti-static packaging only when your body is grounded.
- **Workplace:** Use a static-safe workplace with static-dissipative mat and air ionization.
- **Wrist strap:** Wear a static-dissipative wrist strap to ground your body.
- **Clothing:** Wear ESD-protective clothing. Keep components away from your body and clothing. Even if you are wearing a wrist strap, your body is grounded but your clothes are not.

- Housing: use an ESD protective housing, including the camera, embedded board, adapter board, and FPC cable.

Camera power

Operating cameras beyond the specified range damages cameras. Cameras are powered using the FPC connector at a maximum input of 5.5 VDC, using a limited power source (LPS), according to IEC62368-1: 2014 (Second Edition) with maximum 1.5 A per camera. Cameras are not intended to be connected to DC distribution networks.

We recommend you to power cameras with USB 2.0 Micro B power supplies providing 4.5 to 5.5 VDC at 1.5 A.

FPC connectors

Hirose FH55-22S-0.5SH FPC connectors enable compact camera design. The small-sized connectors are sensitive to mechanical stress and are specified for maximum 20 mating and unmating cycles. Especially if you are inexperienced with this connector, be very cautious. If the FPC connector is broken, the complete device must be replaced. Follow the instructions in [Using the adapter board](#) on page 22 carefully.

- Avoid stress to FPC connectors.
- Allow only the FPC cable to touch conductors.

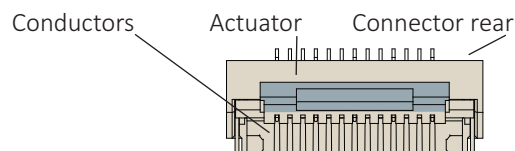

Figure 1: Hirose FH55-22S-0.5SH FPC connector



Additional information

For technical data and more instructions on the Hirose FH55-22S-0.5SH connector, see the manufacturer data sheet at www.hirose.com.

Handling the actuator

- Move the actuator only between 0° (locked position) to 105° (open position).
- Carefully flip the actuator at the middle with your finger nail, see [Connecting FPC cables to Hirose FPC connectors](#) on page 23.

MIPI CSI-2 FPC cables



Manufacturing FPC cables or embedded boards

If you want to design your own components to connect Alvium CSI-2 cameras to embedded boards, contact your Allied Vision Sales representative or visit www.alliedvision.com/en/about-us/contact-us/technical-support-repair-/-rma.

FPC cable position

Short circuits of the FPC cable can damage the camera or connected hardware.

- Insert the FPC cable into the connector with cable guiding tabs matching the connector's side guides. See [Connecting FPC cables to Hirose FPC connectors](#) on page 23.
- Connect the camera and the embedded board (adapter) only as shown by the arrow printed on the FPC cable, see [Connecting FPC cables to Hirose FPC connectors](#) on page 23.

FPC cables and stress

Over-stressed FPC cables can damage the camera and connected hardware. When camera and embedded board are twisted against each other or pulled apart from each other with too much force, the FPC cable is over-stressed. Spring contacts of FPC connectors are worn out, causing short circuits and unreliable electrical connections.

- Insert the FPC cable into the FPC connector at 12° to the PCB board surface. See [Connecting FPC cables to Hirose FPC connectors](#) on page 23.
- Allow only slight bending of the FPC cable (minimum bending radius: 10 mm).
- For strain relief, we recommend you to mount the embedded board, adapter board, and camera to a common base.

No hot-plugging for MIPI CSI-2

Alvium CSI-2 cameras do not support hot-plugging. Hot-plugging can destroy the camera and connected hardware by high inrush current.

- Disconnect power supplies before connecting FPC cables.

FPC cable signal quality

Noise and electromagnetic interference can disable camera functions.

- Avoid contact to metal surfaces, causing electromagnetic interference.
- Please use cables recommended by Allied Vision.

FFCs and FFC connectors

Treat FFCs and FFC connectors as carefully as FPC connectors to avoid damage to adapter boards and embedded boards.

For details on FFC connectors, see the embedded board's technical manual.

I/O connections

Through the adapter board, the camera connects to the embedded board. To reduce signal latencies, I/O cables can be connected directly to the adapter board. This includes soldering.

- Do soldering only if you have sufficient working knowledge.
- Follow the instructions in [Connecting the I/Os](#) on page 29.

Specifications



This chapter includes:

Specifications	17
Dimensions and PCB layout	18
Electronic schematics	19
Camera power	21
I/O connections.....	21

Specifications

Feature	Specification
Product code	14908
PCB number	14276 (see PCB and PCBA number below)
PCBA number	14275 (see PCB and PCBA number below)
Dimensions (Length × width × height [mm])	36.6 × 24 × 4.2
Mass (adapter board only)	4 g
Storage temperature	-10 °C to +70 °C ambient temperature
Operating temperature	+5 °C to +65 °C
Relative humidity	0% to 80% (non-condensing)
Supported embedded boards	Toradex Ixora Carrier Board
FFC (included in delivery)	Würth 687624050002 WR-FFC 24-pin, 0.5 mm pitch flat flexible cable type 1 (contacts on the same side), length 50 mm
Supported cameras	Alvium CSI-2 cameras
Supported FPC cables for camera connections	Allied Vision 12316, 12317, 12318

Table 4: Adapter for Toradex Ixora specifications

PCB and PCBA number

The PCB number is printed on the backside, the PCBA number is placed anywhere on the circuit board, for example, like this:

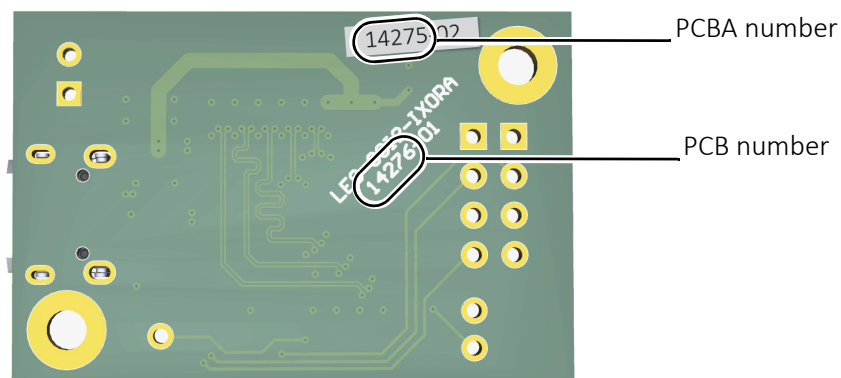

Figure 2: PCB and PCBA number on the adapter board

Dimensions and PCB layout

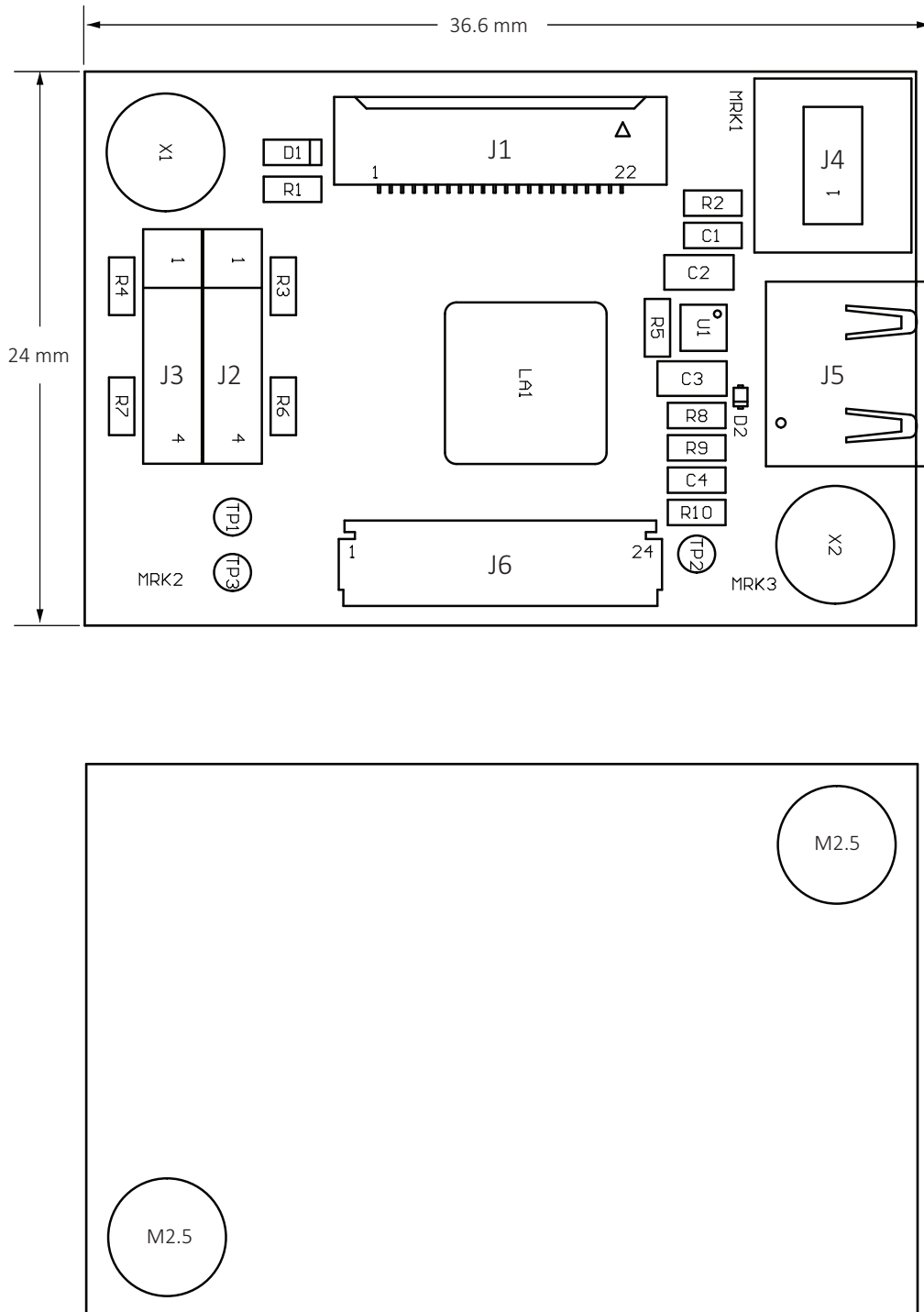
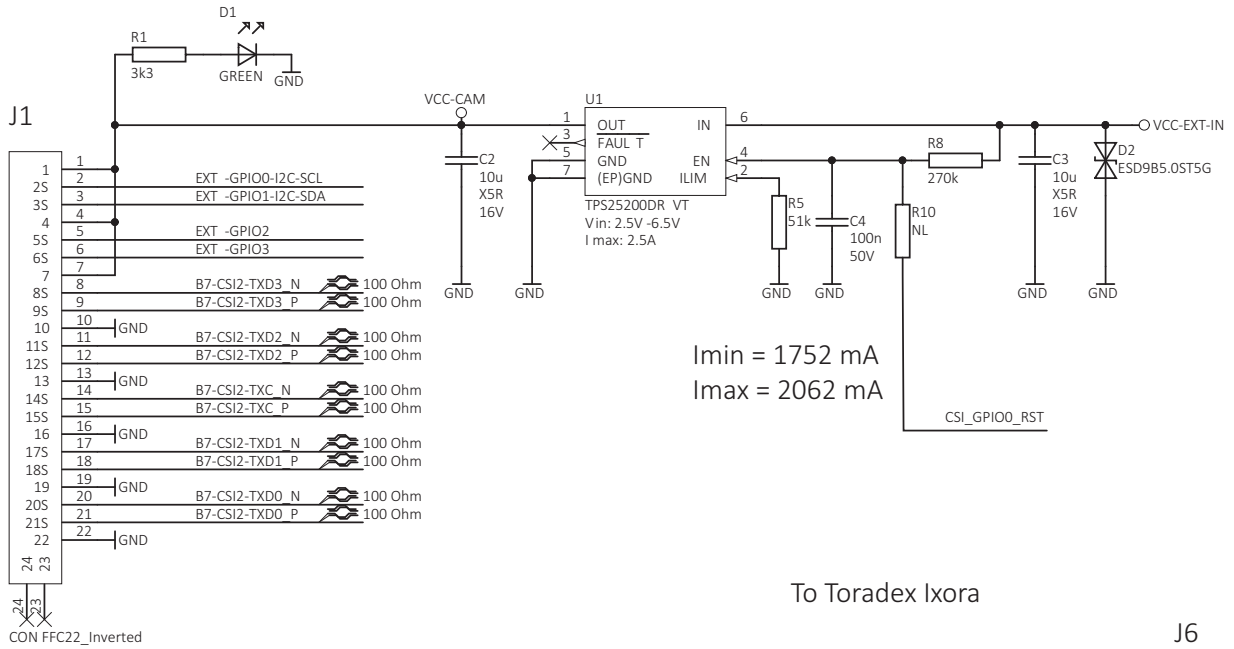

Figure 3: Adapter for Toradex Ixora dimensions and PCB layout

Electronic schematics

To Alvium cameras



To Toradex Ixora

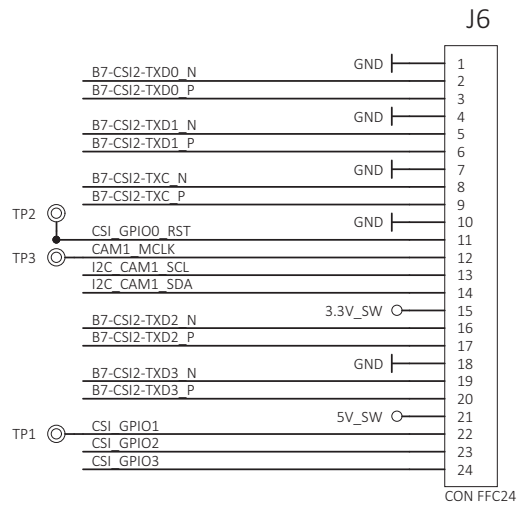

I2C

Note: J3 is not equipped.

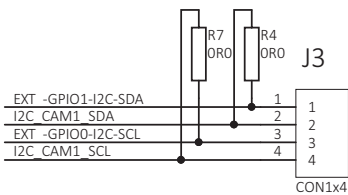

GPIOs

Note: J2 is not equipped.

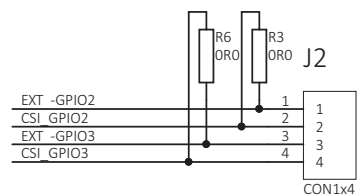

Figure 4: Adapter for Toradex Ixora electronic schematics, part 1



NOTICE

Damage to the camera power supply

- We recommend you to power Alvium cameras using the USB connector J5.
- Ensure the power supply provides sufficient current for the connected camera.

VCC-EXT-IN: DCIN 4V5 .. 5V5, max. 1.5 A

External USB power

External power

Note: J4 is not equipped.

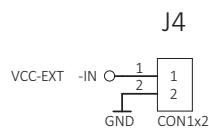
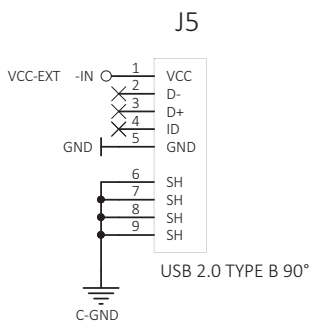

Ixora power (max. 500 mA)

Note: R9 is not equipped.



GND <-> Chassis-GND

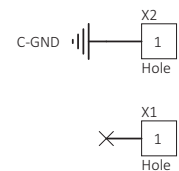
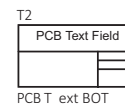
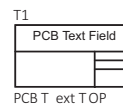
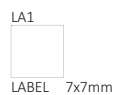
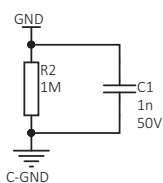

Figure 5: Adapter for Toradex Ixora electronic schematics, part 2

Camera power



NOTICE

Damage to power supplies

If power supplies do not provide sufficient current, they may be damaged.

Ensure USB power supplies provide 1.5 A.

Power Alvium cameras using the USB 2.0 Micro B receptacle (J5). See the description in [Figure 5, Adapter for Toradex Ixora electronic schematics, part 2](#) on page 20.

I/O connections

You can use the I/O lines to trigger the camera or to output a signal from the camera to trigger a device, such as a strobe light to control illumination. Through the adapter board, the camera connects to the embedded board:

Camera Line	Embedded board line
EXT-GPIO2	CSI_GPIO2
EXT-GPIO3	CSI_GPIO3

Table 5: I/O connections from the camera to the embedded board

If you want to reduce signal latencies, such as for triggering the camera by a light barrier, you can connect I/O cables directly to the adapter board. Please see the instructions in [Connecting the I/Os](#) on page 29.

Using the adapter board



This chapter includes:

Embedded system accessories	23
Connecting FPC cables to Hirose FPC connectors	23
Installing adapter boards	25

Embedded system accessories



FPC cables

For more information, see the Alvium Cameras Accessory Guide at www.alliedvision.com/en/support/technical-documentation/alvium-csi-2-documentation



Designing your own embedded components

If you want to design your own components to connect Alvium CSI-2 cameras to embedded boards, contact your Allied Vision Sales representative or visit www.alliedvision.com/en/about-us/contact-us/technical-support-repair-/rma.

Proper usage of the Hirose FH55-22S-0.5SH FPC connector is vital for connecting Alvium CSI-2 cameras to embedded boards. Therefore, instructions start with usage of the FPC connector. Afterwards, setting up the adapter boards is described.

Connecting FPC cables to Hirose FPC connectors

Figure 6 shows how the FPC cable connects to the FPC connector.

Follow the instructions to connect the FPC cable to the camera and to the embedded board.

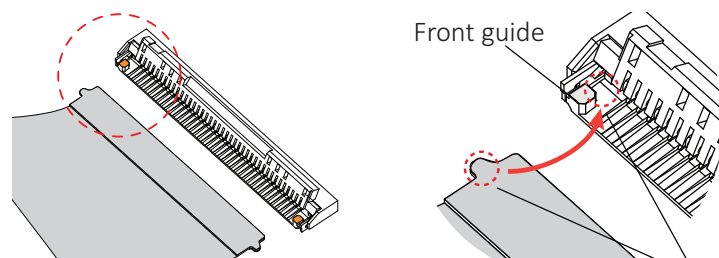

Figure 6: FPC cable and FPC connector (open position)

1. Opening the FPC connector:
With your fingernail*, flip the actuator to open position at 105° to the PCB surface, see Figure 7.

*Or use a plastic tool, as metal tools can damage the actuator.

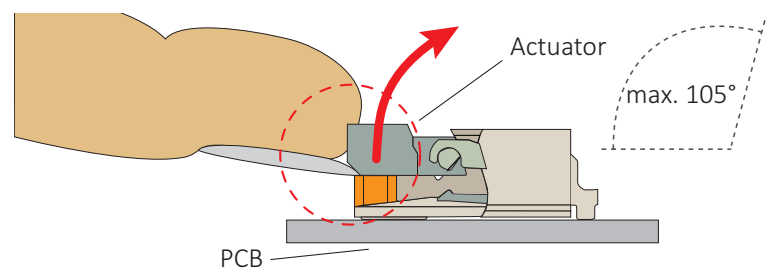

Figure 7: Opening the FPC connector

NOTICE
Damage to the camera by reverse polarity

If Alvium CSI-2 cameras are powered with reverse polarity, camera electronics is damaged.

- Before connecting camera power and I/O power, carefully read the Alvium Cameras User Guide for the FPC connector pin assignment.
- Connect the cable as shown in this section.

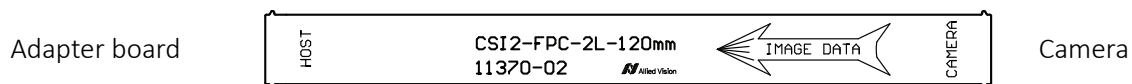

Figure 8: FPC cable image data direction

2. **Ensuring proper cable direction between host and camera**, take the FPC cable with conductors facing the FPC connector conductors (see Figure 9).

3. Inserting the FPC cable:
At a horizontal angle of 90° to the connector's rear (see Figure 9) and at a vertical angle of 12° to the PCB (see Figure 10), slowly insert the FPC cable into the actuator...

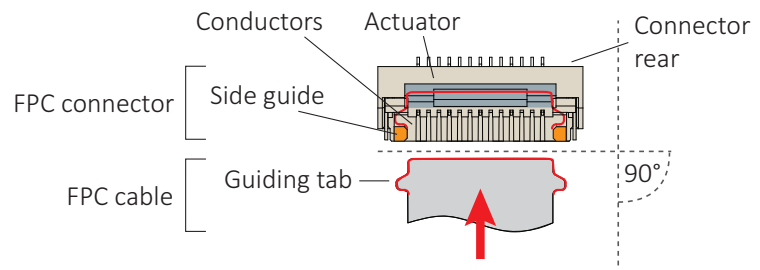

Figure 9: FPC cable and FPC connector

4. ...until cable guiding tabs are caught between connector rear and side guides (see Figure 9). Pull the cable slightly to ensure guiding tabs are properly engaged.
5. Holding the FPC cable in position, flap down the actuator to closed position (see Figure 10).

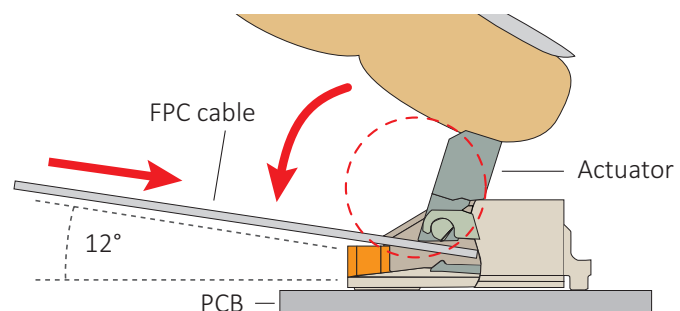

Figure 10: Engaging the FPC cable in the FPC connector

Installing adapter boards



CAUTION

Burns to the skin

Electrical components get hot during operation.

Before operation, include adapter boards in housings that disable any contact to hot components.



NOTICE

Damage to electronics

- Disconnect all power supplies before installing the adapter board to your embedded board.
- Reconnect power only after installation is complete.
- Mount the embedded board, adapter board, and camera on a common base for strain relief.



Toradex Ixora Carrier Board Manual

For details on the Toradex Ixora Carrier Board, including FFC connectors, see the manufacturer's manual at www.toradex.com.

Connecting the FFC

1. With the conductors (a) facing the PCB of the adapter board,...

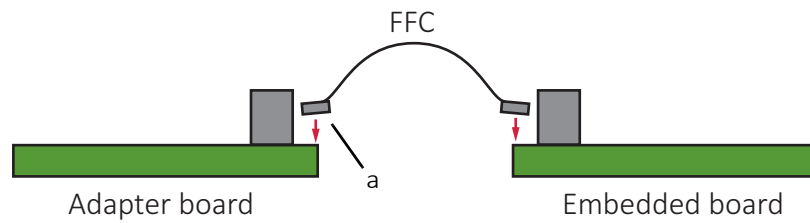

Figure 11: Inserting the FFC

...connect the FFC to the embedded board connector (b) of the adapter board.

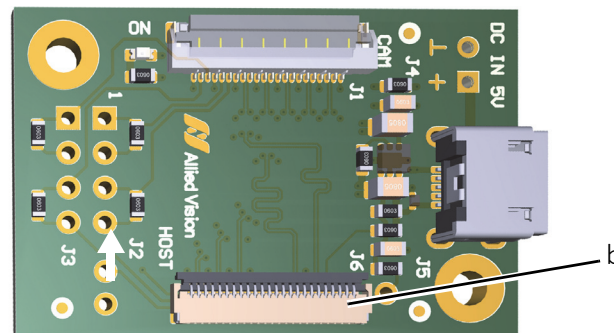

Figure 12: Embedded board connector of the adapter board

Connecting the embedded board

1. With the conductors (c) facing the PCB of the embedded board...

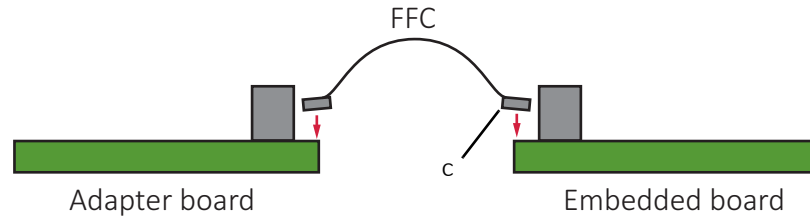

Figure 13: Inserting the FFC

...connect the FFC to the camera connector of the embedded board.

Connecting the camera

1. Following the instructions in [Connecting FPC cables to Hirose FPC connectors](#) on page 23, connect the FPC cable to the FPC camera connector (d).
2. Connect the other end of the FPC cable to the camera.

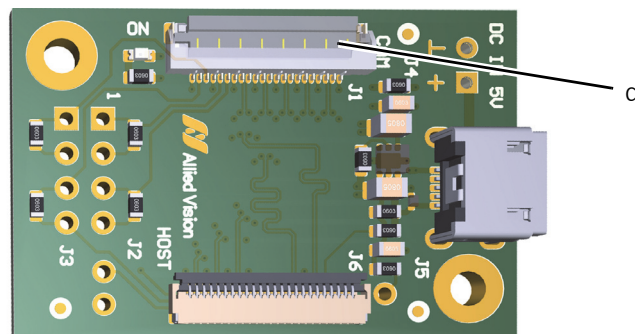

Figure 14: FPC camera connectors of the adapter board

Your Alvim CSI-2 camera is connected to the embedded board.

Connecting USB power

We recommend you to power the camera using USB power.



NOTICE

Damage to power supplies

If power supplies do not provide sufficient current, they may be damaged. Ensure USB power supplies provide 1.5 A.

1. Ensure the USB power supply is disconnected from the mains power.
2. Connect the power supply's output connector to the USB 2.0 Micro B receptacle (e).

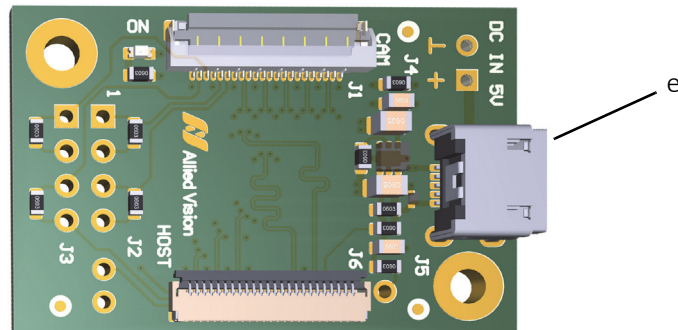

Figure 15: USB connector of the adapter board

3. Connect the power supply to the mains power.
4. Power and boot the embedded board.

Your Alvim CSI-2 camera can be operated via the embedded board.

Connecting the I/Os

If you want to use the I/O lines of the **embedded board**, see [I/O connections](#) on page 21. This way, you can use the I/Os immediately.

If you want to use the I/O lines of the **adapter board**, see the following instruction. This way, you reduce signal latencies, such as for triggering the camera by a light barrier



About this instruction

This is a best-practice solution. Please visit www.alliedvision.com/en/about-us/contact-us/technical-support-repair/-rma if you have any questions.



NOTICE

Damage to the adapter board

Improper soldering can cause copper pads to come loose from the PCB. To ensure soldering does not damage the adapter board:

- Keep soldering temperature low.
- Allow only short contact time between the soldering tip and the PCB.
- Use only minimal force to desolder the resistors.

1. Desolder the resistors R3 (f) and R6 (g).
2. Solder a pin header (h) to J2.

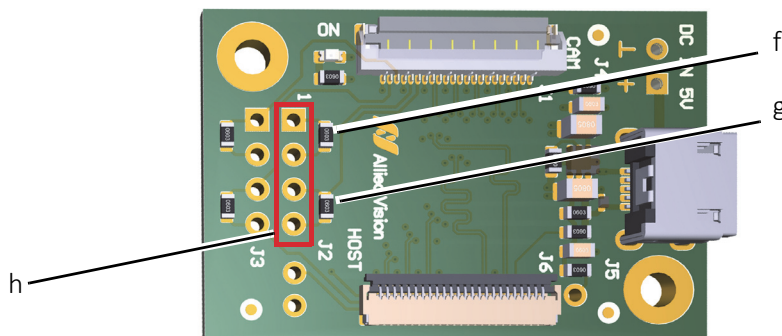

Figure 16: Desoldering resistors and soldering a pin header

3. Connect GND to pin 2 (i) on connector J4.

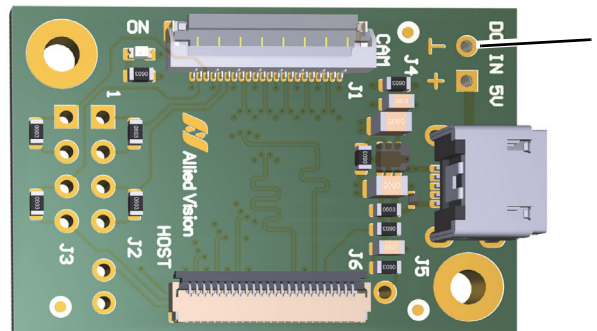

Figure 17: Connecting GND

4. On the pin header (h), use the I/O pins defined in [I/O signal levels and description](#) on page 31.



Figure 18: Connecting the I/Os

I/O signal levels and description

Table 6 displays the signals for the GPIOs on connector J2, for GND on connector J4, and for VCC-EXT-IN on the USB connector J5.

Connector	Pin	Signal	< - >	Level	Description
J2	1	EXT-GPIO2	IN/OUT	$U_{in} \text{ (low)} = -0.3 \text{ to } 0.8 \text{ VDC}$ $U_{in} \text{ (high)} = 2.0 \text{ to } 5.5 \text{ VDC}$ $U_{out} \text{ (low)} = 0 \text{ to } 0.4 \text{ VDC}$ $U_{out} \text{ (high)} = 2.4 \text{ to } 3.3 \text{ VDC}$ at max. 12 mA	GPIO Internal pull-up resistor: 33 k Ω to 63 k Ω
J2	2	CSI_GPIO2	IN/OUT	See the manufacturer documentation	GPIO
J2	3	EXT-GPIO3		See EXT-GPIO2	
J2	4	CSI_GPIO3		See CSI_GPIO2	
J4	1	VCC-EXT-IN	PWR IN	4.5 to 5.5 VDC	Connects to J5, pin 1
J4	2	GND	PWR	0 VDC	Power supply ground
J5	1	VCC-EXT-IN	PWR IN	4.5 to 5.5 VDC	USB power supply Maximum input current: 1.5 A

Table 6: I/O connections from the adapter board to the camera



Connections with Toradex Ixora Carrier Board

For information on CSI_GPIO3 and CSI_GPIO3, please see the manufacturer website: www.toradex.com.