

# inspired LED 8mm Micro-Lock Tiger Paw<sup>®</sup> Connector

Inspired LED's patented solderless **Tiger Paw<sup>®</sup> Connectors** are the perfect solution for in-field LED system design and customization. These innovative accessories pair with LED flex strips for quick, convenient installation. Now, creating the perfect low-voltage lighting system is easier than ever, thanks to Inspired LED!

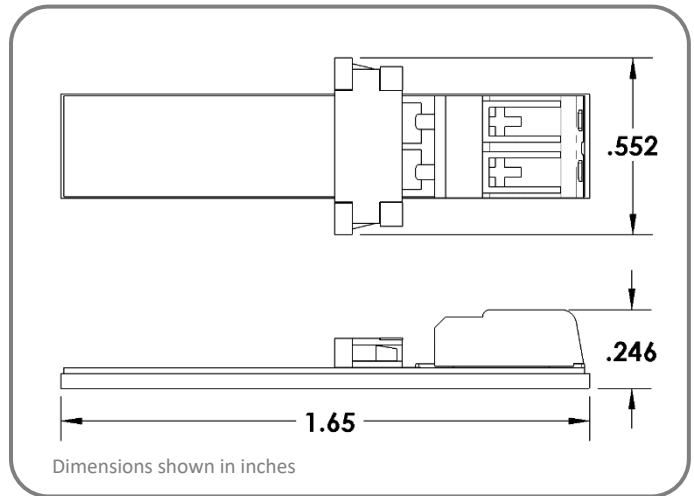
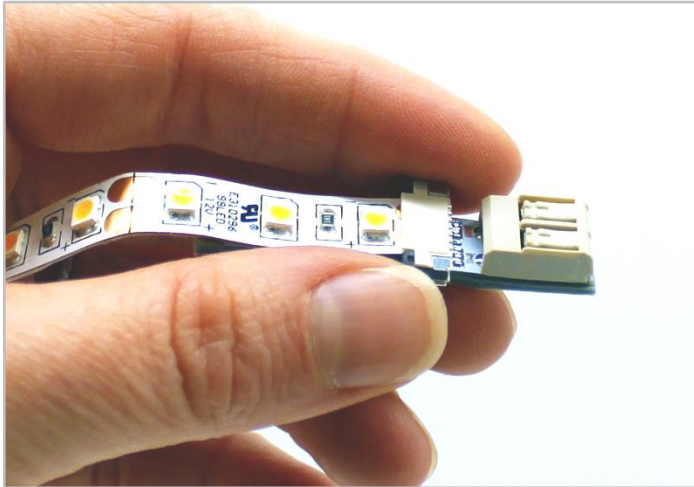

## Product Specifications: SKU# 3613

- Solderless termination of 8mm LED flex strips to 16-22 AWG solid cable
- Max Load- 5 AMPs • Net Wt. 2g • VHB adhesive backing included
- Industry proven locking system meets shock and vibration requirements for IEC 60068-2-27
- U.S. Patent No. 8,714,772

## Instructions:

**1** Use scissors to cut LED strip to length along copper solder pads ONLY (located every 3 LEDs).

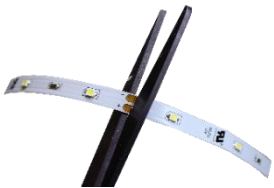

**2** Take hold of black sliding latch and pull outward to open.

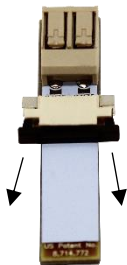

**3** Peel back adhesive lining on LED strip about 1/2 inch.

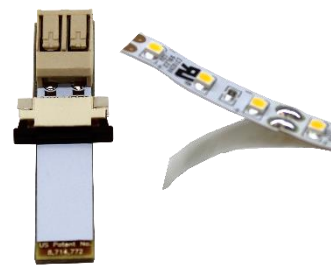

**4** Insert flex strip into gap between black sliding latch and beige bridge piece.



**5** Make sure LED strip is centered and fully inserted before sliding black latch firmly closed and pressing on adhesive.

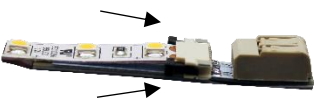

**6** Strip 16-22 AWG solid cable back about 1/4 inch, taking note of positive and negative polarity.

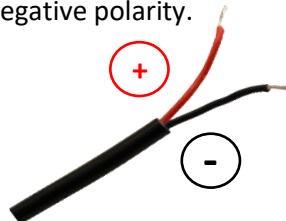

**7** Match polarity of wires to polarity of LEDs as marked with +/- signs along the flex strip, then firmly insert wires into micro lock.



**8** Ensure wires are secure and connect to Class 2 DC power, then remove remaining adhesive lining to install.

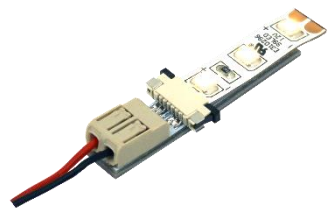

**Troubleshooting:** If LEDs are flickering, double check connection to be sure flex is fully inserted and secured, if no lights turn on check to be sure polarities are properly matched.



inspiredled.com



orders@inspiredled.com



(480) 941-4286