

SPECIFICATION
Of
TEMPERATURE SENSOR

PART NUMBER: **TT-PT100B-2050-11-AuNi**

No. of pages: 1

Date: **22.10.2018**

Revision: **00**

FEATURES:

No-load resistance at 0°C	100 Ω
Tolerance Class	B
Tolerance range	-70°C ÷ 400°C
Max temperature	500°C
Response time (Time constant:63.2%)/sec	0.4 sec (stirred water)
Response time (Time constant:63.2%)/sec	4.8 sec (still air)
TCR	3851ppm/°C

DRAWING:

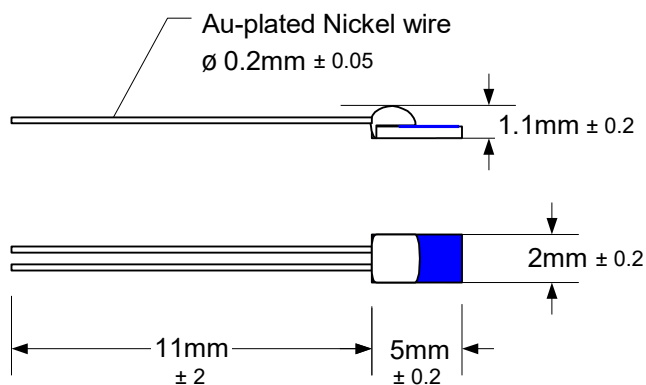

UNITS: [mm]