

# ***TLV320DAC26EVM*** ***DAC Evaluation Module***

## *User's Guide*

## IMPORTANT NOTICE

Texas Instruments Incorporated and its subsidiaries (TI) reserve the right to make corrections, modifications, enhancements, improvements, and other changes to its products and services at any time and to discontinue any product or service without notice. Customers should obtain the latest relevant information before placing orders and should verify that such information is current and complete. All products are sold subject to TI's terms and conditions of sale supplied at the time of order acknowledgment.

TI warrants performance of its hardware products to the specifications applicable at the time of sale in accordance with TI's standard warranty. Testing and other quality control techniques are used to the extent TI deems necessary to support this warranty. Except where mandated by government requirements, testing of all parameters of each product is not necessarily performed.

TI assumes no liability for applications assistance or customer product design. Customers are responsible for their products and applications using TI components. To minimize the risks associated with customer products and applications, customers should provide adequate design and operating safeguards.

TI does not warrant or represent that any license, either express or implied, is granted under any TI patent right, copyright, mask work right, or other TI intellectual property right relating to any combination, machine, or process in which TI products or services are used. Information published by TI regarding third-party products or services does not constitute a license from TI to use such products or services or a warranty or endorsement thereof. Use of such information may require a license from a third party under the patents or other intellectual property of the third party, or a license from TI under the patents or other intellectual property of TI.

Reproduction of information in TI data books or data sheets is permissible only if reproduction is without alteration and is accompanied by all associated warranties, conditions, limitations, and notices. Reproduction of this information with alteration is an unfair and deceptive business practice. TI is not responsible or liable for such altered documentation.

Resale of TI products or services with statements different from or beyond the parameters stated by TI for that product or service voids all express and any implied warranties for the associated TI product or service and is an unfair and deceptive business practice. TI is not responsible or liable for any such statements.

Following are URLs where you can obtain information on other Texas Instruments products and application solutions:

<b>Products</b>		<b>Applications</b>	
Amplifiers	<a href="http://amplifier.ti.com">amplifier.ti.com</a>	Audio	<a href="http://www.ti.com/audio">www.ti.com/audio</a>
Data Converters	<a href="http://dataconverter.ti.com">dataconverter.ti.com</a>	Automotive	<a href="http://www.ti.com/automotive">www.ti.com/automotive</a>
DSP	<a href="http://dsp.ti.com">dsp.ti.com</a>	Broadband	<a href="http://www.ti.com/broadband">www.ti.com/broadband</a>
Interface	<a href="http://interface.ti.com">interface.ti.com</a>	Digital Control	<a href="http://www.ti.com/digitalcontrol">www.ti.com/digitalcontrol</a>
Logic	<a href="http://logic.ti.com">logic.ti.com</a>	Military	<a href="http://www.ti.com/military">www.ti.com/military</a>
Power Mgmt	<a href="http://power.ti.com">power.ti.com</a>	Optical Networking	<a href="http://www.ti.com/opticalnetwork">www.ti.com/opticalnetwork</a>
Microcontrollers	<a href="http://microcontroller.ti.com">microcontroller.ti.com</a>	Security	<a href="http://www.ti.com/security">www.ti.com/security</a>
		Telephony	<a href="http://www.ti.com/telephony">www.ti.com/telephony</a>
		Video & Imaging	<a href="http://www.ti.com/video">www.ti.com/video</a>
		Wireless	<a href="http://www.ti.com/wireless">www.ti.com/wireless</a>

Mailing Address: Texas Instruments  
Post Office Box 655303 Dallas, Texas 75265

## EVM IMPORTANT NOTICE

Texas Instruments (TI) provides the enclosed product(s) under the following conditions:

This evaluation kit being sold by TI is intended for use for **ENGINEERING DEVELOPMENT OR EVALUATION PURPOSES ONLY** and is not considered by TI to be fit for commercial use. As such, the goods being provided may not be complete in terms of required design-, marketing-, and/or manufacturing-related protective considerations, including product safety measures typically found in the end product incorporating the goods. As a prototype, this product does not fall within the scope of the European Union directive on electromagnetic compatibility and therefore may not meet the technical requirements of the directive.

Should this evaluation kit not meet the specifications indicated in the EVM User's Guide, the kit may be returned within 30 days from the date of delivery for a full refund. **THE FOREGOING WARRANTY IS THE EXCLUSIVE WARRANTY MADE BY SELLER TO BUYER AND IS IN LIEU OF ALL OTHER WARRANTIES, EXPRESSED, IMPLIED, OR STATUTORY, INCLUDING ANY WARRANTY OF MERCHANTABILITY OR FITNESS FOR ANY PARTICULAR PURPOSE.**

The user assumes all responsibility and liability for proper and safe handling of the goods. Further, the user indemnifies TI from all claims arising from the handling or use of the goods. Please be aware that the products received may not be regulatory compliant or agency certified (FCC, UL, CE, etc.). Due to the open construction of the product, it is the user's responsibility to take any and all appropriate precautions with regard to electrostatic discharge.

**EXCEPT TO THE EXTENT OF THE INDEMNITY SET FORTH ABOVE, NEITHER PARTY SHALL BE LIABLE TO THE OTHER FOR ANY INDIRECT, SPECIAL, INCIDENTAL, OR CONSEQUENTIAL DAMAGES.**

TI currently deals with a variety of customers for products, and therefore our arrangement with the user **is not exclusive**.

TI assumes **no liability for applications assistance, customer product design, software performance, or infringement of patents or services described herein**.

Please read the EVM User's Guide and, specifically, the EVM Warnings and Restrictions notice in the EVM User's Guide prior to handling the product. This notice contains important safety information about temperatures and voltages. For further safety concerns, please contact the TI application engineer.

Persons handling the product must have electronics training and observe good laboratory practice standards.

No license is granted under any patent right or other intellectual property right of TI covering or relating to any machine, process, or combination in which such TI products or services might be or are used.

Mailing Address:

Texas Instruments  
Post Office Box 655303  
Dallas, Texas 75265

## **EVM WARNINGS AND RESTRICTIONS**

It is important to operate this EVM within the input voltage range of 6 VDC to 10 VDC and the output voltage range of 3 VDC described in the EVM User's Guide.

Exceeding the specified input range may cause unexpected operation and/or irreversible damage to the EVM. If there are questions concerning the input range, please contact a TI field representative prior to connecting the input power.

Applying loads outside of the specified output range may result in unintended operation and/or possible permanent damage to the EVM. Please consult the EVM User's Guide prior to connecting any load to the EVM output. If there is uncertainty as to the load specification, please contact a TI field representative.

During normal operation, some circuit components may have case temperatures greater than 40°C. The EVM is designed to operate properly with certain components above 40°C as long as the input and output ranges are maintained. These components include but are not limited to linear regulators, switching transistors, pass transistors, and current sense resistors. These types of devices can be identified using the EVM schematic located in the EVM User's Guide. When placing measurement probes near these devices during operation, please be aware that these devices may be very warm to the touch.

### **Mailing Address:**

Texas Instruments  
Post Office Box 655303  
Dallas, Texas 75265

# Read This First

---

---

---

---

### ***About This Manual***

This user's guide describes the function and operation of the TLV320DAC26, or simply DAC26, audio codec evaluation module. The manual helps users to quickly set up the evaluation board and its accompanying software, so that they can rapidly test and evaluate the DAC26. A complete circuit description, schematic diagram, and bill of materials are included.

### ***How to Use This Manual***

This manual begins with an introductory chapter that describes the EVM and what it can do. To set up the EVM and start testing quickly, read at least the first two chapters. These two chapters introduce the board and how to set it up. Later chapters go into more detail about the board design and how to access its many features.

### ***Information About Cautions and Warnings***

This document may contain cautions and warnings.

**This is an example of a caution statement.**

**A caution statement describes a situation that could potentially damage your software or equipment.**

**This is an example of a warning statement.**

**A warning statement describes a situation that could potentially cause harm to you.**

The information in a caution or a warning is provided for your protection. Please read each caution and warning carefully.

### **Related Documentation From Texas Instruments**

To obtain a copy of any of the following TI documents, call the Texas Instruments literature response center at (800) 477–8924 or the product information center (PIC) at (972) 644–5580. When ordering, identify this user’s guide by its title and literature number. Updated documents can also be obtained through the TI Web site at [www.ti.com](http://www.ti.com).

<b>Data Sheets:</b>	<b>Literature Number:</b>
TLV320DAC26	SLAS428
TAS1020B	SLES025A
TPS767D318	SLVS209D
SN74LVC125A	SCAS290M

### **If You Need Assistance**

If you have questions about this or other Texas Instruments data converter evaluation modules, send an e–mail to the data converter application team at [dataconvapps@list.ti.com](mailto:dataconvapps@list.ti.com). Include the product name in the subject heading.

### **FCC Warning**

This equipment is intended for use in a laboratory test environment only. It generates, uses, and can radiate radio frequency energy and has not been tested for compliance with the limits of computing devices pursuant to subpart J of part 15 of FCC rules, which are designed to provide reasonable protection against radio frequency interference. Operation of this equipment in other environments may cause interference with radio communications, in which case the user at his own expense will be required to take whatever measures may be required to correct this interference.

### **Trademarks**

Windows is a registered trademark of Microsoft Corporation.  
TouchTek 4 and MicroTouch are trademarks of 3M.

# Contents

---

---

---

<b>1</b>	<b>Introduction</b>	<b>1-1</b>
1.1	Device Characteristics	1-2
1.2	EVM Block Diagram	1-2
1.3	Analog Outputs/Inputs	1-3
1.4	Power Requirements	1-3
1.5	Computer Requirements	1-3
<b>2</b>	<b>Getting Started</b>	<b>2-1</b>
2.1	Unpacking the EVM	2-2
2.2	Default Configuration	2-2
2.3	Quick Start	2-2
<b>3</b>	<b>Operation</b>	<b>3-1</b>
3.1	Jumpers	3-2
3.1.1	Differential Microphone Input	3-2
3.1.2	MIC BIAS Selection	3-2
3.1.3	EEPROM A1 Select	3-2
3.1.4	Power Supply Selection	3-2
3.1.5	Power Supply Current Measurement	3-3
3.1.6	IOVDD Voltage Selection	3-3
3.2	Switches	3-3
3.2.1	SPI Selection	3-3
3.2.2	I <sup>2</sup> S Selection	3-3
3.2.3	MCLK Selection	3-4
3.2.4	USB Reset	3-4
3.3	I/O Connector and Signals	3-4
3.3.1	Analog Connectors	3-4
3.3.2	USB Interface Connector	3-5
3.3.3	External Power Connectors	3-5
3.3.4	External Audio Data (I <sup>2</sup> S) Connector	3-5
3.3.5	External SPI Connector	3-6
3.3.6	Analog Input Connector	3-6
3.4	Circuit Description	3-6
3.4.1	USB Microprocessor	3-6
3.4.2	Power Supply	3-7
3.4.3	Analog Outputs	3-8
3.5	Program Description	3-8
3.5.1	Register Reading Screen	3-8
3.5.2	DAC Configuration Screen	3-11
3.5.3	DAC Output Filters Screen	3-13

<b>4</b>	<b>Physical Description</b>	<b>4-1</b>
4.1	Component Locations	4-2
4.2	Bill of Materials	4-3
4.3	Schematics	4-6

## Figures

---



---



---

1-1	DAC26 Evaluation Kit Block Diagram	1-2
2-1	Default Software Screen	2-3
3-1	Register Reading Screen With Control Registers Reading	3-9
3-2	Register Reading Screen With Boost Filter Parameters	3-10
3-3	DAC Configuration Screen	3-11
3-4	DAC Output Filter Screen	3-14

## Tables

---



---



---

2-1	Default Configuration Settings	2-2
3-1	Jumper/Function Reference	3-2
3-2	Switch Function Reference	3-3
3-3	Audio Connectors	3-4
3-4	USB Interface Connector	3-5
3-5	External Power Connectors	3-5
3-6	Audio Data Connector	3-5
3-7	External SPI Connector	3-6
3-8	Analog Input Connector	3-6



# Introduction

---

---

---

---

The DAC26 is a low-power, high-performance audio band DAC with dual or stereo output. The DAC26 has two digital interface buses that communicate with a host processor: the SPI interface and the I<sup>2</sup>S interface. The SPI serial interface is for a host processor to control the DAC26, and the DAC data is communicated to the DAC26 over the I<sup>2</sup>S bus. The DAC26 accesses both of these buses through the use of a USB microcontroller, which provides a way to generate data for both buses from a PC running Windows® 98, Windows 2000, or Windows XP.

<b>Topic</b>	<b>Page</b>
<b>1.1 Device Characteristics</b> .....	<b>1-2</b>
<b>1.2 EVM Block Diagram</b> .....	<b>1-2</b>
<b>1.3 Analog Outputs</b> .....	<b>1-3</b>
<b>1.4 Power Requirements</b> .....	<b>1-3</b>
<b>1.5 Computer Requirements</b> .....	<b>1-3</b>

## 1.1 Device Characteristics

The DAC26 is an audio band DAC with headphone/speaker amplifier. The DAC26 has audio playback capability. Access to the audio DAC section of the DAC26 is through an I<sup>2</sup>S interface. The DAC26 interfaces to the host controller through a standard SPI serial interface.

## 1.2 EVM Block Diagram

A block diagram of the DAC26 evaluation kit is shown in Figure 1–1.

Figure 1–1. DAC26 Evaluation Kit Block Diagram

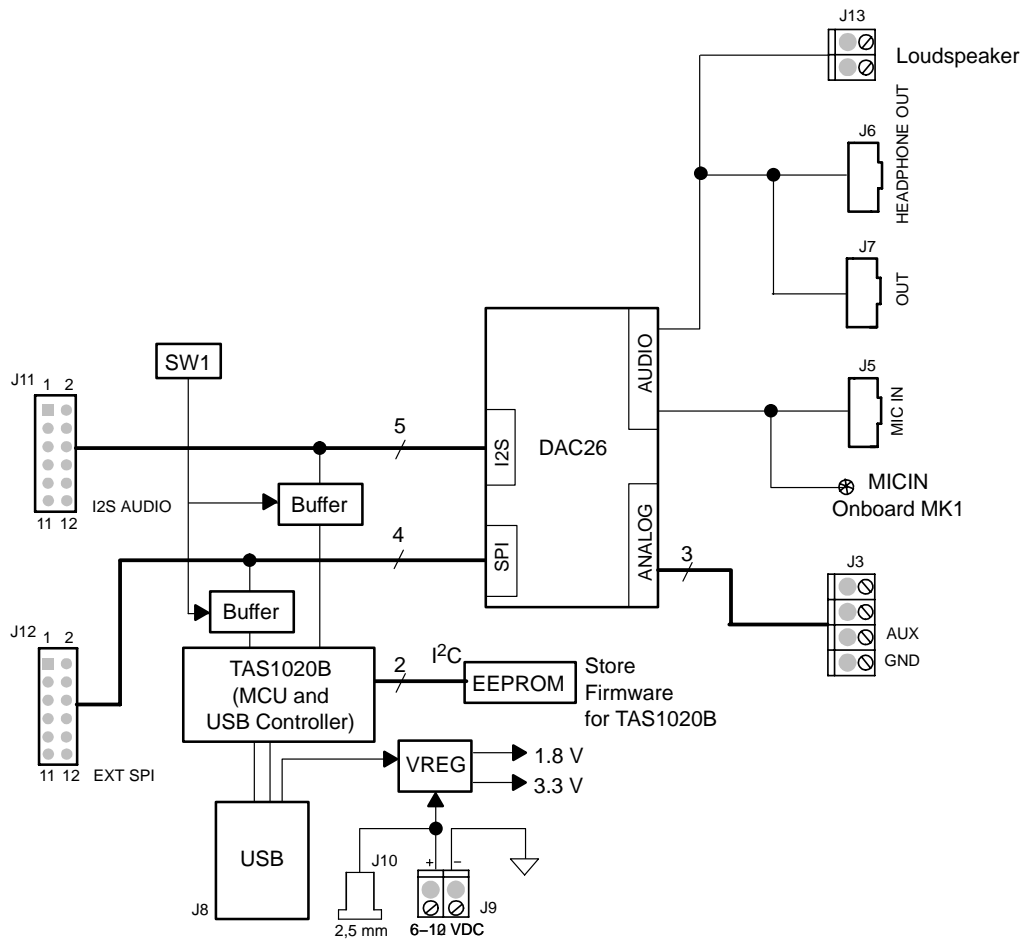

The digital control interface is through either the USB bus or an external SPI bus. The onboard microprocessor can be disabled, allowing the external SPI bus to control the DAC26.

Power supplies are derived from the USB bus or may be provided to the kit through external connectors from an external user-supplied laboratory power supply.

### 1.3 Analog Outputs/Inputs

The audio output is accessed through connectors J6, J7, and/or terminal block J13. To test the DAC26 sidetone function, the audio signal input can be from either the onboard microphone MKI or an external microphone connected to J5.

### 1.4 Power Requirements

The DAC26EVM can be powered from either the USB port or an external 6-VDC to 10-VDC power supply.

### 1.5 Computer Requirements

The DAC26EVM software is designed to run on a PC running Windows™ platforms that support USB (Windows™ 98SE, 2000, XP, etc).

Minimum requirements include:

- IBM-compatible Pentium PC or higher
- Windows™ 98SE/2000/XP
- 64-MByte RAM minimum
- 20-MByte available hard disk space
- CD-ROM drive
- USB Port



**THIS PAGE INTENTIONALLY LEFT BLANK**

# Getting Started

---

---

---

---

This chapter provides guidance for unpacking the EVM and setting it up for immediate operation.

<b>Topic</b>	<b>Page</b>
<b>2.1 Unpacking the EVM</b> .....	<b>2-2</b>
<b>2.2 Default Configuration</b> .....	<b>2-2</b>
<b>2.3 Quick Start</b> .....	<b>2-2</b>

## 2.1 Unpacking the EVM

When unpacking the DAC26EVM, make sure that the EVM kit includes the following:

- DAC26EVM board, PWB 6444324
- CD-ROM, 6463159

If any of these components is missing, contact Texas Instruments for a replacement.

## 2.2 Default Configuration

The DAC26EVM features a few, simple means of configuring its operation. Table 2–1 shows the default settings for these items. After unpacking the DAC26EVM, make sure that the board is initially configured as listed in the table.

Table 2–1. Default Configuration Settings

Board Identifier	Description	Default Setting	
JMP1	Differential MIC input	Not installed	
JMP2	MIC BIAS select	2 to 3	
JMP3	A1 select for EEPROM	Installed	
JMP4	PWR select	1 to 2	
JMP9	IOVDD selected as 3.3 V	1 to 2	
SW1	Onboard TAS1020B enable	Onboard I2S	SW1_1 ON
		Onboard MCLK	SW1_2 ON
		Onboard SPI	SW1_3 ON
		USB reset	SW1_4 ON

**NOTE:** JMP5 through JMP8 are installed by default. These jumpers can be removed and replaced by current meters for evaluating or testing the corresponding power consumption.

## 2.3 Quick Start

After unpacking the DAC26EVM and verifying that the board is configured as shown in Table 2–1, install the software.

Place the CD-ROM into the PC's CD-ROM drive. Locate the Setup program on the disk, and run it. The Setup program installs the DAC26EVM software on the PC. Note that if the PC is running Windows™ 2000 or XP, administrator privileges are required to install the software. Follow the instructions that the installer provides.

When the installation is complete, connect a USB cable from the PC to the DAC26EVM. A message may appear that a Human Interface /Audio Device has been connected. Once this connection has been made, launch the DAC26EVM software on the PC.

The software should automatically find the DAC26EVM. When the board is found, the screen shown in Figure 2–1 appears.

Figure 2-1. Default Software Screen

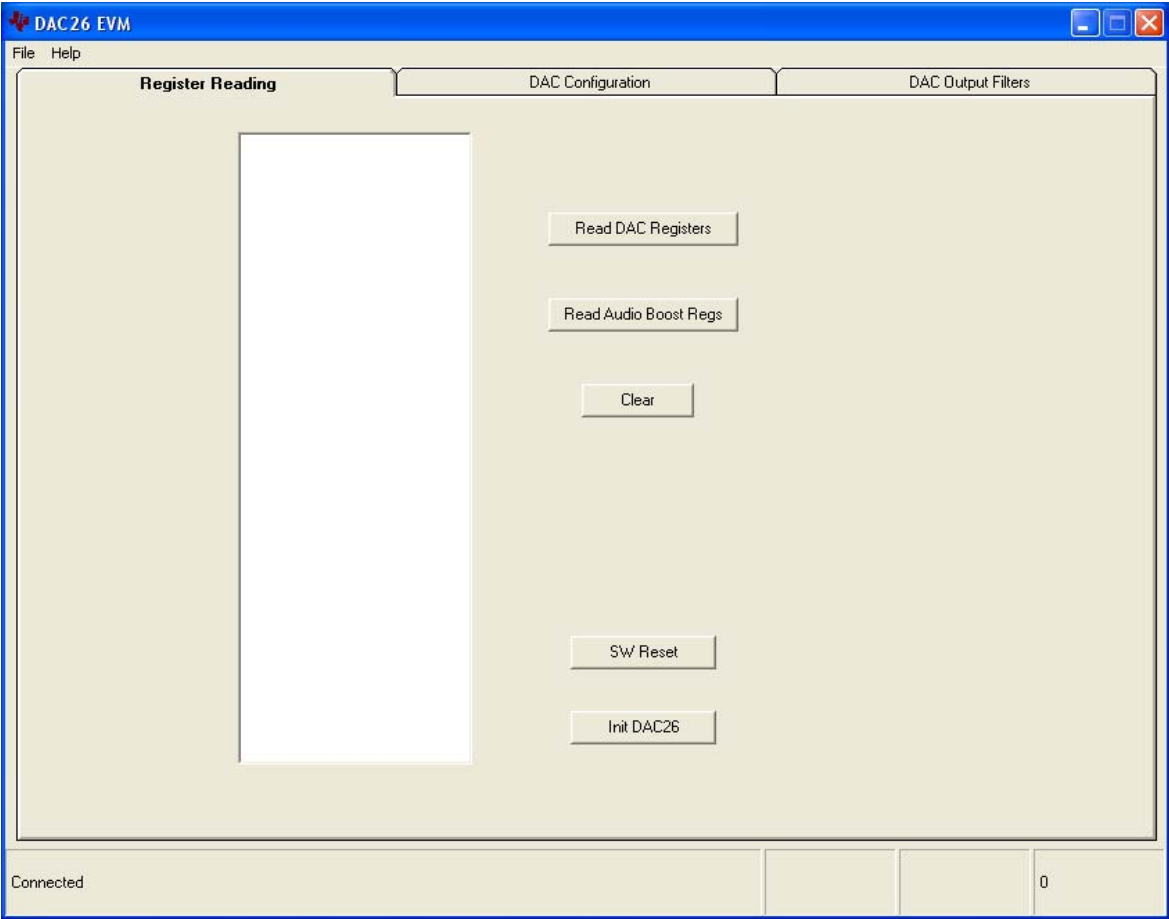



**THIS PAGE INTENTIONALLY LEFT BLANK**



# Operation

---

---

---

---

This chapter describes each function of the DAC26 evaluation kit and how to use the accompanying software to control and use the DAC26.

<b>Topic</b>	<b>Page</b>
<b>3.1 Jumpers</b> .....	<b>3-2</b>
<b>3.2 Switches</b> .....	<b>3-3</b>
<b>3.3 I/O Connectors and Signals</b> .....	<b>3-4</b>
<b>3.4 Circuit Description</b> .....	<b>3-6</b>
<b>3.5 Program Description</b> .....	<b>3-8</b>

## 3.1 Jumpers

Table 3–1 shows the function of each jumper on the EVM.

Table 3–1. Jumper/Function Reference

Reference Designator	Setting	Function	Factory Default	Subsection
JMP1	1 to 2	Differential (MICIN and AUX) microphone input (for sidetone only)	Not installed	3.1.1
JMP2	1 to 2	MIC BIAS from fixed resistor	2 to 3	3.1.2
	2 to 3	MIC BIAS from DAC26		
JMP3	1 to 2	A1 select for EEPROM	Installed	3.1.3
JMP4	1 to 2	PWR select: USB powered	1 to 2	3.1.4
	2 to 3	PWR select: External power supply		
JMP5 – JMP8	Removed	Power is not provided to DAC26	Installed	3.1.5
	Installed	Power is provided to DAC26		
JMP9	1 to 2	DAC26 uses 3.3-V IOVDD	1 to 2	3.1.6
	2 to 3	DAC26 uses 1.8-V IOVDD		

### 3.1.1 Differential Microphone Input

The microphone signal can be input to the DAC26 through the MICIN or AUX, if the signal is single ended. In single-ended mode, JMP1 should be removed. The microphone signal, if differential, can be connected to the DAC26 through J5 and to the DAC26 MICIN and AUX pins. In differential mode, JMP1 should be installed.

### 3.1.2 MIC BIAS Selection

JMP2 selects the microphone bias to come from the DAC26 itself or from an external resistor, R11, which is not installed on the DAC26EVM board. If an external bias is needed, the appropriate size resistor can be soldered into the R11 location on the board and JMP2 set to connect between positions 1 and 2. If MIC BIAS is not required, do not install the jumper top for JMP2 in any position.

### 3.1.3 EEPROM A1 Select

The DAC26EVM loads its firmware from an onboard EEPROM. In order to use the firmware in this EEPROM, its address A2, A1, A0 should be 000b. JMP3 is used to pull the A1 line low so that the EEPROM is selected. When A1 is not low, the EEPROM is not able to interface to the onboard TAS1020B processor.

This jumper can be removed when firmware updates are to be made.

### 3.1.4 Power Supply Selection

The DAC26EVM can be powered from the USB port directly, or an external power supply can be provided through J9 or J10. JMP4 selects between the USB and external power sources.

### 3.1.5 Power Supply Current Measurement

Four jumpers are on the front of the four power supply pins of the DAC26. The jumpers can be replaced by current meters that measure and monitor the currents in the corresponding power supply pins. See the note accompanying Table 2–1.

### 3.1.6 IOVDD Voltage Selection

One of the features of the DAC26 is the flexibility of the digital IO power supply with a range from 1.1 V to 3.6 V. To evaluate this feature, the EVM has the JMP9 jumper for IOVDD selection. If JMP9 is at 1 to 2 position, IOVDD is 3.3 V; if JMP9 is at 2 to 3, IOVDD is 1.8 V; and without JMP9, an extra power supply (1.1 V to 3.6 V) can be connected to IOVDD.

## 3.2 Switches

The onboard SW1 switch gives users the option to select SPI and I<sup>2</sup>S as well as MCLK signal resources. Table 3–2 shows the function of the switch.

Table 3–2. Switch Function Reference

Reference Designator	Setting	Function	Factory Default	Subsection	
SW1	SW1-1	ON	Onboard I <sup>2</sup> S selected	ON	3.2.2
		OFF	External I <sup>2</sup> S selected		
	SW1-2	ON	Onboard MCLK selected	ON	3.2.3
		OFF	External MCLK selected		
	SW1-3	ON	Onboard SPI selected	ON	3.2.1
		OFF	External SPI selected		
	SW1-4	ON	USB Reset connected to DAC26	ON	3.2.4
		OFF	USB Reset not connected to DAC26		

#### 3.2.1 SPI Selection

The SPI bus on the DAC26 provides the main interface between a host-processor and the DAC26 device. The onboard TAS1020B plays the role of the host processor, if SW1-3 is set to the ON position. If an external processor or SPI device is used, set the SW1-3 to the OFF position so as to disable the onboard SPI interface to the TAS1020B and open the DAC26 SPI port to the external SPI bus.

#### 3.2.2 I<sup>2</sup>S Selection

The I<sup>2</sup>S bus on the DAC26 can interface with the onboard host processor, the TAS1020B USB controller, or with other offboard external I<sup>2</sup>S processor or devices. When SW1-1 is set to ON, the manufacturer default, the DAC26 I<sup>2</sup>S is connected to the TAS1020B's I<sup>2</sup>S. Otherwise, if SW1-1 is shifted to OFF, the buffer between the onboard I<sup>2</sup>S port is disabled so that an external I<sup>2</sup>S can communicate with the DAC26 I<sup>2</sup>S port.

### 3.2.3 MCLK Selection

The DAC26 requires a proper MCLK for basic audio DAC functions. The TAS1020B onboard processor generates an 11.2896-MHz frequency to provide the MCLK. If an external MCLK is preferred, SW1-2 should be turned off.

### 3.2.4 USB Reset

A reset signal output from the onboard TAS1020B processor can be used to reset the the DAC26 whenever the TAS1020B is resetting. SW1-4 is used to enable/disable the connection. By default, the connection is enabled. If the processing is not active, the connection to the DAC26 should be disabled by turning off SW1-4.

## 3.3 I/O Connector and Signals

The various connectors on the DAC26EVM are described in this section.

### 3.3.1 Analog Connectors

The DAC26 analog inputs and outputs are routed through these stereo (TIP/RING/SLEEVE) 3,5-mm jacks. Note the polarity of the channel assignments for these connectors.

Table 3–3. Audio Connectors

Reference Designator	Name	Description
J5	Mic In	Microphone input <input type="checkbox"/> tip = mic bias voltage (and MIC input–, if different) <input type="checkbox"/> ring = mic input+ <input type="checkbox"/> sleeve = ground
J6	Headphone Out	Stereo headphone audio outputs <input type="checkbox"/> tip = left channel <input type="checkbox"/> ring = right channel <input type="checkbox"/> sleeve = virtual ground
J7	Line Out	Stereo headphone output with ac coupling <input type="checkbox"/> tip = left channel <input type="checkbox"/> ring = right channel <input type="checkbox"/> sleeve = ground
J13	Loudspeaker	When the DAC26 output drive is in high power mode, an 8-Ω loudspeaker can be connected to J13.

### 3.3.2 USB Interface Connector

Connection to a USB cable from a PC is made through J8, a standard USB type-B receptacle.

Table 3–4. USB Interface Connector

Reference Designator	Description	Pin Number	Signal Name	Function
J8	USB slave connection to PC	1	VCC	+ 5-V supply from USB
		2	D–	– Differential USB signal
		3	D+	+ Differential USB signal
		4	GND	Ground

### 3.3.3 External Power Connectors

While it is most convenient to power the DAC26EVM from the USB bus, external power supplies can be used. The two connectors detailed in Table 3–5 are provided for the external power.

Table 3–5. External Power Connectors

Reference Designator	Description	Pin Number	Signal Name
J9	External power terminal block	1	6 VDC to 10 VDC input
		2	Ground
J10	External power jack	–	6 VDC to 10 VDC input, positive center terminal

### 3.3.4 External Audio Data (I<sup>2</sup>S) Connector

The I<sup>2</sup>S bus, which carries audio data to and from the DAC26, is brought out to header J11 and can be connected to external I<sup>2</sup>S devices if the I<sup>2</sup>S interface to the onboard TAS1020B is disabled.

Table 3–6. Audio Data Connector

Reference Designator	Description	Pin Number	Signal Name
J11	Audio data (I <sup>2</sup> S) connector	1	MCLK
		3	BCLK
		5	LRCLK
		7	Reserved
		9	I2SDOUT
		11	PWD/AWDS
		2,4,6,8,10,12	Ground

### 3.3.5 External SPI Connector

The DAC26 SPI port is brought out to the J12 header. It can be driven by an external source if the onboard microprocessor is disabled.

Table 3–7. External SPI Connector

Reference Designator	Description	Pin Number	Signal Name	Function
J12	External SPI Bus	1	RESET	Reset line
		3	$\overline{SS}$	Slave select for SPI bus.
		5	SCLK	Serial clock for SPI bus.
		7	MOSI	Master out, slave in data line for SPI bus. Data travels to the DAC26 over this line.
		9	MISO	Master in, slave out data line for SPI bus. Data travels from the DAC26 over this line.
		11		Reserved
		2, 4, 6, 8, 10, 12	GND	Ground

### 3.3.6 Analog Input Connector

The auxiliary input can be paired with the MICIN pin to input analog sidetone to the DAC26. The signal is brought onto the EVM board through terminal block J3. It can also come from the differential jack J5. The pinout is shown in Table 3–8.

Table 3–8. Analog Input Connector

Reference Designator	Description	Pin Number	Signal Name	Function
J3	Auxiliary input to the DAC26	1		Reserved
		2		Reserved
		3	AUX	Auxiliary input, 0 V to VREF
		4	GND	Ground

## 3.4 Circuit Description

The DAC26 evaluation kit circuitry consists of a USB microprocessor, power supply circuitry, analog input interfaces, and audio interface circuitry (both analog and digital). These circuits are described in the following sections.

### 3.4.1 USB Microprocessor

The DAC26EVM has a USB interface for connecting to a PC. This connection is made through a TAS1020B streaming audio processor, U5.

The SPI interface to the DAC26 can be controlled from two sources: the external SPI header, J12, or through the onboard microprocessor (U5) via USB. The U5 outputs are enabled only when the supplied firmware is loaded

and the TAS SPI switch SW1-3 is turned on. The firmware resides in the serial EEPROM chip (U2). U5 only loads firmware from U2 when U2's A1 address line is pulled low. To disable firmware loading, A1 must be high, by having JM3 removed.

When the firmware is loaded and active, D2 (a yellow LED) is lit.

If no firmware is loaded, the U3 outputs are in 3-state, allowing the external SPI bus to drive the DAC26 and turn off SW1-3 to ensure the isolation of the TAS1020B from the SPI bus. When the firmware is loaded, the PC software enables the microprocessor to control the SPI bus.

**Do not drive the external SPI bus when the firmware is loaded and the onboard microprocessor is active. Disable the microprocessor by removing JMP3, turn off SW1-3, and cycle power to the DAC26EVM in order to use the external SPI bus.**

Each signal from the SPI inputs is connected directly to the DAC26. As such, signals on these pins must not exceed the power supply voltage of the DAC26, which is 3.3 V on this EVM.

Likewise, the I<sup>2</sup>S signals for the digital audio can be driven either externally by J11 or by the USB audio controller, U5.

**Do not drive the external I<sup>2</sup>S bus when the firmware is loaded and the onboard microprocessor is active. Disable the microprocessor by removing JMP3, turn off SW1-1 and SW1-2, and cycle power to the DAC26EVM in order to use the external I<sup>2</sup>S bus.**

### 3.4.2 Power Supply

Power to the DAC26EVM can be derived directly from the USB interface or externally supplied through the J9 terminal block or the J10 barrel jack connector. Supply voltages of 6 VDC to 10 VDC must be supplied from an external supply. Because it is regulated on the DAC26EVM, this input voltage does not need to be regulated, as long as it falls within this range. D1 prevents damage to the board in the event a power supply is connected in reverse polarity.

U6 regulates the input supply voltage to provide 1.8 V for the DAC26 digital core, or the digital IO power supply if the IOVDD is selected as 1.8 V by JMP9. Also, J3 provides the 3.3 V for the remaining hardware. The regulated supply voltages have LEDs attached that alert the user that the supply is working. D4 (red) is the indicator for the 1.8-V power supply, and D3 (green) is the indicator for the 3.3-V power supply.

### 3.4.3 Analog Outputs

The DAC26 has a built-in headphone amplifier. J6 is the jack for connection to the amplifier and for driving a 16- $\Omega$  load at over 25 mW. Also, under audio output high power mode (see the DAC26 data sheet) an 8- $\Omega$  loudspeaker can be connected to the terminal block J13.

Another audio output jack (J7) is parallel to J6 and provides a secondary connection to the DAC26 built-in headphone amplifier (with ac coupling).

## 3.5 Program Description

After installing the software for the DAC26EVM as described in Section 2.3, you may begin using it to evaluate and develop with the DAC26.

### 3.5.1 Register Reading Screen

The program's interface is a simple, three-tab interface. Clicking on a tab takes you to the functions associated with that tab. The program begins on the Register Reading screen (the default) as shown in Figure 2–1.

The status bar at the bottom of the screen is divided into four sections and shows the status of communication between the PC and the EVM. The first section shows the status of the connection; if an error in communication occurs, an error message appears here, otherwise it looks as shown in Figure 2–1.

When on this screen, there is a window that shows the DAC26 internal control register values. The two buttons next to the window select which group of control registers is required to be read and shown. The clear button clears the window contents. This window is useful for debugging purposes.

Figure 3–1 and Figure 3–2 show the DAC26 control registers and the DAC26 audio base boost filter coefficients, respectively.



Figure 3-1. Register Reading Screen With Control Registers Reading

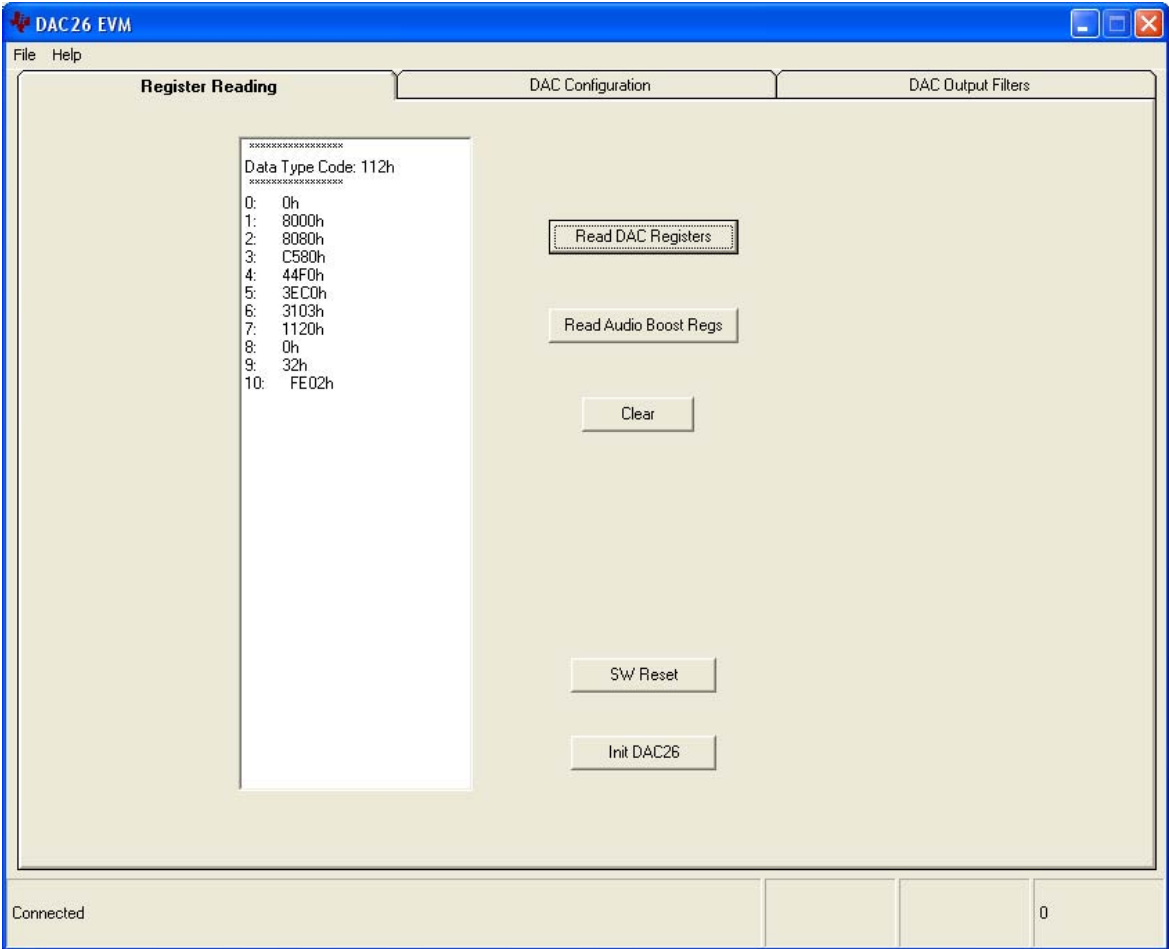
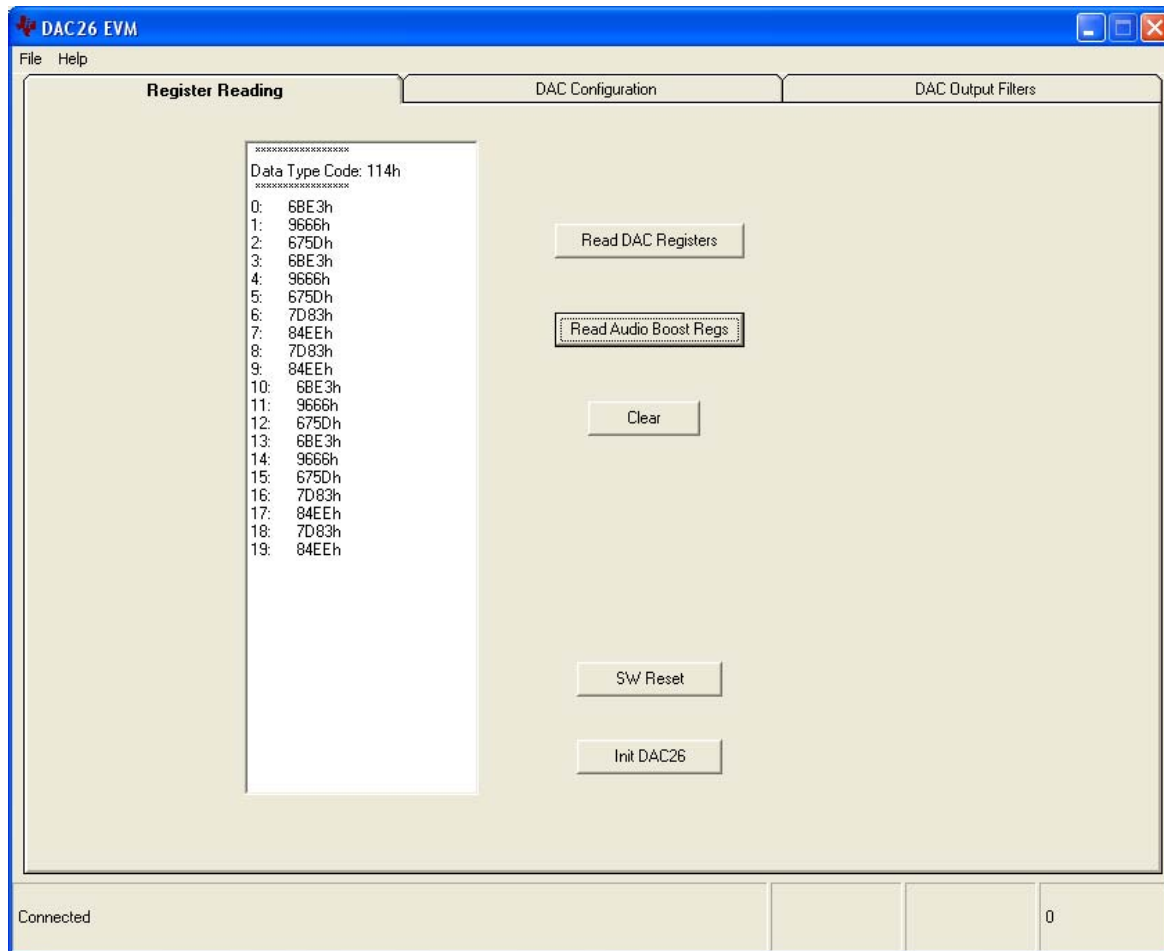

Figure 3–2. Register Reading Screen With Boost Filter Parameters



Two buttons on this screen allow users to reset and reinitialize the DAC26 by clicking them.

By clicking the button **SW Reset**, a software reset is issued. By clicking the button **Init DAC26**, the control registers (for ADC and audio) revert back to the start-up (firmware) default settings.

To bring the DAC26 EVM back to its power-up status, click **SW Reset** and then **Init DAC26**.

### 3.5.2 DAC Configuration Screen

The audio DAC functions of the DAC26 can be accessed using the DAC Configuration screen as shown in Figure 3–3.

Figure 3–3. DAC Configuration Screen

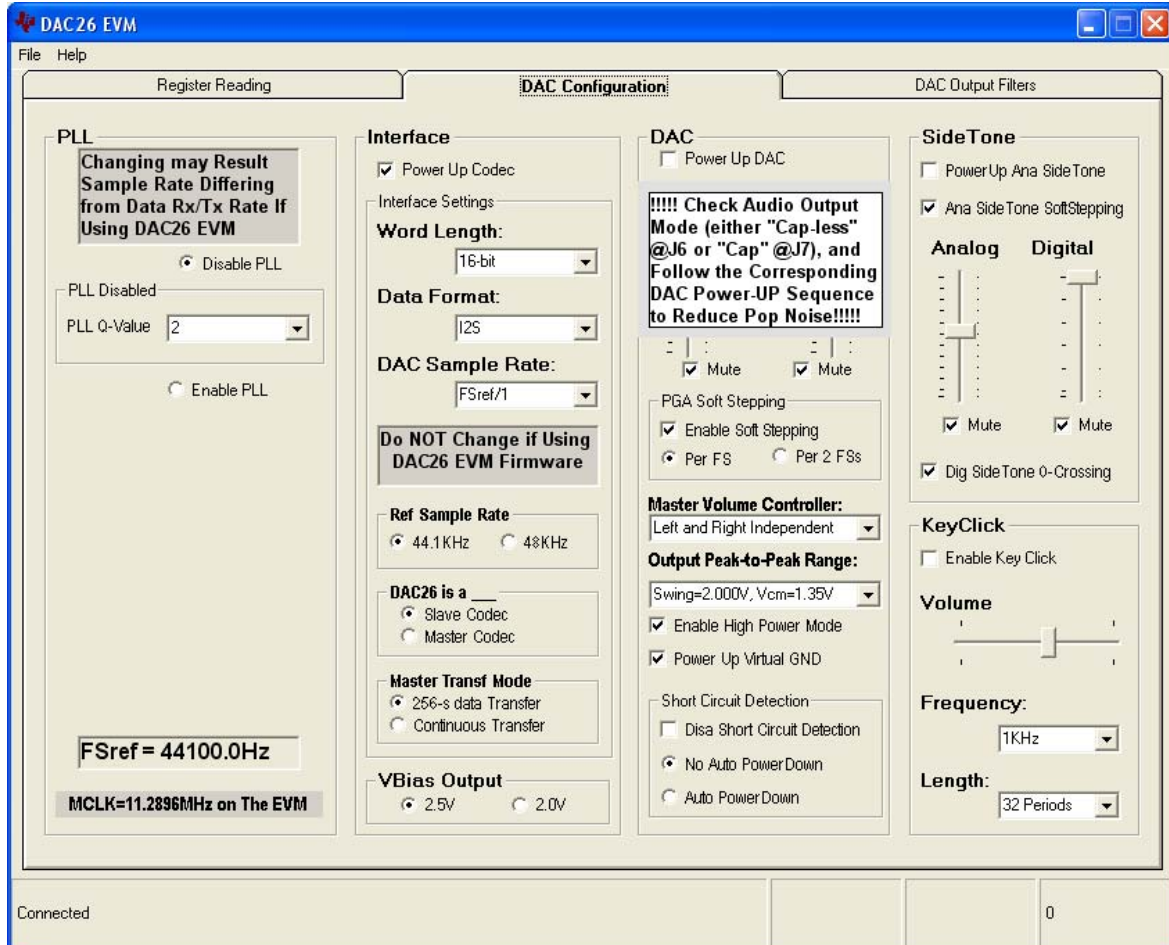

#### 3.5.2.1 Audio PLL Section

On the DAC26, there is an on-chip phase-locked loop (PLL). The PLL can be enabled or disabled, based on the given master clock (MCLK) to the DAC26 and the required reference frequency (FSref) for the codec. For more details on the PLL, see the DAC26 data sheet.

With the EVM board, the MCLK is at 11.2896 MHz, and the codec sample rate is also fixed at 44.1 kHz. So no PLL is necessary.

**CAUTION**  
With the DAC26EVM, changing the PLL setting may cause audio output distortions.

### 3.5.2.2 Interface Section

By checking Power Up Codec in the Interface section, the audio interface is powered up.

In this EVM, the audio codec samples at 44.1 kHz in 16-bit I<sup>2</sup>S mode. Also, the DAC26 codec functions as a slave in the interface. Although the DAC26 device has much more flexibility, this EVM has these values fixed.

Also, the VBias pin output is selectable by checking the corresponding options: either at 2.5 VDC or 2.0 VDC, which provides a bias voltage for using an electret microphone.

### 3.5.2.3 DAC Section

The DAC26 audio DAC can be powered on by clicking on the power-up DAC box. By default, the DAC is powered off.

Before a DAC power on, make sure to check the DAC output mode on the EVM board. If the audio output is connected to J6 or J13, the *virtual GND* should be powered up before the DAC powers up. Otherwise, if the audio output is connected to J7 ( AC coupled plug), the *virtual GND* should be powered down before power up.

The stereo audio volumes can be controlled by the left (L) and right (R) volume control slides in three different ways, selectable through setting the master volume controller: 1) independent, 2) right channel controlled, or 3) left channel controlled.

The DAC's PGA gain can be changed in *soft stepping* either 0.5-dB per one sample, or 0.5-dB per 2 samples.

The audio DAC's output swing range can be set from the list in the Output Peak-to-Peak Range pulldown menu. See the DAC26 data sheet to find out the range. Note that the output peak-to-peak range is related to the analog driver power supply voltage.

By checking the Headphone Amp Enable box, the amplifier is enabled, which can directly be connected to a 16-Ω load. Otherwise, the headphone driver is bypassed, and the device can have a load of 10 kΩ.

By checking the Power Up Virtual GND box, the virtual ground for the headphone output is powered up. The virtual ground should be powered up/down according to the DAC output mode. If the DAC output is in capacitor-decoupling mode, the virtual group can be powered down; otherwise, the DAC output is in capacitor-less mode, and the virtual ground should be powered up.

### 3.5.2.4 Sidetone Section

The DAC26 has an analog sidetone and a digital sidetone circuit. The audio output of the DAC26 includes a mix of the DAC and the sidetone channels, in proportion to their respective volume settings.

The analog sidetone is enabled when the PowerUp AnaSideTone box is checked, and available only if the single-ended MICIN or AUX Input Select is

selected as input. Its volume can be adjusted by the analog volume control slider, ranging from 12 dB to –34.5 dB in 0.5-dB steps. The analog sidetone is muted when the Mute box under the slider is checked. Additionally, the analog sidetone volume change can be in soft-stepping mode if the corresponding box is checked.

The DAC26 digital sidetone has three settings. The volume is controlled by the digital slider, which changes from 0 dB to –48 dB in steps of 1.5 dB. The digital sidetone can be muted by checking the mute box under the volume control slider. The gain change is implemented with zero crossover, when enabled by checking the box below the sliders, and a possible pop sound may be avoided or reduced.

#### **3.5.2.5 Keyclick Section**

When the Enable Key Click box is checked, a clicking sound is heard whenever a setting on the DAC configuration and DAC output filter tabs is changed.

The volume, frequency, and duration (length) of this keyclick can be adjusted using the corresponding slider and selectors shown in Figure 3–3.

### **3.5.3 DAC Output Filters Screen**

The Audio Effects Filters screen displays all of the coefficients for the audio effects filters of the DAC26, including the bass-boost and other filters, the de-emphasis filters and the power-up *pop* noise reduction functions. This screen is shown in Figure 3–4.

Figure 3–4. DAC Output Filter Screen

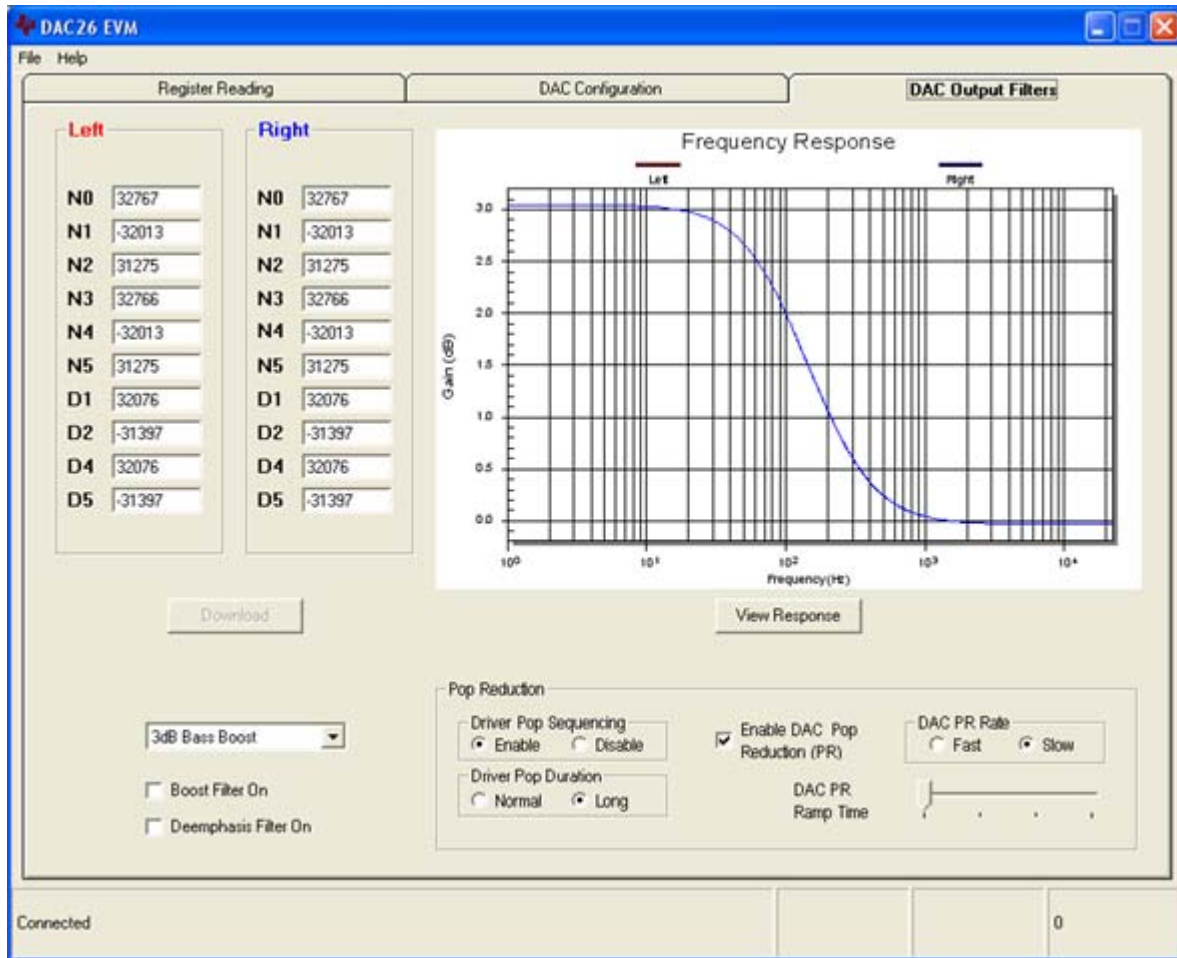

Different filter coefficients can be loaded for left and right channels, though usually these are set the same. Six *preconfigured* filters are selectable using the drop-down list box of this screen. Selecting one of these updates the coefficients and causes the graph of the filter response to update. However, nothing is loaded into the DAC26 until the *Download* button is pressed.

If changes are made to coefficient values directly, the response can be viewed on the graph by pressing the *View Response* button. It is recommended that you view the response before downloading values to the DAC26, as some values can cause clipping or oscillation of the filter. The filter equation is described in the DAC26 data sheet.

Checking the Boost Filter On box enables the filter.

The DAC26 provides another digital filter, the de-emphasis filter, for the audio DAC. Checking the Deemphasis Filter On box enables the filter.

Moreover, to reduce the DAC26's power-up pop noise, two pop-reduction functions were added to the DAC26 and are selectable on this screen. They are the audio output driver pop-reduction and the audio DAC pop-reduction. See the DAC26 data sheet for the details of the pop-reduction features.

# Physical Description

---

---

---

---

This chapter contains the component locations, bill of materials, and the schematics.

<b>Topic</b>	<b>Page</b>
<b>4.1 Component Locations</b> .....	<b>4-2</b>
<b>4.2 Bill of Materials</b> .....	<b>4-3</b>
<b>4.3 Schematics</b> .....	<b>4-6</b>

### 4.1 Component Locations

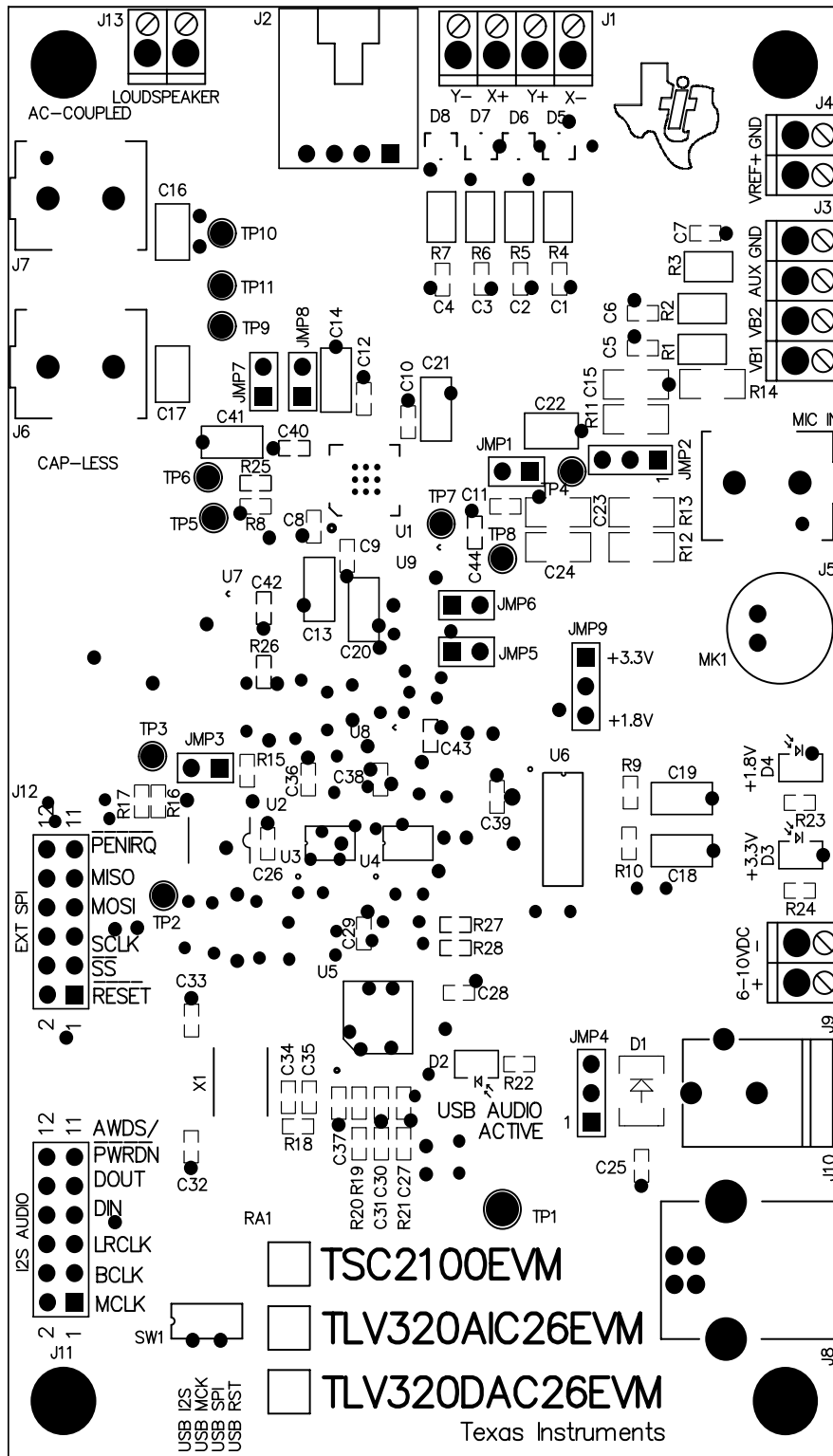



## 4.2 Bill of Materials

Item No.	Qty	Value	Ref Des	Description	Vendor	Part Number
1	1	0R0	R3	1/10W 5% Chip resistor	Panasonic	ERJ-6GEY0R00V
Not Installed	4	0R0	R4, R5, R6, R7	1/10W 5% Chip resistor	Panasonic	ERJ-6GEY0R00V
2	1	0R0	R12	1/4W 5% Chip resistor	Panasonic	ERJ-8GEY0R00V
3	1	10R	R23	1/16W 5% Chip resistor	Panasonic	ERJ-3GEYJ100V
4	2	27R4	R20, R21	1/16W 1% Chip resistor	Panasonic	ERJ-3EKF27R4V
5	1	220R	R24	1/16W 5% Chip resistor	Panasonic	ERJ-3GEYJ221V
Not Installed	2	220R	R1, R2	1/8W 5% Chip resistor	Panasonic	ERJ-6GEYJ221V
6	1	649R	R22	1/16W 1% Chip resistor	Panasonic	ERJ-3EKF6490V
7	1	680R	R14	1/4W 5% Chip resistor	Panasonic	ERJ-8GEYJ681V
8	1	1.5 K	R19	1/16W 5% Chip resistor	Panasonic	ERJ-3GEYJ152V
9	1	2.2 K	R13	1/4W 5% Chip resistor	Panasonic	ERJ-8GEYJ222V
10	3	2.7 K	R26, R27, R28	1/10W 5% Chip resistor	Panasonic	ERJ-3GEYJ272V
11	4	3.09 K	R15, R16, R17, R18	1/16W 1% Chip resistor	Panasonic	ERJ-3EKF3091V
12	4	100 K	R8, R9, R10, R25	1/16W 5% Chip resistor	Panasonic	ERJ-3GEYJ104V
Not Installed	1		R11	1/10W 5% Chip resistor	Panasonic	
13	1	10 K	RA1	1/8W Quad Isolated resistor array	CTS Corporation	744C083103JTR
14	2	33 pF	C32, C33	50 V Ceramic chip capacitor, $\pm 5\%$ , NPO	Panasonic	ECJ-1VC1H330J
15	2	47 pF	C30, C31	50 V Ceramic chip capacitor, $\pm 5\%$ , NPO	Panasonic	ECJ-1VC1H470J
16	1	100 pF	C34	50 V Ceramic chip capacitor, $\pm 5\%$ , NPO	Panasonic	ECJ-1VC1H101J
17	1	1000 pF	C35	50 V Ceramic chip capacitor, $\pm 5\%$ , NPO	Panasonic	ECJ-1VC1H102J
18	6	0.1 $\mu$ F	C8, C9, C11, C12, C25, C40	16 V Ceramic chip capacitor, $\pm 10\%$ , X7R	Panasonic	ECJ-1VB1C104K
19	1	0.1 $\mu$ F	C24	16 V Ceramic chip capacitor, $\pm 10\%$ , X7R	Panasonic	ECJ-3VB1C104K
Not Installed	3	0.1 $\mu$ F	C5, C6, C7	16 V Ceramic chip capacitor, $\pm 10\%$ , X7R	Panasonic	ECJ-1VB1C104K
20	1	0.33 $\mu$ F	C39	6.3 V Ceramic chip capacitor, $\pm 10\%$ , X5R	Panasonic	ECJ-1VB0J334K
21	10	1 $\mu$ F	C26, C27, C28, C29, C36, C37, C38, C42, C43, C44	6.3 V Ceramic chip capacitor, $\pm 10\%$ , X5R	Panasonic	ECJ-1VB0J105K

Bill of Materials

Item No.	Qty	Value	Ref Des	Description	Vendor	Part Number
22	7	10 $\mu$ F	C13, C14, C15, C18, C19, C20, C41	6.3 V Ceramic chip capacitor, $\pm$ 10%, X5R	Panasonic	ECJ-3YB0J106K
23	3	47 $\mu$ F	C16, C17, C22	6.3 V Ceramic chip capacitor, $\pm$ 20%, X5R	Panasonic	ECJ-4YB0J476M
Not Installed	1		C23	16 V Ceramic chip capacitor, $\pm$ 10%, X7R	Panasonic	
Not Installed	4	0.01 $\mu$ F	C1, C2, C3, C4	16 V Ceramic chip capacitor, $\pm$ 10%, X7R	Panasonic	ECJ-1VB1C103K
Not Installed	1	0.1 $\mu$ F	C10	16 V Ceramic chip capacitor, $\pm$ 10%, X7R	Panasonic	ECJ-1VB1C104K
Not Installed	1	10 $\mu$ F	C21	6.3 V Ceramic chip capacitor, $\pm$ 10%, X5R	Panasonic	ECJ-1VB0J106K
24	1		D1	50 V, 1A, Diode MELF SMD	Micro Commercial Components	DL4001
25	1		D2	Yellow light emitting diode	Lumex	SML-LX0603YW-TR
26	1		D3	Green light emitting diode	Lumex	SML-LX0603GW-TR
27	1		D4	Red light emitting diode	Lumex	SML-LX0603IW-TR
Not Installed	4		D5, D6, D7, D8	Schottky barrier diode, series configuration	Zetex	BAT54STA
28	1		MK1	Omnidirectional Microphone Cartridge	Knowles Acoustics	MD9745APZ-F
29	1		X1	6 MHz Crystal SMD	Epson	MA-505 6.000M-C0
30	1		U1	Stereo audio CODEC	Texas Instruments	TLV320AIC26IRHB
31	1		U5	USB streaming controller	Texas Instruments	TAS1020BPFB
32	1		U6	3.3 V/1.8 V dual output LDO regulator	Texas Instruments	TPS767D318PWP
33	2		U3, U4	Quad 3-state buffers	Texas Instruments	SN74LVC125APW
34	3		U7, U8, U9	Single IC buffer driver with open drain O/P	Texas Instruments	SN74LVC1G07DBVR
35	1		U2	64K 2-Wire Serial EEPROM I <sup>2</sup> C	Microchip	24LC64I/SN
36	1		N/A	TSC2100EVM/AIC26EVM PWB	Texas Instruments	6444324
37	10		TP2, TP3, TP4, TP5, TP6, TP7, TP8, TP9, TP10, TP11	Miniature test point terminal	Keystone Electronics	5000
38	1		TP1	Multipurpose test point terminal	Keystone Electronics	5011
Not Installed	1		J2	4 Pin right angle latching header	Tyco Electronics/AMP	103634-3

Item No.	Qty	Value	Ref Des	Description	Vendor	Part Number
39	1		J8	USB Type B slave connector thru-hole	Mill-Max	897-30-004-90-000000
40	2		J9, J13	2 Position terminal block	On Shore Technology	ED555/2DS
Not Installed	1		J4	2 Position terminal block	On Shore Technology	ED555/2DS
41	1		J3	4 Position terminal block	On Shore Technology	ED555/4DS
Not Installed	1		J1	4 Position terminal block	On Shore Technology	ED555/4DS
42	1		J10	2,5 mm Power connector	CUI Stack	PJ-102B
43	3		J5, J6, J7	3,5 mm Stereo audio jack SMT	CUI Stack	SJ-3515-SMT-1
44	2		J11, J12	12 Pin double row header (2x6) 0.1"	Samtec	TSW-106-07-L-D
45	2		JMP1, JMP3	2 Position Jumper , 0.1" spacing	Samtec	TSW-102-07-L-S
46	3		JMP2, JMP4, JMP9	3 Position Jumper , 0.1" spacing	Samtec	TSW-103-07-L-S
47	4		JMP5, JMP6, JMP7, JMP8	Bus wire		
48	1		SW1	SMT, Half-pitch 4 position switch	C & K Division, ITT	TDA04H0SK1
49	5		N/A	Jumper plug	Samtec	SNT-100-BK-T
50	4		N/A	0.25" x 0.625" Hex 4-40 threaded standoff	Keystone Electronics	1808
51	4		N/A	Pan head machine screw 4-40 x 1/2" Phillips	Building Fasteners	PMS 440 0050 PH

### **4.3 Schematics**

Schematic diagrams of the DAC26EVM showing the DAC26 connections and the USB and connectors are shown on the following pages.

Revision History		
REV	ECN Number	Approved

PLEASE NOTE:  
Components within dashed box are not included on the AIC26 and DAC26 versions of the board.

D5 through D8 are not installed, but can be added for extra ESD protection, or for reducing touch panel noise.

C1 through C7 are not installed, but can be added for noise filtering.

Components marked with \*\* are not included on the DAC26 version of the board.

CAUTION!  
Do not connect the Loudspeaker and Line Out jacks at the same time.

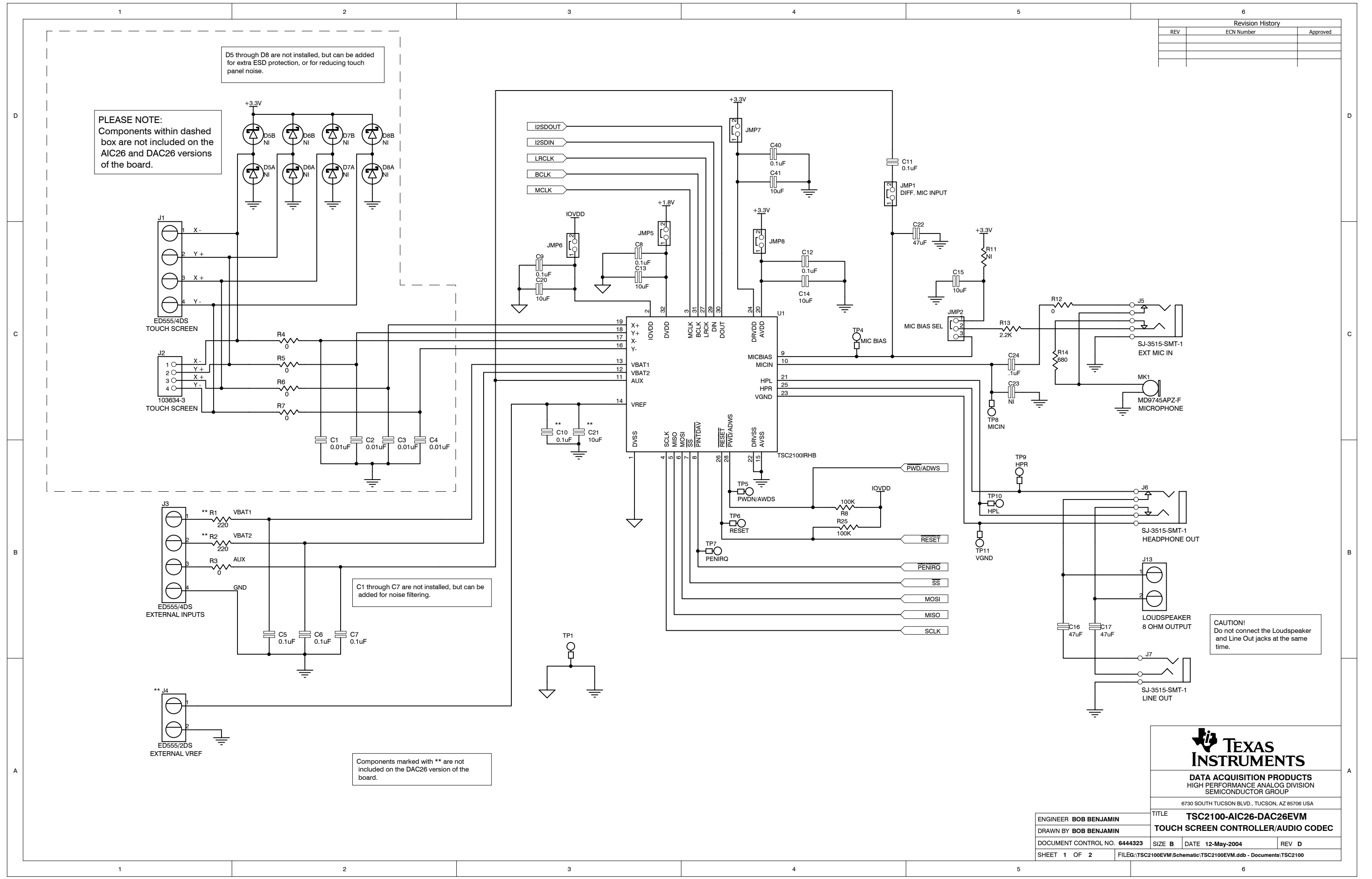

**TEXAS INSTRUMENTS**  
 DATA ACQUISITION PRODUCTS  
 HIGH PERFORMANCE ANALOG DIVISION  
 SEMICONDUCTOR GROUP  
 6730 SOUTH TUCSON BLVD., TUCSON, AZ 85706 USA

ENGINEER <b>BOB BENJAMIN</b>	TITLE <b>TSC2100-AIC26-DAC26EVM</b>
DRAWN BY <b>BOB BENJAMIN</b>	<b>TOUCH SCREEN CONTROLLER/AUDIO CODEC</b>
DOCUMENT CONTROL NO. <b>6444323</b>	SIZE <b>B</b> DATE <b>12-May-2004</b> REV <b>D</b>
SHEET <b>1</b> OF <b>2</b>	FILEG:\TSC2100EVM\Schematic\TSC2100EVM.ddb - Documents\TSC2100

