



# TAOGLAS®



# Datasheet

## Shockwave

**Part No:**  
TLS.01.1F21

### **Description:**

Shockwave Wideband 5G/4G Direct Mount External Antenna  
With N Type(F) connector

### **Features:**

Applicable for 5G/4G cellular bands  
600-6000MHz Wideband Operational  
Over 45% efficiency and 2.3 dBi gain  
Mechanically robust for indoor/outdoor applications  
Height: 79.45mm (3.13")  
Diameter: 42mm (1.65")  
IP67 Waterproof  
N type(F) connector  
RoHS & Reach Compliant

1. Introduction	3
2. Specifications	4
3. Antenna Characteristics	6
4. Radiation Patterns	8
5. Mechanical Drawing	18
6. Installation Guide	19
7. Packaging	20
<hr/>	
Changelog	21

Taoglas makes no warranties based on the accuracy or completeness of the contents of this document and reserves the right to make changes to specifications and product descriptions at any time without notice. Taoglas reserves all rights to this document and the information contained herein. Reproduction, use or disclosure to third parties without express permission is strictly prohibited.



# 1. Introduction



The Shockwave TLS.01.1F21 is a permanent mount, waterproof, external 5G/4G cellular operating at the wideband 600-6000MHz frequency with an N type Female direct mount connector. It has been designed to be used on a Ground Plane. It can be used in mobile and fixed applications for 5G/4G wireless such as:

- Public safety
- HD Video Streaming
- Utilities and Smart Cities
- Fleet Management
- Agricultural
- Industrial

This antenna has superior performance over wide-bands compared to traditional whip antennas. Up to 90% efficiency and with a minimum 2.3dBi peak gain over all cellular bands result when mounted on a 30x30 cm ground plane. Stable radiation patterns over low angles provides consistent gain in the horizontal plane, meaning that it is especially suitable for cellular applications.

A unique indent tab on the base of the antenna allows a wrench to be used to solidly lock the antenna on top of its mounting location, where an N type female connector juts out from a metal panel. Waterproof O-rings around the bottom base prevent water from leaking under the antenna.

The TLS.01 antenna is IP67 waterproof resistant against high pressure water jets in commercial cleaning environments, which makes the antenna ideal for 5G/4G/3G/Cat M/NB-IoT applications either in indoor or in harsh outdoor environments. For more information contact your regional Taoglas customer support team.

## 2. Specifications

Electrical								
Band	Frequency (MHz)	Efficiency (%)	Average Gain (dB)	Peak Gain (dBi)	Impedance	Max Input Power	Polarization	Radiation Pattern
5G NR/4G Band 71	617~698	46.5	-3.2	-1	50 Ω	100W	Vertical	Omni-Directional
4G/3G Band 12,13,14,17,28,29	698~806	95.2	-0.2	3.1				
4G/3G/NB-IoT/Cat M Band 5,8,18,19,20,26,27	824~960	84.5	-0.7	3.2				
5G NR/4G Band 21,32,74,75,76	1427~1518	71.9	-1.4	2.9				
4G/3G Band 1,2,3,4,9,23,25,35,39,66	1710~2200	65.5	-1.8	2.7				
4G/3G Band 7,38,41	2490~2690	62.7	-2	3.4				
5G NR/4G Band 22,42,48,77,78	3300~3800	41.1	-4.1	2.5				
LTE5200/ Wi-Fi 5800	5150~5925	45.9	-3.4	5.3				

\*Measured on 30\*30cm ground plane

Mechanical	
Dimension (mm)	Height: 79.45mm(3.13") ; Diameter : 42mm(1.65")
Connector	Direct Mount N type (F)
Housing Material	UV Resistant ABS
Base Material	Nickel Plated Zinc Alloy
Weight (g)	130
Rec. Torque for Mounting	4.018 N·m
Max. Torque for Mounting	9.8 N·m
Waterproof Rating	IP67
Operation Temperature	-40°C to 85°C
Humidity	Non-condensing 65°C 95% RH
Housing Rating	IK10

5G/4G Bands			
Band Number	5G NR / FR1 / LTE / LTE-Advanced / WCDMA / HSPA / HSPA+ / TD-SCDMA / Cat M / NB-IoT		
	Uplink	Downlink	Covered
1	UL: 1920 to 1980	DL: 2110 to 2170	✓
2	UL: 1850 to 1910	DL: 1930 to 1990	✓
3	UL: 1710 to 1785	DL: 1805 to 1880	✓
4	UL: 1710 to 1755	DL: 2110 to 2155	✓
5	UL: 824 to 849	DL: 869 to 894	✓
7	UL: 2500 to 2570	DL: 2620 to 2690	✓
8	UL: 880 to 915	DL: 925 to 960	✓
9	UL: 1749.9 to 1784.9	DL: 1844.9 to 1879.9	✓
11	UL: 1427.9 to 1447.9	DL: 1475.9 to 1495.9	✓
12	UL: 699 to 716	DL: 729 to 746	✓
13	UL: 777 to 787	DL: 746 to 756	✓
14	UL: 788 to 798	DL: 758 to 768	✓
17	UL: 704 to 716	DL: 734 to 746	✓
18	UL: 815 to 830	DL: 860 to 875	✓
19	UL: 830 to 845	DL: 875 to 890	✓
20	UL: 832 to 862	DL: 791 to 821	✓
21	UL: 1447.9 to 1462.9	DL: 1495.9 to 1510.9	✓
22	UL: 3410 to 3490	DL: 3510 to 3590	✓
23	UL: 2000 to 2020	DL: 2180 to 2200	✓
24	UL: 1625.5 to 1660.5	DL: 1525 to 1559	✓
25	UL: 1850 to 1915	DL: 1930 to 1995	✓
26	UL: 814 to 849	DL: 859 to 894	✓
27	UL: 807 to 824	DL: 852 to 869	✓
28	UL: 703 to 748	DL: 758 to 803	✓
29	UL: -	DL: 717 to 728	✓
30	UL: 2305 to 2315	DL: 2350 to 2360	✓
31	UL: 452.5 to 457.5	DL: 462.5 to 467.5	✗
32	UL: -	DL: 1452 - 1496	✓
35		1850 to 1910	✓
38		2570 to 2620	✓
39		1880 to 1920	✓
40		2300 to 2400	✓
41		2496 to 2690	✓
42		3400 to 3600	✓
43		3600 to 3800	✓
48		3550 to 3700	✓
66	UL: 1710-1780	DL: 2110-2200	✓
71		617 to 698	✓
74/75/76		1427 to 1518	✓
77		3300 to 4200	✓
78		3300 to 3800	✓
79		4400 to 5000	✓

### 3. Antenna Characteristics

#### 3.1 Return Loss

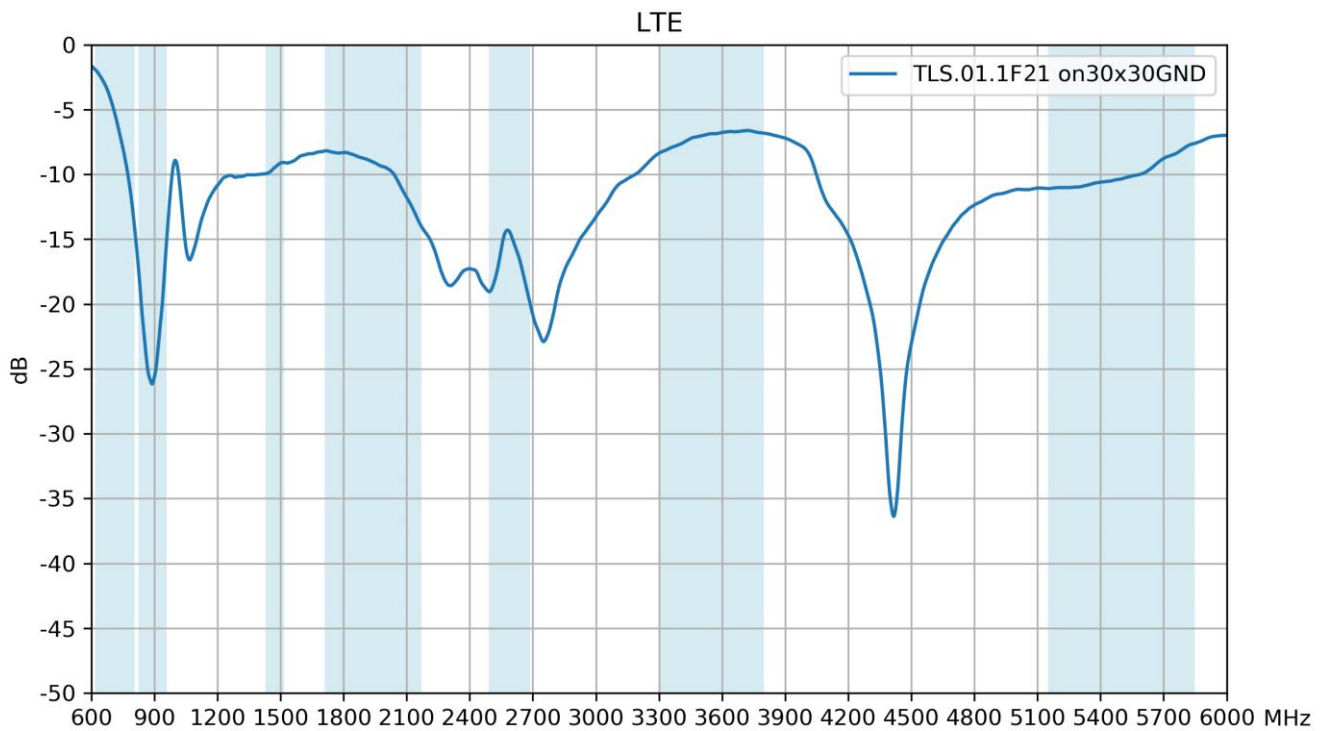

#### 3.2 Efficiency

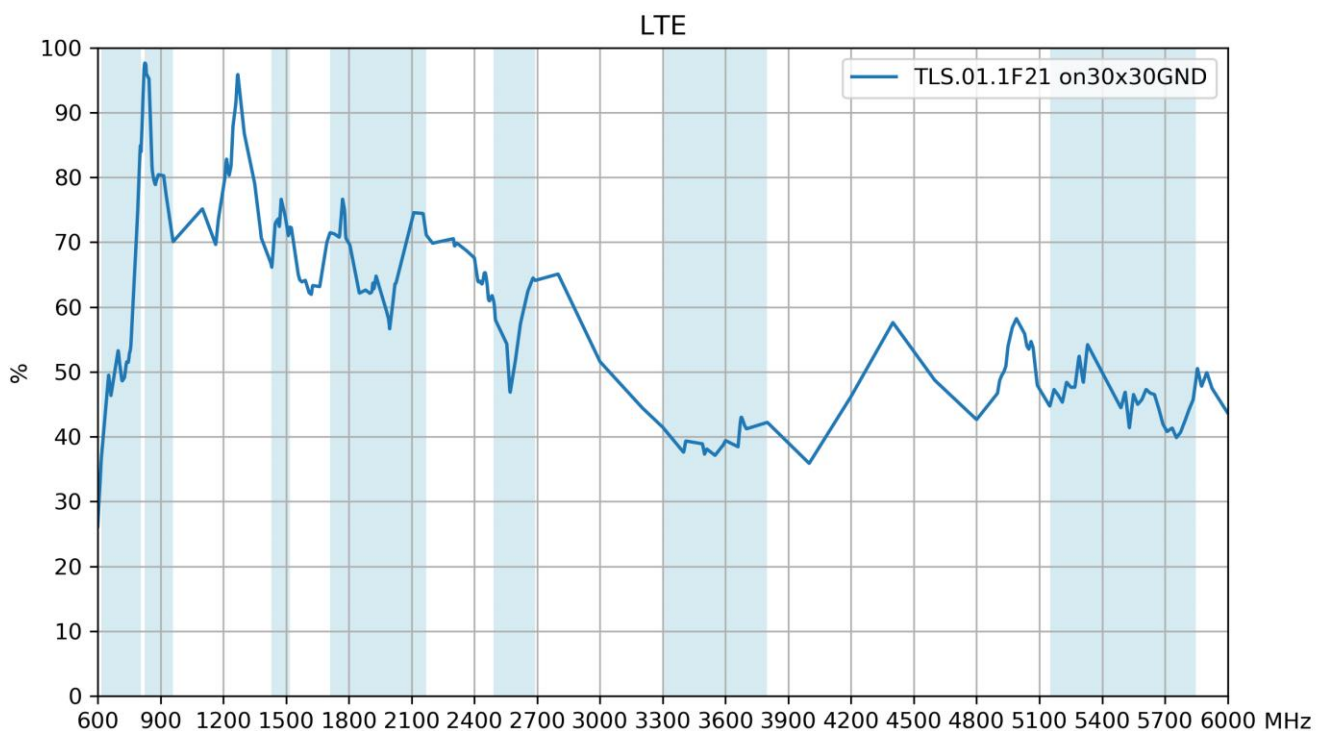

### 3.3 Average Gain

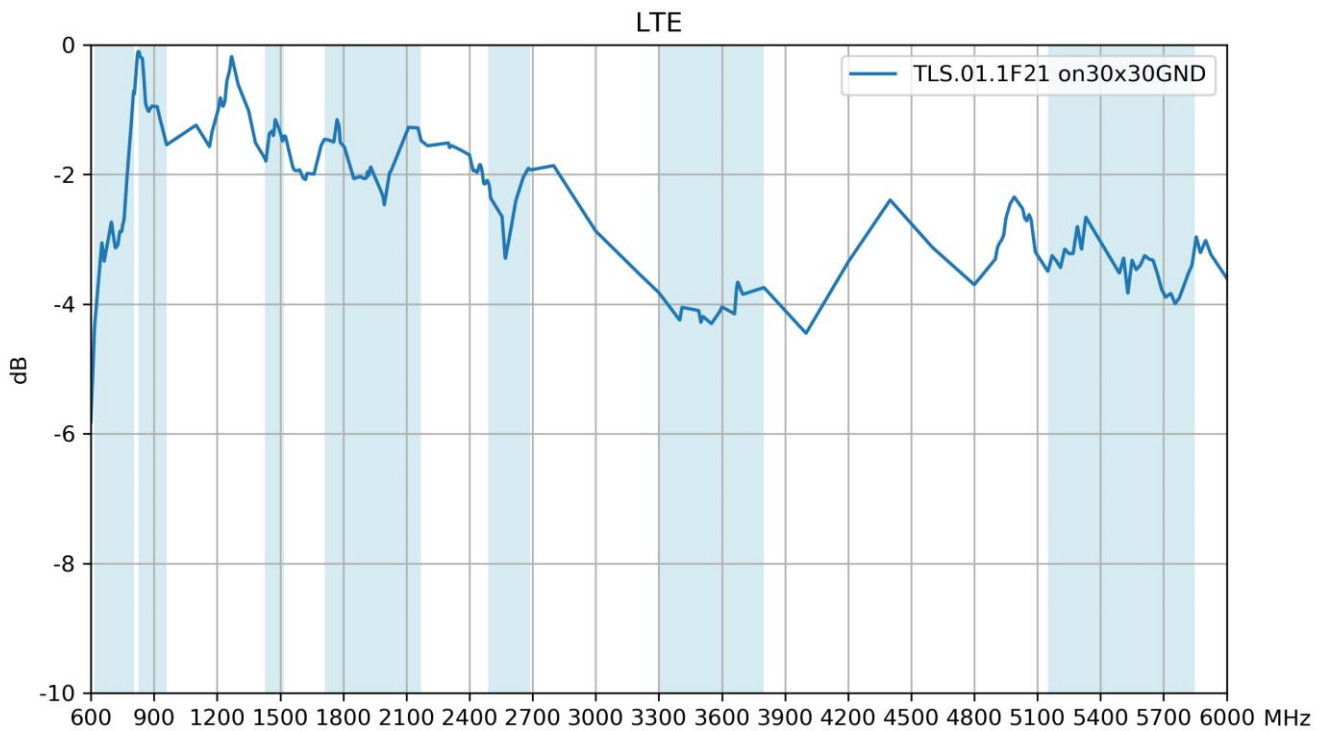

### 3.4 Peak Gain

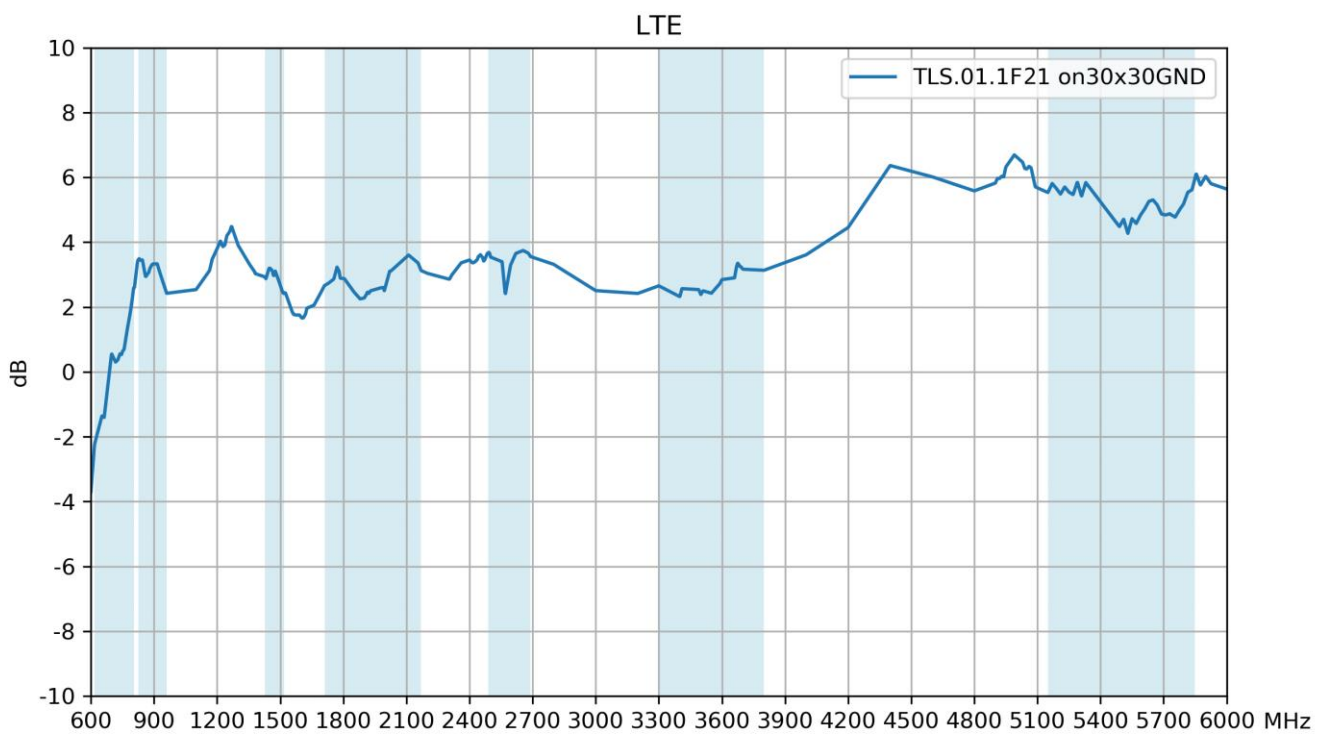

## 4. Radiation Patterns

### 4.1 Test Setup

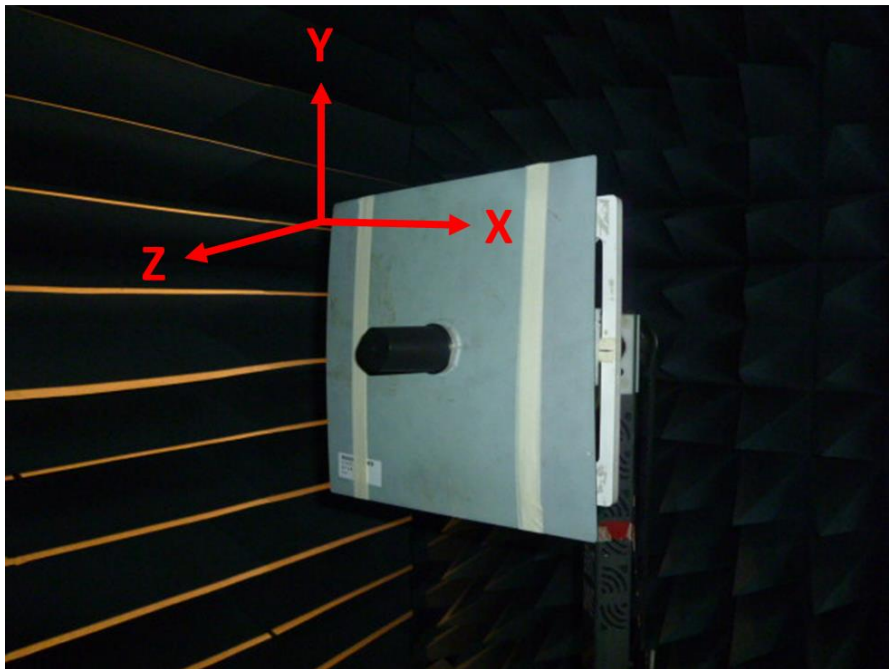

On 30\*30cm Ground Plane



4.2 3D and 2D Radiation Patterns

652MHz

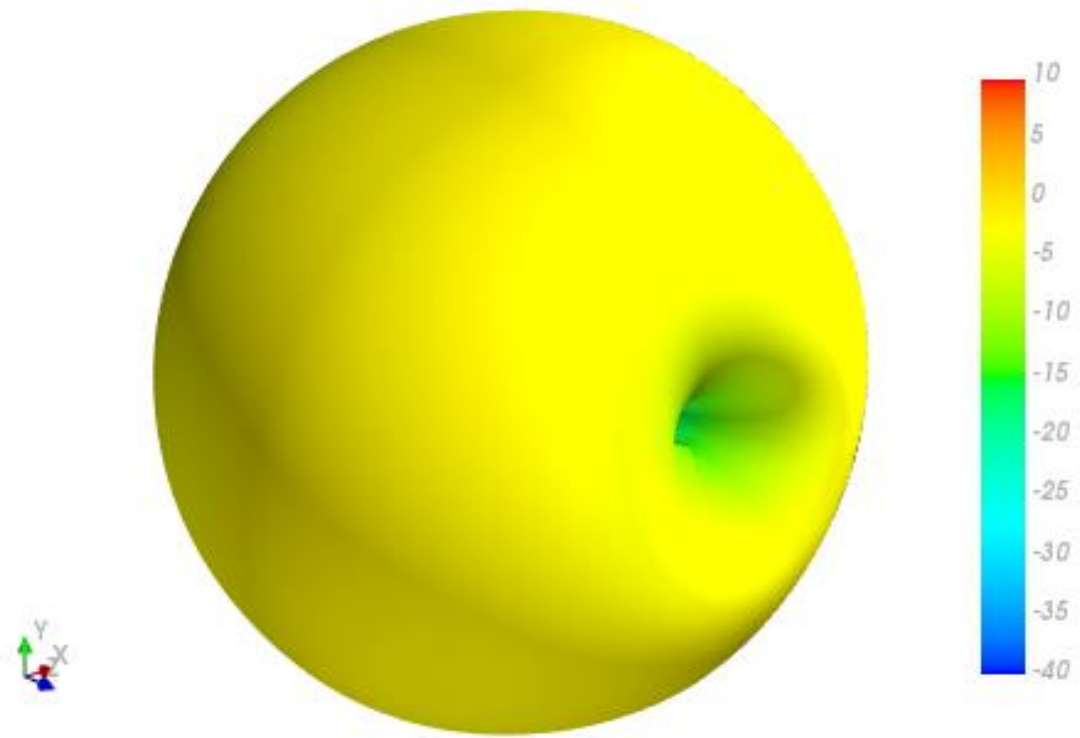

XY Plane

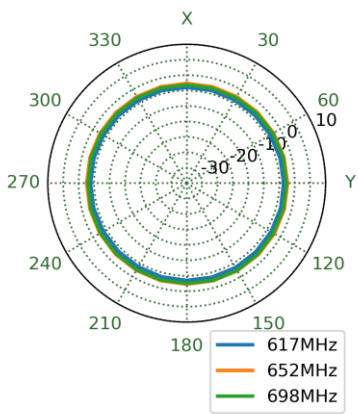

XZ Plane

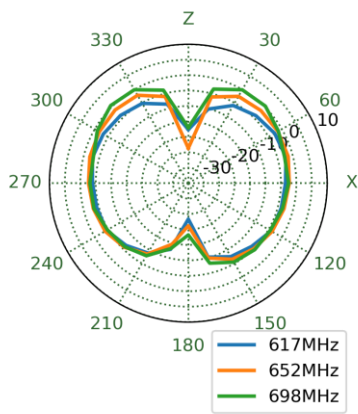

YZ Plane

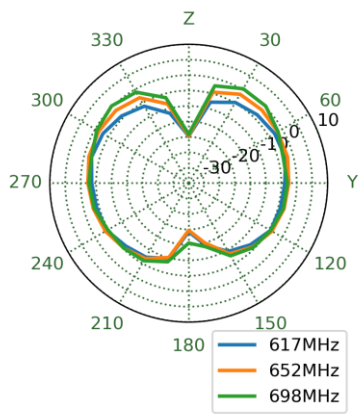

751MHz

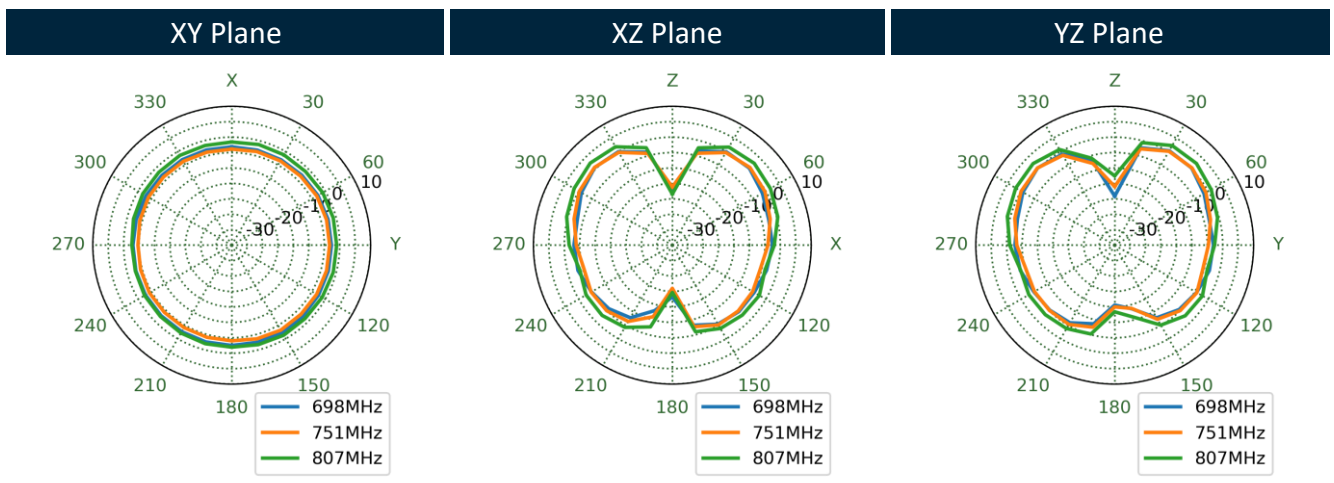
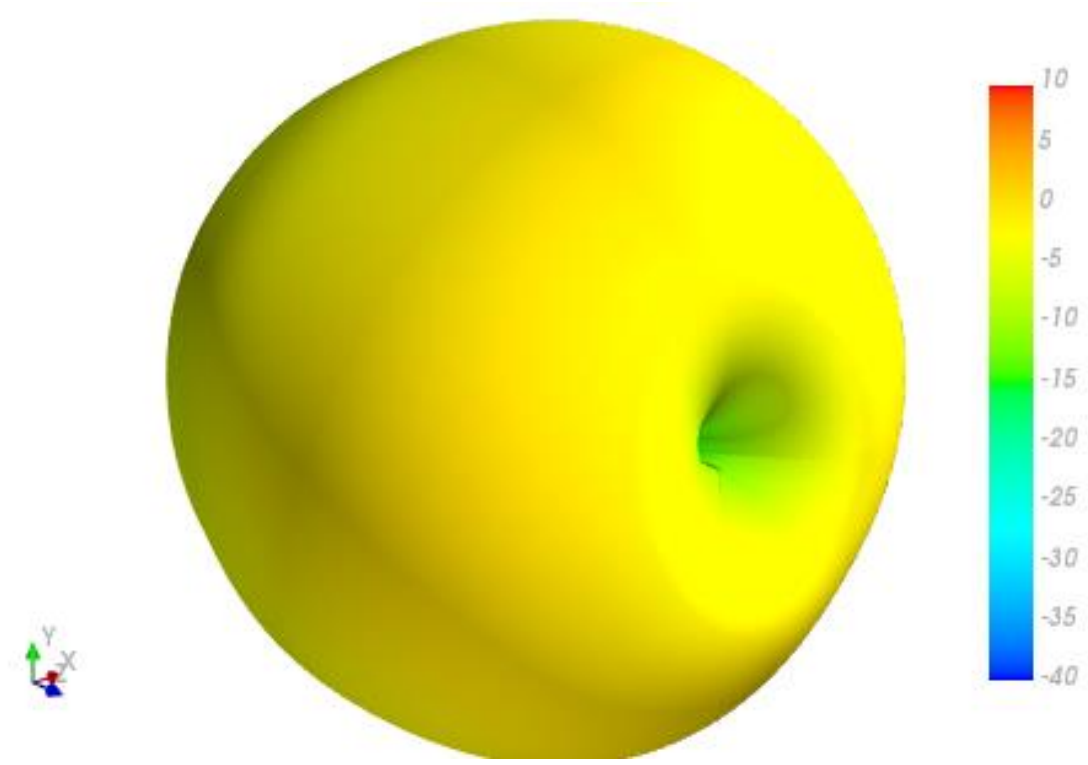

890MHz

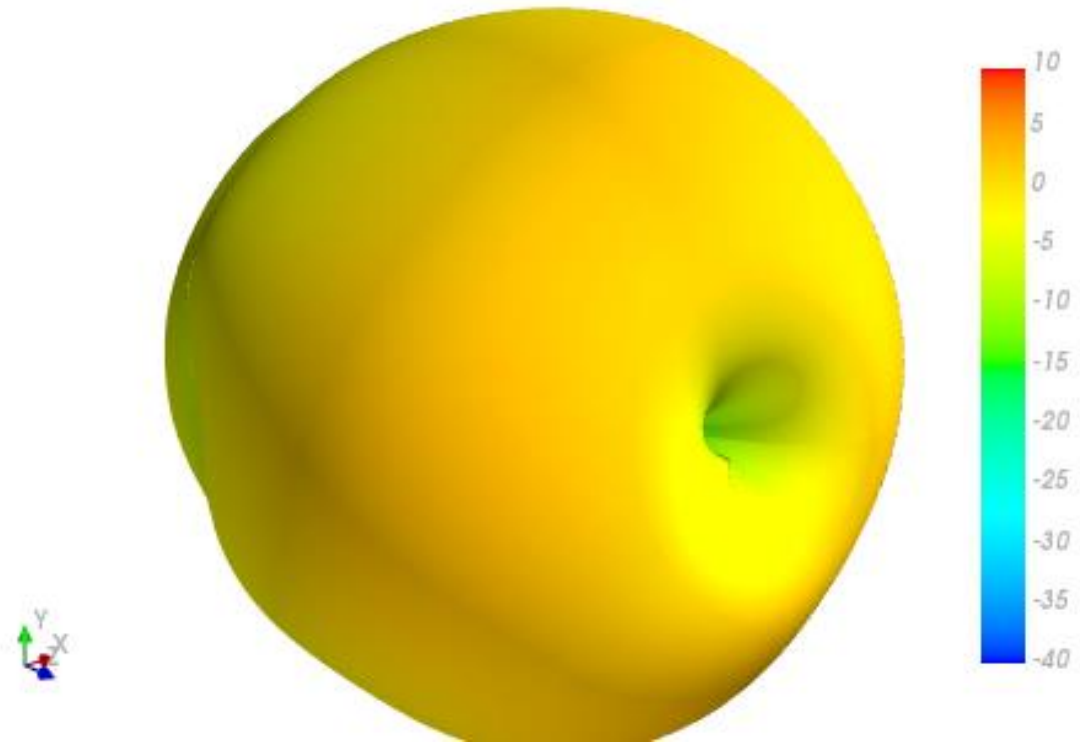

XY Plane

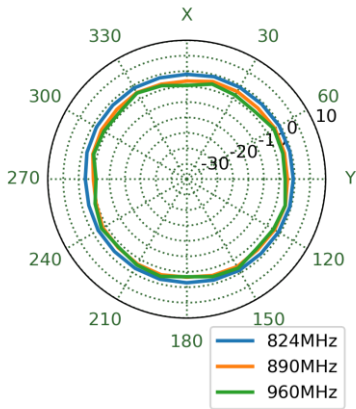

XZ Plane

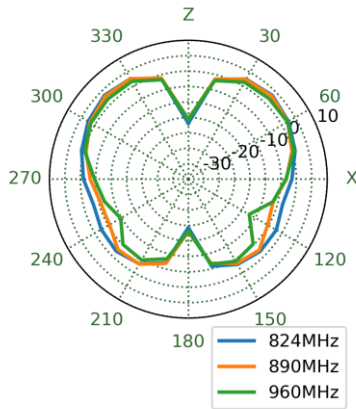

YZ Plane

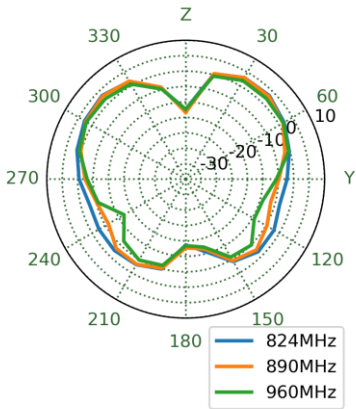

1470MHz

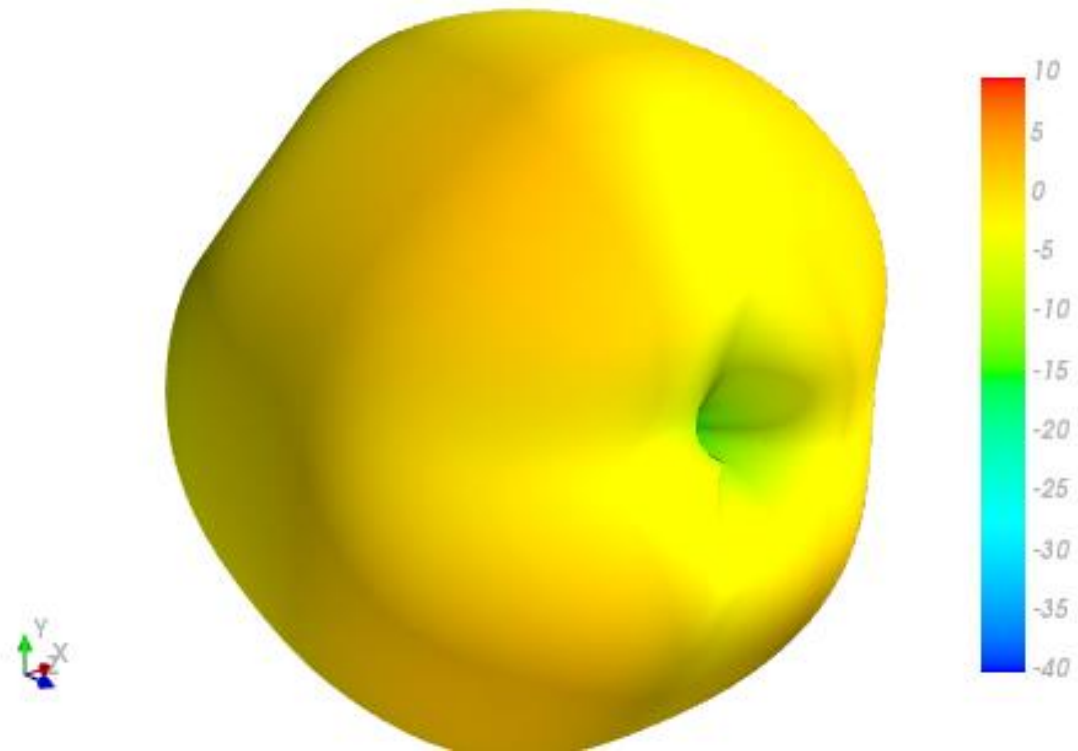

XY Plane

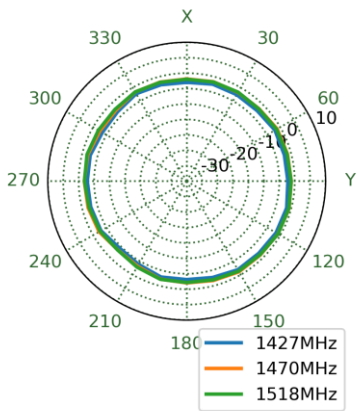

XZ Plane

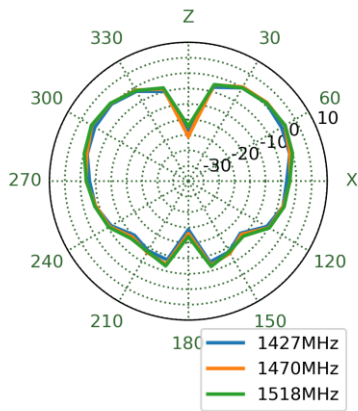

YZ Plane

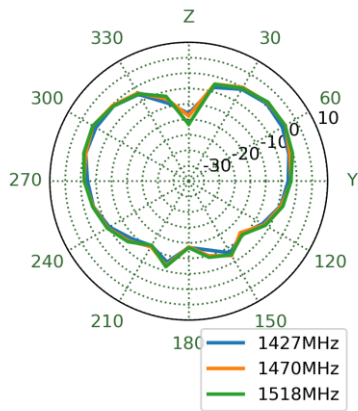

1805MHz

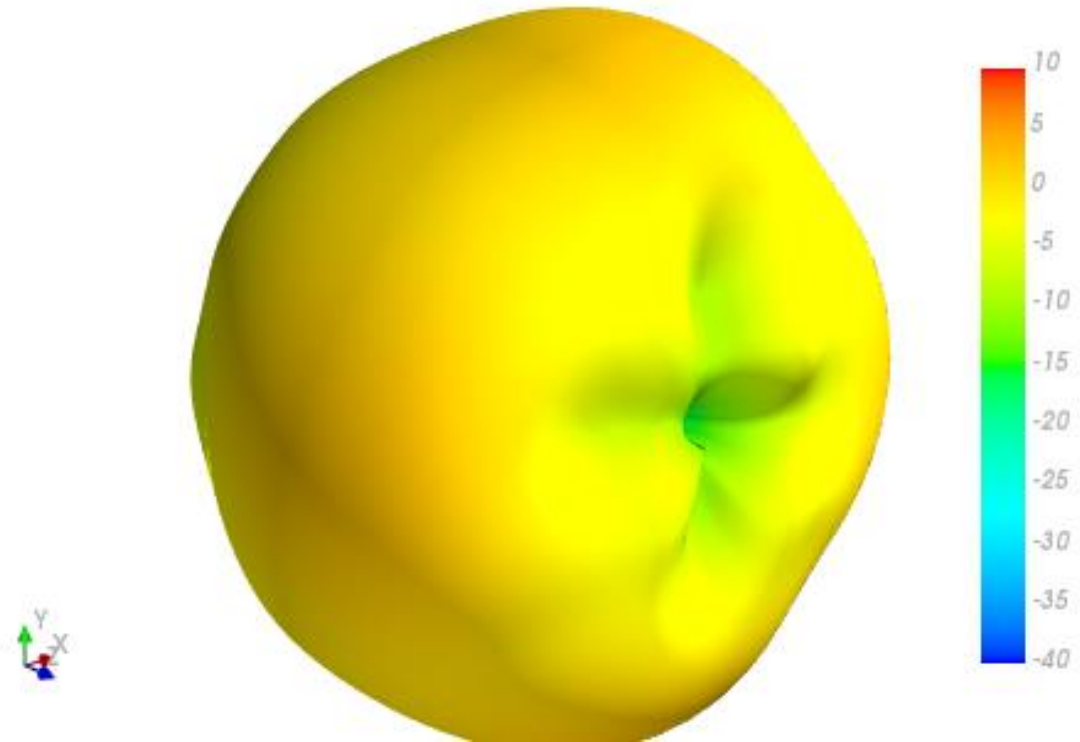

XY Plane

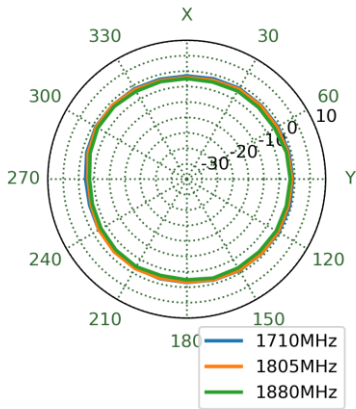

XZ Plane

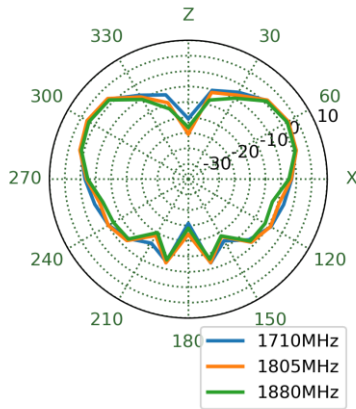

YZ Plane

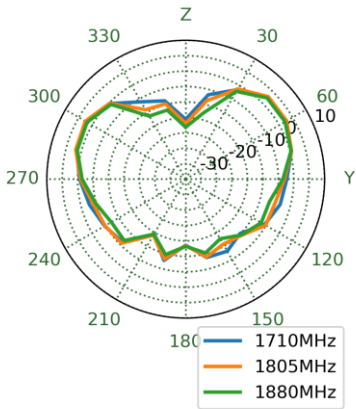

1990MHz

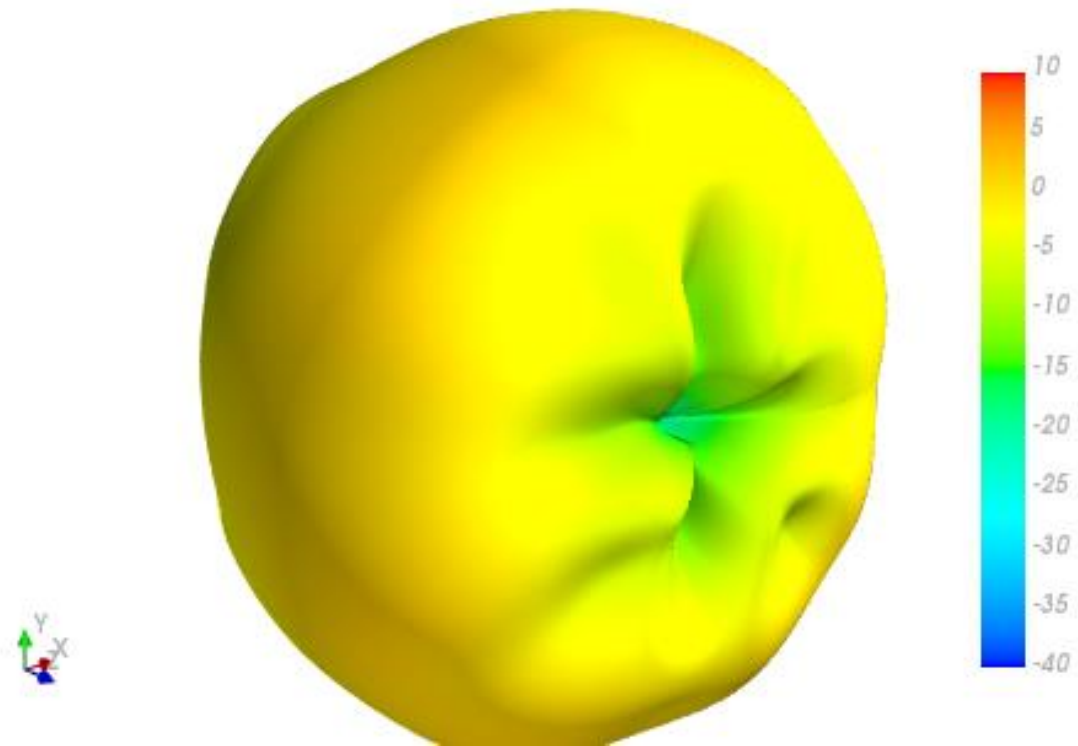

XY Plane

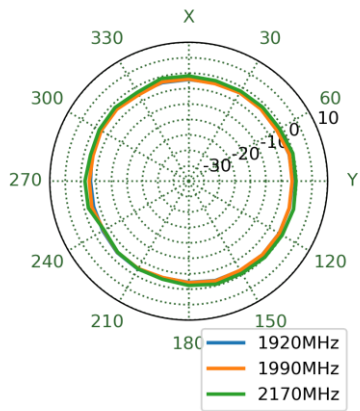

XZ Plane

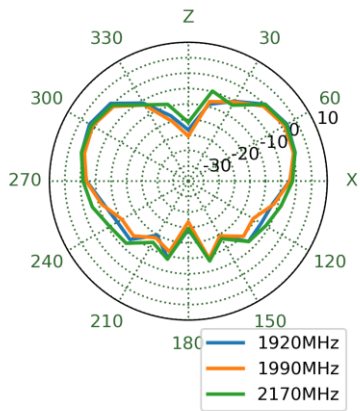

YZ Plane

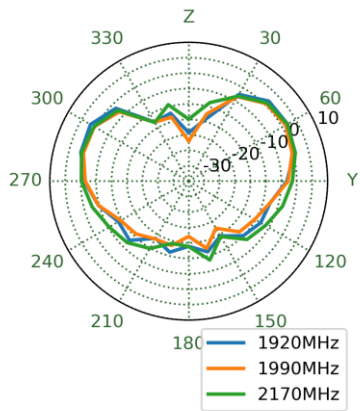

2595MHz

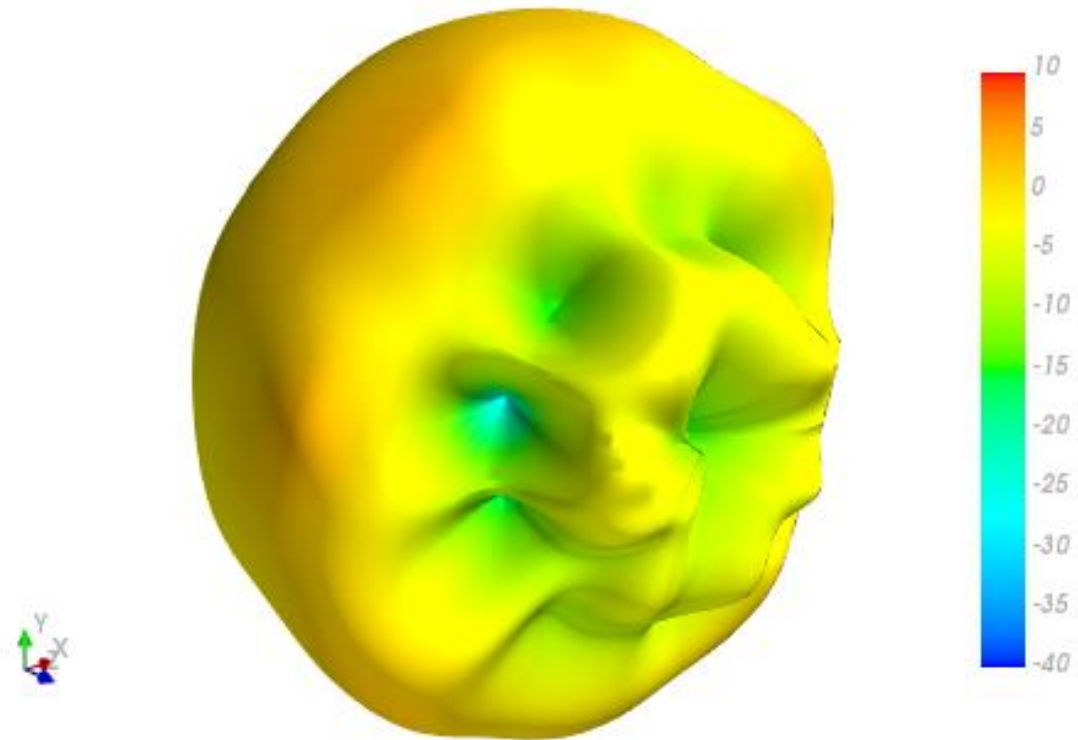

XY Plane

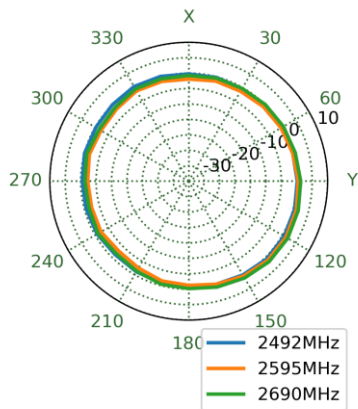

XZ Plane

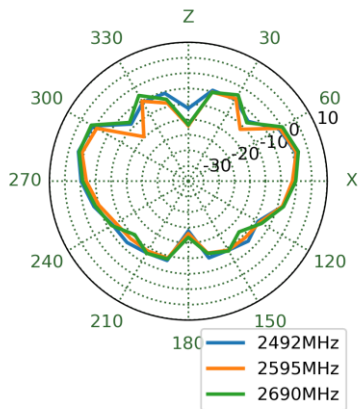

YZ Plane

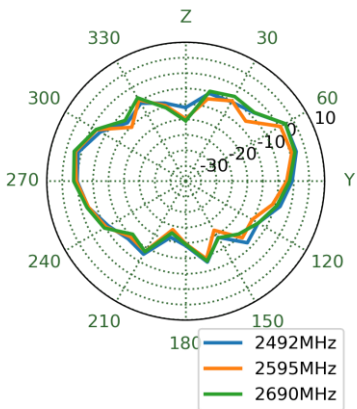

3550MHz

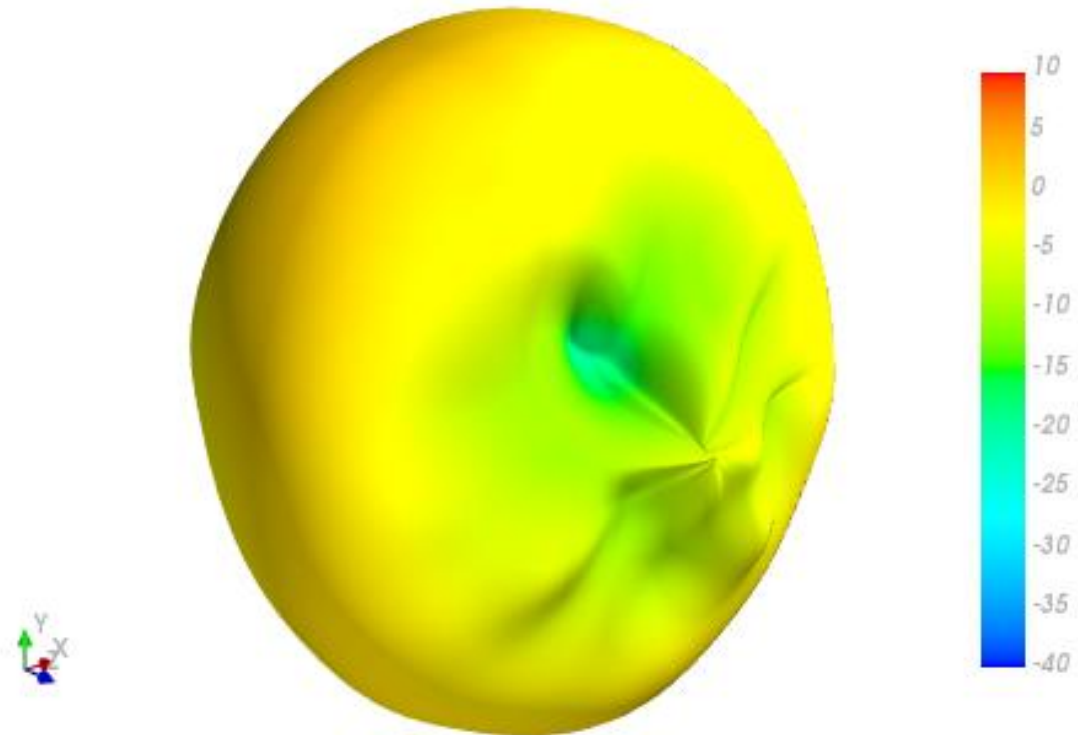

XY Plane

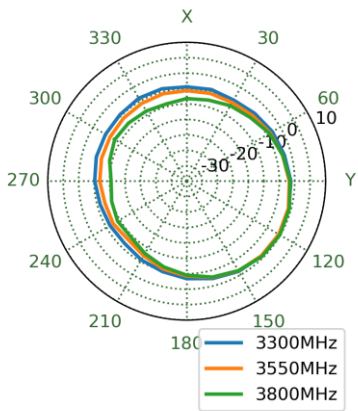

XZ Plane

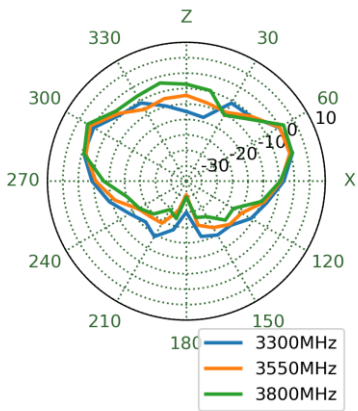

YZ Plane

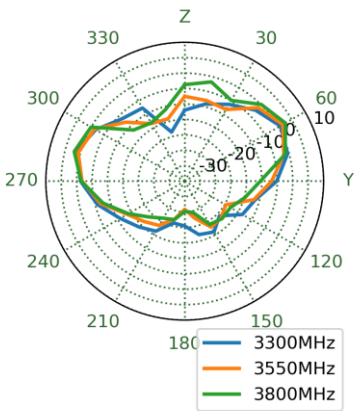



5530MHz

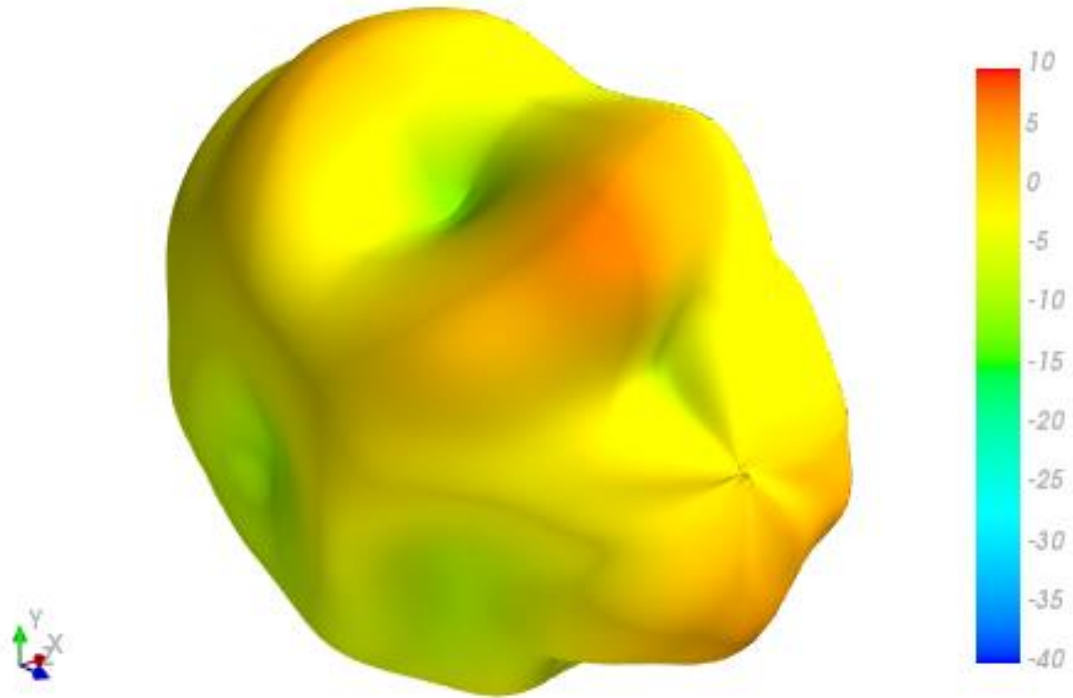

XY Plane

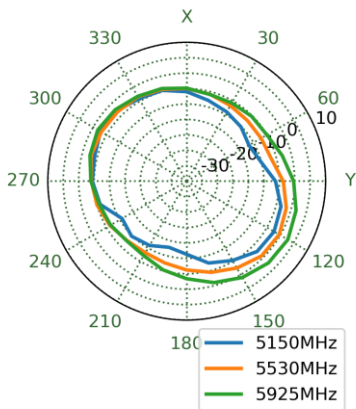

XZ Plane

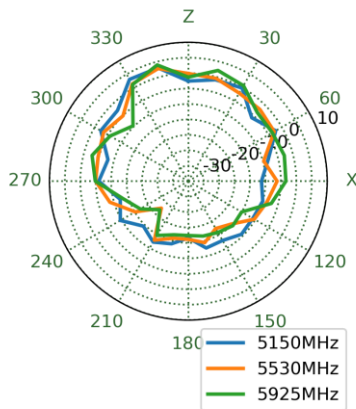

YZ Plane

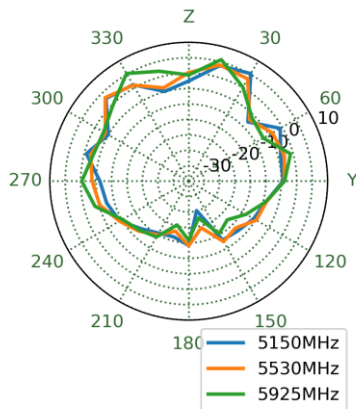

# 5. Mechanical Drawing (Units: mm)

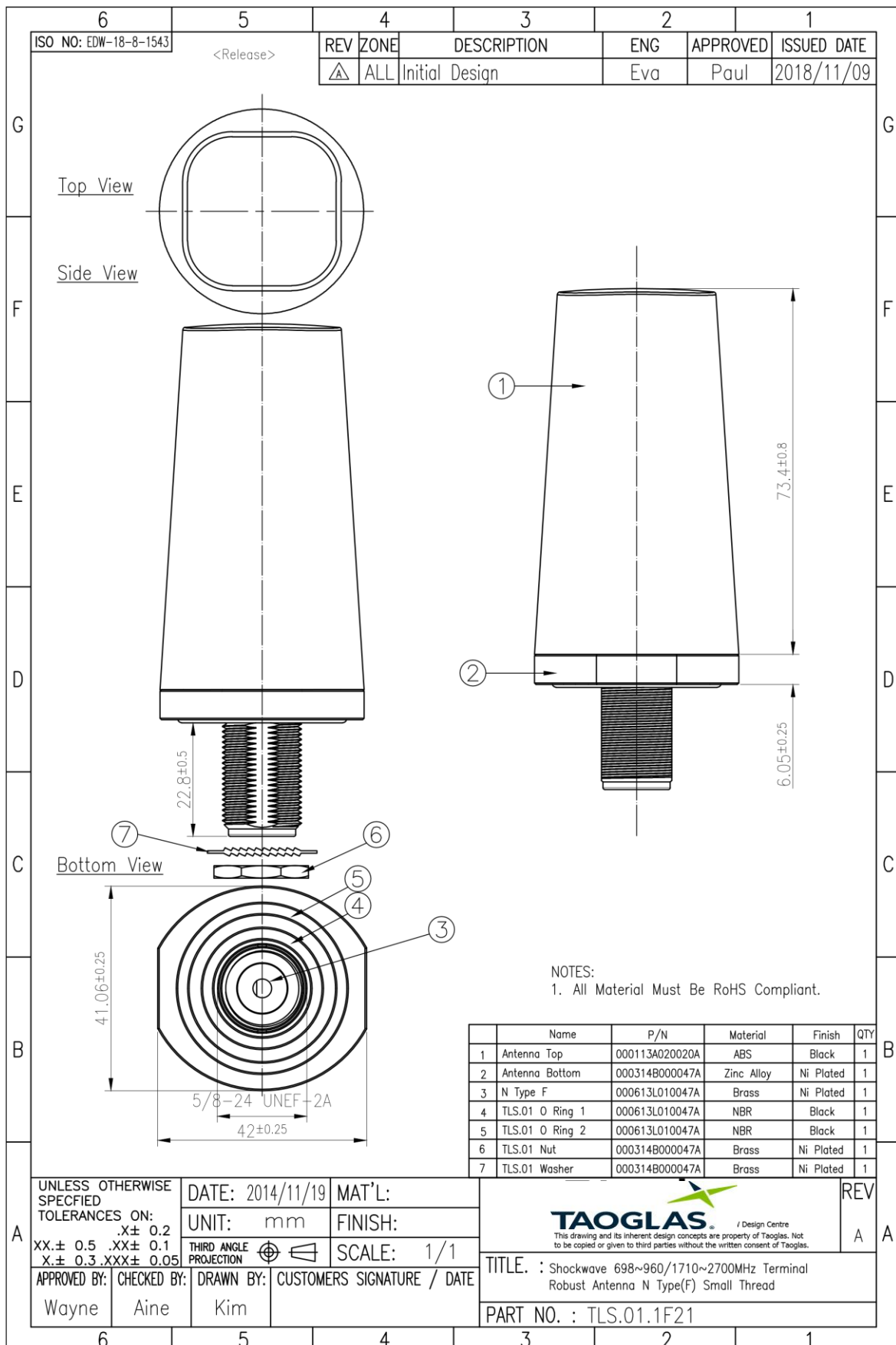

## 6. Installation

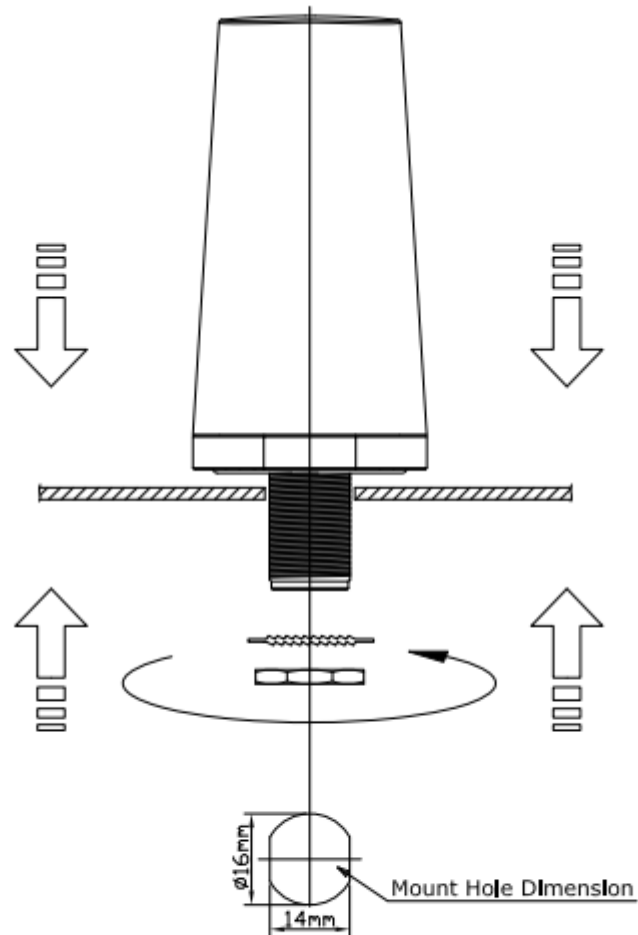

Recommended torque for mounting is 4.018 N.m or 41 kgf.cm

Maximum torque for mounting is 9.8 N.m or 100 kgf.cm

## 7. Packaging

### TLS.01.1F21

#### Packaging Specifications

1 No. TLS.01.1F21 per small box  
 Box Dimensions - 66 x 66 x 115mm  
 Weight - 210g

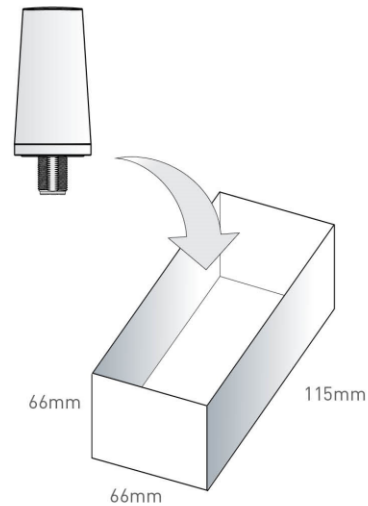

1 Outer Carton  
 Carton Dimensions - 430 x 380 x 280mm  
 60 pcs TLS.01.1F21 per carton  
 Weight - 13.02Kg

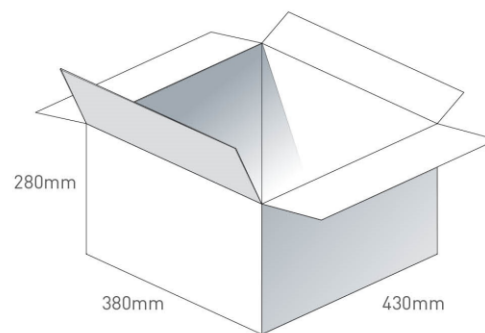

Pallet Dimensions 1100\*1100\*1550mm  
 30 Cartons per Pallet  
 10 Cartons per layer  
 3 Layers

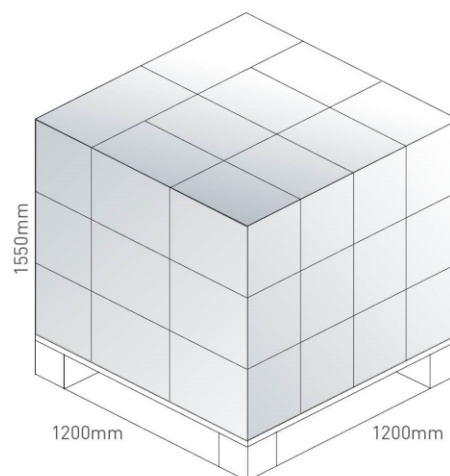

Changelog for the datasheet

**SPE-17-8-042 - TLS.01.1F21**

**Revision: D (Current Version)**

Date:	2022-09-02
Changes:	Updated specifications
Changes Made by:	Cesar Sousa

**Previous Revisions**

**Revision: C**

Date:	2019-11-18
Changes:	Included 5G data
Changes Made by:	Jack Conroy

**Revision: B**

Date:	2017-03-30
Changes:	Included LTE Table
Changes Made by:	Andy Mahoney

**Revision: A (Original First Release)**

Date:	2015-10-11
Notes:	Initial Release
Author:	Jack Conroy



**TAOGLAS**®

[www.taoglas.com](http://www.taoglas.com)

