

- Low Power Consumption
- Wide Common-Mode and Differential Voltage Ranges
- Low Input Bias and Offset Currents
- Output Short-Circuit Protection
- Low Total Harmonic Distortion . . . 0.003% Typ
- High Input Impedance . . . JFET Input Stage
- External Frequency Compensation
- Common-Mode Input Voltage Range Includes V_{CC+}
- Latch-Up-Free Operation
- High Slew Rate . . . 13 V/ μ s Typ

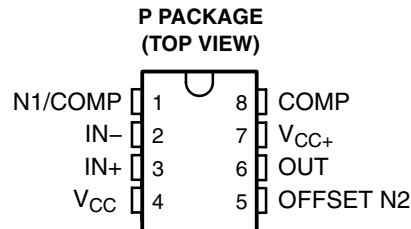

description

The TL080 JFET-input operational amplifier incorporates well-matched, high-voltage JFET and bipolar transistors in an integrated circuit. This device features high slew rates, low input bias and offset currents, and a low offset-voltage temperature coefficient. Offset adjustment and external-compensation options are available.

The TL080C is characterized for operation from 0°C to 70°C.

AVAILABLE OPTIONS

T _A	V _{IO} max AT 25°C	PACKAGE
		PLASTIC DIP (P)
0°C to 70°C	10 mV	TL080CP



Please be aware that an important notice concerning availability, standard warranty, and use in critical applications of Texas Instruments semiconductor products and disclaimers thereto appears at the end of this data sheet.

PRODUCTION DATA information is current as of publication date. Products conform to specifications per the terms of Texas Instruments standard warranty. Production processing does not necessarily include testing of all parameters.

**TEXAS
INSTRUMENTS**

POST OFFICE BOX 655303 • DALLAS, TEXAS 75265
POST OFFICE BOX 1443 • HOUSTON, TEXAS 77251-1443

Copyright © 2001, Texas Instruments Incorporated

TL080 JFET-INPUT OPERATIONAL AMPLIFIER

SLOS368 – JUNE 2001

schematic

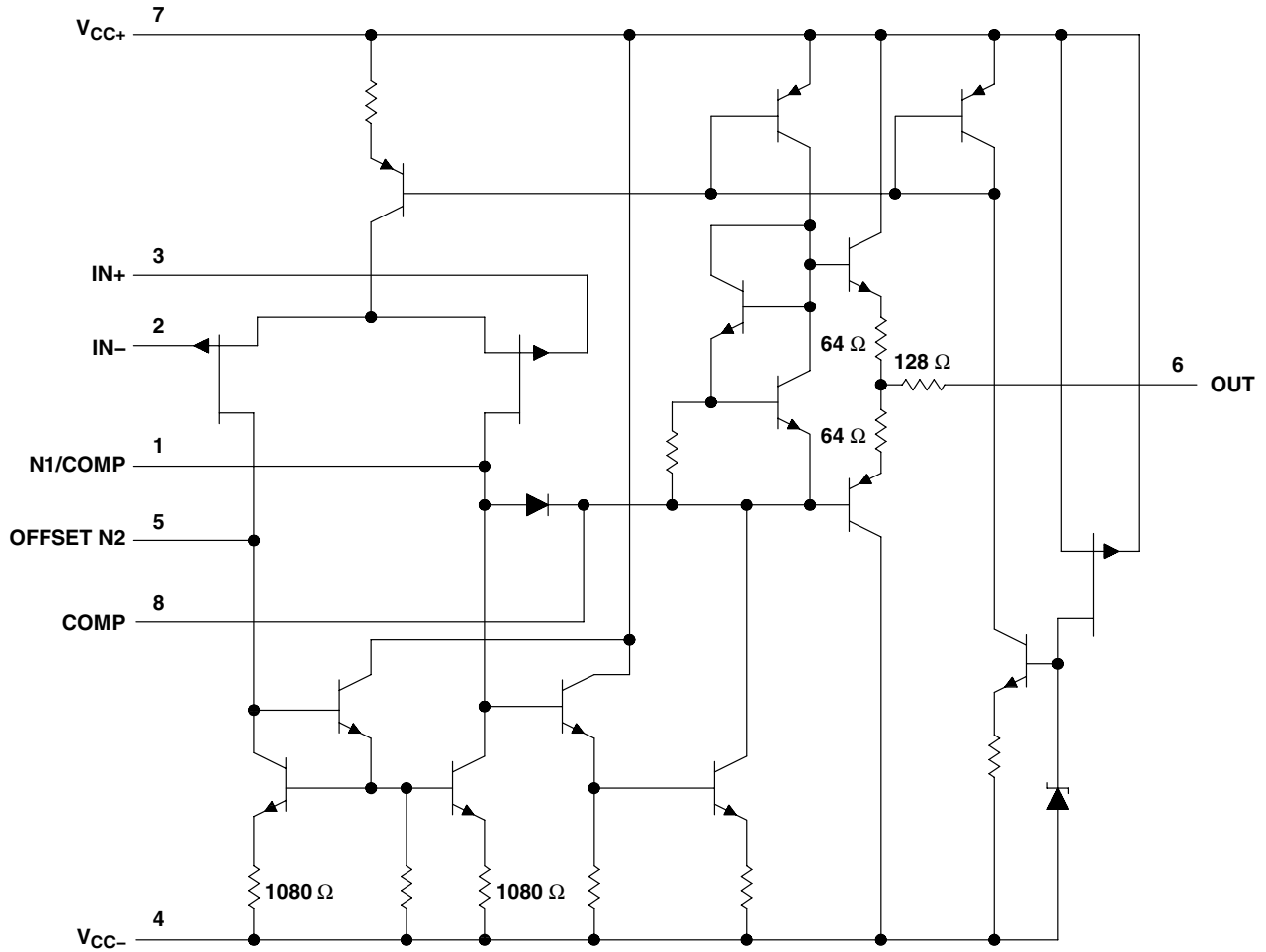

All component values shown are nominal.



POST OFFICE BOX 655303 • DALLAS, TEXAS 75265
POST OFFICE BOX 1443 • HOUSTON, TEXAS 77251-1443

absolute maximum ratings over operating free-air temperature range (unless otherwise noted)†

Supply voltage (see Note 1): V_{CC+}	18 V
V_{CC-}	–18 V
Differential input voltage, V_{ID} (see Note 2)	±30 V
Input voltage, V_I (see Notes 1 and 3)	±15 V
Duration of short-circuit current (see Note 4)	Unlimited
Package thermal impedance, θ_{JA} (see Notes 5 and 6)	85°C/W
Lead temperature 1,6 mm (1/16 inch) from case for 10 seconds	260°C
Storage temperature range, T_{stg}	–65°C to 150°C

† Stresses beyond those listed under “absolute maximum ratings” may cause permanent damage to the device. These are stress ratings only, and functional operation of the device at these or any other conditions beyond those indicated under “recommended operating conditions” is not implied. Exposure to absolute-maximum-rated conditions for extended periods may affect device reliability.

- NOTES:
1. All voltage values, except differential voltages, are with respect to the midpoint between V_{CC+} and V_{CC-} .
 2. Differential voltages are at $IN+$ with respect to $IN-$.
 3. The magnitude of the input voltage must never exceed the magnitude of the supply voltage or 15 V, whichever is less.
 4. The output can be shorted to ground or to either supply. Temperature and/or supply voltages must be limited to ensure that the dissipation rating is not exceeded.
 5. Maximum power dissipation is a function of $T_J(max)$, θ_{JA} , and T_A . The maximum allowable power dissipation at any allowable ambient temperature is $P_D = (T_J(max) - T_A)/\theta_{JA}$. Operating at the absolute maximum T_J of 150°C can impact reliability.
 6. The package thermal impedance is calculated in accordance with JESD 51-7.

electrical characteristics, $V_{CC\pm} = \pm 15$ V (unless otherwise noted)

PARAMETER		TEST CONDITIONS	T_A †	MIN	TYP	MAX	UNIT
V_{IO}	Input offset voltage	$V_O = 0, R_S = 50 \Omega$	25°C		3	15	mV
			Full range			20	
$\alpha_{V_{IO}}$	Temperature coefficient of input offset voltage	$V_O = 0, R_S = 50 \Omega$	Full range		18		$\mu V/^\circ C$
I_{IO}	Input offset current‡	$V_O = 0$	25°C		5	200	pA
			Full range			2	nA
I_{IB}	Input bias current‡	$V_O = 0$	25°C		30	400	pA
			Full range			10	nA
V_{ICR}	Common-mode input voltage range		25°C	±11	–12 to 15		V
V_{OM}	Maximum peak output voltage swing	$R_L = 10 k\Omega$	25°C	±12	±13.5		V
		$R_L \geq 10 k\Omega$	Full range	±12			
		$R_L \geq 2 k\Omega$		±10		±12	
A_{VD}	Large-signal differential voltage amplification	$V_O = \pm 10$ V, $R_L \geq 2 k\Omega$	25°C		25	200	V/mV
			Full range		15		
B_1	Unity-gain bandwidth		25°C		3		MHz
r_i	Input resistance		25°C		10^{12}		Ω
CMRR	Common-mode rejection ratio	$V_{IC} = V_{ICRmin}, V_O = 0, R_S = 50 \Omega$	25°C		70	86	dB
k_{SVR}	Supply-voltage rejection ratio ($\Delta V_{CC\pm}/\Delta V_{IO}$)	$V_{CC} = \pm 15$ V to ± 9 V, $V_O = 0, R_S = 50 \Omega$	25°C		70	86	dB
I_{CC}	Supply current	$V_O = 0,$ No load	25°C		1.4	2.8	mA
V_{O1}/V_{O2}	Crosstalk attenuation	$A_{VD} = 100$	25°C		120		dB

† All characteristics are measured under open-loop conditions with zero common-mode voltage unless otherwise specified. Full range for T_A is –40°C to 85°C.

‡ Input bias currents of a FET-input operational amplifier are normal junction reverse currents, which are temperature sensitive, as shown in Figure 5. Pulse techniques must be used that will maintain the junction temperature as close to the ambient temperature as possible.



TL080 JFET-INPUT OPERATIONAL AMPLIFIER

SLOS368 – JUNE 2001

operating characteristics, $V_{CC\pm} = \pm 15\text{ V}$, $T_A = 25^\circ\text{C}$

PARAMETER	TEST CONDITIONS			MIN	TYP	MAX	UNIT
SR Slew rate at unity gain	$V_I = 10\text{ V}$,	$R_L = 2\text{ k}\Omega$,	$C_L = 100\text{ pF}$, See Figure 1	8	13		$\text{V}/\mu\text{s}$
t_r Rise-time overshoot factor	$V_I = 20\text{ mV}$,	$R_L = 2\text{ k}\Omega$,	$C_L = 100\text{ pF}$, See Figure 1		0.05 20%		μs
V_n Equivalent input noise voltage	$R_S = 100\ \Omega$	$f = 1\text{ kHz}$			18		$\text{nV}/\sqrt{\text{Hz}}$
		$f = 10\text{ Hz to } 10\text{ kHz}$			4		μV
I_n Equivalent input noise current	$R_S = 100\ \Omega$,	$f = 1\text{ kHz}$			0.01		$\text{pA}/\sqrt{\text{Hz}}$
THD Total harmonic distortion	$V_{O(\text{rms})} = 10\text{ V}$,	$R_S \leq 1\text{ k}\Omega$,	$R_L \geq 2\text{ k}\Omega$, $f = 1\text{ kHz}$		0.003%		

APPLICATION INFORMATION

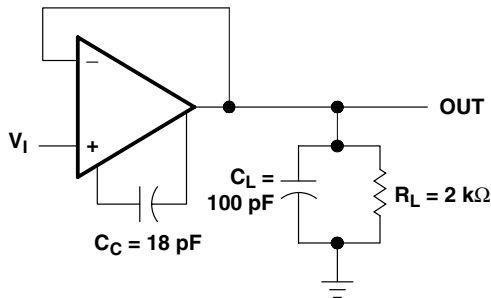

Figure 1. Unity-Gain Amplifier

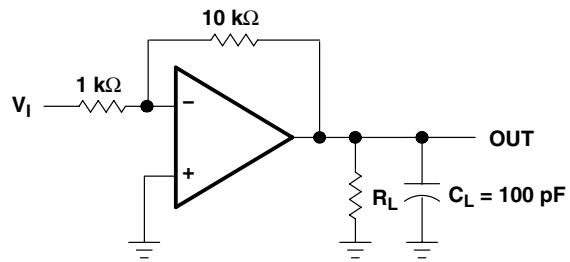

Figure 2. Gain-of-10 Inverting Amplifier

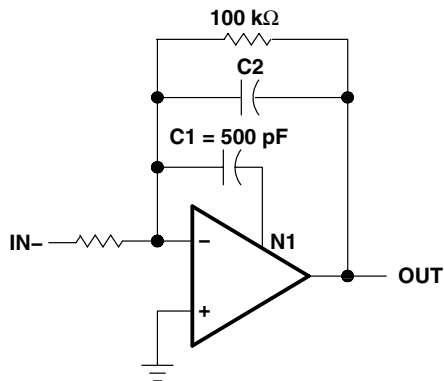

Figure 3. Feed-Forward Compensation

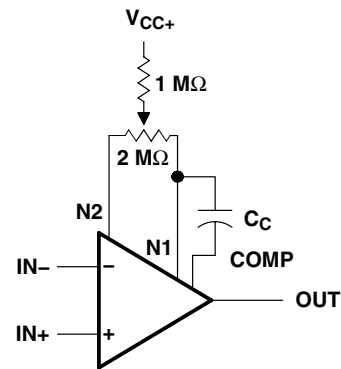

Figure 4. Input Offset Voltage Null Circuit

TYPICAL CHARACTERISTICS

Table of Graphs

		FIGURE	
V_{OM}	Maximum peak output voltage	vs Frequency	5, 6, 7
		vs Free-air temperature	8
		vs Load resistance	9
		vs Supply voltage	10
A_{VD}	Large-signal differential voltage amplification	vs Free-air temperature	11
		vs Frequency	12
	Differential voltage amplification	vs Frequency	13
P_D	Total power dissipation	vs Free-air temperature	14
I_{CC}	Supply current	vs Free-air temperature	14
		vs Supply voltage	15
I_{IB}	Input bias current	vs Free-air temperature	16
	Large-signal pulse response	vs Time	17
V_O	Output voltage	vs Elapsed time	18
CMRR	Common-mode rejection ratio	vs Free-air temperature	19
V_n	Equivalent input noise voltage	vs Frequency	20
THD	Total harmonic distortion	vs Frequency	21

MAXIMUM PEAK OUTPUT VOLTAGE
vs
FREQUENCY

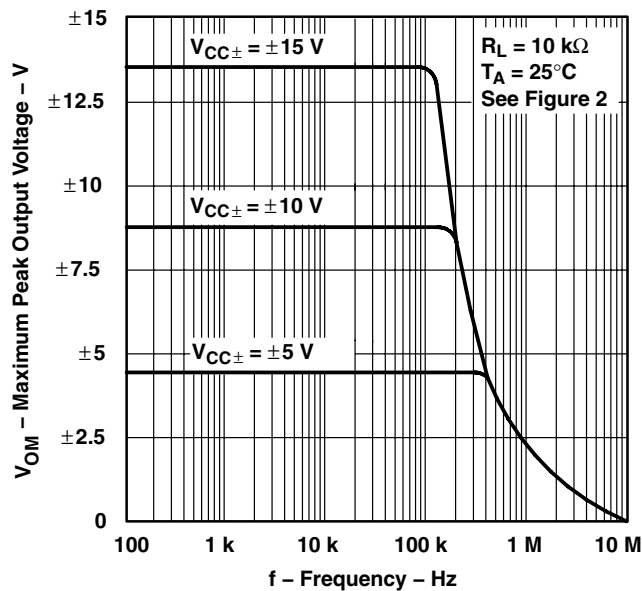

Figure 5

MAXIMUM PEAK OUTPUT VOLTAGE
vs
FREQUENCY

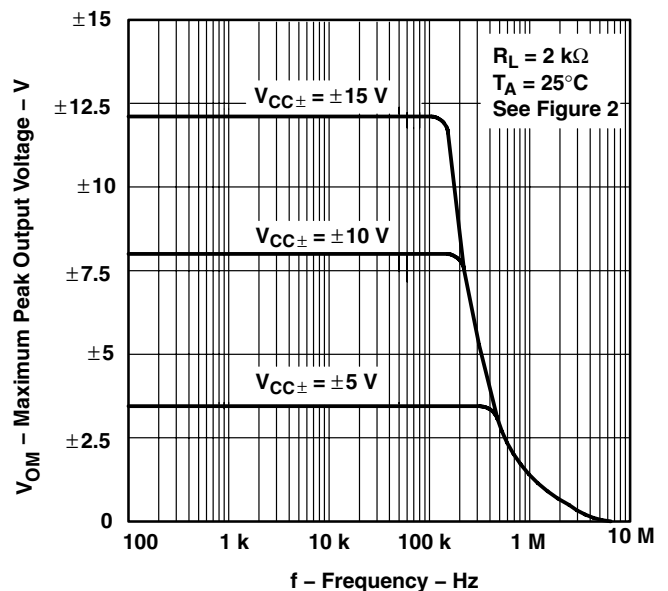

Figure 6

TL080 JFET-INPUT OPERATIONAL AMPLIFIER

SLOS368 – JUNE 2001

TYPICAL CHARACTERISTICS

MAXIMUM PEAK OUTPUT VOLTAGE
vs
FREQUENCY

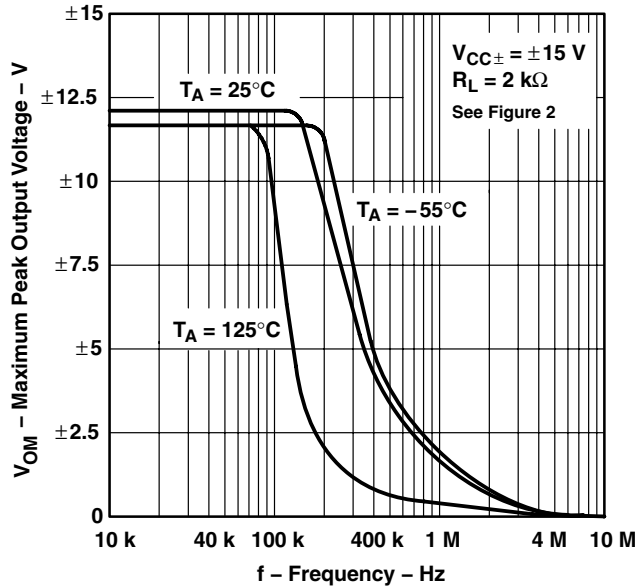

Figure 7

MAXIMUM PEAK OUTPUT VOLTAGE
vs
FREE-AIR TEMPERATURE

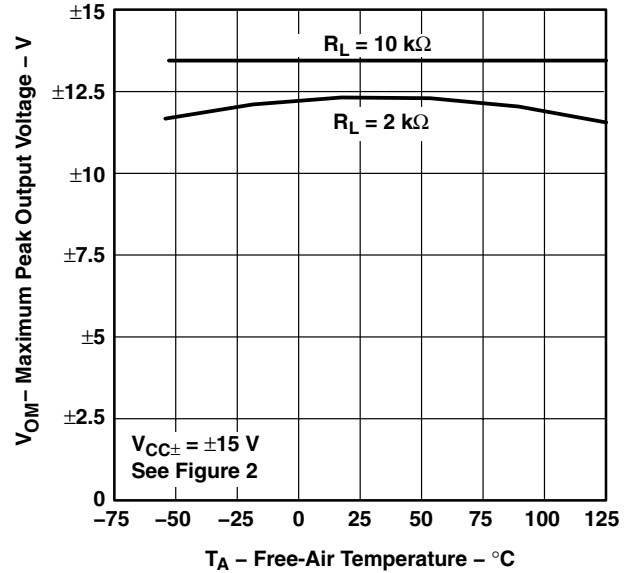

Figure 8

MAXIMUM PEAK OUTPUT VOLTAGE
vs
LOAD RESISTANCE

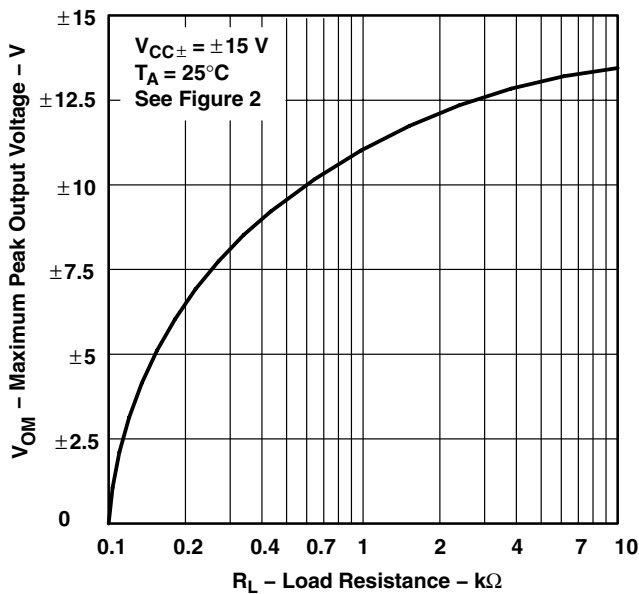

Figure 9

MAXIMUM PEAK OUTPUT VOLTAGE
vs
SUPPLY VOLTAGE

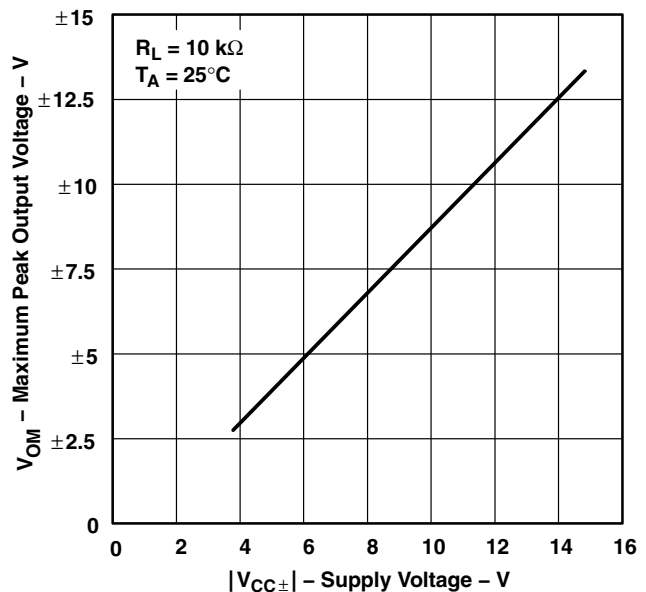

Figure 10



TYPICAL CHARACTERISTICS

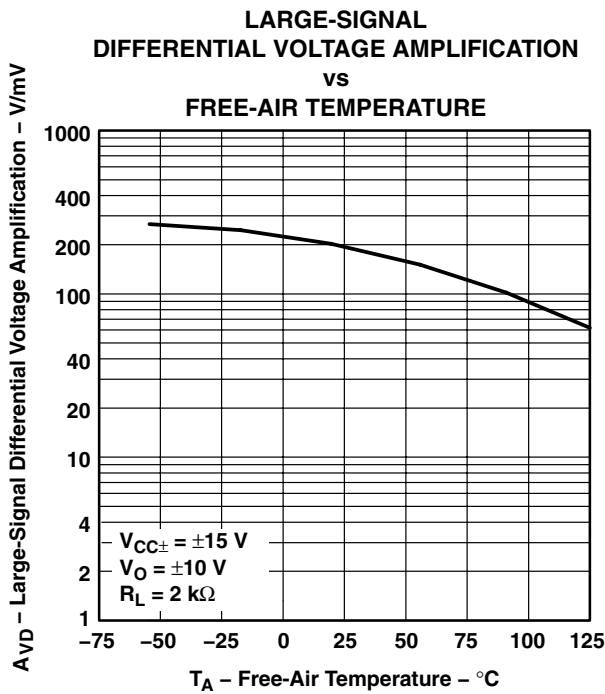

Figure 11

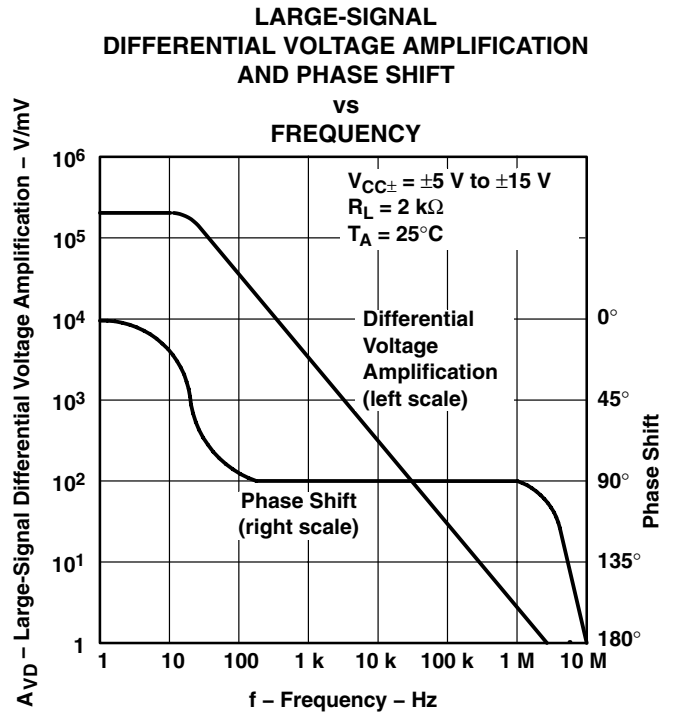

Figure 12

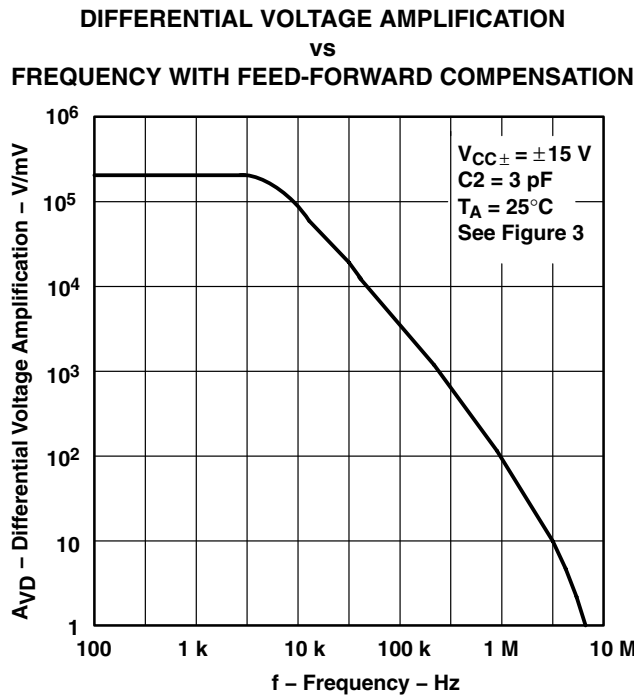

Figure 13

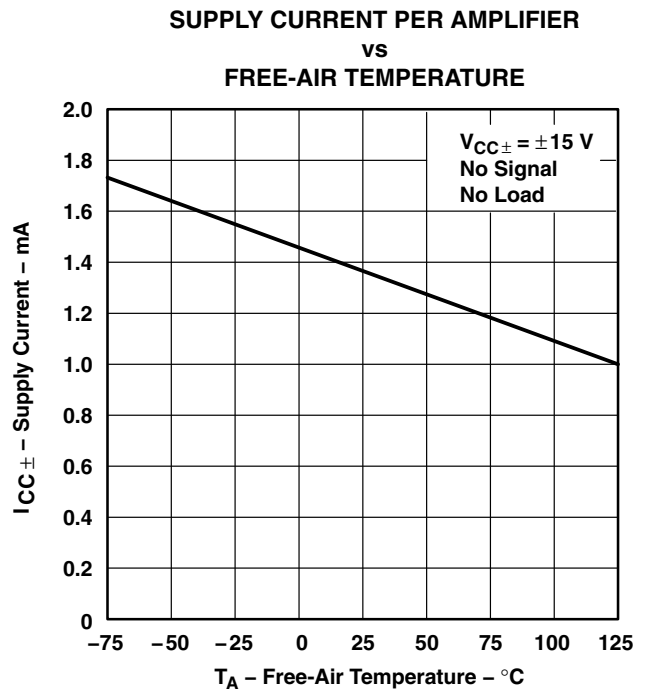
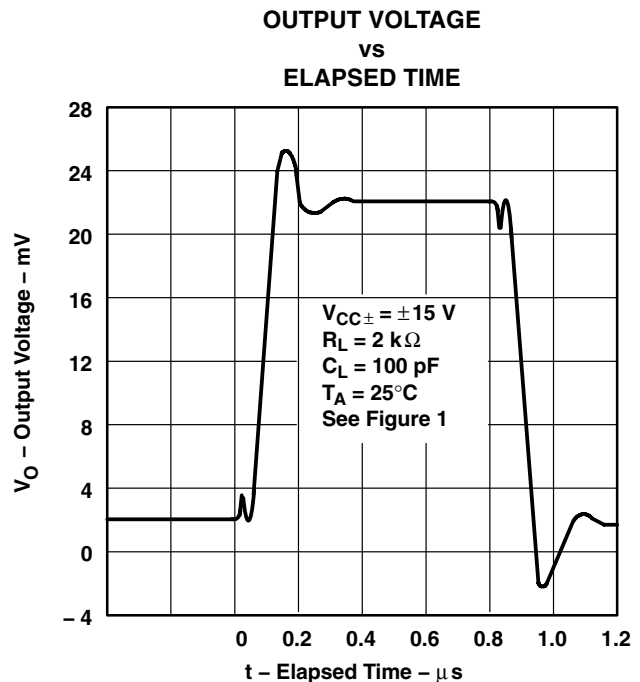
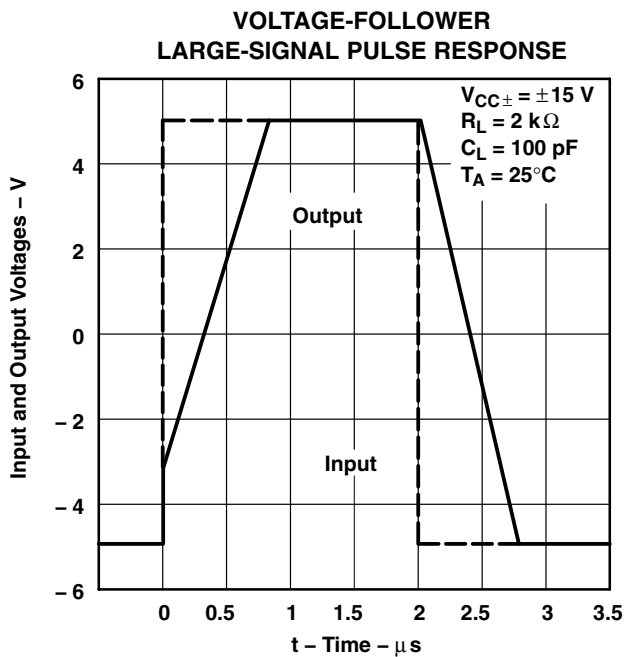
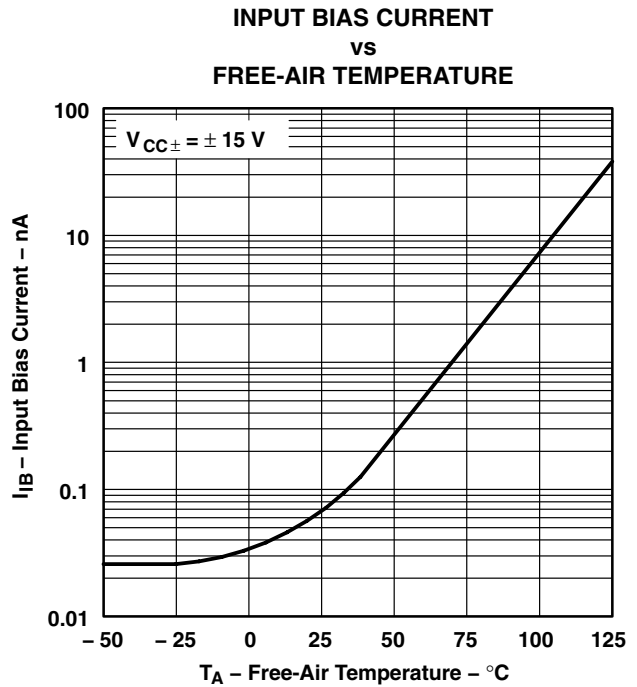
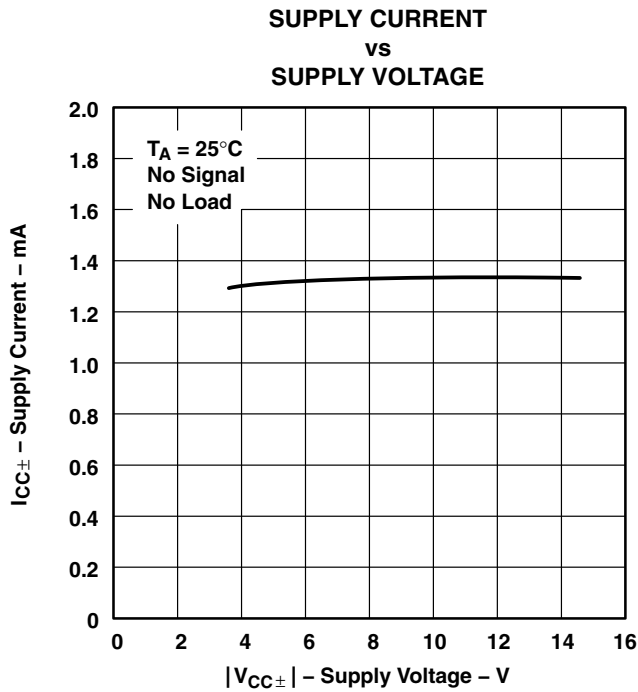

Figure 14

TYPICAL CHARACTERISTICS



TYPICAL CHARACTERISTICS

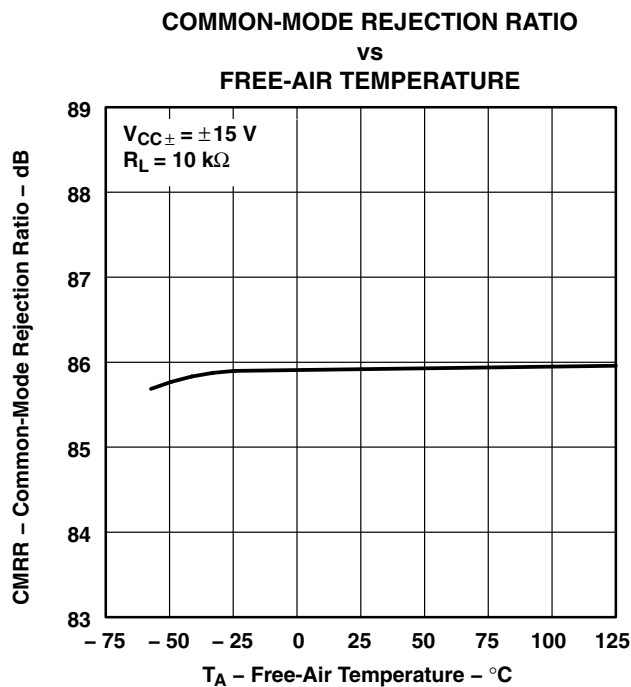

Figure 19

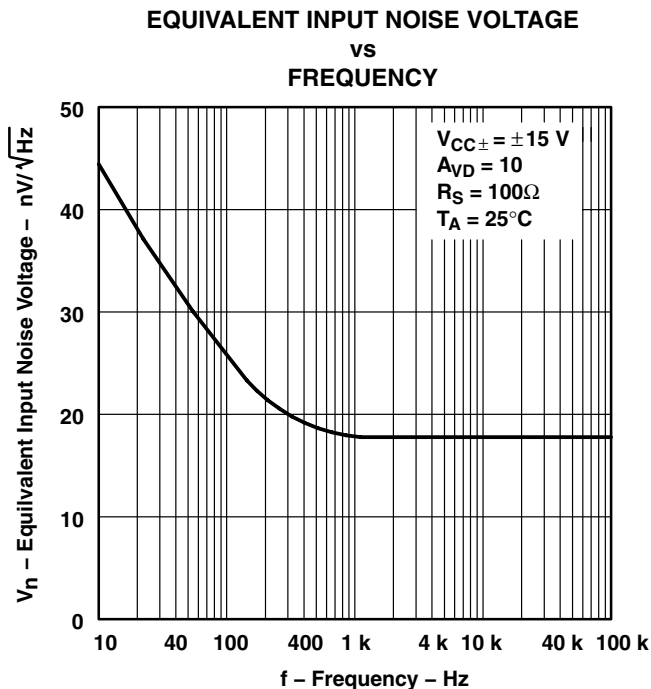

Figure 20

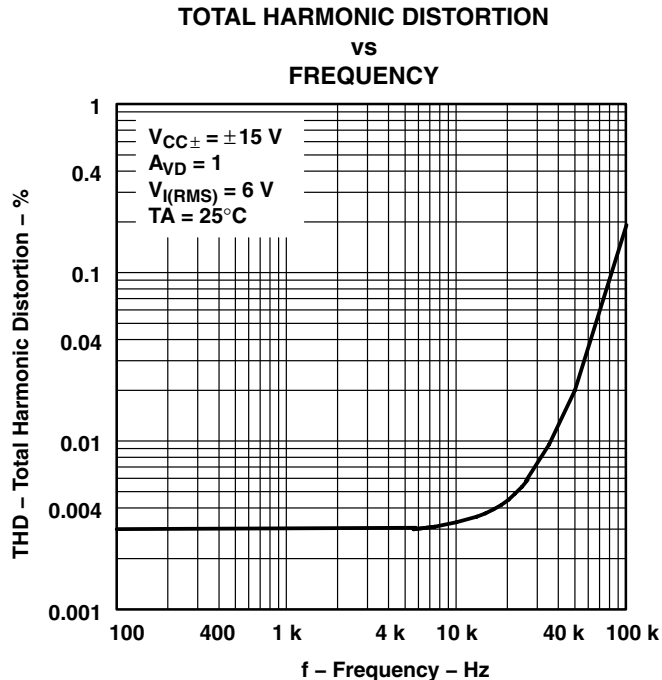

Figure 21

TL080 JFET-INPUT OPERATIONAL AMPLIFIER

SLOS368 – JUNE 2001

APPLICATION INFORMATION

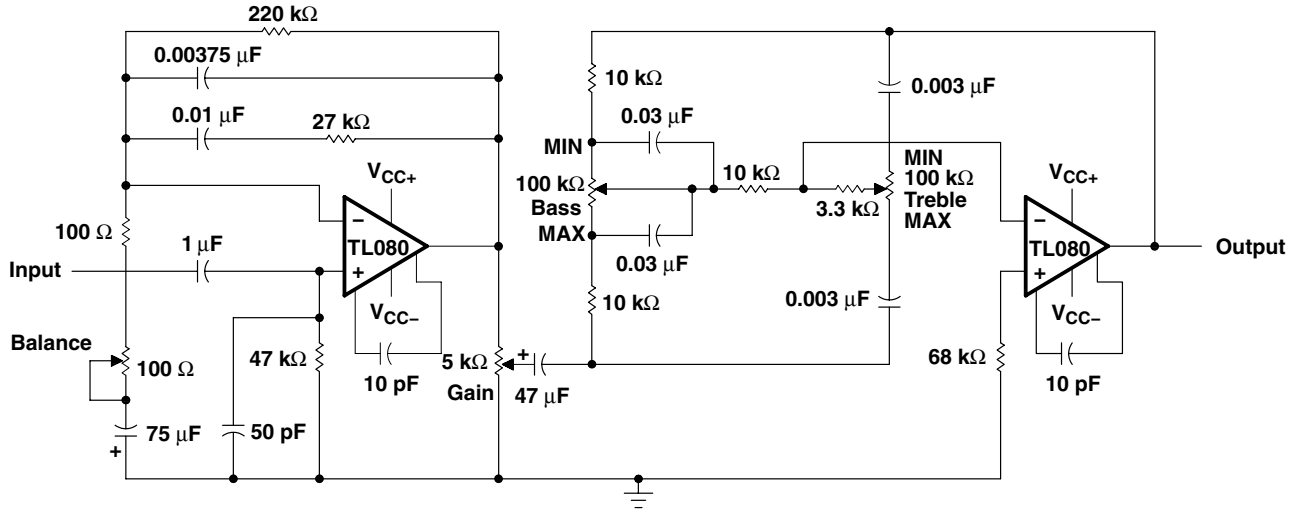

Figure 22. IC Preamplifier

PACKAGING INFORMATION

Orderable Device	Status (1)	Package Type	Package Drawing	Pins	Package Qty	Eco Plan (2)	Lead/Ball Finish (6)	MSL Peak Temp (3)	Op Temp (°C)	Device Marking (4/5)	Samples
TL080CP	OBSOLETE	PDIP	P	8		TBD	Call TI	Call TI	0 to 70	TL080CP	
TL080CPE4	OBSOLETE	PDIP	P	8		TBD	Call TI	Call TI	0 to 70		
TL080IP	OBSOLETE	PDIP	P	8		TBD	Call TI	Call TI	-40 to 85		

(1) The marketing status values are defined as follows:

ACTIVE: Product device recommended for new designs.

LIFEBUY: TI has announced that the device will be discontinued, and a lifetime-buy period is in effect.

NRND: Not recommended for new designs. Device is in production to support existing customers, but TI does not recommend using this part in a new design.

PREVIEW: Device has been announced but is not in production. Samples may or may not be available.

OBSOLETE: TI has discontinued the production of the device.

(2) Eco Plan - The planned eco-friendly classification: Pb-Free (RoHS), Pb-Free (RoHS Exempt), or Green (RoHS & no Sb/Br) - please check <http://www.ti.com/productcontent> for the latest availability information and additional product content details.

TBD: The Pb-Free/Green conversion plan has not been defined.

Pb-Free (RoHS): TI's terms "Lead-Free" or "Pb-Free" mean semiconductor products that are compatible with the current RoHS requirements for all 6 substances, including the requirement that lead not exceed 0.1% by weight in homogeneous materials. Where designed to be soldered at high temperatures, TI Pb-Free products are suitable for use in specified lead-free processes.

Pb-Free (RoHS Exempt): This component has a RoHS exemption for either 1) lead-based flip-chip solder bumps used between the die and package, or 2) lead-based die adhesive used between the die and leadframe. The component is otherwise considered Pb-Free (RoHS compatible) as defined above.

Green (RoHS & no Sb/Br): TI defines "Green" to mean Pb-Free (RoHS compatible), and free of Bromine (Br) and Antimony (Sb) based flame retardants (Br or Sb do not exceed 0.1% by weight in homogeneous material)

(3) MSL, Peak Temp. - The Moisture Sensitivity Level rating according to the JEDEC industry standard classifications, and peak solder temperature.

(4) There may be additional marking, which relates to the logo, the lot trace code information, or the environmental category on the device.

(5) Multiple Device Markings will be inside parentheses. Only one Device Marking contained in parentheses and separated by a "-" will appear on a device. If a line is indented then it is a continuation of the previous line and the two combined represent the entire Device Marking for that device.

(6) Lead/Ball Finish - Orderable Devices may have multiple material finish options. Finish options are separated by a vertical ruled line. Lead/Ball Finish values may wrap to two lines if the finish value exceeds the maximum column width.

Important Information and Disclaimer: The information provided on this page represents TI's knowledge and belief as of the date that it is provided. TI bases its knowledge and belief on information provided by third parties, and makes no representation or warranty as to the accuracy of such information. Efforts are underway to better integrate information from third parties. TI has taken and continues to take reasonable steps to provide representative and accurate information but may not have conducted destructive testing or chemical analysis on incoming materials and chemicals. TI and TI suppliers consider certain information to be proprietary, and thus CAS numbers and other limited information may not be available for release.

In no event shall TI's liability arising out of such information exceed the total purchase price of the TI part(s) at issue in this document sold by TI to Customer on an annual basis.

P (R-PDIP-T8)

PLASTIC DUAL-IN-LINE PACKAGE

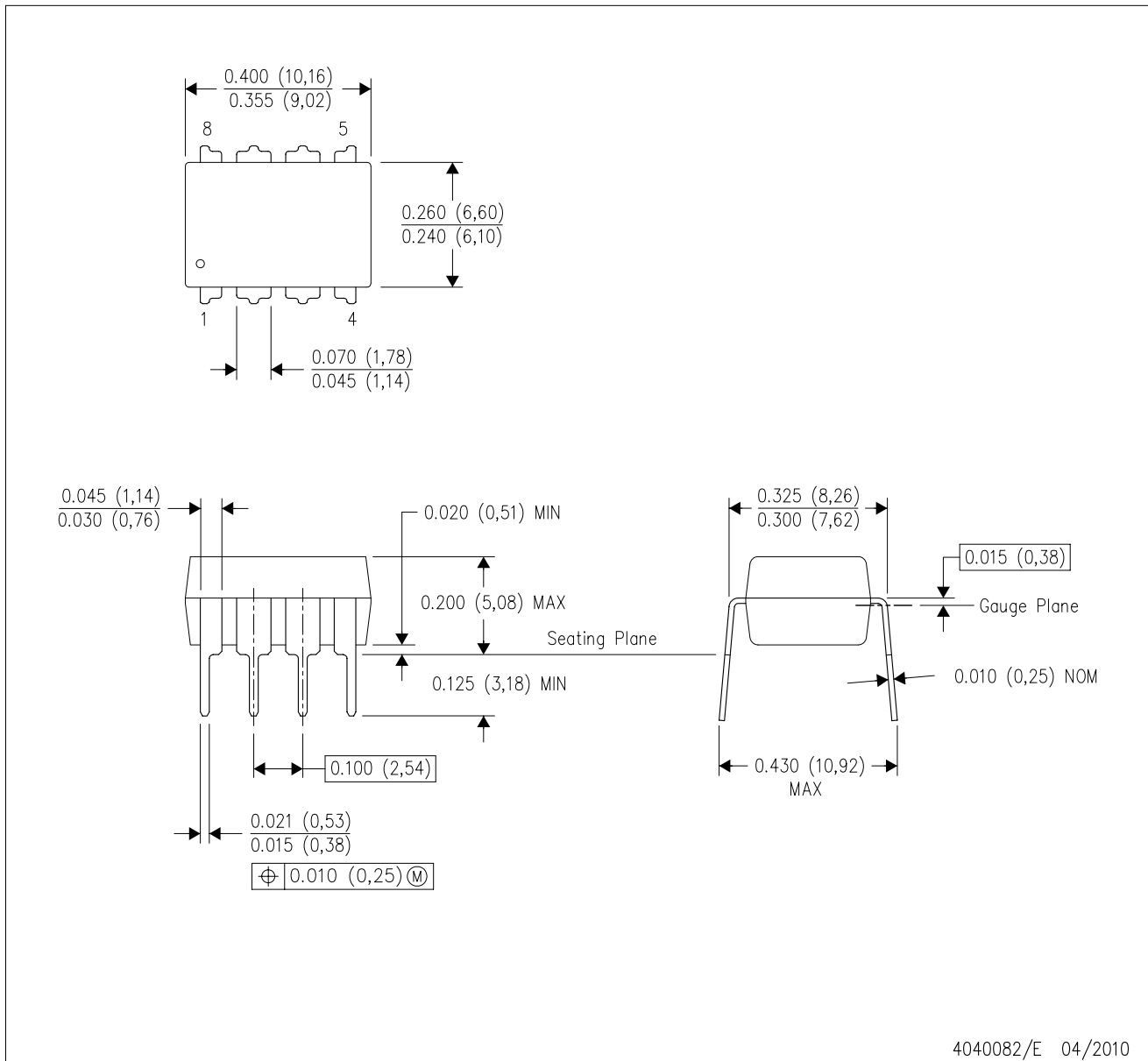

- NOTES:
- A. All linear dimensions are in inches (millimeters).
 - B. This drawing is subject to change without notice.
 - C. Falls within JEDEC MS-001 variation BA.

IMPORTANT NOTICE

Texas Instruments Incorporated and its subsidiaries (TI) reserve the right to make corrections, enhancements, improvements and other changes to its semiconductor products and services per JESD46, latest issue, and to discontinue any product or service per JESD48, latest issue. Buyers should obtain the latest relevant information before placing orders and should verify that such information is current and complete. All semiconductor products (also referred to herein as "components") are sold subject to TI's terms and conditions of sale supplied at the time of order acknowledgment.

TI warrants performance of its components to the specifications applicable at the time of sale, in accordance with the warranty in TI's terms and conditions of sale of semiconductor products. Testing and other quality control techniques are used to the extent TI deems necessary to support this warranty. Except where mandated by applicable law, testing of all parameters of each component is not necessarily performed.

TI assumes no liability for applications assistance or the design of Buyers' products. Buyers are responsible for their products and applications using TI components. To minimize the risks associated with Buyers' products and applications, Buyers should provide adequate design and operating safeguards.

TI does not warrant or represent that any license, either express or implied, is granted under any patent right, copyright, mask work right, or other intellectual property right relating to any combination, machine, or process in which TI components or services are used. Information published by TI regarding third-party products or services does not constitute a license to use such products or services or a warranty or endorsement thereof. Use of such information may require a license from a third party under the patents or other intellectual property of the third party, or a license from TI under the patents or other intellectual property of TI.

Reproduction of significant portions of TI information in TI data books or data sheets is permissible only if reproduction is without alteration and is accompanied by all associated warranties, conditions, limitations, and notices. TI is not responsible or liable for such altered documentation. Information of third parties may be subject to additional restrictions.

Resale of TI components or services with statements different from or beyond the parameters stated by TI for that component or service voids all express and any implied warranties for the associated TI component or service and is an unfair and deceptive business practice. TI is not responsible or liable for any such statements.

Buyer acknowledges and agrees that it is solely responsible for compliance with all legal, regulatory and safety-related requirements concerning its products, and any use of TI components in its applications, notwithstanding any applications-related information or support that may be provided by TI. Buyer represents and agrees that it has all the necessary expertise to create and implement safeguards which anticipate dangerous consequences of failures, monitor failures and their consequences, lessen the likelihood of failures that might cause harm and take appropriate remedial actions. Buyer will fully indemnify TI and its representatives against any damages arising out of the use of any TI components in safety-critical applications.

In some cases, TI components may be promoted specifically to facilitate safety-related applications. With such components, TI's goal is to help enable customers to design and create their own end-product solutions that meet applicable functional safety standards and requirements. Nonetheless, such components are subject to these terms.

No TI components are authorized for use in FDA Class III (or similar life-critical medical equipment) unless authorized officers of the parties have executed a special agreement specifically governing such use.

Only those TI components which TI has specifically designated as military grade or "enhanced plastic" are designed and intended for use in military/aerospace applications or environments. Buyer acknowledges and agrees that any military or aerospace use of TI components which have **not** been so designated is solely at the Buyer's risk, and that Buyer is solely responsible for compliance with all legal and regulatory requirements in connection with such use.

TI has specifically designated certain components as meeting ISO/TS16949 requirements, mainly for automotive use. In any case of use of non-designated products, TI will not be responsible for any failure to meet ISO/TS16949.

Products

Audio	www.ti.com/audio
Amplifiers	amplifier.ti.com
Data Converters	dataconverter.ti.com
DLP® Products	www.dlp.com
DSP	dsp.ti.com
Clocks and Timers	www.ti.com/clocks
Interface	interface.ti.com
Logic	logic.ti.com
Power Mgmt	power.ti.com
Microcontrollers	microcontroller.ti.com
RFID	www.ti-rfid.com
OMAP Applications Processors	www.ti.com/omap
Wireless Connectivity	www.ti.com/wirelessconnectivity

Applications

Automotive and Transportation	www.ti.com/automotive
Communications and Telecom	www.ti.com/communications
Computers and Peripherals	www.ti.com/computers
Consumer Electronics	www.ti.com/consumer-apps
Energy and Lighting	www.ti.com/energy
Industrial	www.ti.com/industrial
Medical	www.ti.com/medical
Security	www.ti.com/security
Space, Avionics and Defense	www.ti.com/space-avionics-defense
Video and Imaging	www.ti.com/video

TI E2E Community

e2e.ti.com