



TAOGLAS®



Datasheet

5G/4G 4*MIMO Cross-Polarized Antenna

Part No:
TGX.04.W.A.001

Description:

White Wideband 400-6000MHz 5G/4G 4*MIMO Cross Polarized Antenna
With Multi-mount Bracket (Wall, Pole and Suction Cup Mounting options)

Features:

- Highest efficiency for 450-6000MHz wideband applications
- Fully 5G/4G Cellular Operational
- Cross Polarized Dipole Antennas
- IP67 Rated Enclosure
- Omnidirectional Gain Patterns leading to better coverage
- Multi-function bracket including Wall, Pole, and Glass Mount options
- Cable: 3m TGC-200
- Connector: SMA Male Straight – Fully Customizable
- Dimensions: 165 * 165 * 149 mm (Including Bracket)
- RoHS & Reach Compliant

1. Introduction	3
2. Specifications	5
3. Antenna Characteristics	9
4. Radiation Patterns	12
5. Mechanical Drawing	49
6. Installation Guidelines	50
7. Packaging	54
8. Application Note	55
<hr/>	
Changelog	63

Taoglas makes no warranties based on the accuracy or completeness of the contents of this document and reserves the right to make changes to specifications and product descriptions at any time without notice. Taoglas reserves all rights to this document and the information contained herein. Reproduction, use or disclosure to third parties without express permission is strictly prohibited.



1. Introduction



The Taoglas TGX.04.W is a white 4* 5G/4G MIMO cross-polarized omnidirectional dipole antenna with a wide bandwidth covering all worldwide sub 6GHz cellular bands from 400 to 6000MHz. It uses four dipole antennas to deliver the best possible throughput and quality improvements in transmitting and receive signal levels, leading to better coverage and performance, especially in urban environments. It is designed for multiple mounting options to allow for a variety of use cases and is supplied with 3m of low loss cable with SMA(M) connectors as standard.

Typical Applications include:

- Agriculture and Rural 5G
- Coverage enhancement systems
- Commercial Transportation
- Connected Enterprise
- Public Safety and First Responder

The TGX.04 design is an evolution of our hugely successful TG.45 antenna design and it is unrivalled in its ability to cover all wideband 5G/4G Sub 6GHz bands. The antenna is tuned for great performance at the recently established 5G NR bands between 3300 - 4200MHz and covers Band 31 (450MHz) and Band 71 (617MHz) at the lower end of the 5G/4G frequency spectrum. High Efficiency and stable Gain is achievable at each band on all 4 MIMO antennas.

The cross polarized antennas' layout also enhances MIMO performance capabilities, thus improving signal quality. This is achieved by positioning the antenna elements orthogonal to each other aligning with the +/- 45-degree polarised signals received from most base station antennas and in turn, enhances throughput capacity giving the user the best possible cellular performance for their device. The TGX.04 has been designed for typical applications including gateways, routers and wireless access points that require, high efficiency and unrivalled performance.

The robust TGX.04 enclosure is IP67 rated and manufactured from ASA for exceptional mechanical performance. The bracket is designed to allow for multiple mounting options, including wall or pole or mounting and it is supplied with suction cups to facilitate glass mounting. All accessories for each mounting option are included with the product. The TGX.04 is an omnidirectional antenna, but the mounting bracket allows the user to position the antenna and lock it into place for optimal performance.

The TGC-200 cable and SMA(M) connector are fully customizable depending on your specific requirements. Contact your regional Taoglas customer support team for more information.

2. Specifications

Electrical									
Band	Frequency (MHz)		Efficiency (%)	Average Gain (dB)	Peak Gain (dBi)	Impedance	Max Input Power	Polarization	Radiation Pattern
4G/3G Band 31,87,88	430~470	MIMO 1	36.4	-4.39	1.0	50 Ω	10W	Cross Polarized Linear Antennas	Omni-Directional
		MIMO 2	39.5	-4.04	-0.4				
		MIMO 3	37.1	-4.31	-0.2				
		MIMO 4	29.5	-5.3	0.2				
5GNR/4G Band 71	617~698	MIMO 1	32.3	-4.91	0.7				
		MIMO 2	26.7	-5.73	1.1				
		MIMO 3	29	-5.38	-0.6				
		MIMO 4	33.9	-4.7	1.9				
4G/3G Band 12,13,14,17,28,29	698~806	MIMO 1	50	-3.01	2.7				
		MIMO 2	34.3	-4.65	1.9				
		MIMO 3	45.4	-3.43	0.9				
		MIMO 4	50.1	-3	2.3				
4G/3G/NB-IoT/Cat M Band 5,8,18,19,20,26,27	824~960	MIMO 1	57.2	-2.42	2.8				
		MIMO 2	50.1	-3	2.7				
		MIMO 3	53.5	-2.72	2.3				
		MIMO 4	37.1	-4.3	2.3				
5GNR/4G Band 21,32,74,75,76	1427~1518	MIMO 1	43	-3.67	2.2				
		MIMO 2	43.7	-3.6	3.1				
		MIMO 3	34.3	-4.65	1.3				
		MIMO 4	38.2	-4.18	2.4				
4G/3G Band 1,2,3,4,9,23,25,35,39,66	1710~2200	MIMO 1	49.7	-3.04	3.6				
		MIMO 2	42.1	-3.76	4.2				
		MIMO 3	42.7	-3.69	3.3				
		MIMO 4	48.3	-3.16	2.7				
4G/3G Band 7,30,38,40,41	2300~2690	MIMO 1	38	-4.2	3.7				
		MIMO 2	34	-4.68	4.3				
		MIMO 3	35	-4.56	3.8				
		MIMO 4	37.2	-4.3	3.0				
5GNR/4G Band 22,42,48,77,78,79	3300~5000	MIMO 1	39.7	-4.03	3.5				
		MIMO 2	39.2	-4.08	3.3				
		MIMO 3	38.8	-4.15	3.5				
		MIMO 4	40.6	-3.94	2.8				
LTE5200/ Wi-Fi 5800	5150~5925	MIMO 1	28.7	-5.42	1.6				
		MIMO 2	29	-5.38	2.2				
		MIMO 3	28.5	-5.45	2.3				
		MIMO 4	28.4	-5.47	1.5				

Cross Polar Discrimination (dB) – XPD			
Band	Frequency (MHz)		YZ Plane (Azimuth)
4G/3G Band 31	430~470	MIMO 1	22.58
		MIMO 2	19.76
		MIMO 3	17.03
		MIMO 4	14.80
5GNR/4G Band 71	617~698	MIMO 1	18.80
		MIMO 2	15.56
		MIMO 3	17.29
		MIMO 4	23.60
4G/3G Band 12,13,14,17,28,29	698~806	MIMO 1	25.85
		MIMO 2	23.17
		MIMO 3	16.32
		MIMO 4	24.70
4G/3G/NB-IoT/Cat M Band 5,8,18,19,20,26,27	824~960	MIMO 1	26.24
		MIMO 2	25.46
		MIMO 3	18.42
		MIMO 4	31.80
5GNR/4G Band 21,32,74,75,76	1427~1518	MIMO 1	17.43
		MIMO 2	23.08
		MIMO 3	16.29
		MIMO 4	18.60
4G/3G Band 1,2,3,4,9,23,25,35,39,66	1710~2200	MIMO 1	26.31
		MIMO 2	25.16
		MIMO 3	20.84
		MIMO 4	20.40
4G/3G Band 7,30,38,40,41	2300~2690	MIMO 1	25.88
		MIMO 2	29.85
		MIMO 3	17.93
		MIMO 4	18.80
5GNR/4G Band 22,42,48,77,78,79	3300~5000	MIMO 1	26.0
		MIMO 2	26.5
		MIMO 3	20.2
		MIMO 4	19.0
LTE5200/ Wi-Fi 5800	5150~5925	MIMO 1	24.57
		MIMO 2	18.44
		MIMO 3	24.07
		MIMO 4	18.50

*XPD is the average of the maximum Cross Polar Discrimination at each frequency band

Mechanical

Dimensions	165*165* 149mm
Weight	900g
Plastic Material	ASA
Waterproof Rating	IP67
Cable	3m TGC-200
Connector	SMA (M) Straight

Environmental

Temperature Range	-40°C to 85°C
-------------------	---------------

5G/4G Bands			
Band Number	5GNR / FR1 / LTE / LTE-Advanced / WCDMA / HSPA / HSPA+ / TD-SCDMA		
	Uplink	Downlink	Covered
1	UL: 1920 to 1980	DL: 2110 to 2170	✓
2	UL: 1850 to 1910	DL: 1930 to 1990	✓
3	UL: 1710 to 1785	DL: 1805 to 1880	✓
4	UL: 1710 to 1755	DL: 2110 to 2155	✓
5	UL: 824 to 849	DL: 869 to 894	✓
7	UL: 2500 to 2570	DL: 2620 to 2690	✓
8	UL: 880 to 915	DL: 925 to 960	✓
9	UL: 1749.9 to 1784.9	DL: 1844.9 to 1879.9	✓
11	UL: 1427.9 to 1447.9	DL: 1475.9 to 1495.9	✓
12	UL: 699 to 716	DL: 729 to 746	✓
13	UL: 777 to 787	DL: 746 to 756	✓
14	UL: 788 to 798	DL: 758 to 768	✓
17	UL: 704 to 716	DL: 734 to 746	✓
18	UL: 815 to 830	DL: 860 to 875	✓
19	UL: 830 to 845	DL: 875 to 890	✓
20	UL: 832 to 862	DL: 791 to 821	✓
21	UL: 1447.9 to 1462.9	DL: 1495.9 to 1510.9	✓
22	UL: 3410 to 3490	DL: 3510 to 3590	✓
23	UL: 2000 to 2020	DL: 2180 to 2200	✓
24	UL: 1625.5 to 1660.5	DL: 1525 to 1559	✓
25	UL: 1850 to 1915	DL: 1930 to 1995	✓
26	UL: 814 to 849	DL: 859 to 894	✓
27	UL: 807 to 824	DL: 852 to 869	✓
28	UL: 703 to 748	DL: 758 to 803	✓
29	UL: -	DL: 717 to 728	✓
30	UL: 2305 to 2315	DL: 2350 to 2360	✓
31	UL: 452.5 to 457.5	DL: 462.5 to 467.5	✓
32	UL: -	DL: 1452 - 1496	✓
35		1850 to 1910	✓
38		2570 to 2620	✓
39		1880 to 1920	✓
40		2300 to 2400	✓
41		2496 to 2690	✓
42		3400 to 3600	✓
43		3600 to 3800	✓
48		3550 to 3700	✓
66	UL: 1710-1780	DL: 2110-2200	✓
71		617 to 698	✓
74/75/76		1427 to 1518	✓
77		3300 to 4200	✓
78		3300 to 3800	✓
79		4400 to 5000	✓
87		410 to 425	✓
88		412 to 427	✓

*Tested with 3m Cable in Free Space

3. Antenna Characteristics

3.1 Return Loss

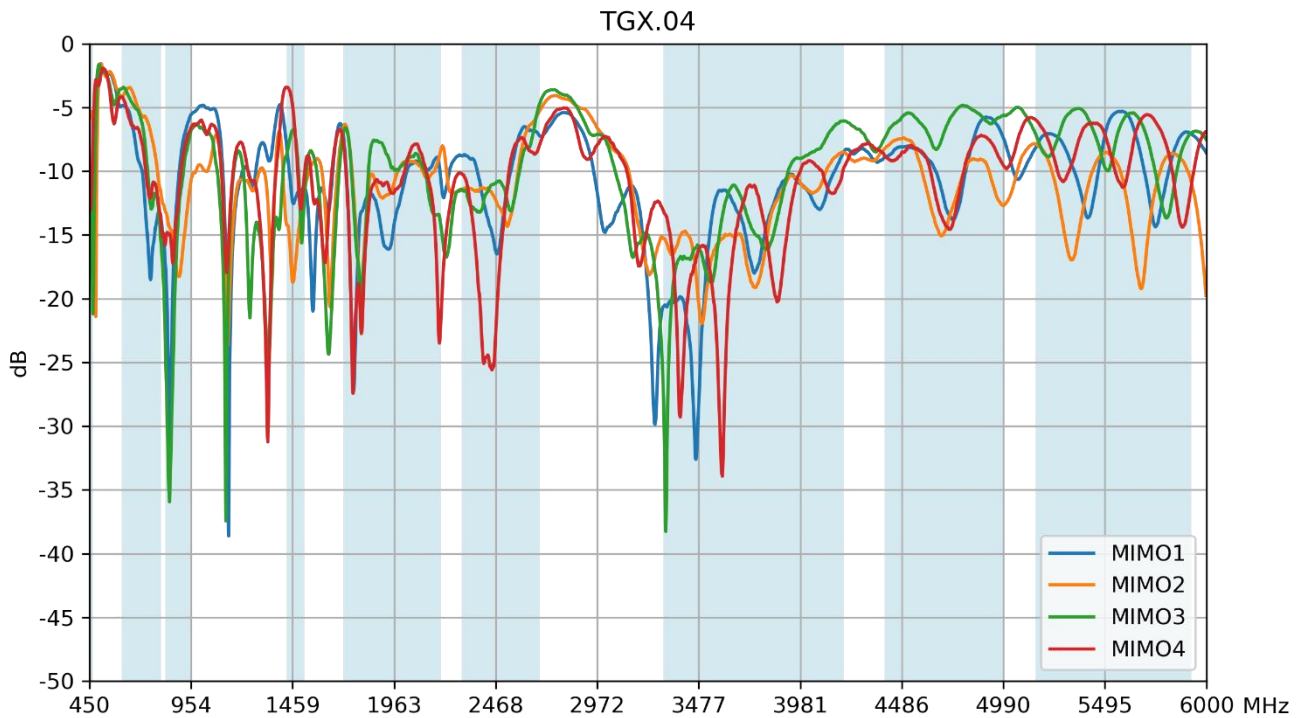

3.2 VSWR

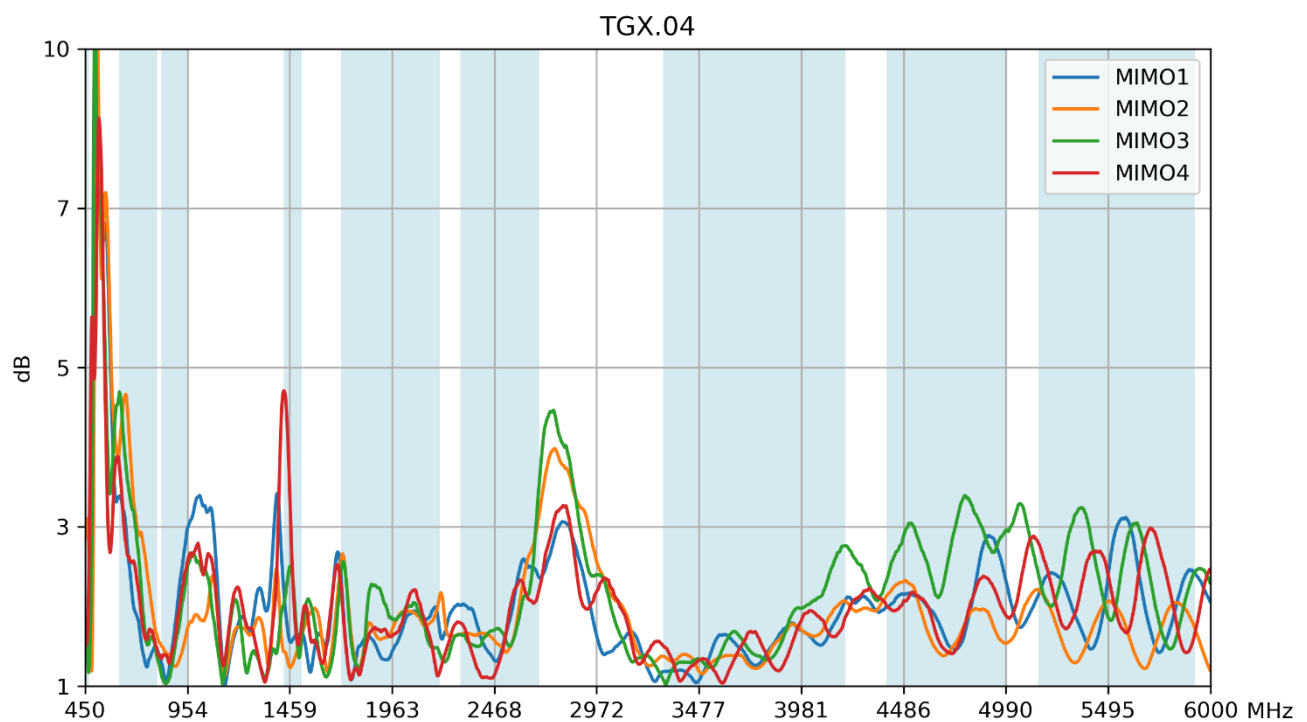

3.3 Isolation

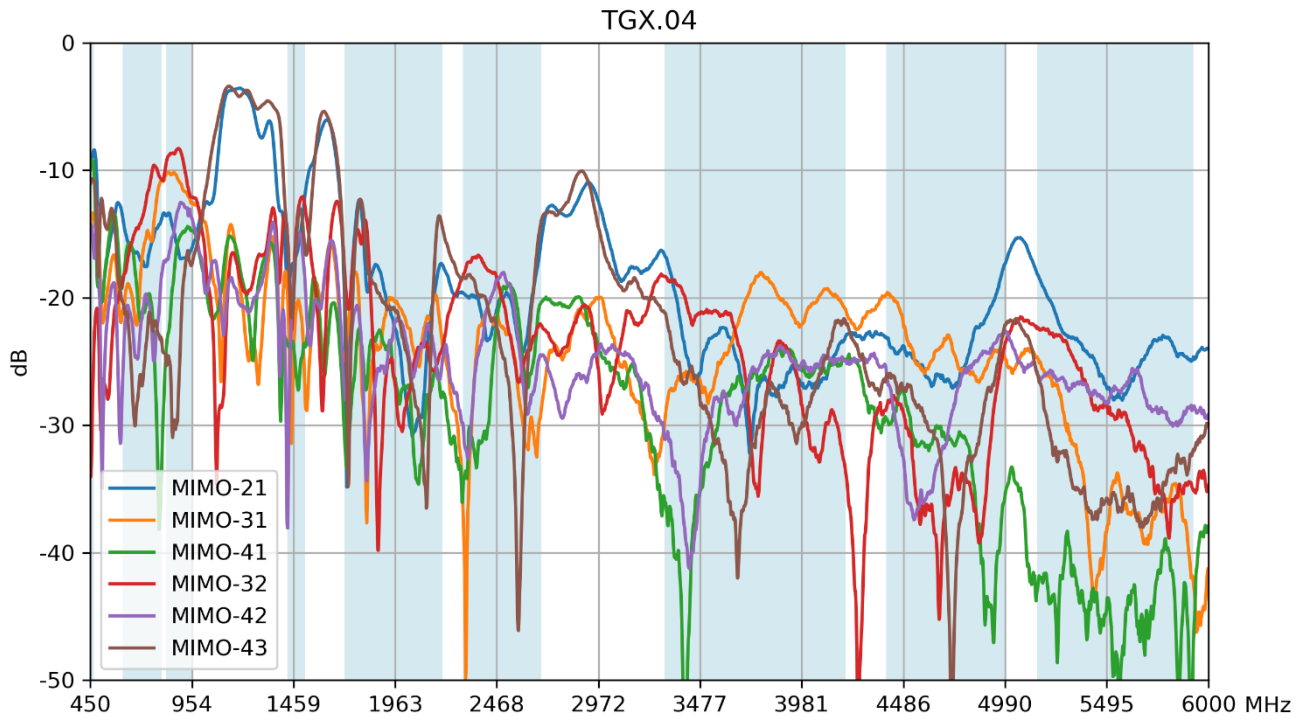

3.4 Efficiency

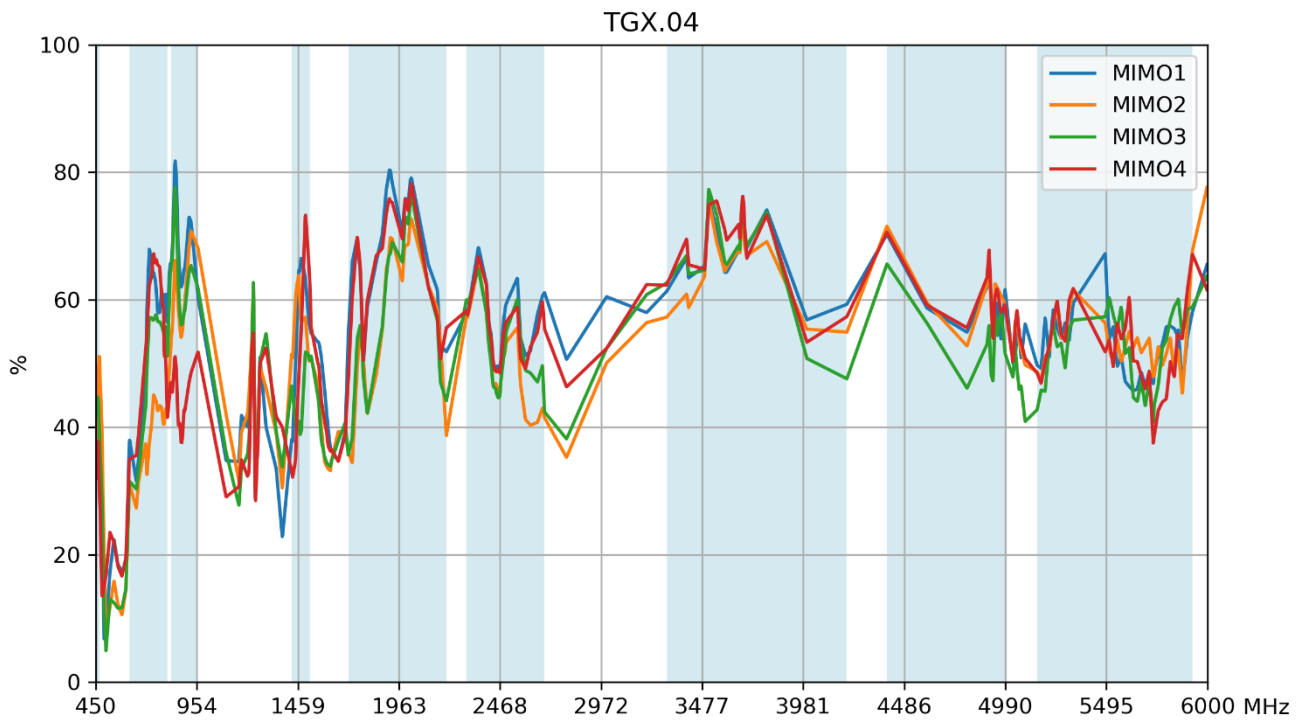

3.5 Peak Gain

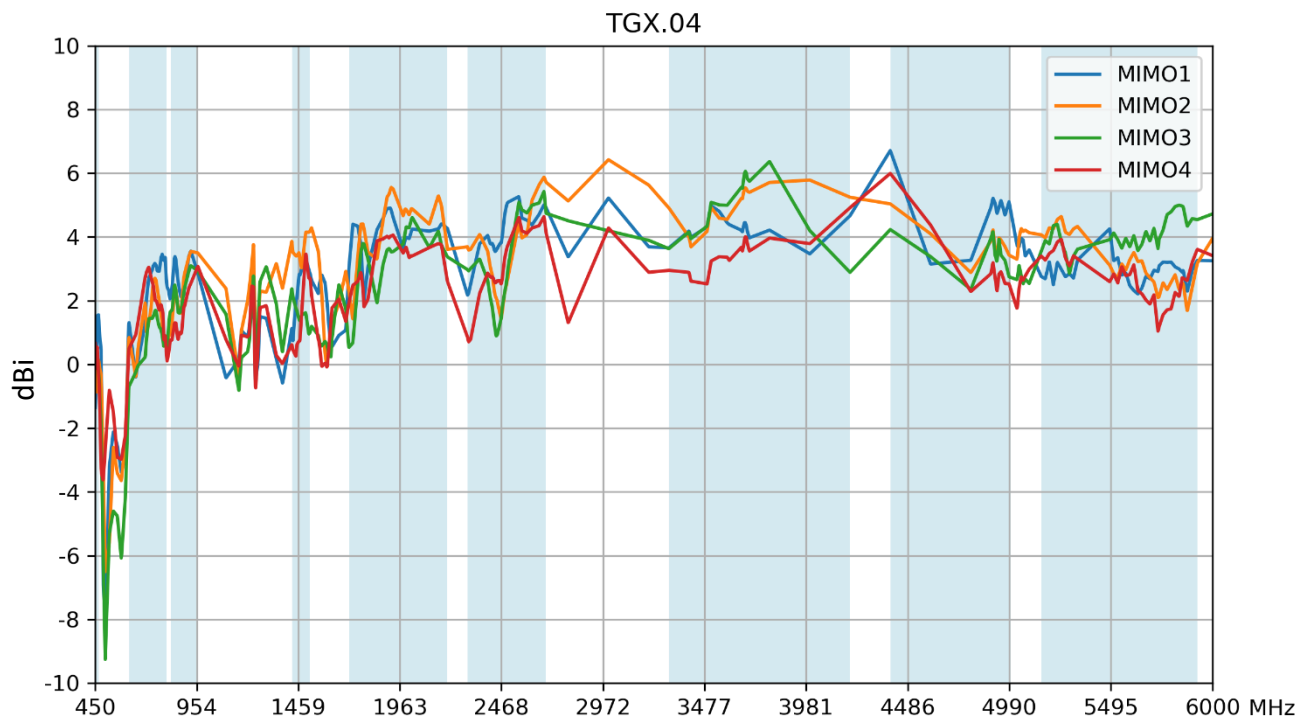

3.6 Average Gain

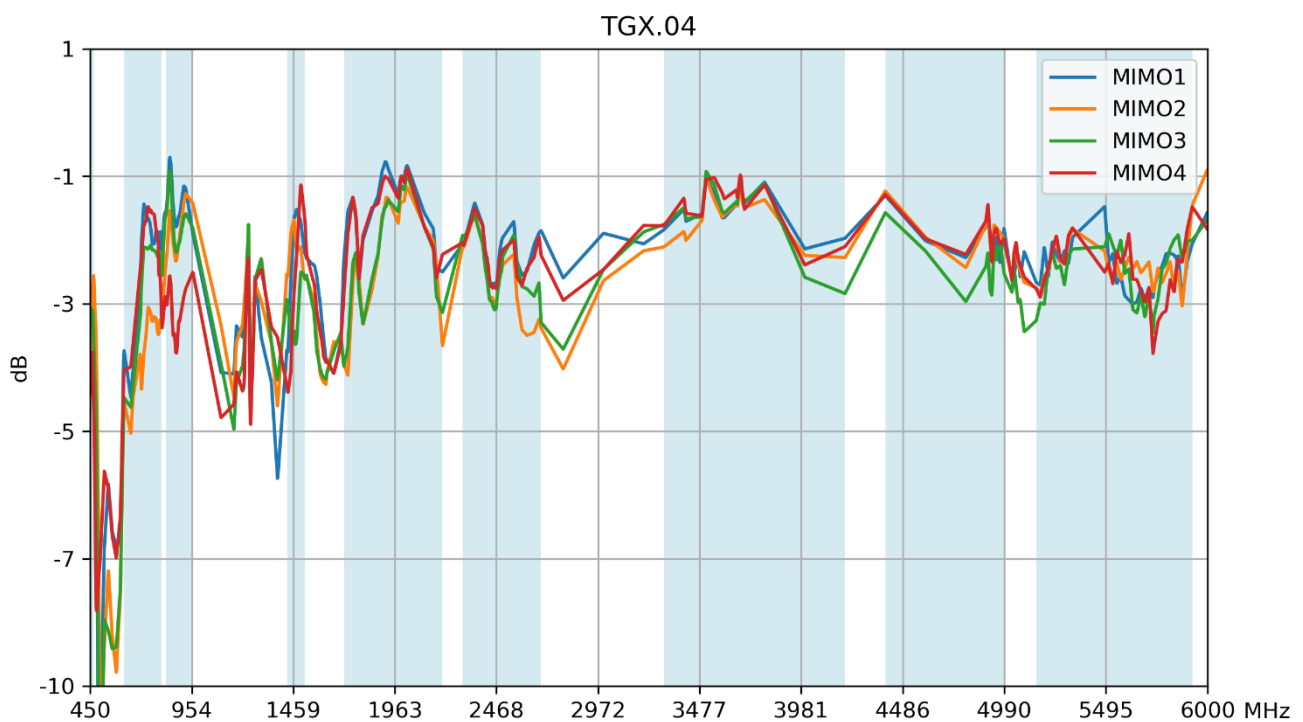

4. Radiation Patterns

4.1 Test Setup – in Free Space

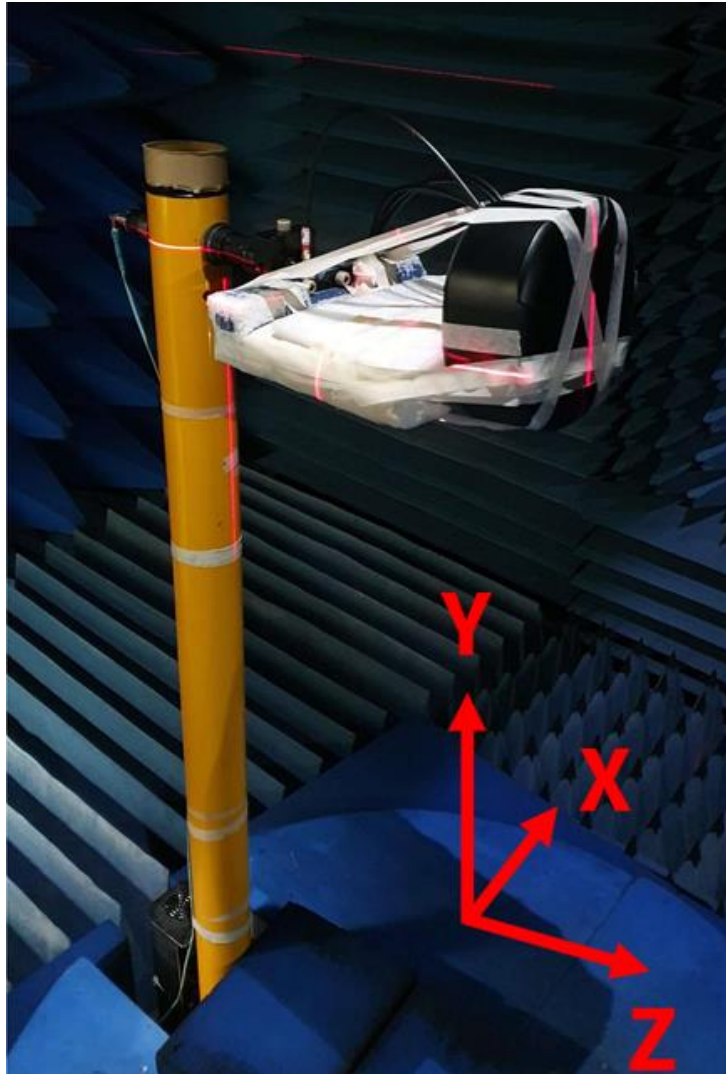

4.2 3D and 2D Radiation Patterns – MIMO 1

466MHz

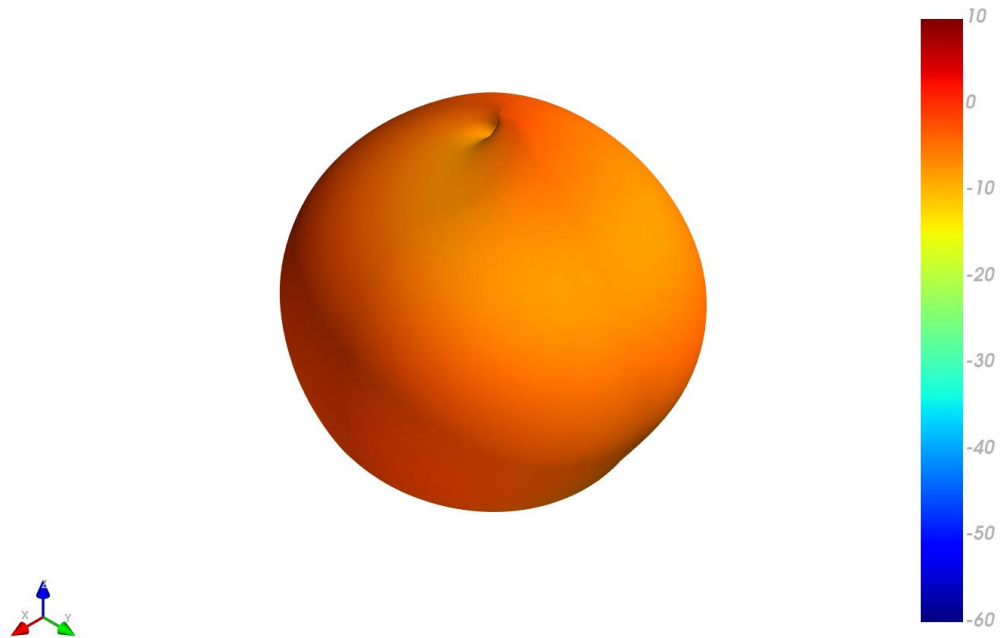

XY Plane XZ Plane YZ Plane

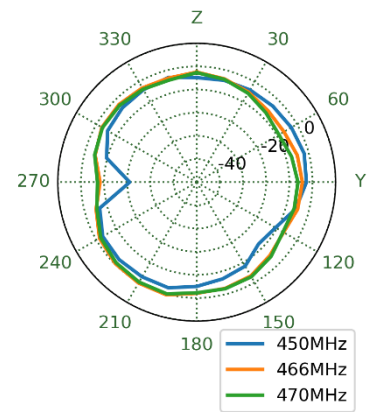
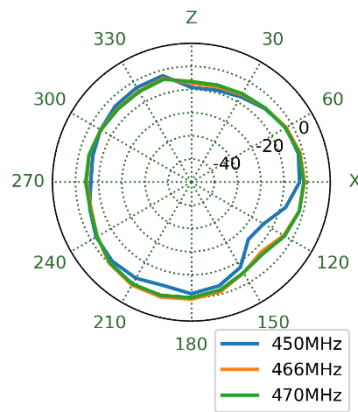
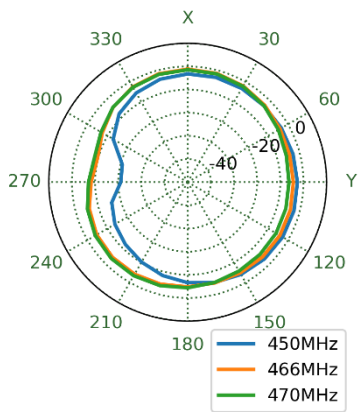

663MHz

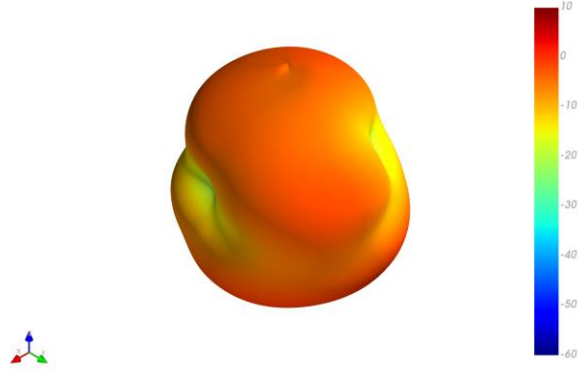

XY Plane

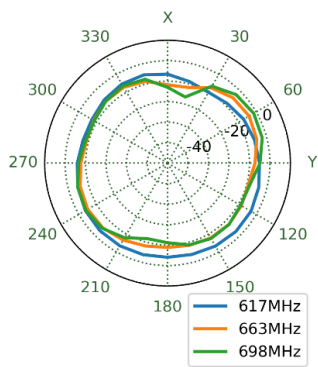

XZ Plane

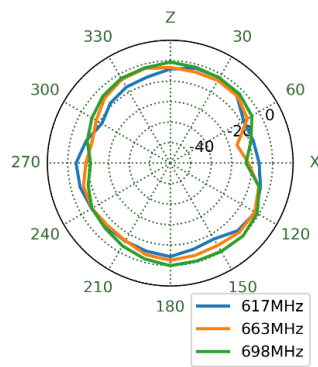

YZ Plane

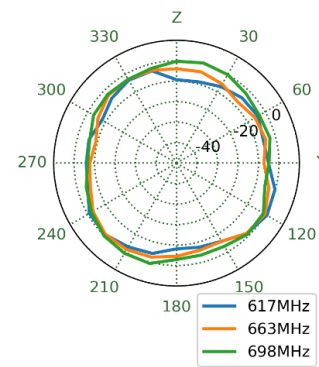

751MHz

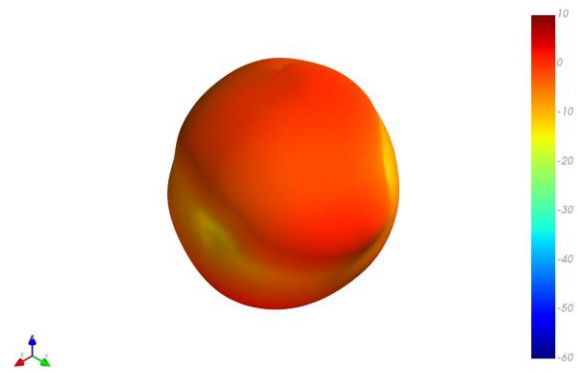

XY Plane

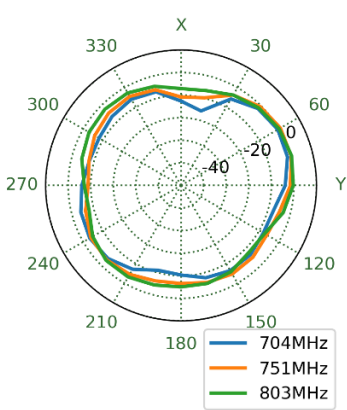

XZ Plane

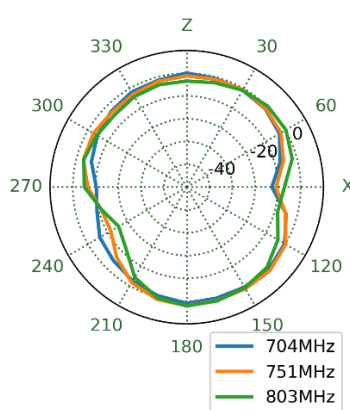

YZ Plane

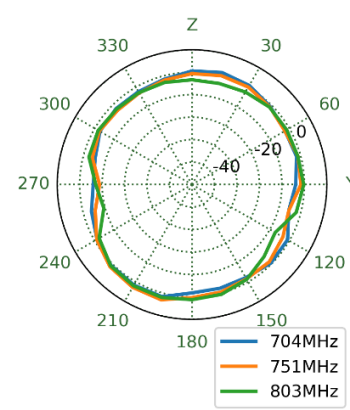

860MHz

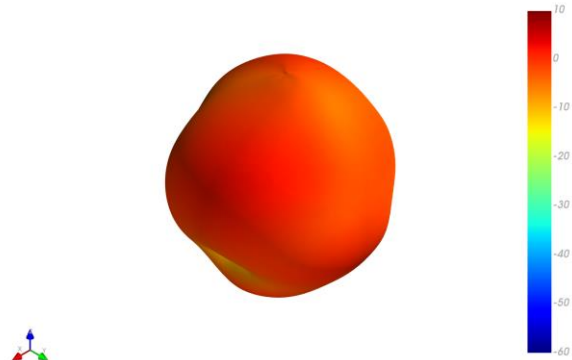

XY Plane

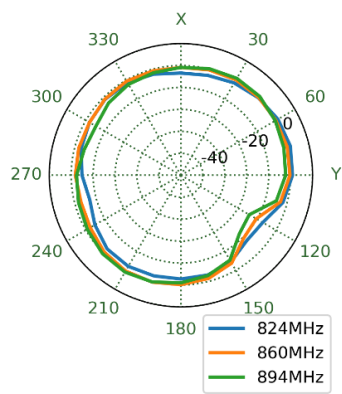

XZ Plane

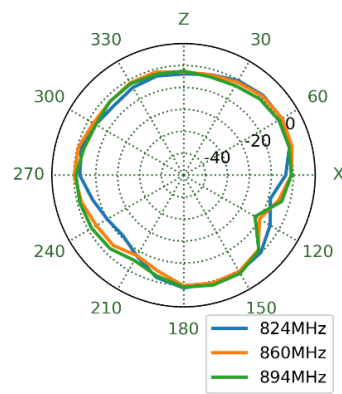

YZ Plane

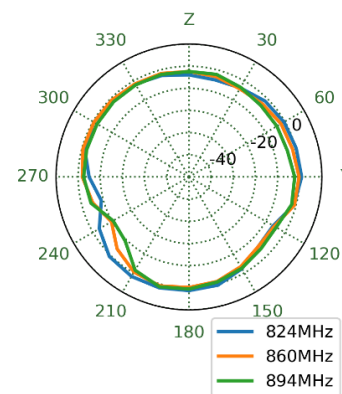

915MHz

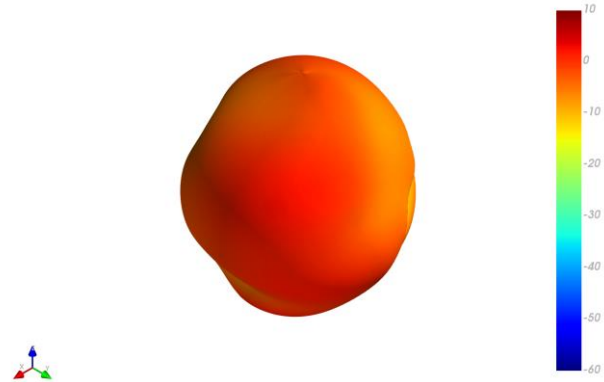

XY Plane

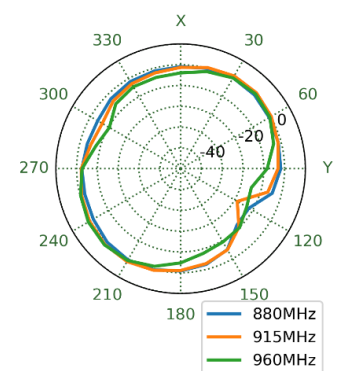

XZ Plane

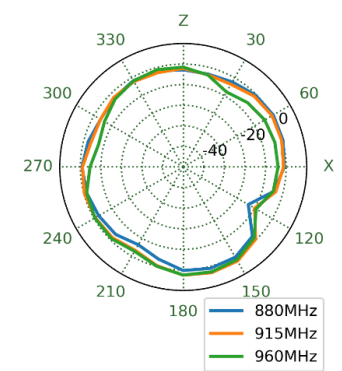

YZ Plane

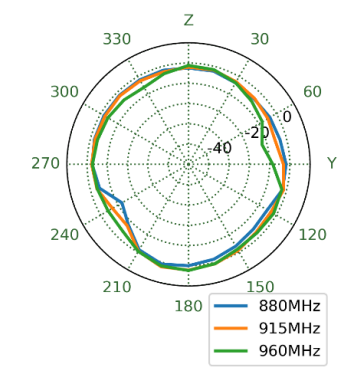

1475MHz

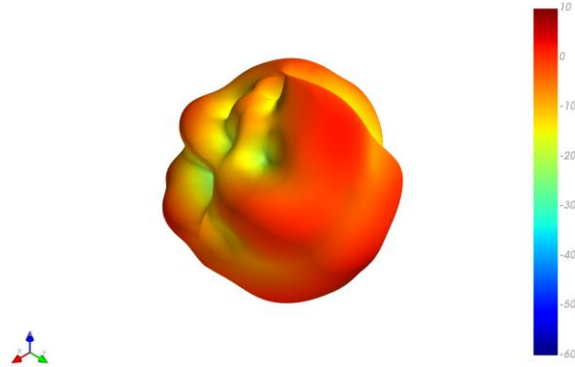

XY Plane

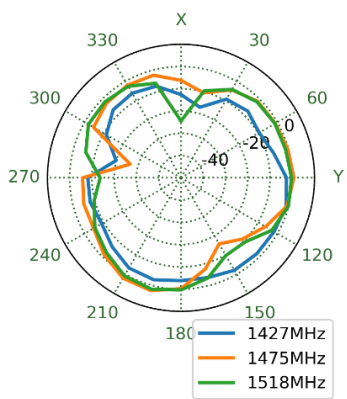

XZ Plane

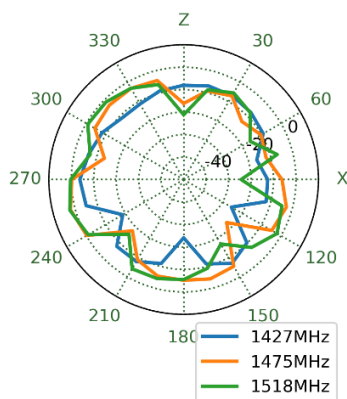

YZ Plane

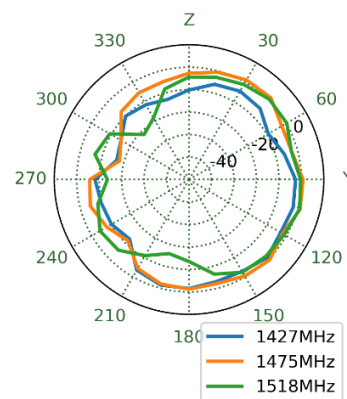

1770MHz

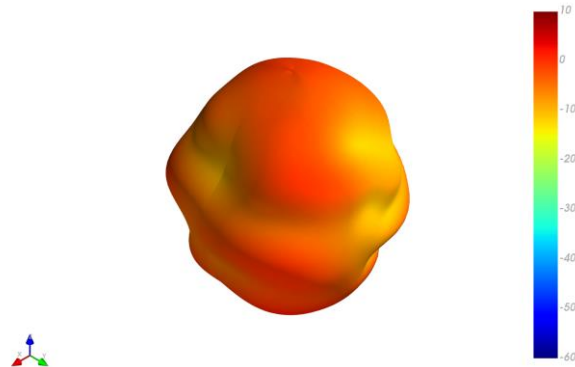

XY Plane

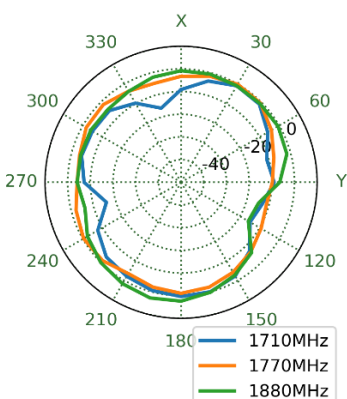

XZ Plane

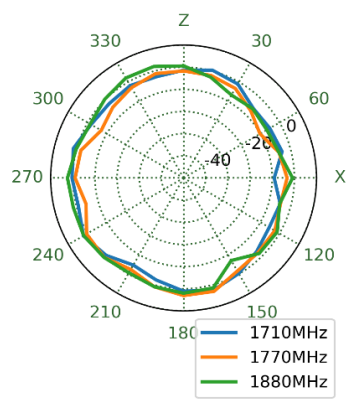

YZ Plane

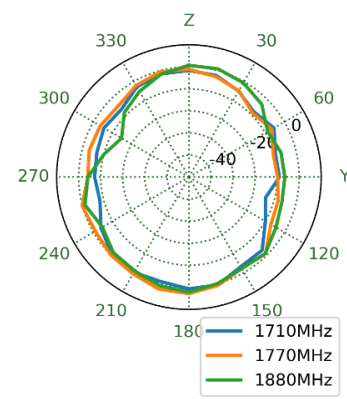

1910MHz

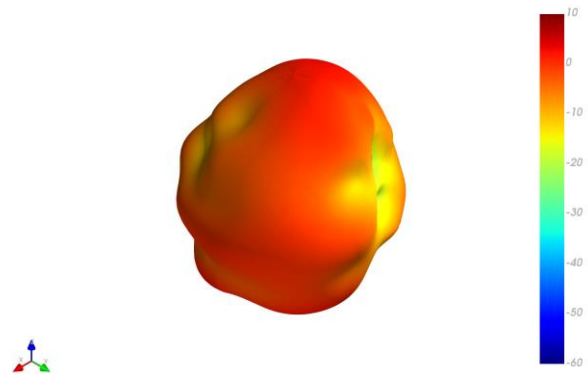

XY Plane

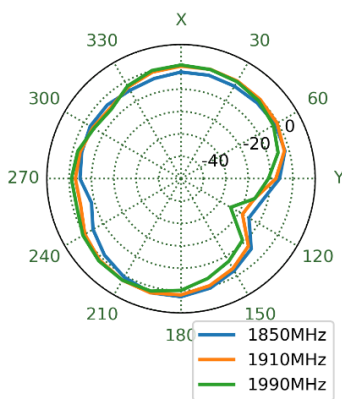

XZ Plane

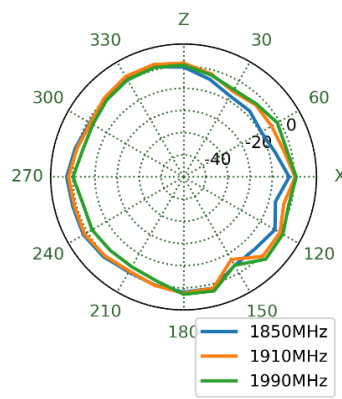

YZ Plane

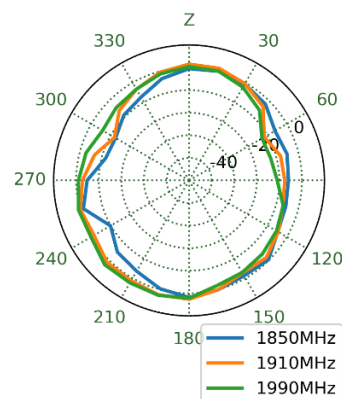

2110MHz

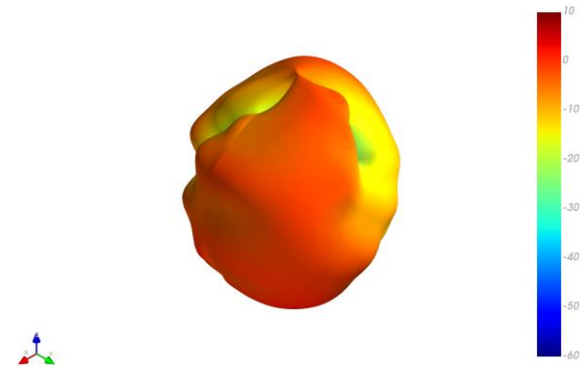

XY Plane

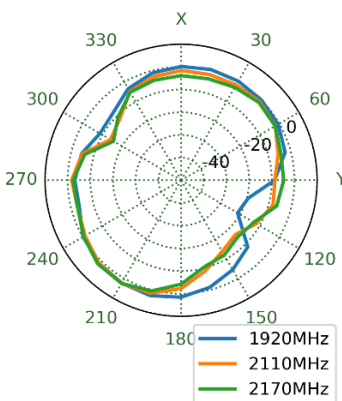

XZ Plane

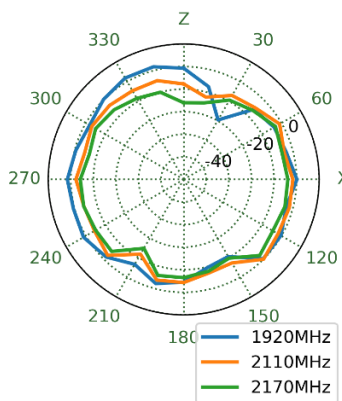

YZ Plane

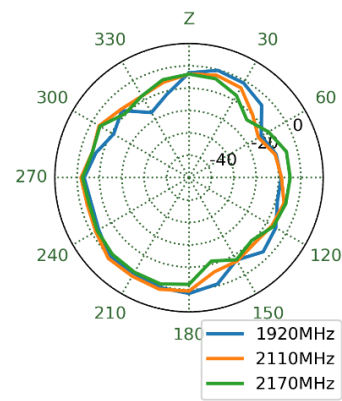

2570MHz

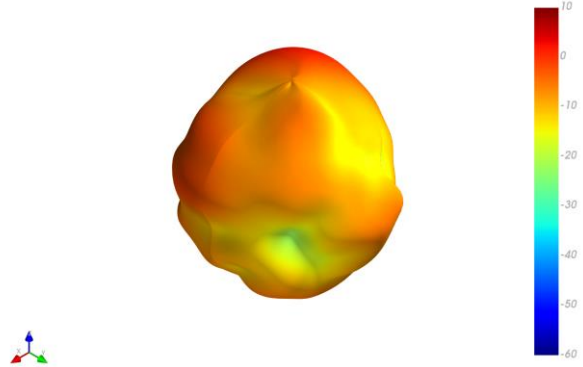

XY Plane

XZ Plane

YZ Plane

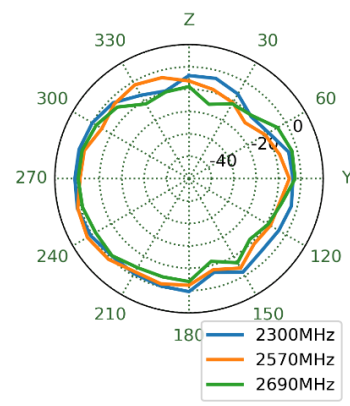
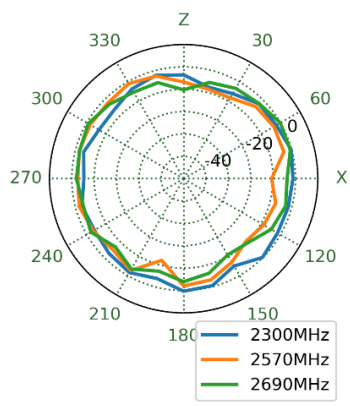
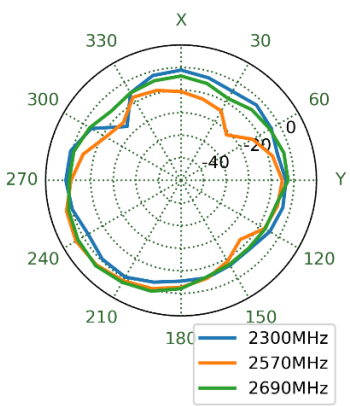

3400MHz

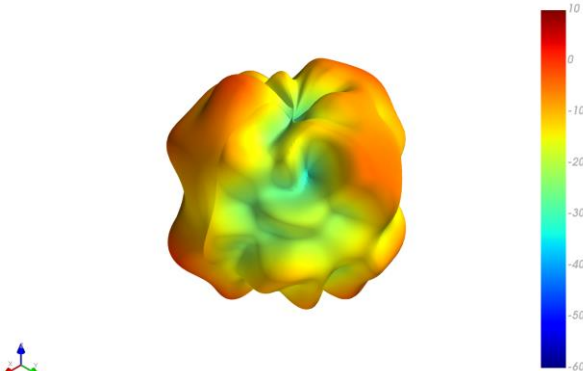

XY Plane

XZ Plane

YZ Plane

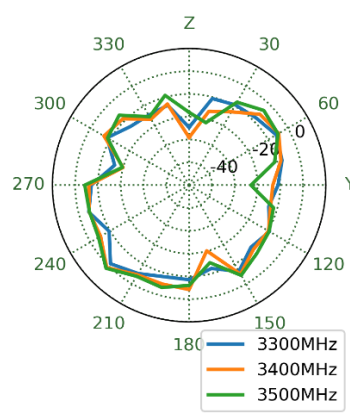
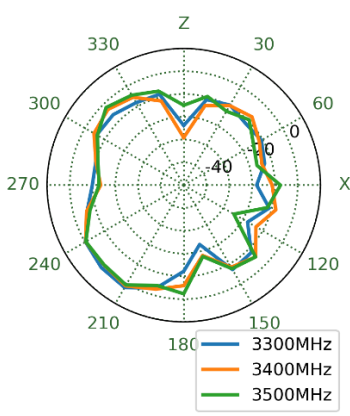
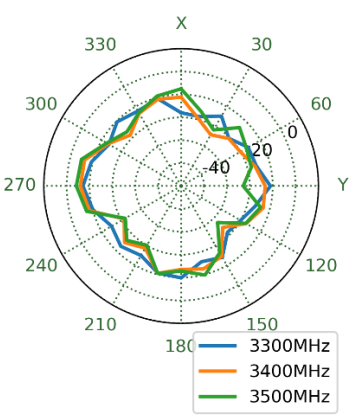

3700MHz

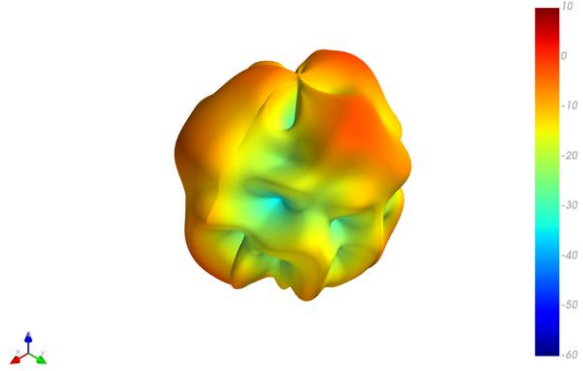

XY Plane

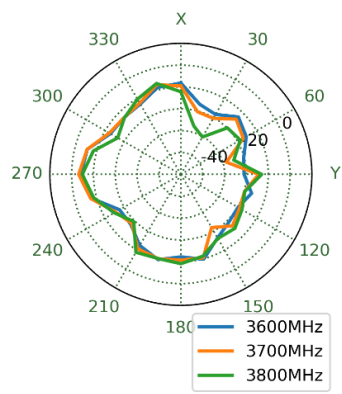

XZ Plane

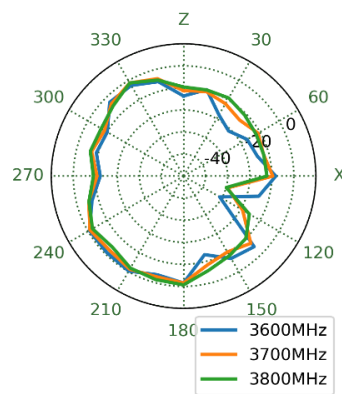

YZ Plane

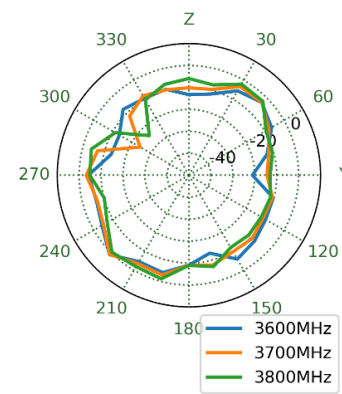

4000MHz

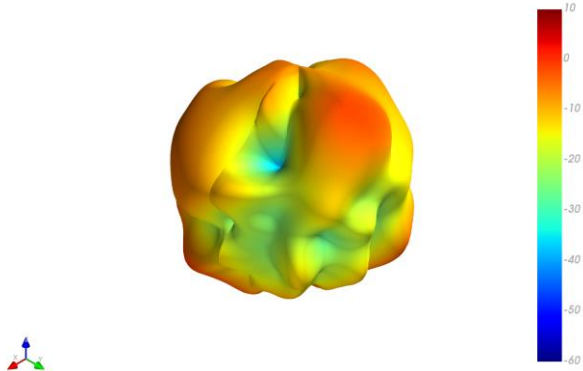

XY Plane

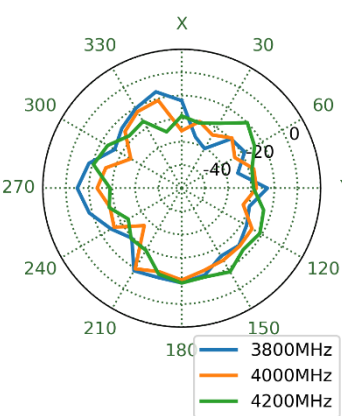

XZ Plane

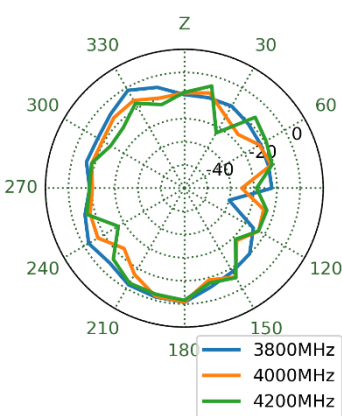

YZ Plane

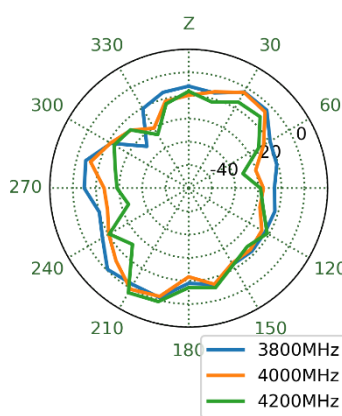

4400MHz

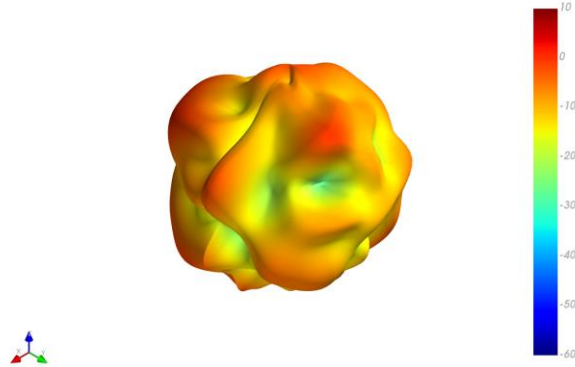

XY Plane

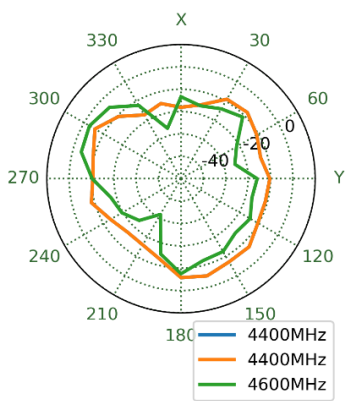

XZ Plane

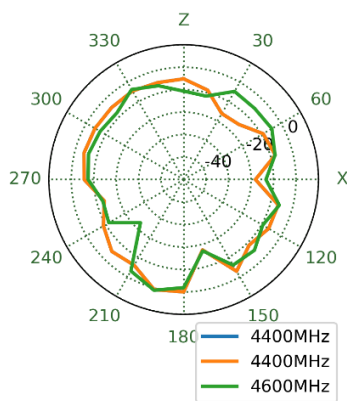

YZ Plane

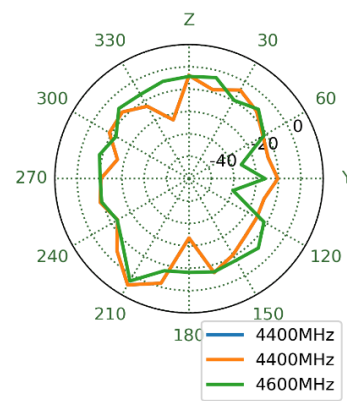

4800MHz

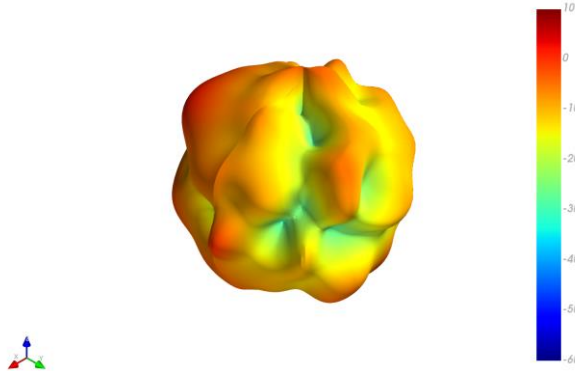

XY Plane

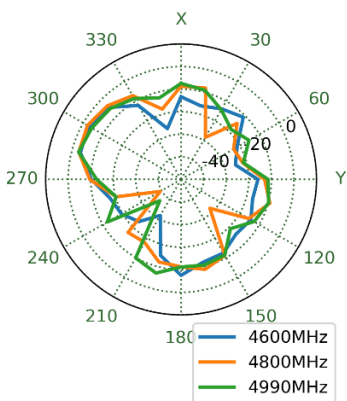

XZ Plane

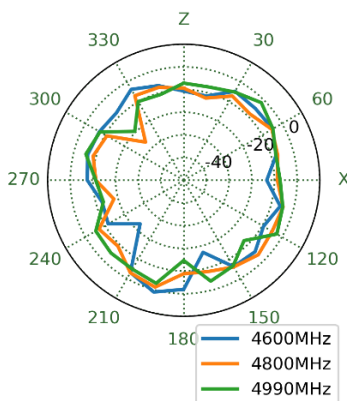

YZ Plane

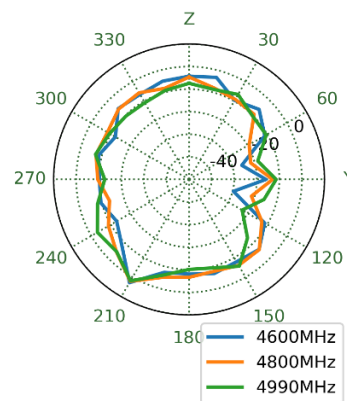

5570MHz

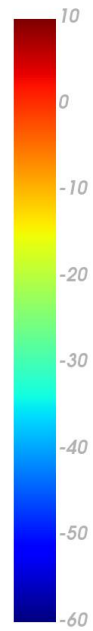
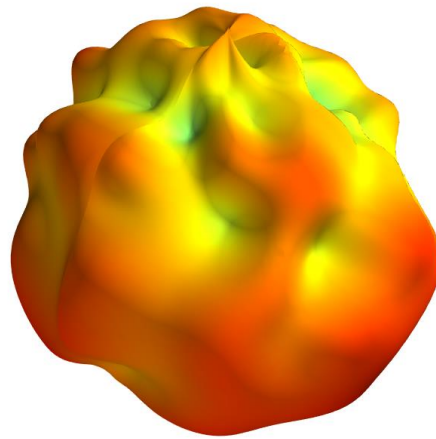

XY Plane

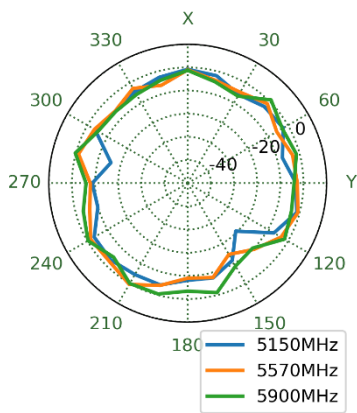

XZ Plane

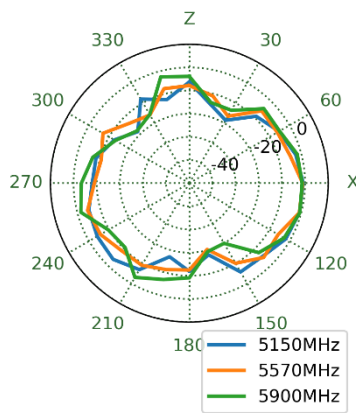

YZ Plane

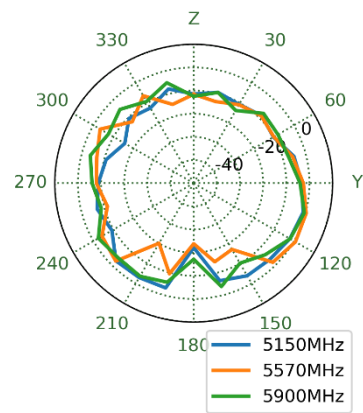

4.3 3D and 2D Radiation Patterns – MIMO 2

466MHz

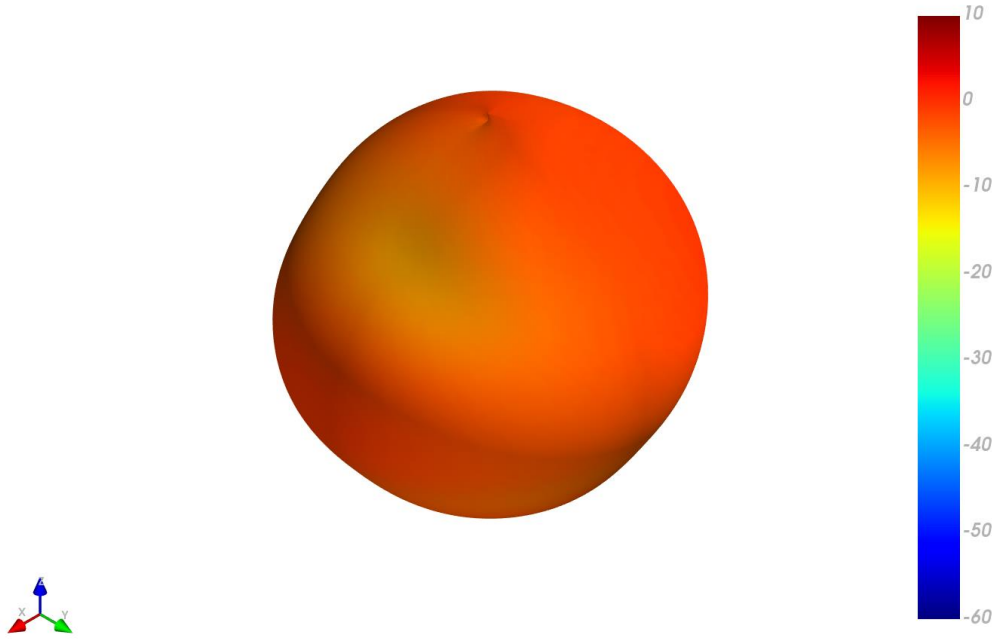

XY Plane

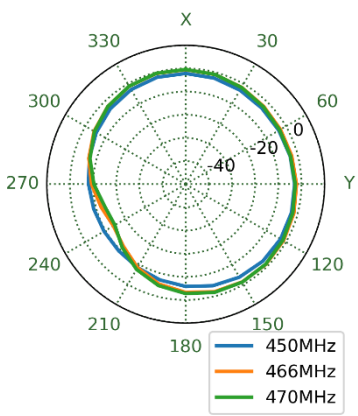

XZ Plane

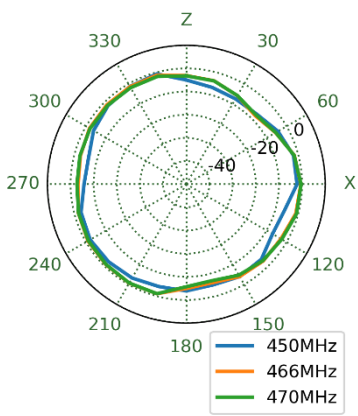

YZ Plane

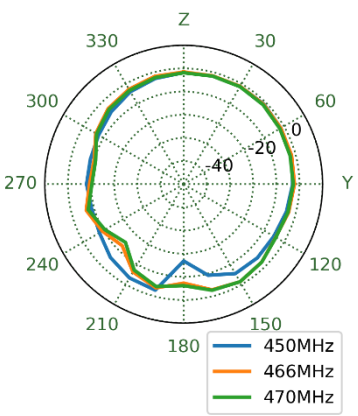

663MHz

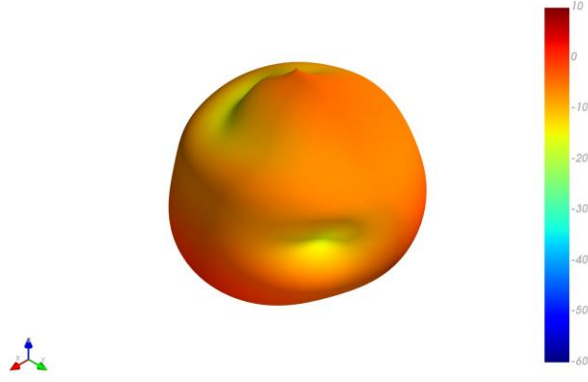

XY Plane
XZ Plane
YZ Plane

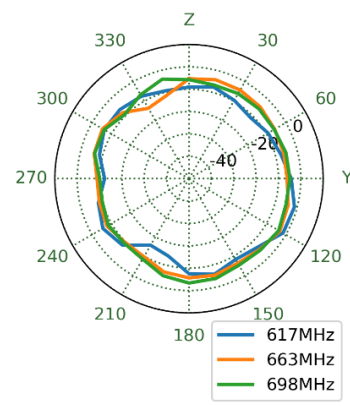
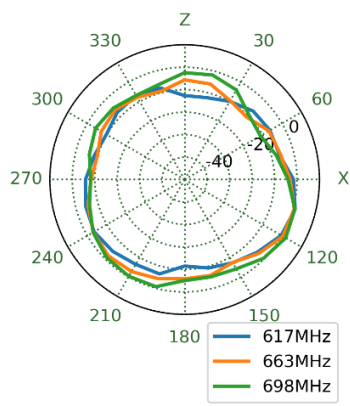
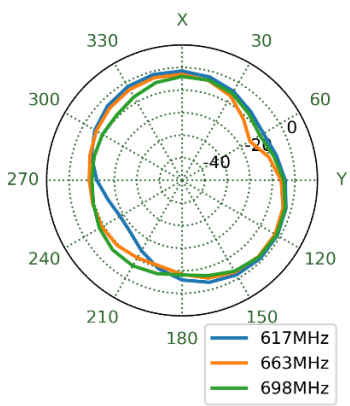

751MHz

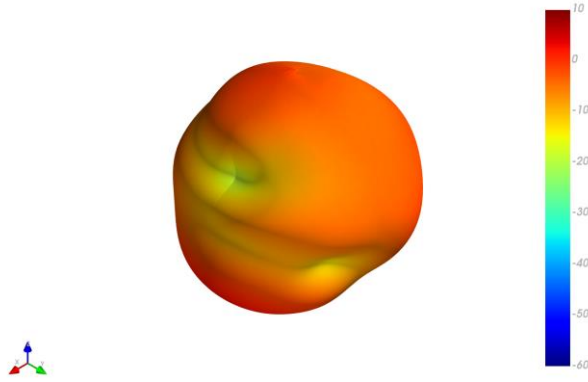

XY Plane
XZ Plane
YZ Plane

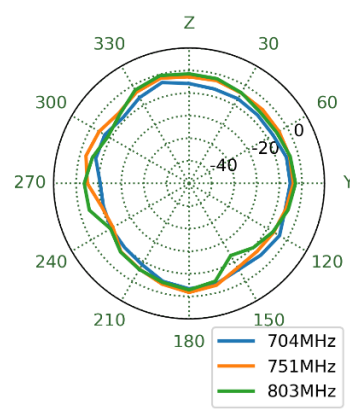
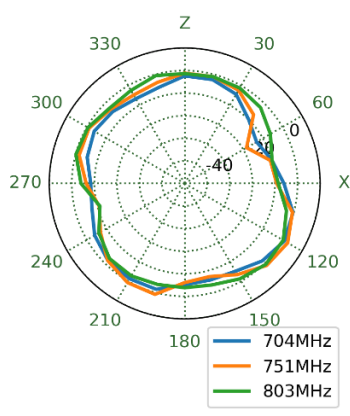
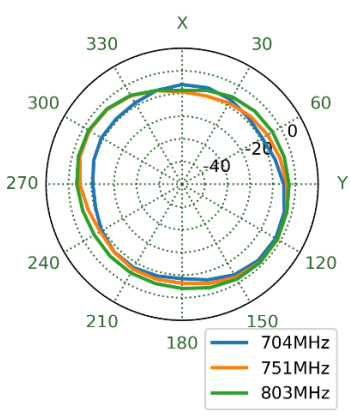

860MHz

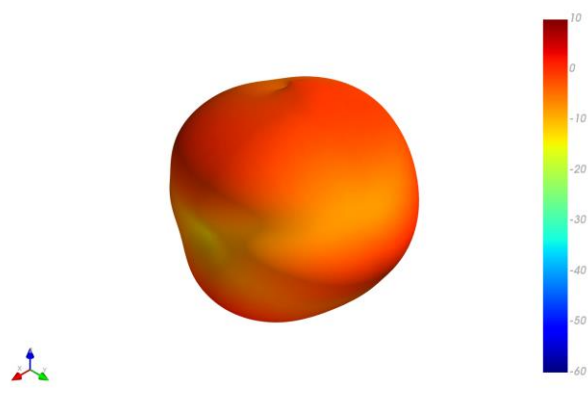

XY Plane

XZ Plane

YZ Plane

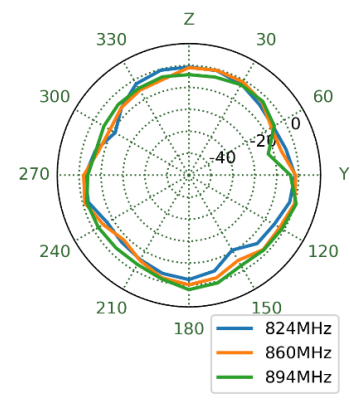
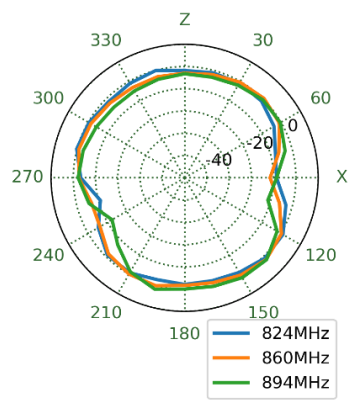
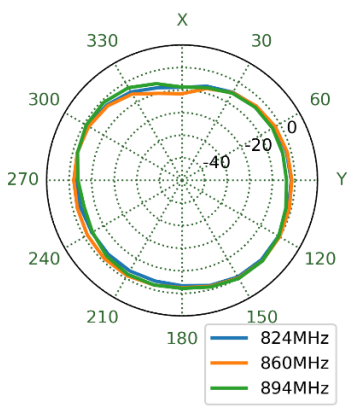

915MHz

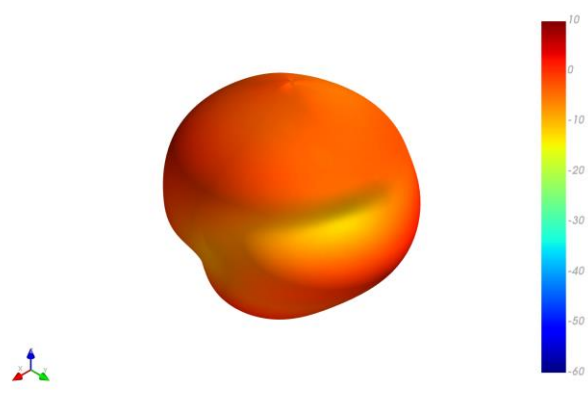

XY Plane

XZ Plane

YZ Plane

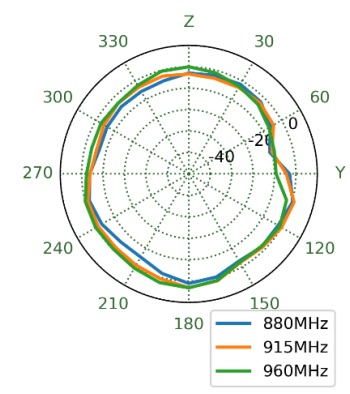
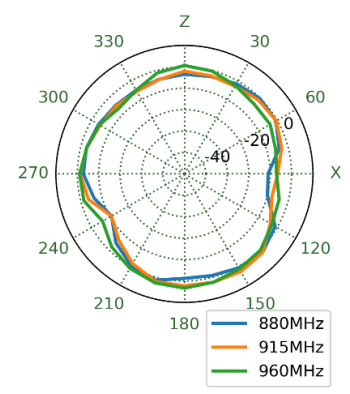
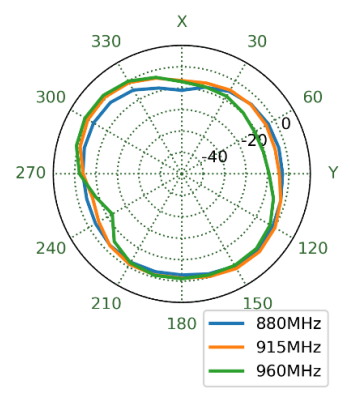

1475MHz

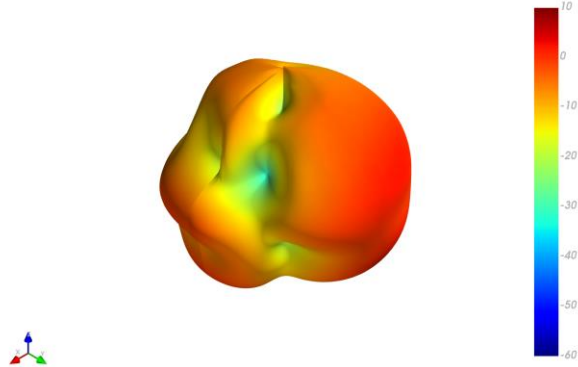

XY Plane

XZ Plane

YZ Plane

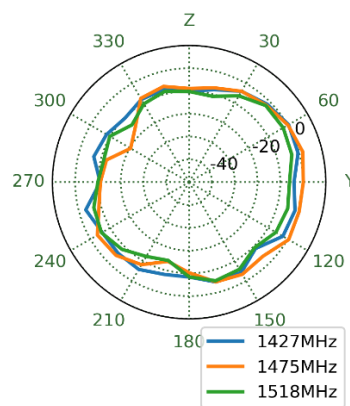
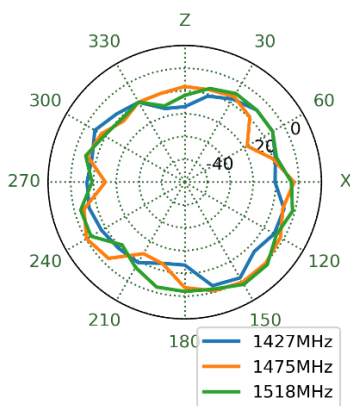
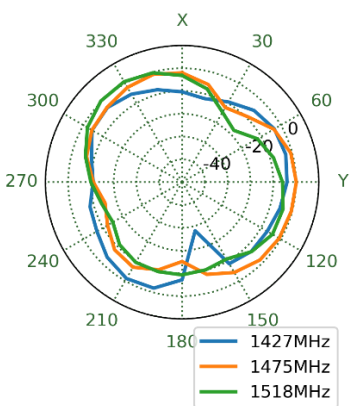

1770MHz

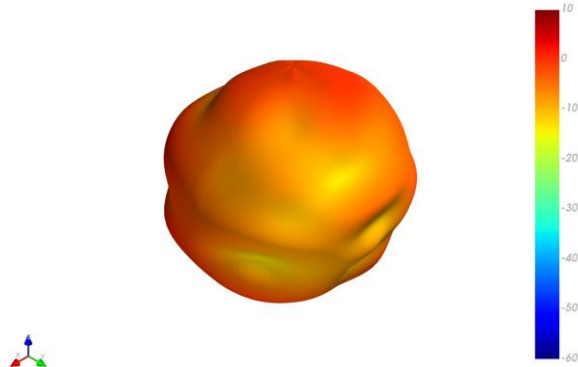

XY Plane

XZ Plane

YZ Plane

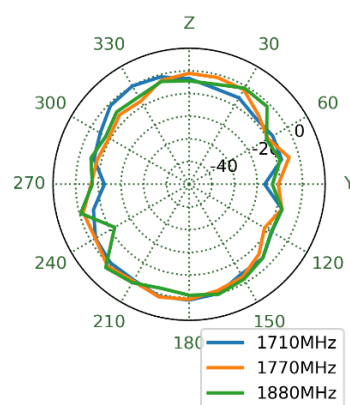
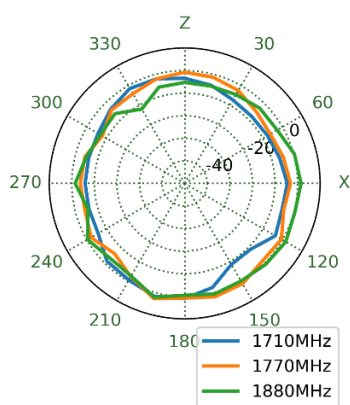
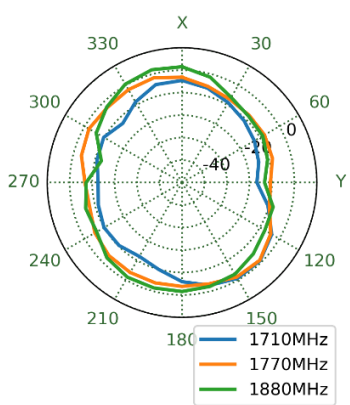

1910MHz

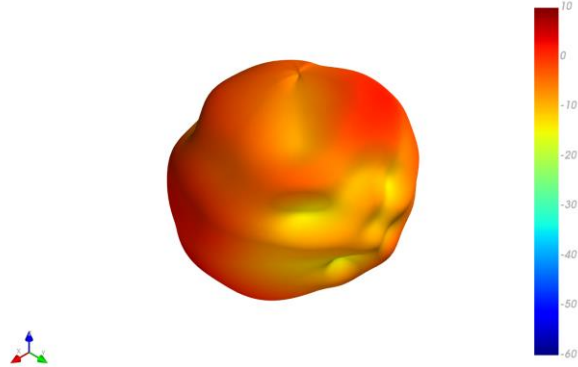

XY Plane

XZ Plane

YZ Plane

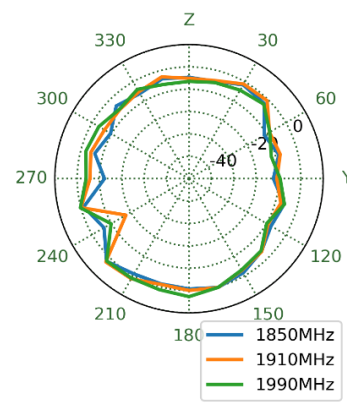
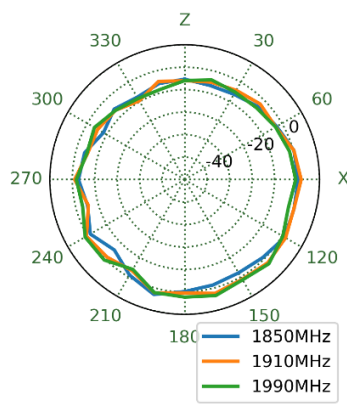
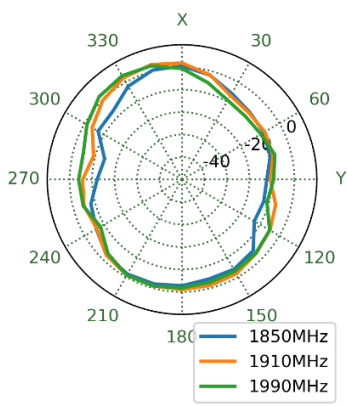

2110MHz

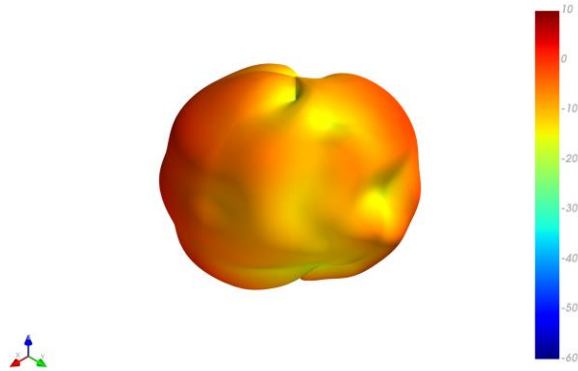

XY Plane

XZ Plane

YZ Plane

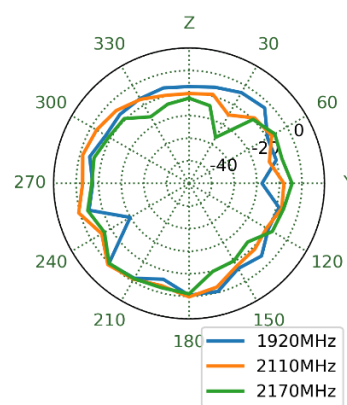
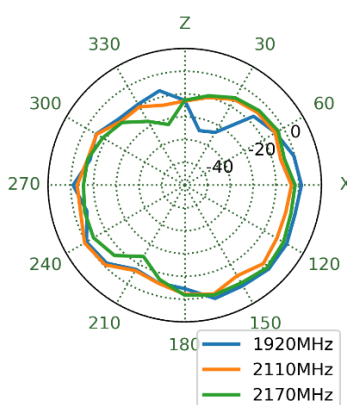
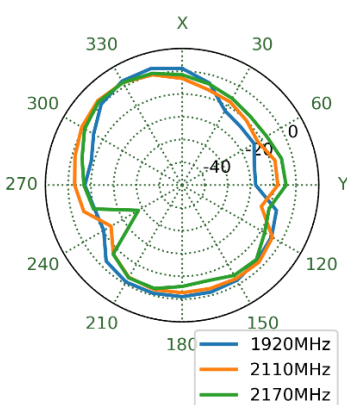

2570MHz

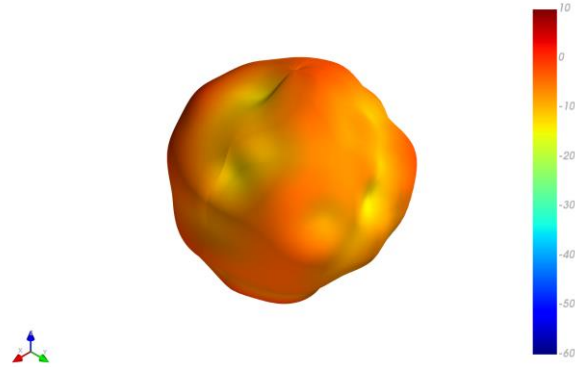

XY Plane

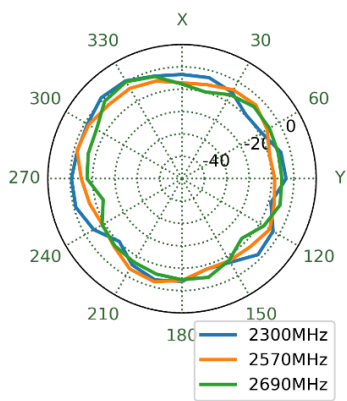

XZ Plane

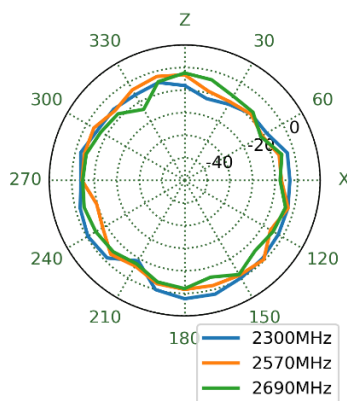

YZ Plane

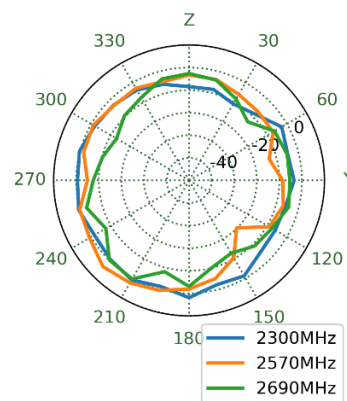

3400MHz

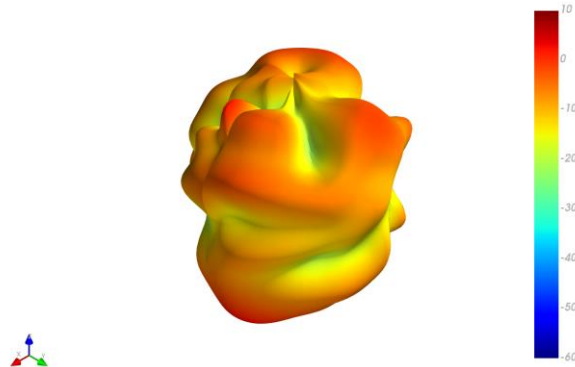

XY Plane

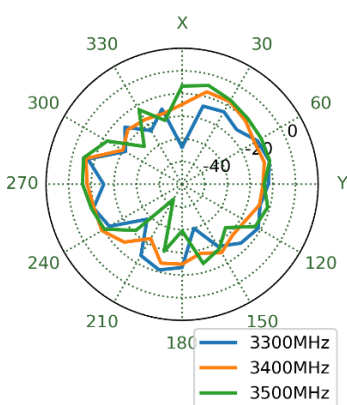

XZ Plane

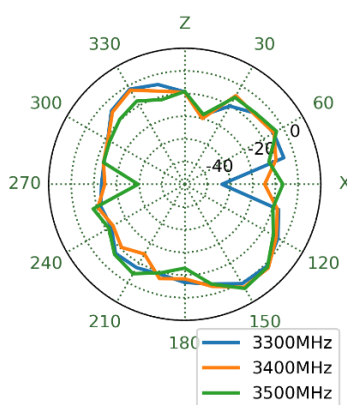

YZ Plane

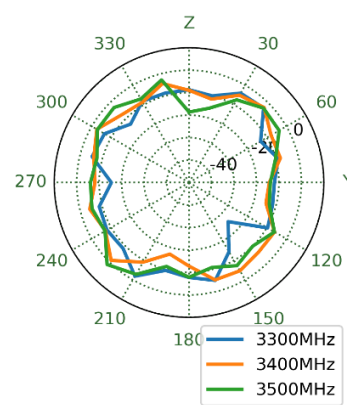

3700MHz

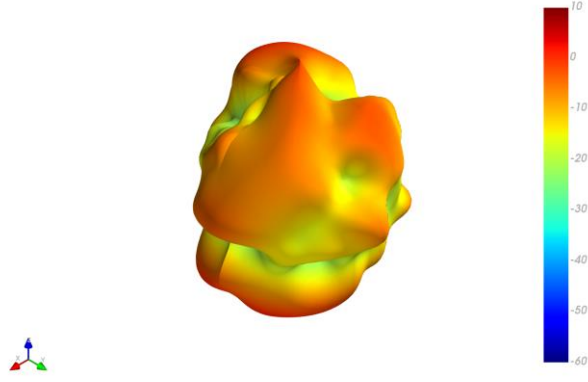

XY Plane

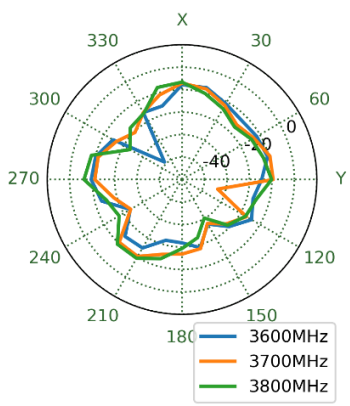

XZ Plane

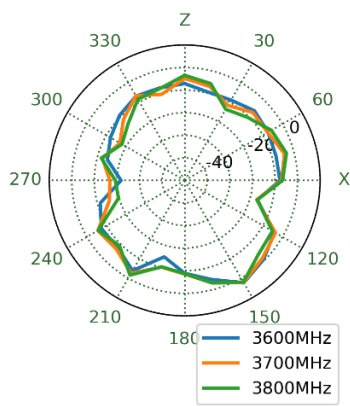

YZ Plane

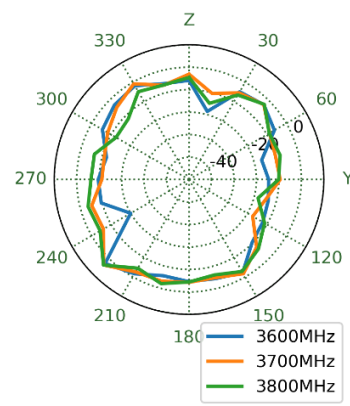

4000MHz

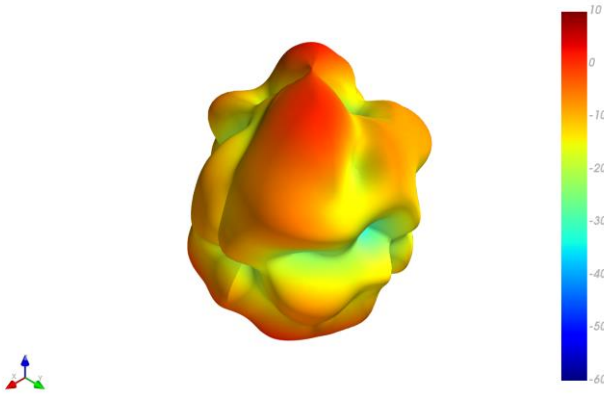

XY Plane

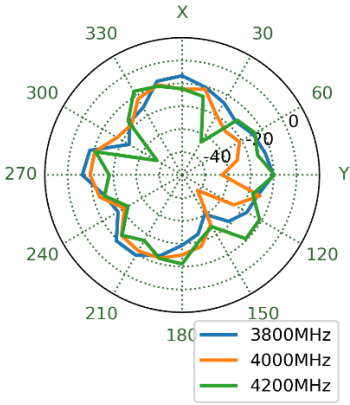

XZ Plane

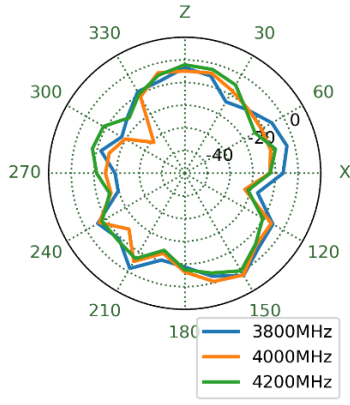

YZ Plane

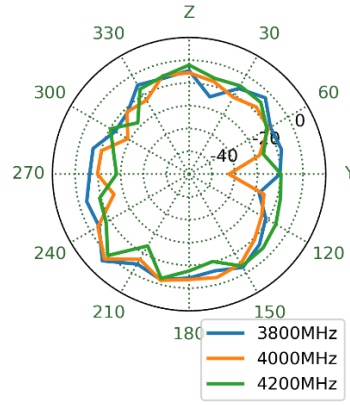

4400MHz

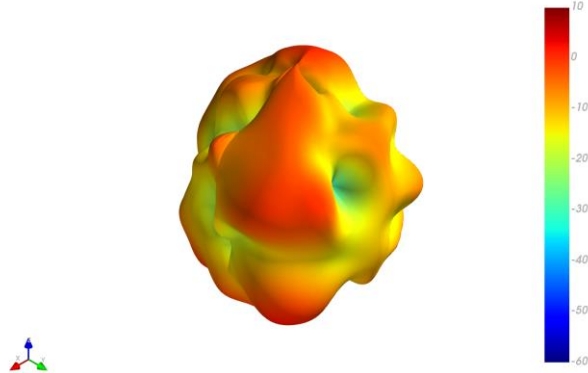

XY Plane

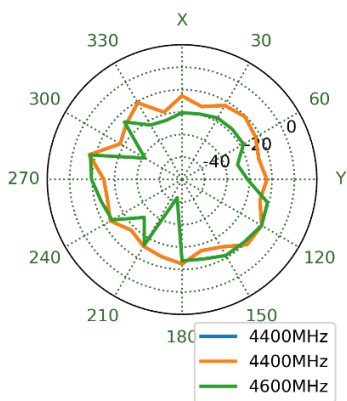

XZ Plane

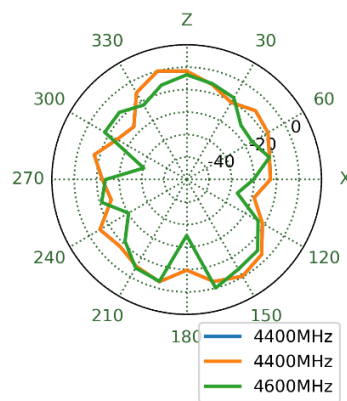

YZ Plane

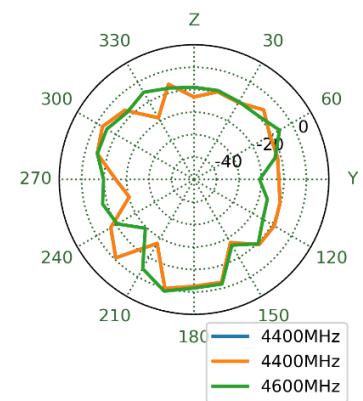

4800MHz

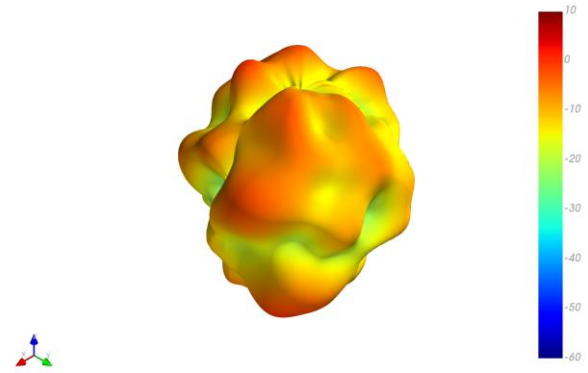

XY Plane

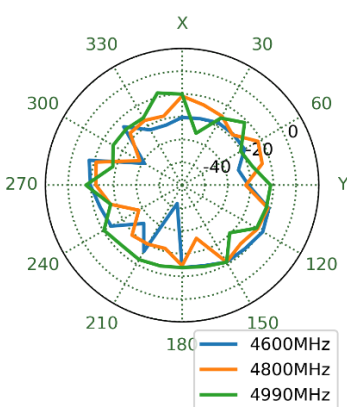

XZ Plane

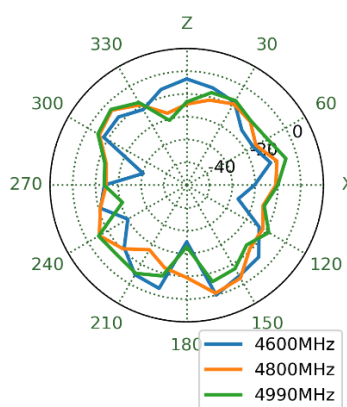

YZ Plane

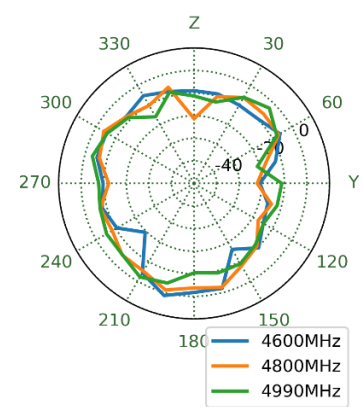

5570MHz

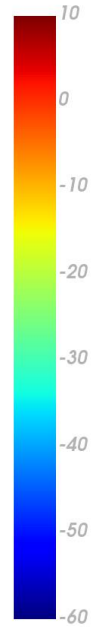
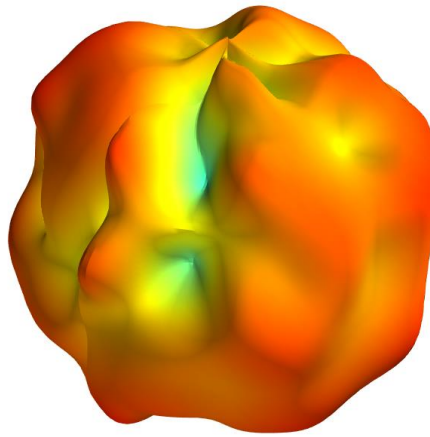

XY Plane

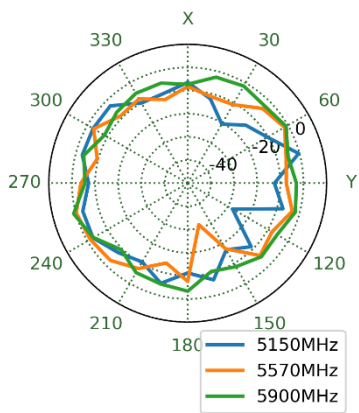

XZ Plane

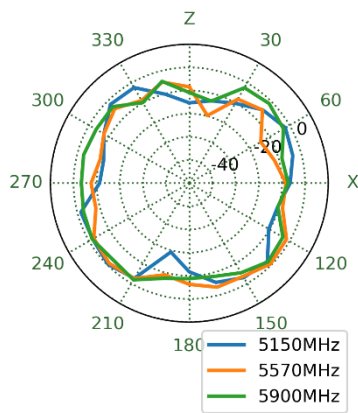

YZ Plane

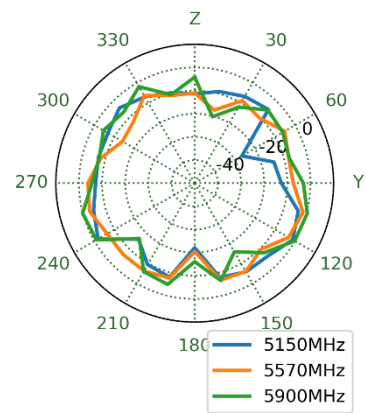

4.4 3D and 2D Radiation Patterns – MIMO 3

466MHz

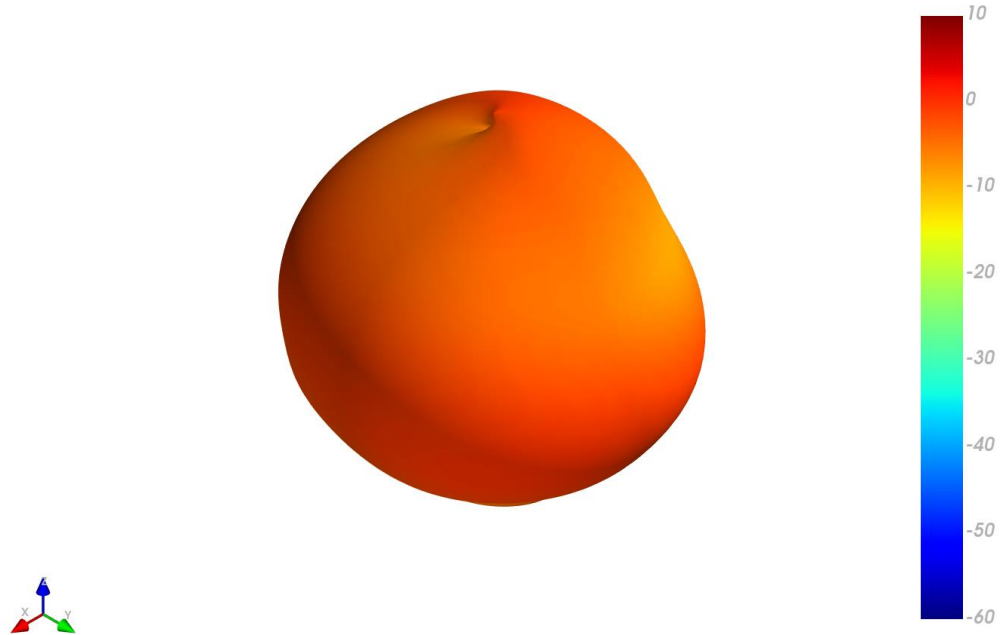

XY Plane

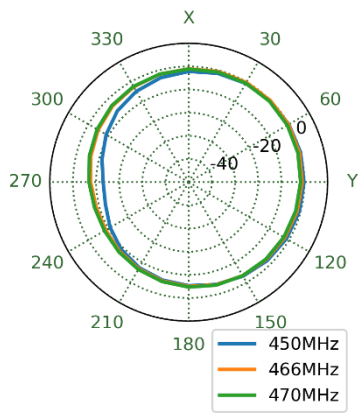

XZ Plane

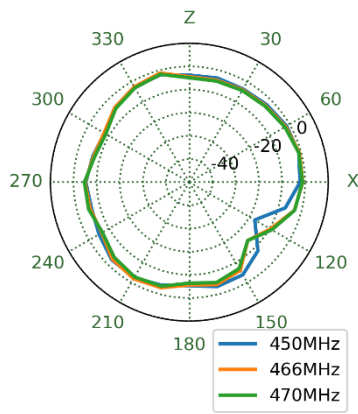

YZ Plane

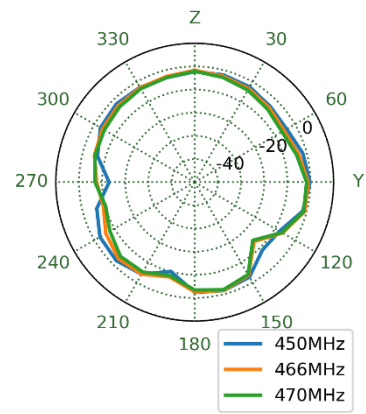

663MHz

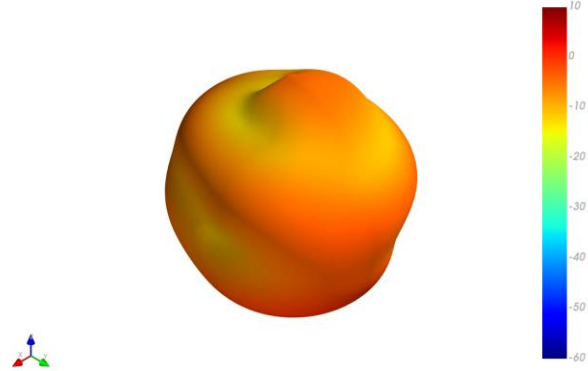

XY Plane

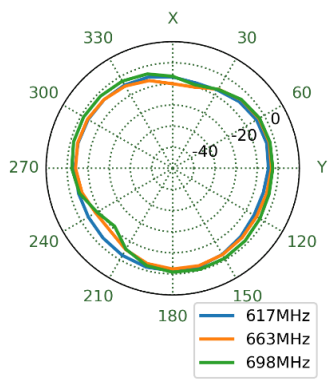

XZ Plane

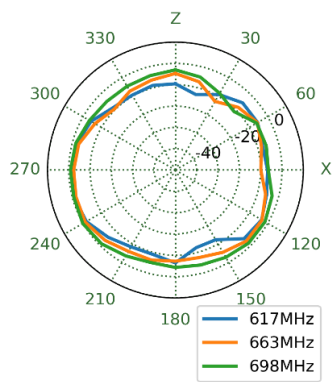

YZ Plane

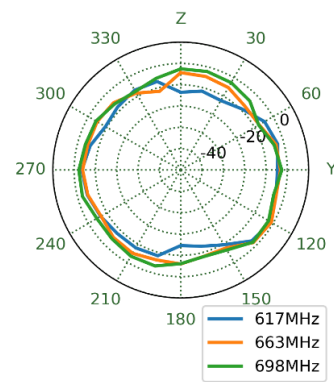

751MHz

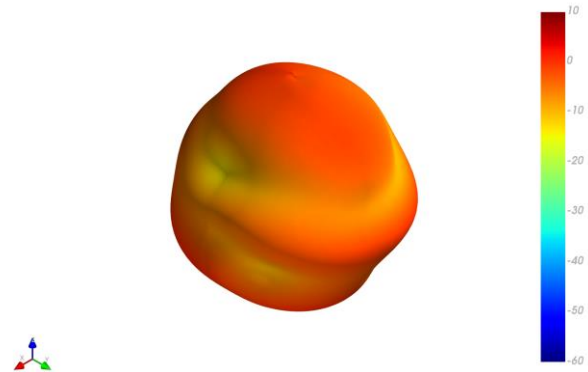

XY Plane

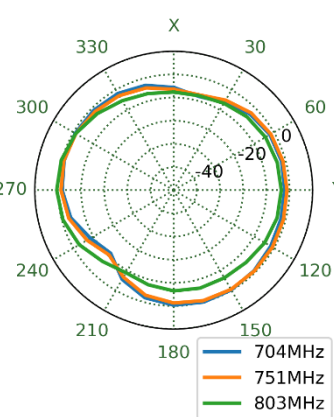

XZ Plane

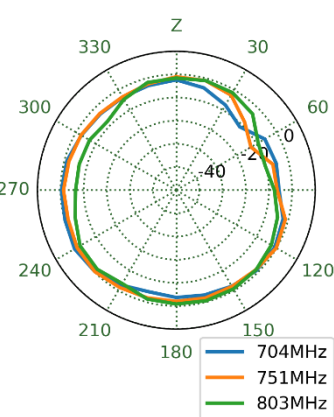

YZ Plane

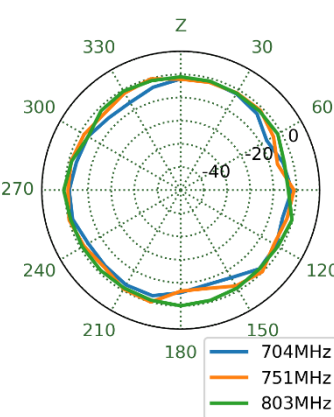

860MHz

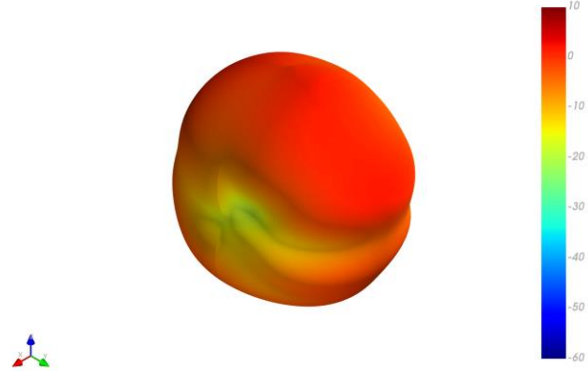

XY Plane

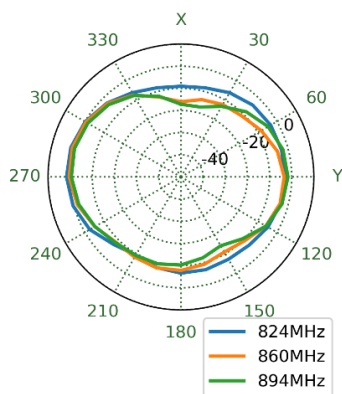

XZ Plane

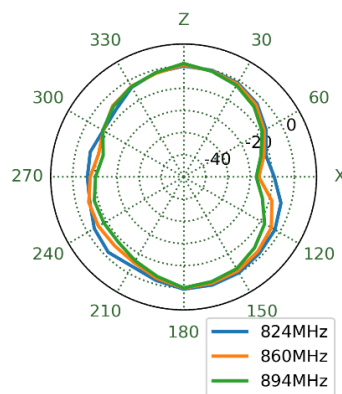

YZ Plane

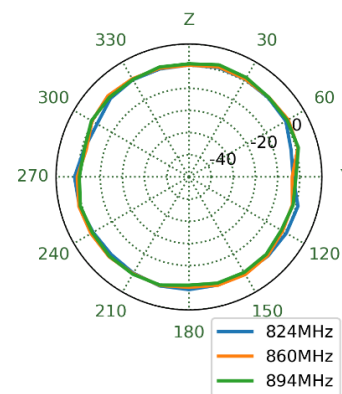

915MHz

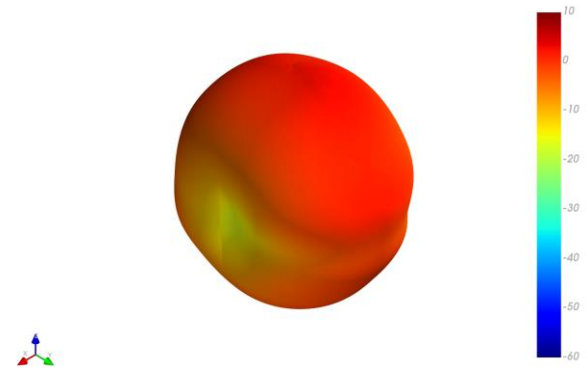

XY Plane

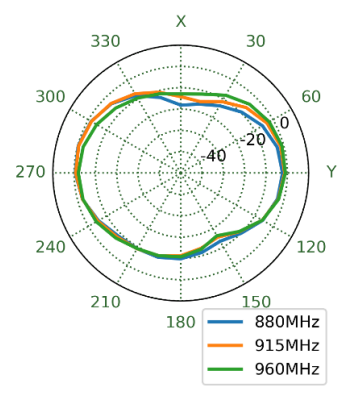

XZ Plane

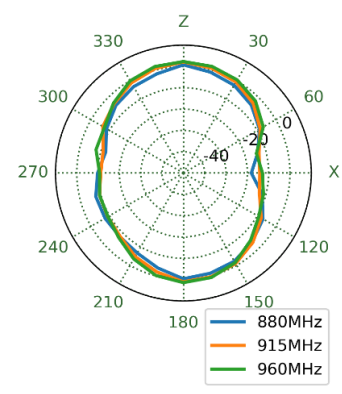

YZ Plane

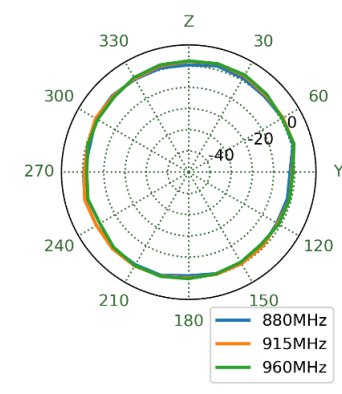

1475MHz

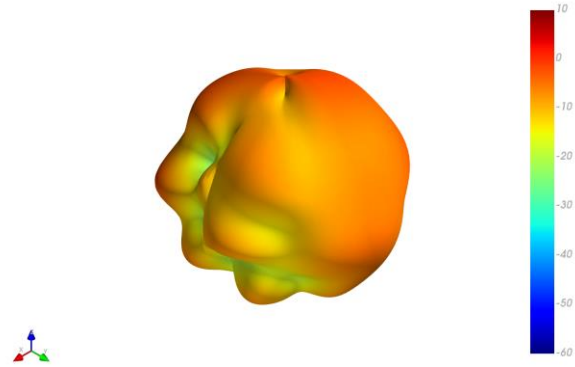

XY Plane

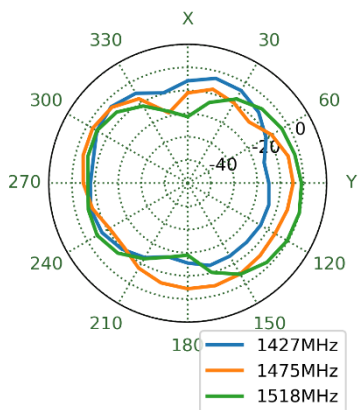

XZ Plane

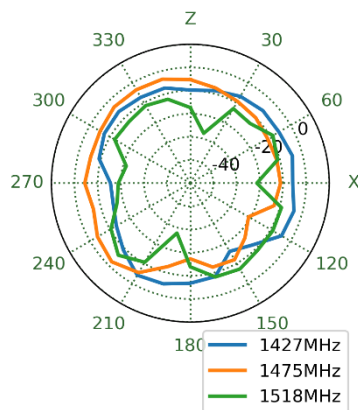

YZ Plane

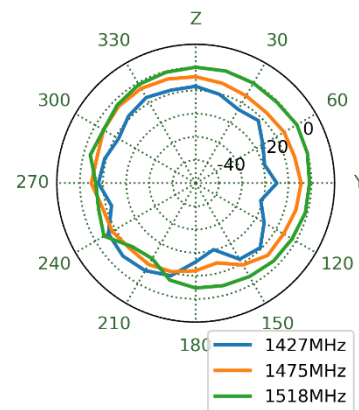

1770MHz

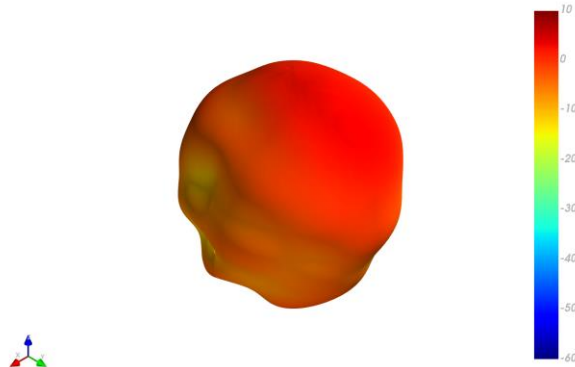

XY Plane

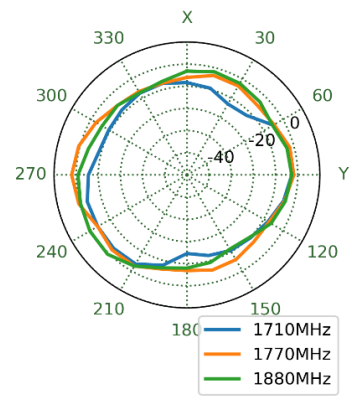

XZ Plane

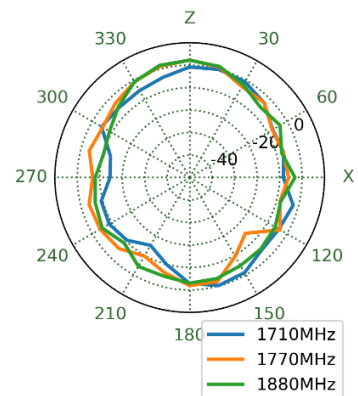

YZ Plane

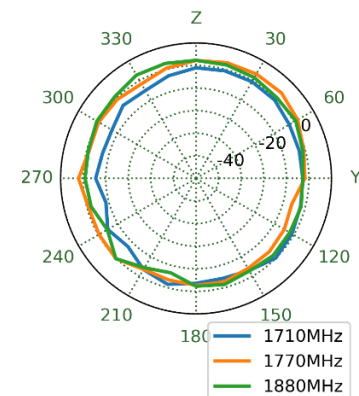

1910MHz

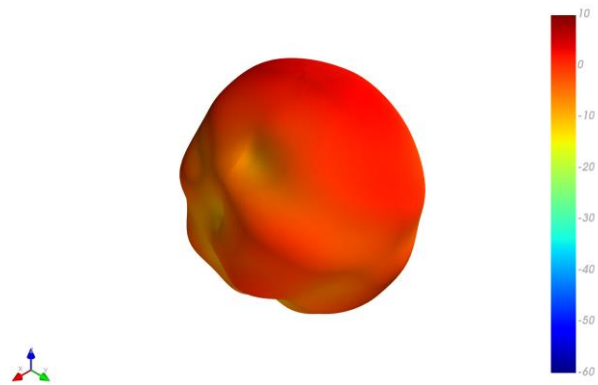

XY Plane

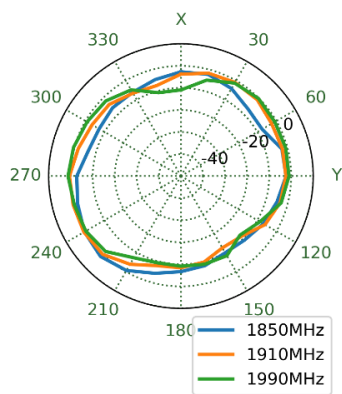

XZ Plane

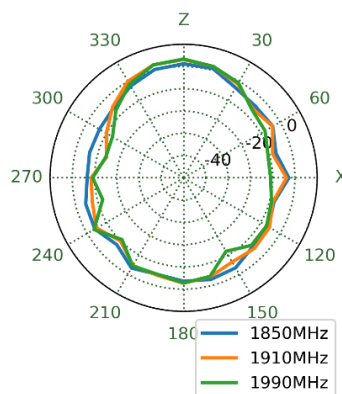

YZ Plane

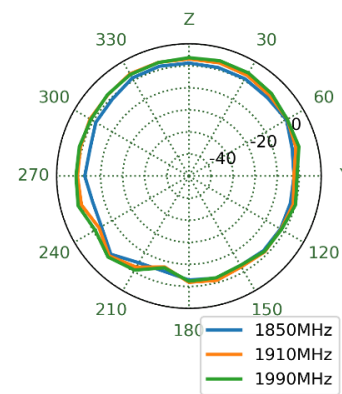

2110MHz

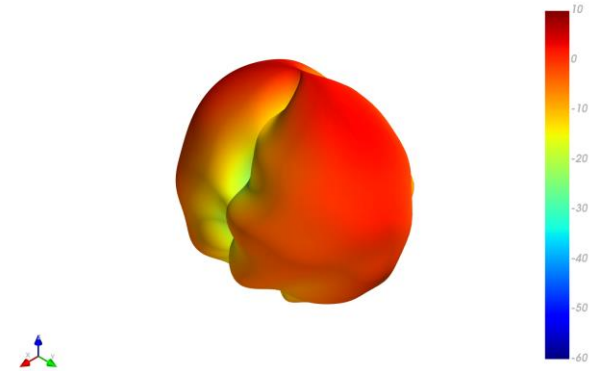

XY Plane

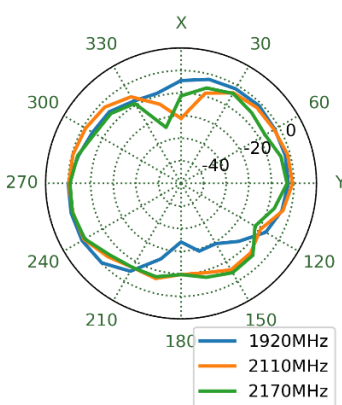

XZ Plane

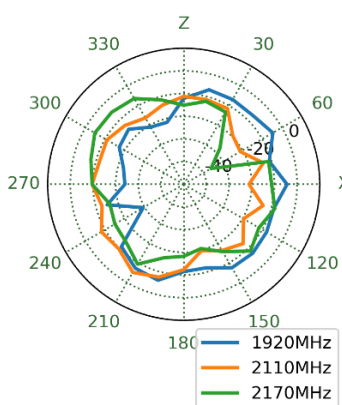

YZ Plane

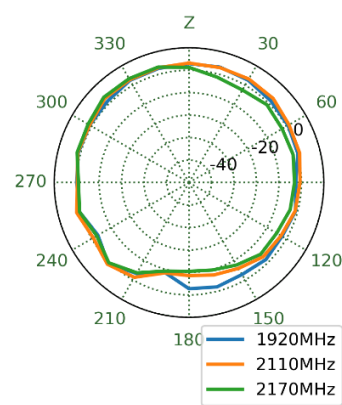

2570MHz

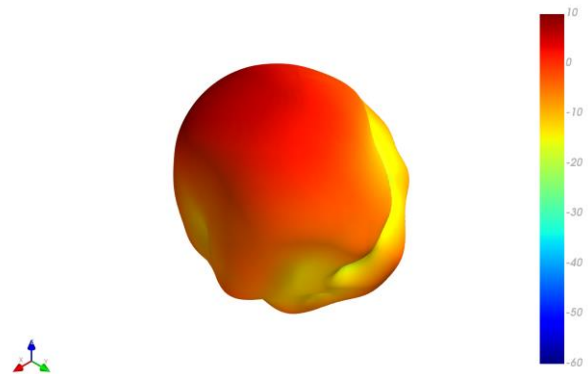

XY Plane

XZ Plane

YZ Plane

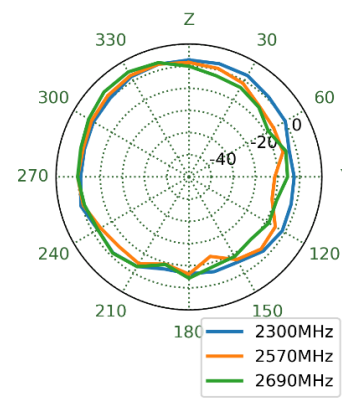
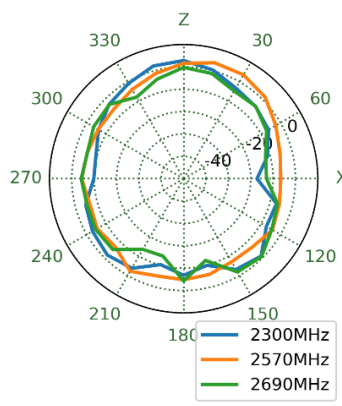
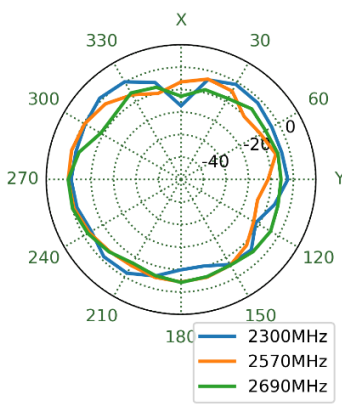

3400MHz

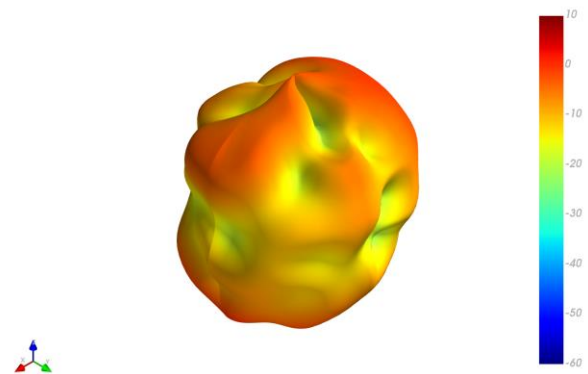

XY Plane

XZ Plane

YZ Plane

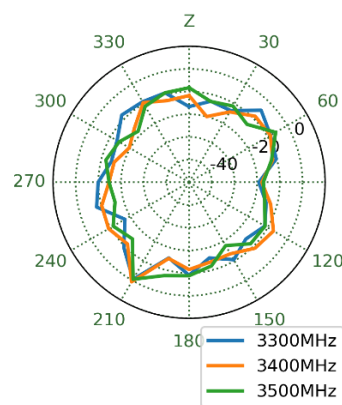
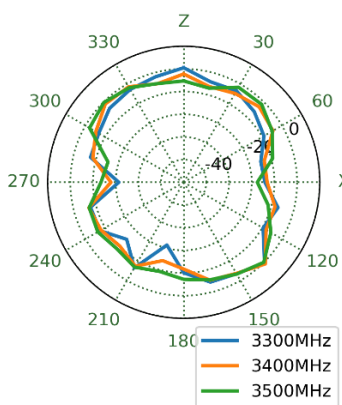
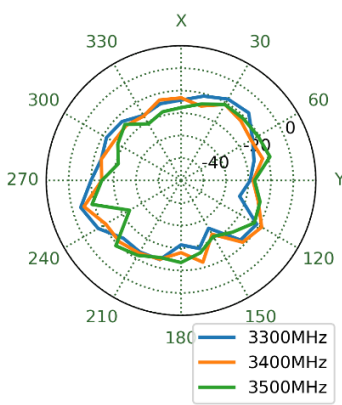

3700MHz

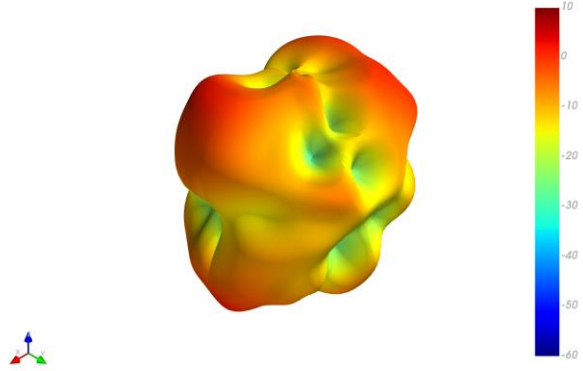

XY Plane

XZ Plane

YZ Plane

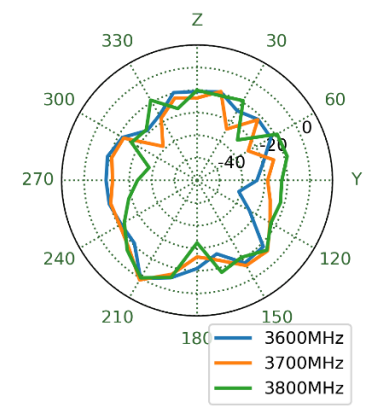
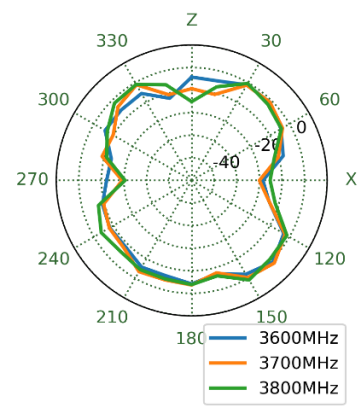
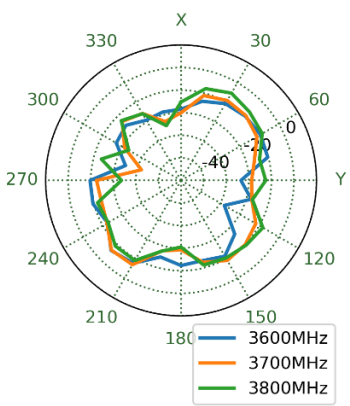

4000MHz

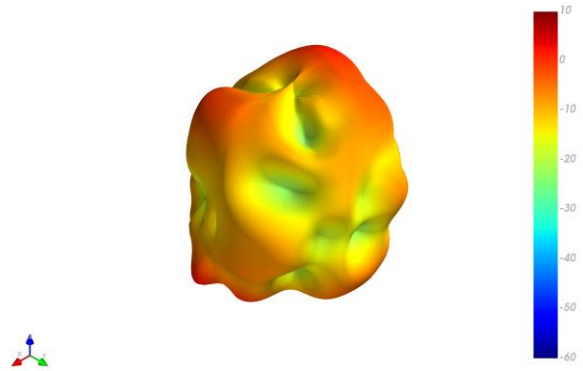

XY Plane

XZ Plane

YZ Plane

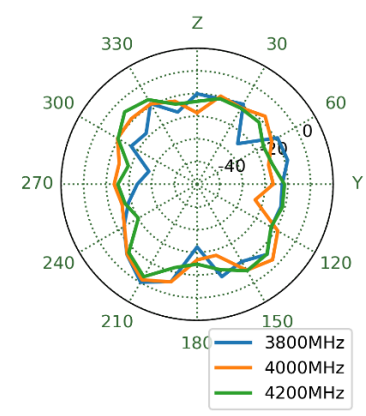
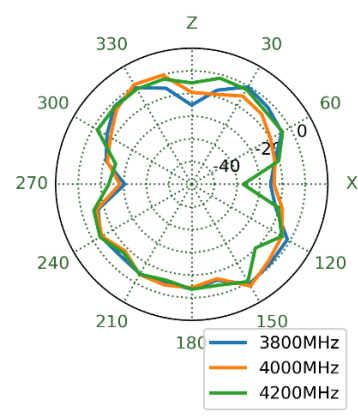
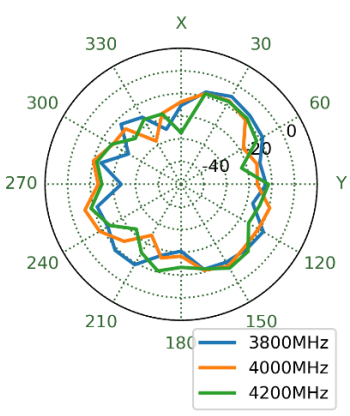

4400MHz

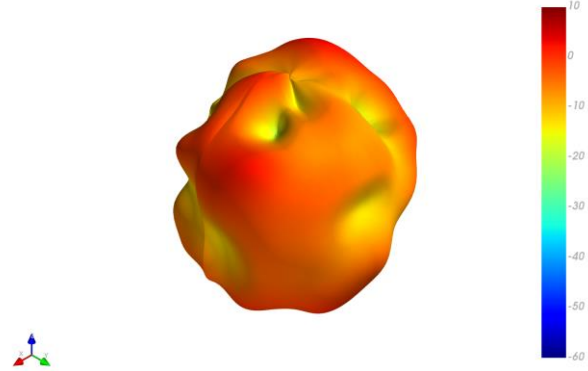

XY Plane

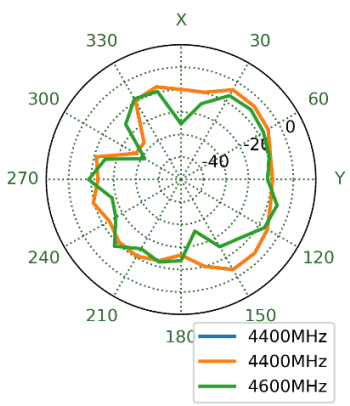

XZ Plane

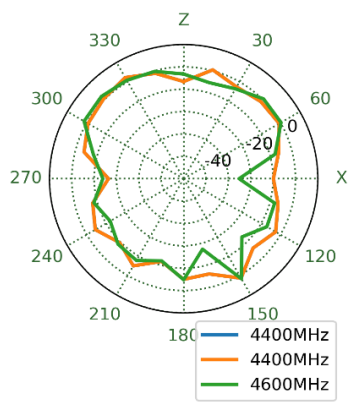

YZ Plane

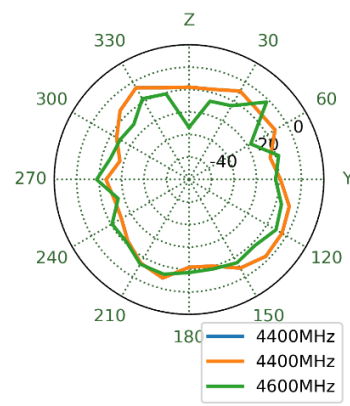

4800MHz

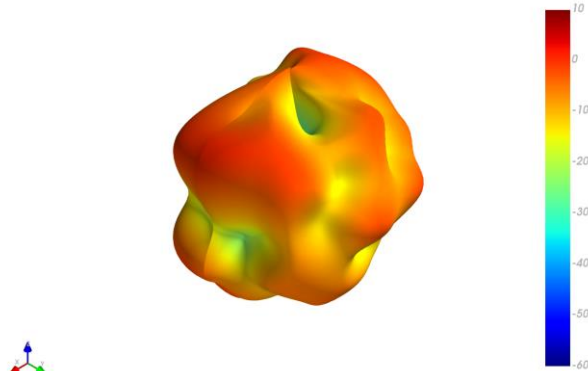

XY Plane

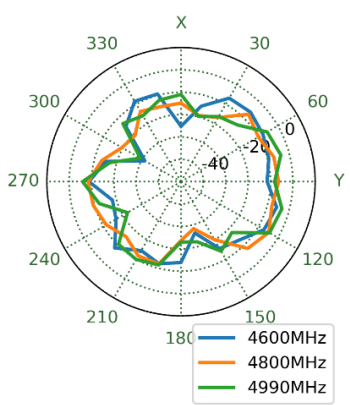

XZ Plane

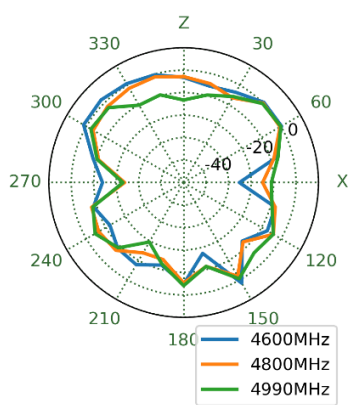

YZ Plane

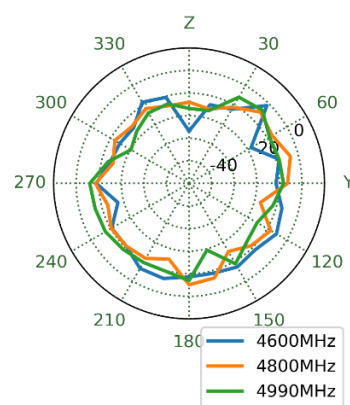

5570MHz

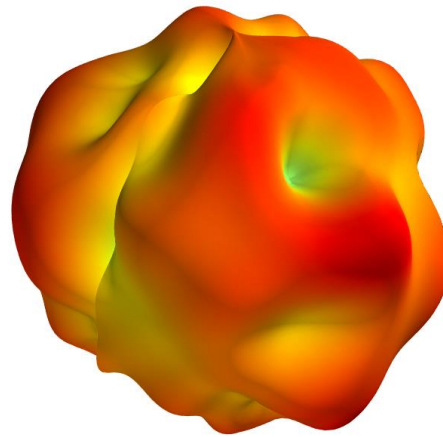

XY Plane

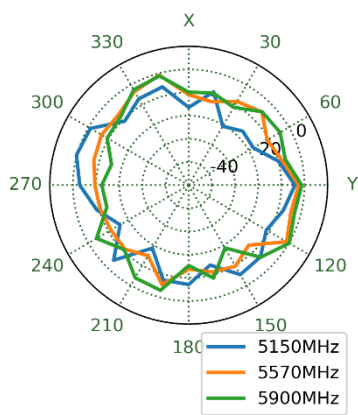

XZ Plane

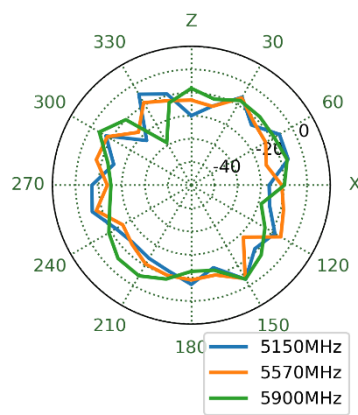

YZ Plane

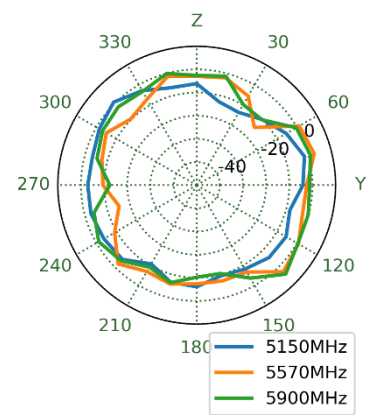

4.5 3D and 2D Radiation Patterns – MIMO 4

466MHz

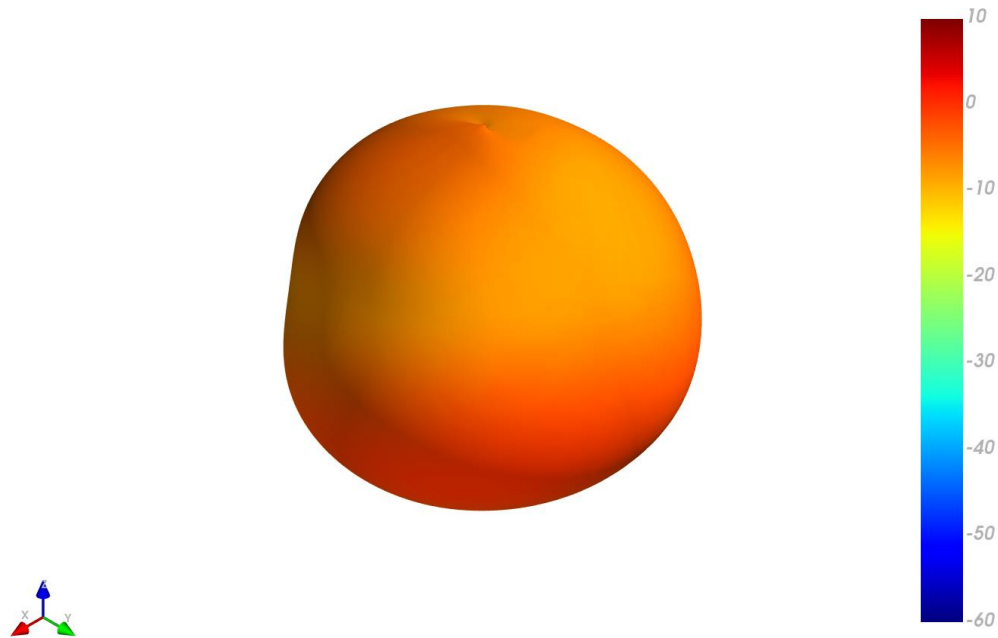

XY Plane XZ Plane YZ Plane

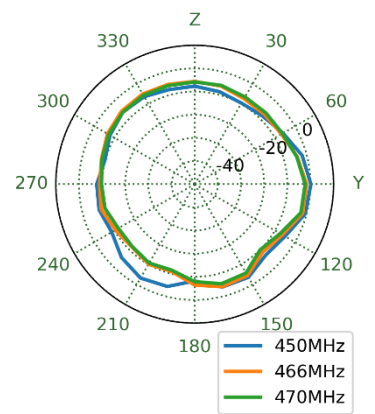
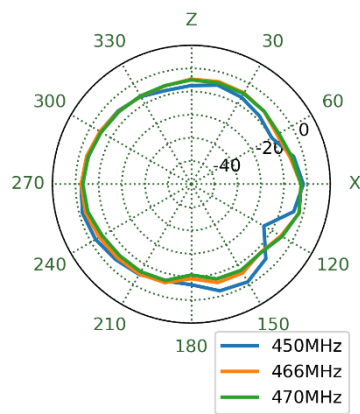
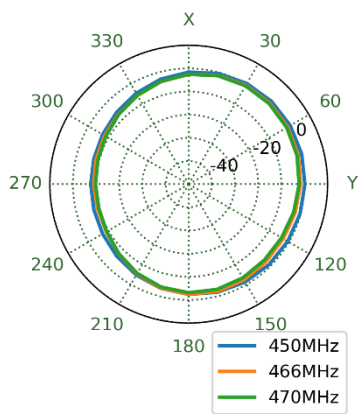

663MHz

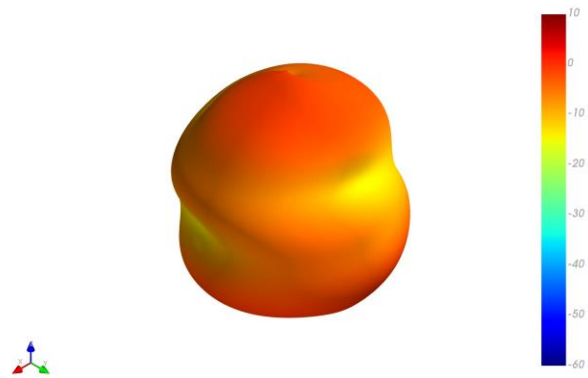

XY Plane

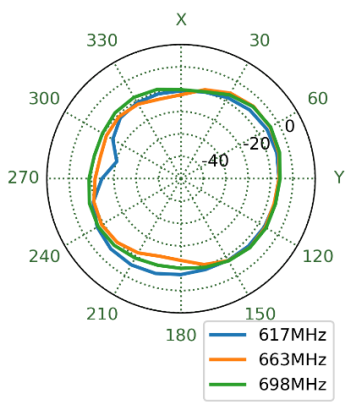

XZ Plane

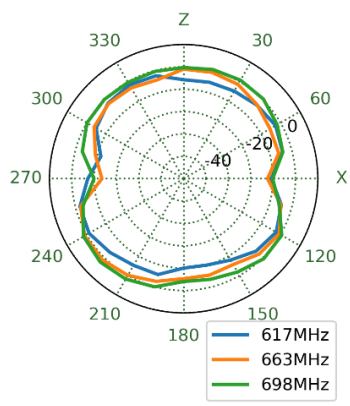

YZ Plane

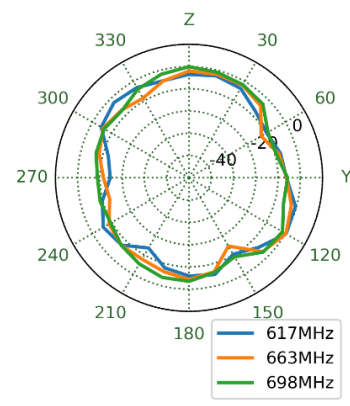

751MHz

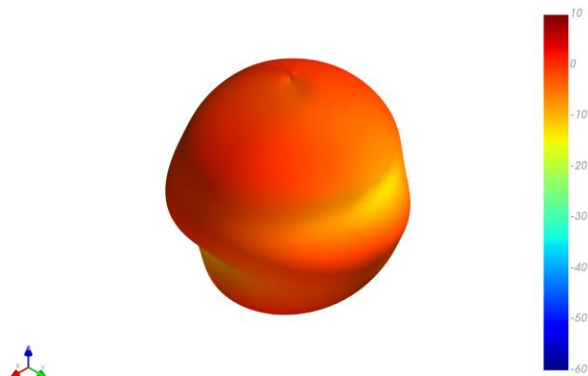

XY Plane

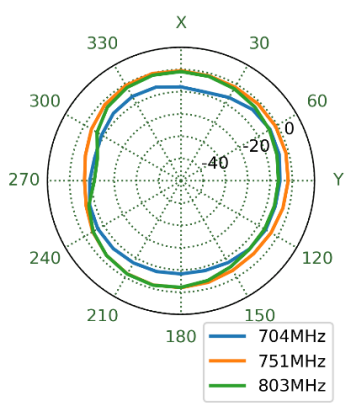

XZ Plane

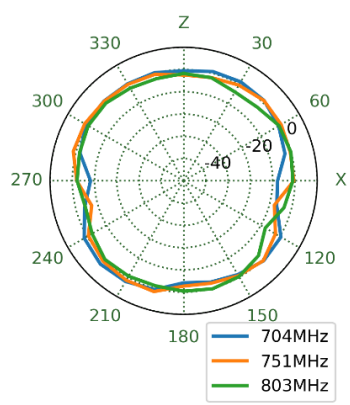

YZ Plane

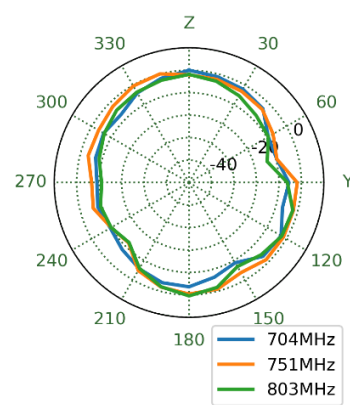

860MHz

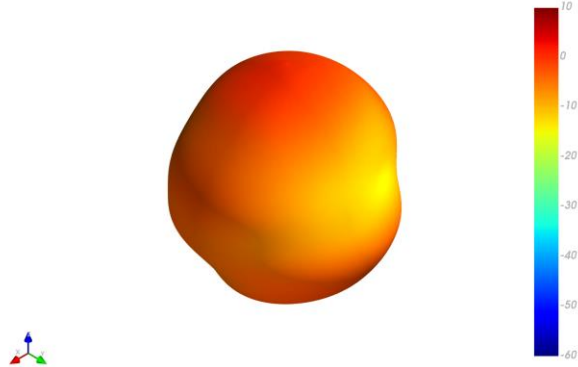

XY Plane

XZ Plane

YZ Plane

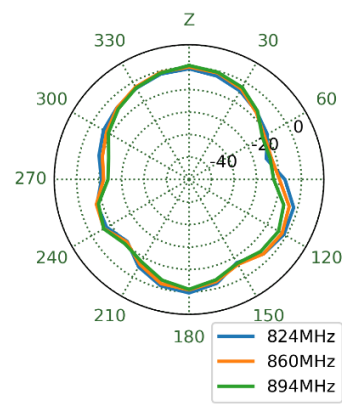
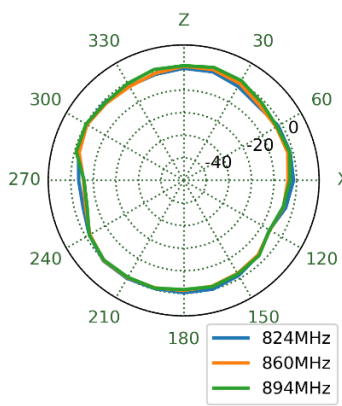
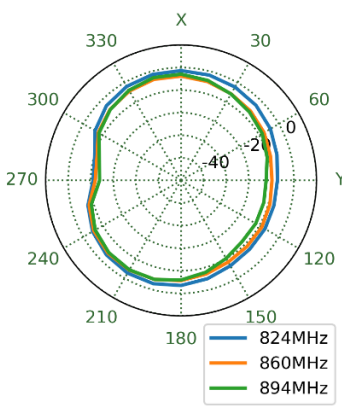

915MHz

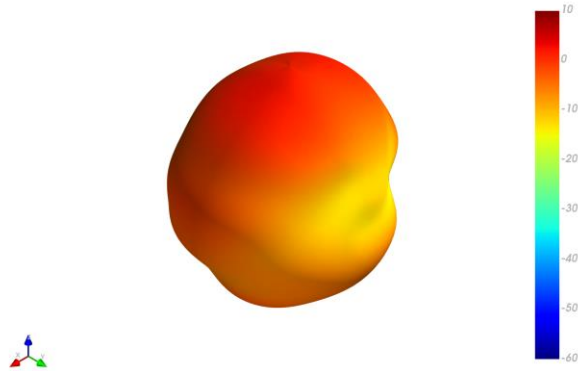

XY Plane

XZ Plane

YZ Plane

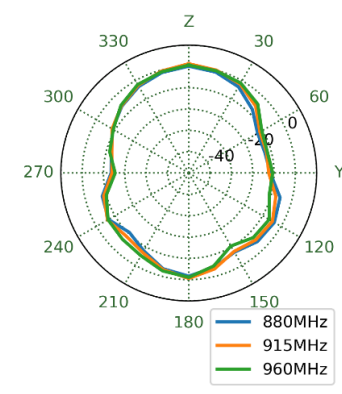
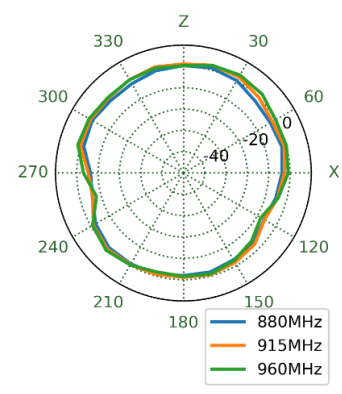
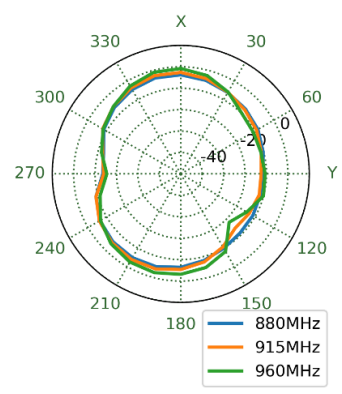

1475MHz

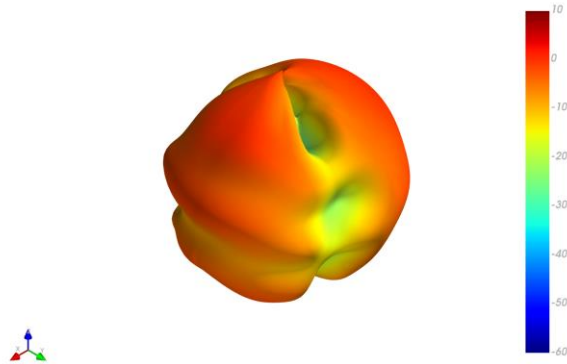

XY Plane

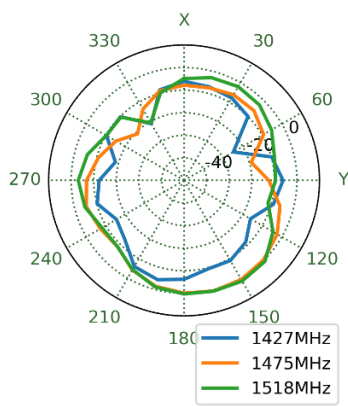

XZ Plane

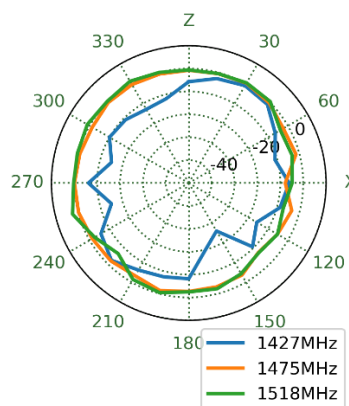

YZ Plane

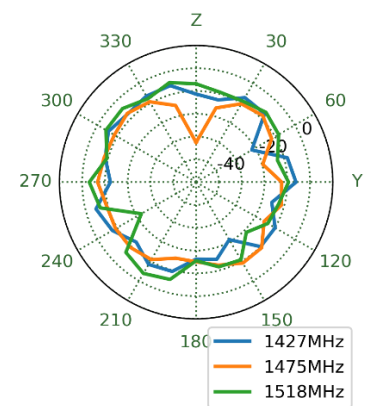

1770MHz

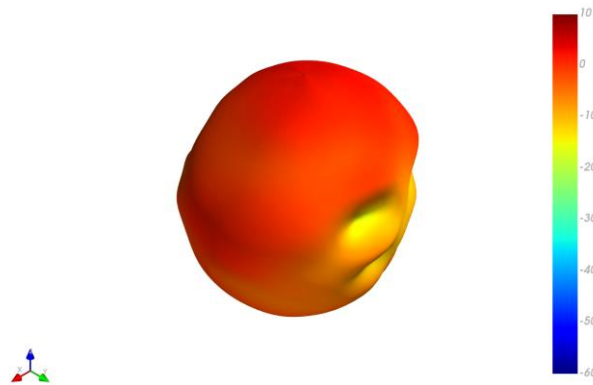

XY Plane

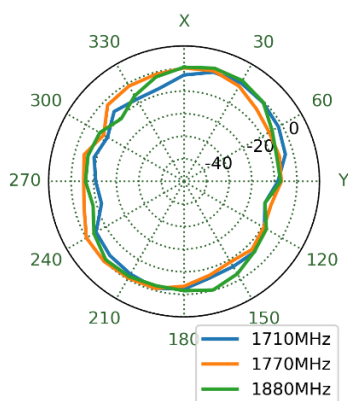

XZ Plane

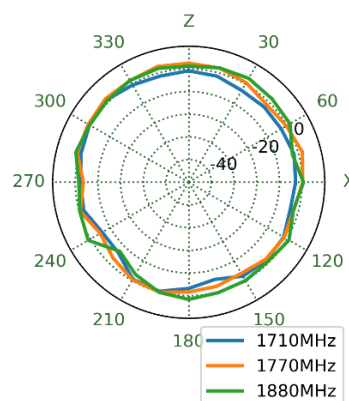

YZ Plane

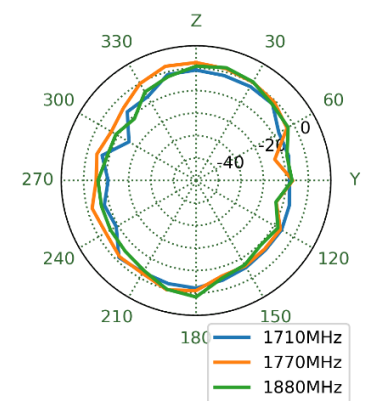

1910MHz

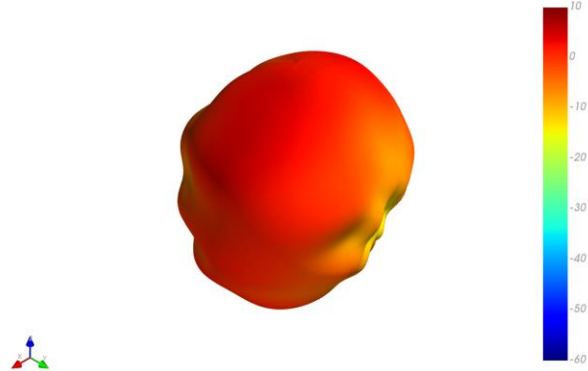

XY Plane

XZ Plane

YZ Plane

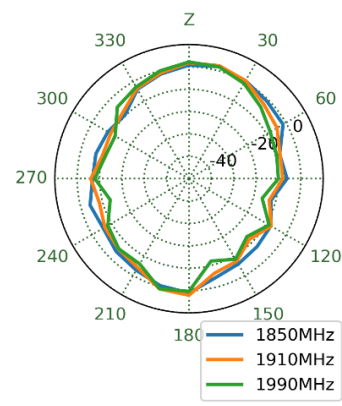
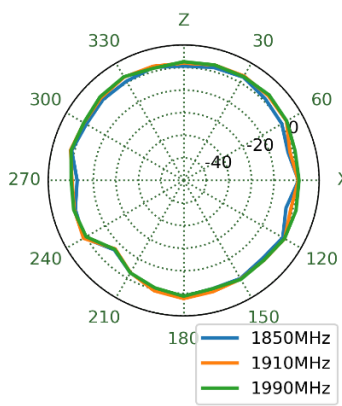
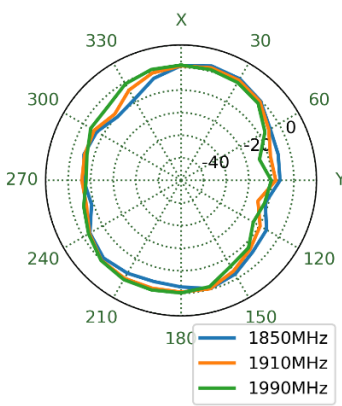

2110MHz

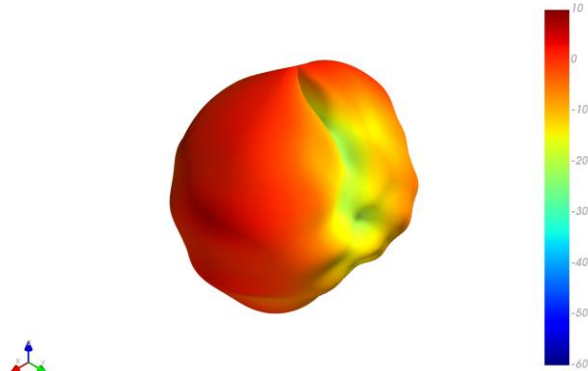

XY Plane

XZ Plane

YZ Plane

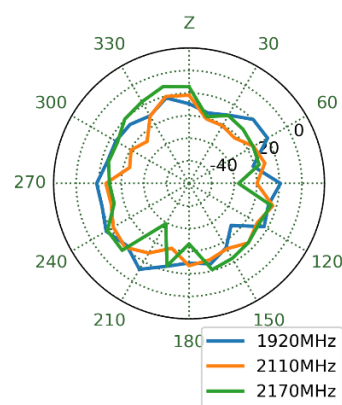
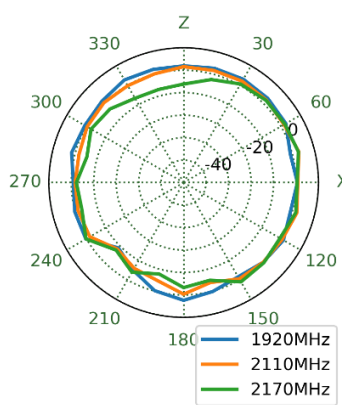
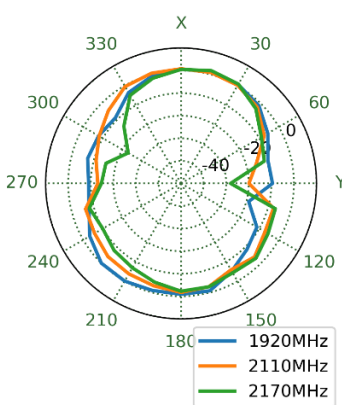

2570MHz

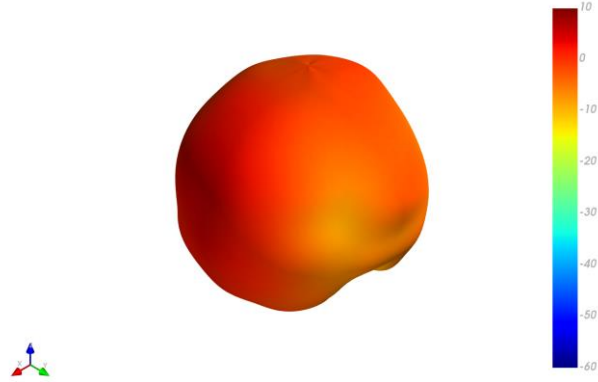

XY Plane

XZ Plane

YZ Plane

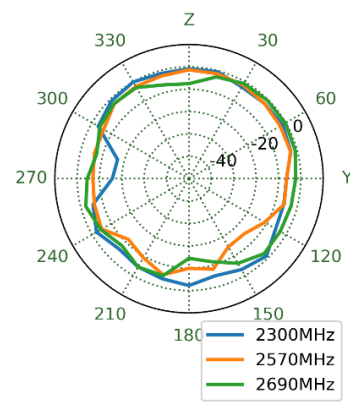
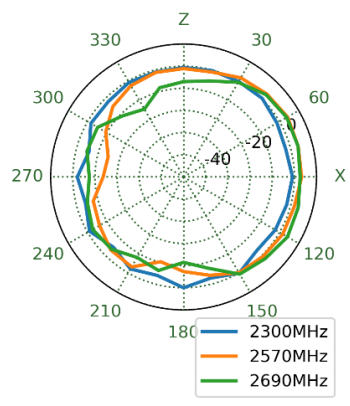
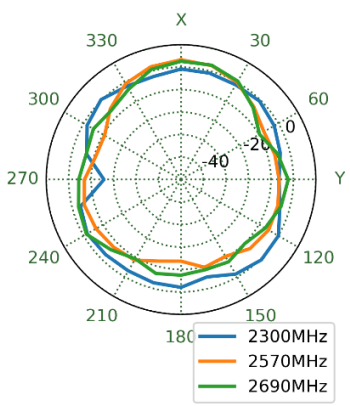

3400MHz

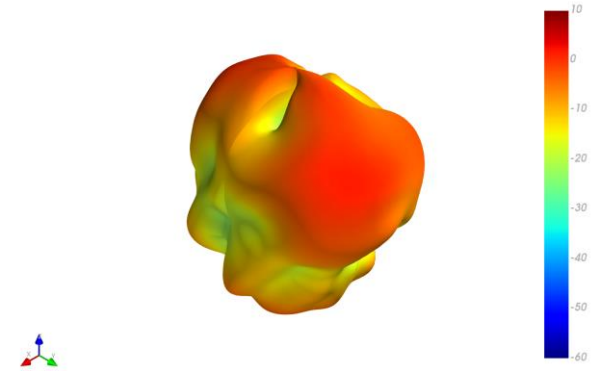

XY Plane

XZ Plane

YZ Plane

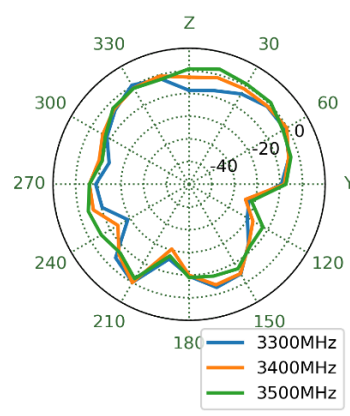
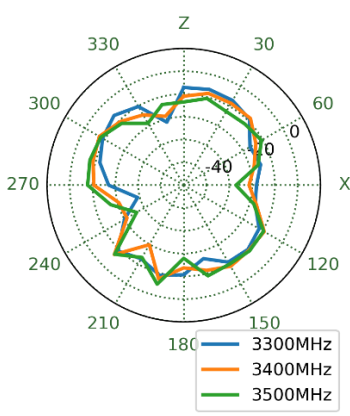
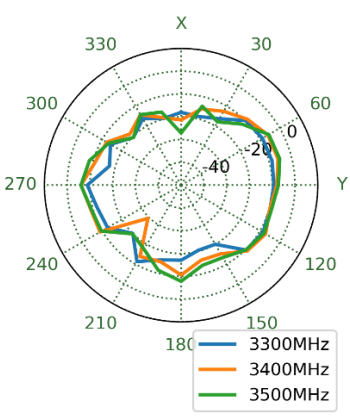

3700MHz

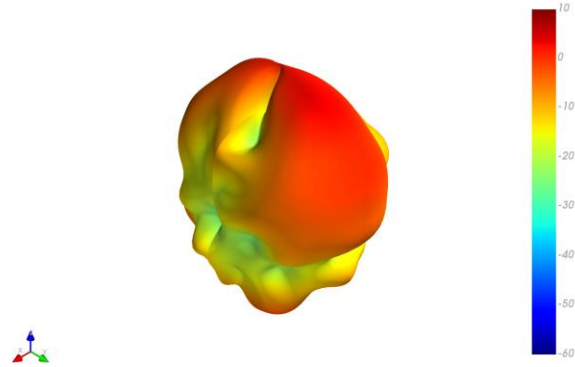

XY Plane

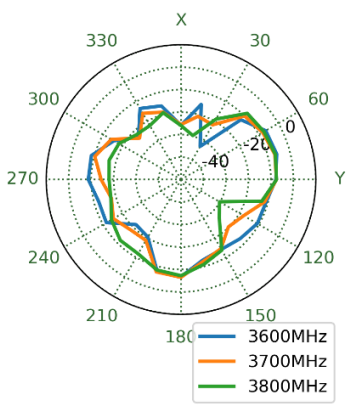

XZ Plane

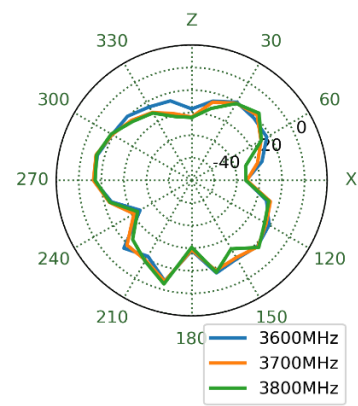

YZ Plane

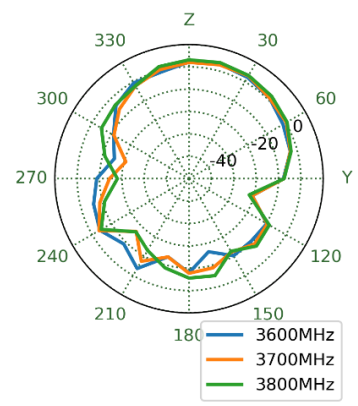

4000MHz

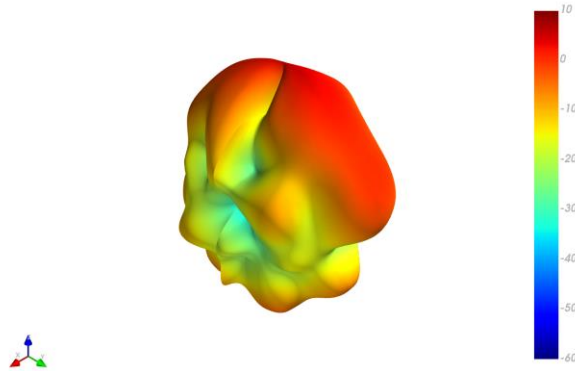

XY Plane

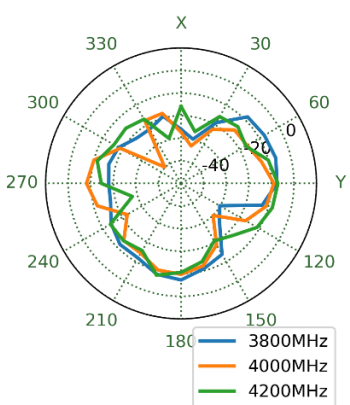

XZ Plane

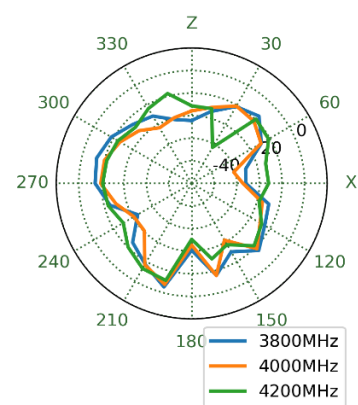

YZ Plane

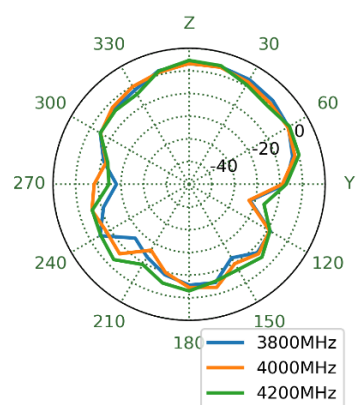

4400MHz

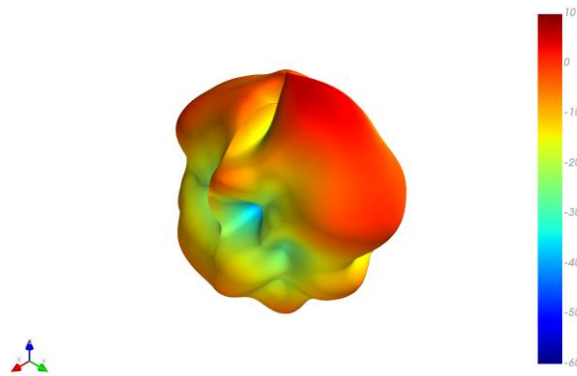

XY Plane

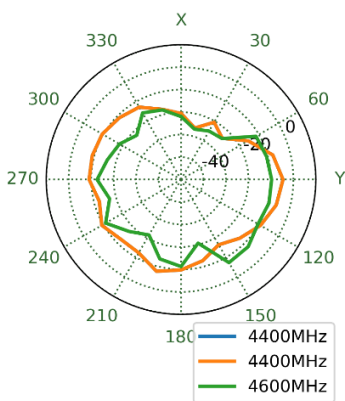

XZ Plane

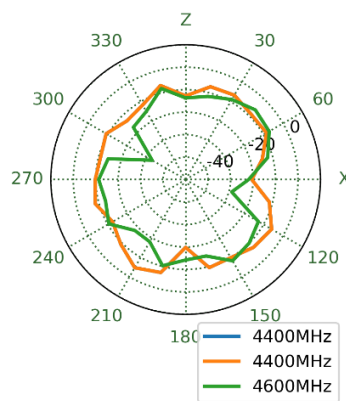

YZ Plane

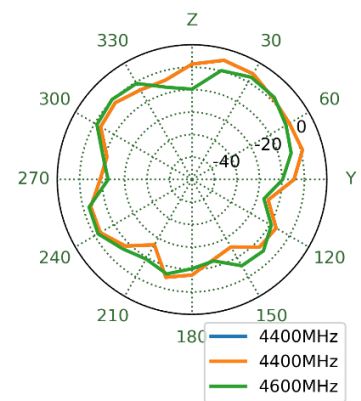

4800MHz

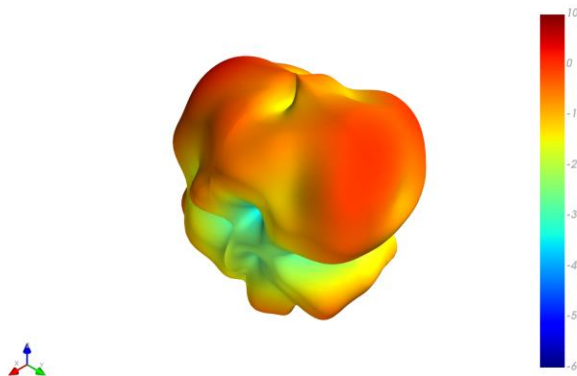

XY Plane

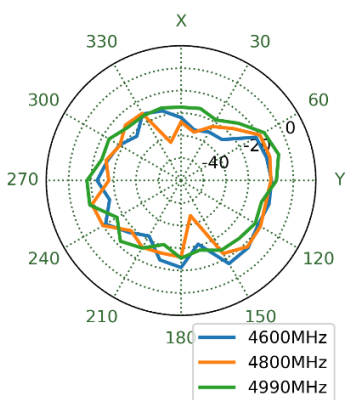

XZ Plane

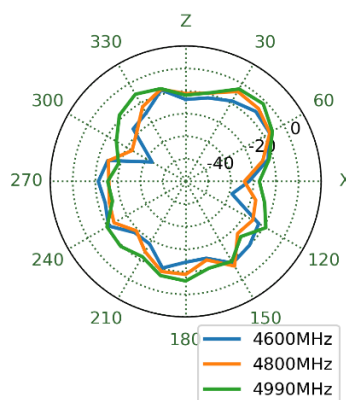

YZ Plane

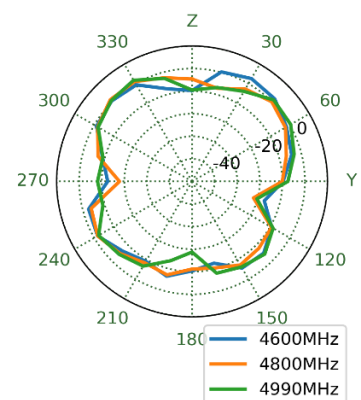

5570MHz

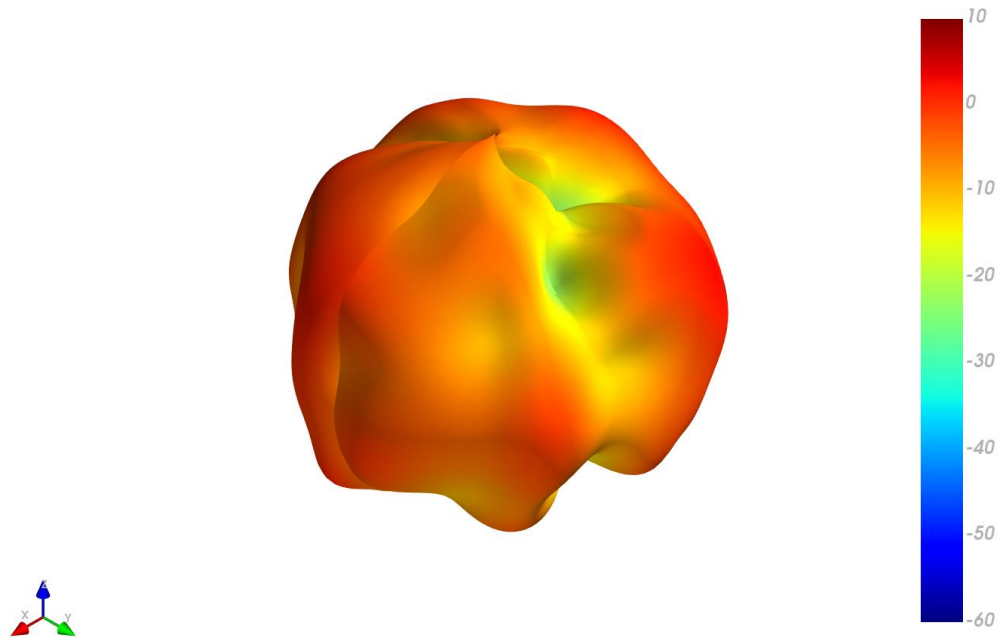

XY Plane

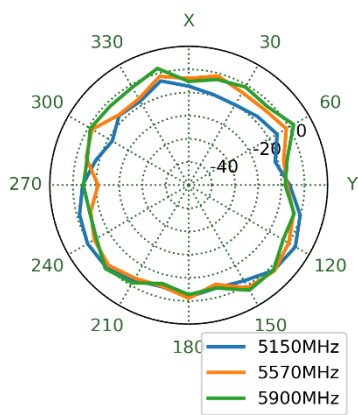

XZ Plane

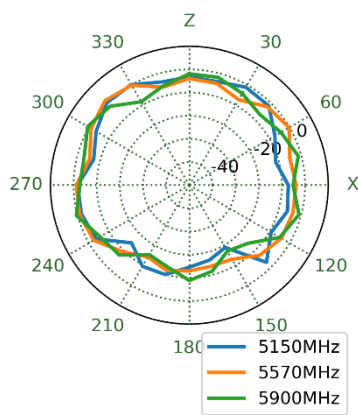

YZ Plane

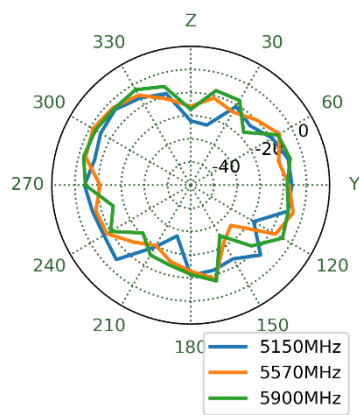

6. Installation Guidelines

Installation Instructions



TGX.04 Series

MIMO 5G/4G Antenna

Introduction

Following these guidelines will help ensure that your Taoglas TGX.04 antenna is installed correctly. The TGX.04 can be mounted via in 3 different variations; wall mount, pole mount and suction cup mount. All mounting methods are outlined below.



Installation Requirements

Antenna Components: Mounting Plate (x1), Tightening Nut (x1), Antenna Housing (x1), Coaxial Cable(x4)

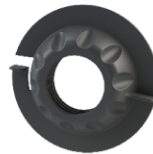

- Pole Mount:
 - 7mm [9/32"] socket wrench or screwdriver, metal mounting clamp (x2)
 - Pole Diameter Range: 22mm [0.9"] - 50mm [2"]
 - Metal Mounting Clamp
- Wall Mount:
 - Screwdriver, drill, M4 [Gauge 8] screw (x4), M4 [Gauge 8] washer (x4), 6mm [1/4"] wall mount stud (x4)
- Suction Cup Mount:
 - D40 Suction cups (x4)

Notices



Caution

To comply with FCC RF Exposure requirements in section 1.1310 of the FCC Rules, antennas used with this device must be installed to provide a separation distance of at least 20 cm from all persons to satisfy RF exposure compliance.



Warning

Do not Operate the transmitter when someone is within 20 cm of the antenna.
Do not operate the equipment in an explosive atmosphere.



European Waste Electronic Equipment Directive 2002/96/EC

Please ensure that your old Waste Electricals and Electronics are recycled do not throw them away into standard waste.

Waiver: This document represents information compiled by Taoglas to the best of our current knowledge. This is not intended to be used as a representation or warranty of fitness of the products described for any particular purpose. This document details guidelines for general information purposes only. When planning installations, always seek specialist advice and ensure that the products are always installed by a properly qualified installer in accordance with applicable regional laws and regulations.

All copyrights, trademarks and any other intellectual property rights related are owned by Taoglas Group Holdings Limited.

Hardware Installation

The TGX.45 antenna can be installed with 3 different methods: pole mount, wall mount, and suction cup mount. Please refer to the appropriate section below that best fits your installation needs

Pole Mount Installation



Insert the metal mounting clamps(both top and bottom) through the inner slots of the mounting plate



Loop the mouting straps around the pole at the desired position and tighten the strap until the mounting plate is fixed. Use the self centering feature to guide the mounting plate onto the pole

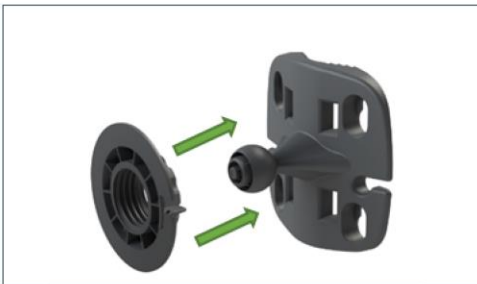

Insert the tightening nut onto the ball joint mount with the flat surface facing away from the mounting plate



Insert the ball joint firmly into the socket on the back of the antenna body and slide the tightening nut into the antenna housing's back plate to secure in place. Adjust to the desired antenna orientation on the bal joint and tighten the nut to fix the antenna in place.

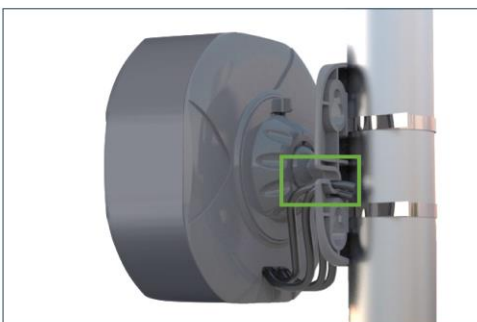

Optional: Route cables through the cable guide on the mounting plate



Completed Installation

Hardware Installation

The TGX.45 antenna can be installed with 3 different methods: pole mount, wall mount, and suction cup mount. Please refer to the appropriate section below that best fits your installation needs

Wall Mount Installation



Correct Screw and Washer Location

Using the mounting plate as a guide mark the position of the screws to the desired location. Drill holes for wall mount studs (6mm [1/4"] diameter, min 25mm [1"] depth) and secure the studs in place. Position the washers into the mounting plate, insert the screws through and into the wall studs. Drive the screws in and tighten to secure the mounting plate in place



Insert the tightening nut onto the ball joint mount from the mounting plate



Insert the ball joint firmly into the socket on the back of the antenna body and slide the tightening nut into the antenna housing's back plate to secure in place. Adjust to the desired antenna orientation on the ball joint and tighten the nut to fix the antenna in place



Completed Installation

Hardware Installation

The TGX.45 antenna can be installed with 3 different methods: pole mount, wall mount, and suction cup mount. Please refer to the appropriate section below that best fits your installation needs

Suction Cup Mount Installation



Insert the metal mounting clamps(both top and bottom) through the inner slots of the mounting plate



Using the mounting plate as guide on the mounting surface, align to the desired location of the antenna. Press firmly on each cup to secure in place
 Note: Check that the surface to mount on is flat, non-porous, and has been adequately cleaned to ensure proper adhesion.

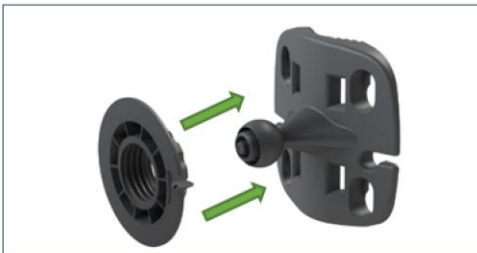

Insert the tightening nut onto the ball joint mount with the flat surface facing away from the mounting plate



Insert the ball joint firmly into the socket on the back of the antenna body and slide the tightening nut into the antenna housing's back plate to secure in place. Adjust to the desired antenna orientation on the ball joint and tighten the nut to fix the antenna in place.



Completed Installation

7. Packaging

Kit:
 1pc TGX.04.A.001
 4pcs Suction Cup
 4pcs Wall plug + screw
 4pcs Plastic Washer
 2pcs Metal Cable Ties
 1 Kit per Small Box
 Dimensions: 180*177*236mm
 Weight: 900g

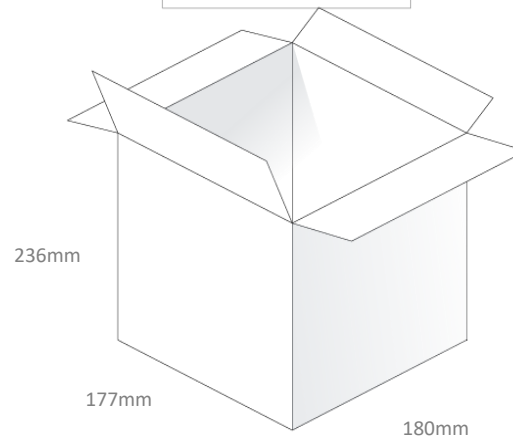

8pcs TGX.04.A.001 per Carton
 Carton Dimensions: 746*375*260mm
 Weight: 8Kg

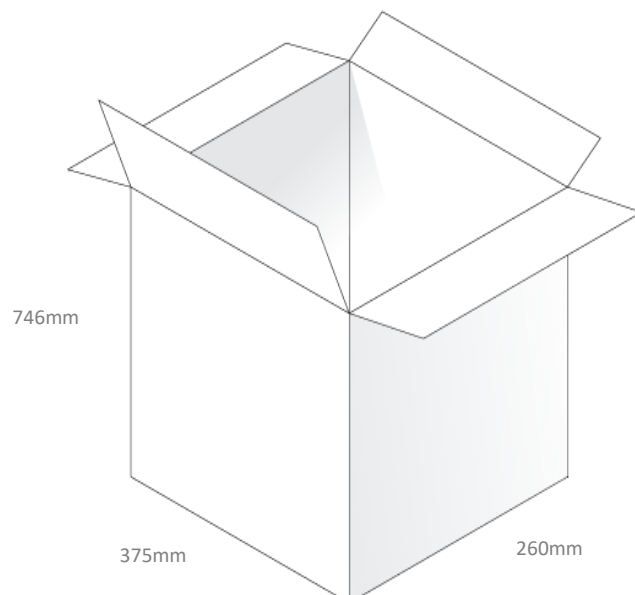

8. Application Note

The TGX.04's performance varies based on cable length due to loss values, as demonstrated in the following section.

8.1 Efficiency

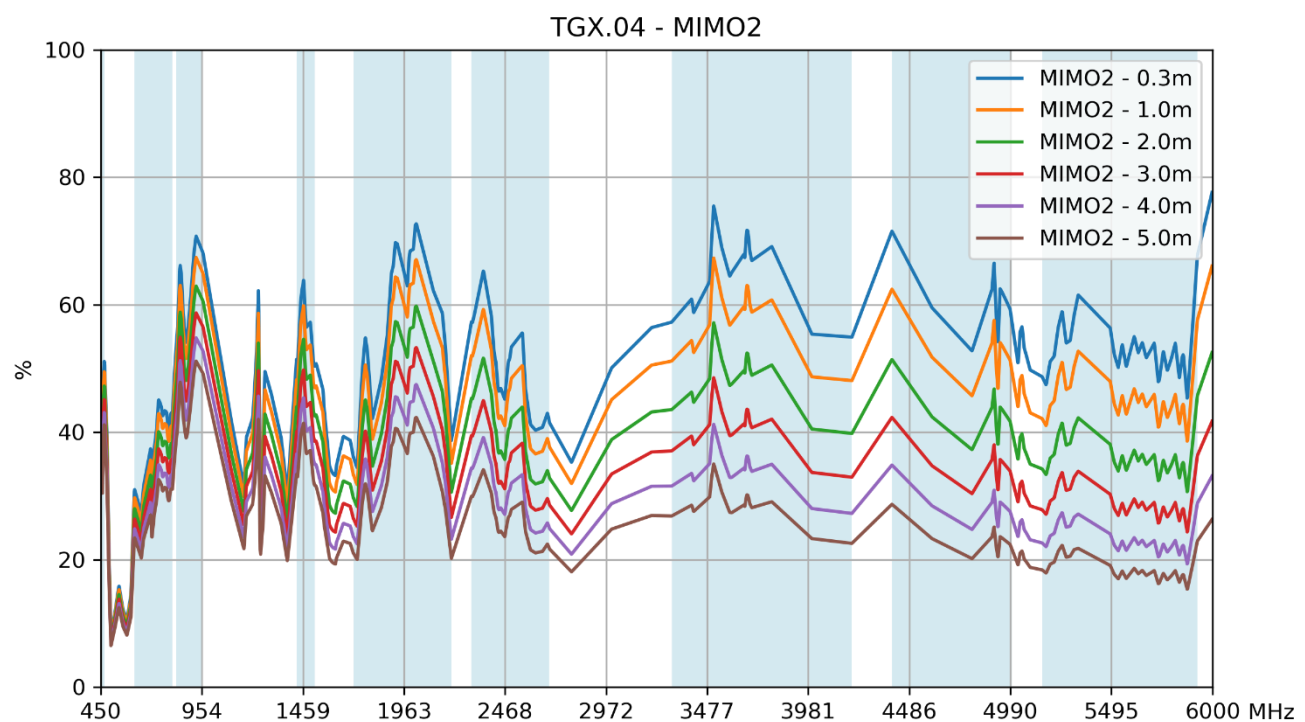
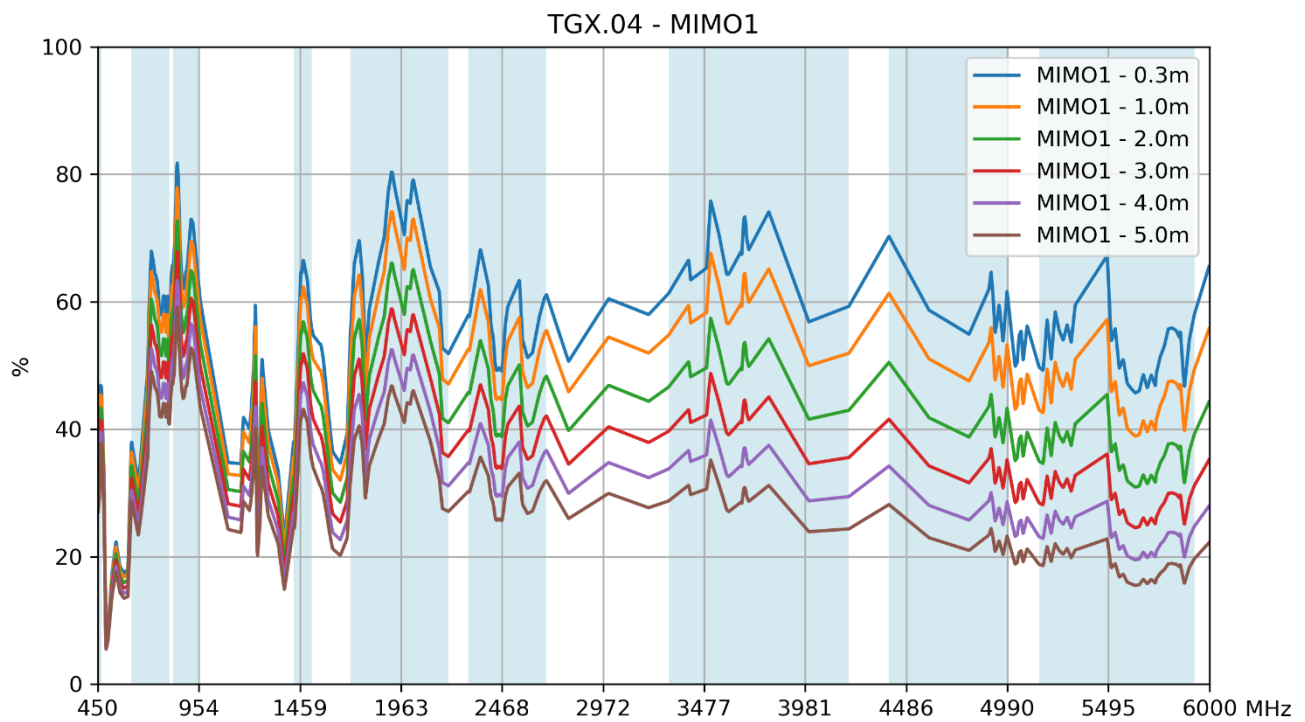

TGX.04 - MIMO3

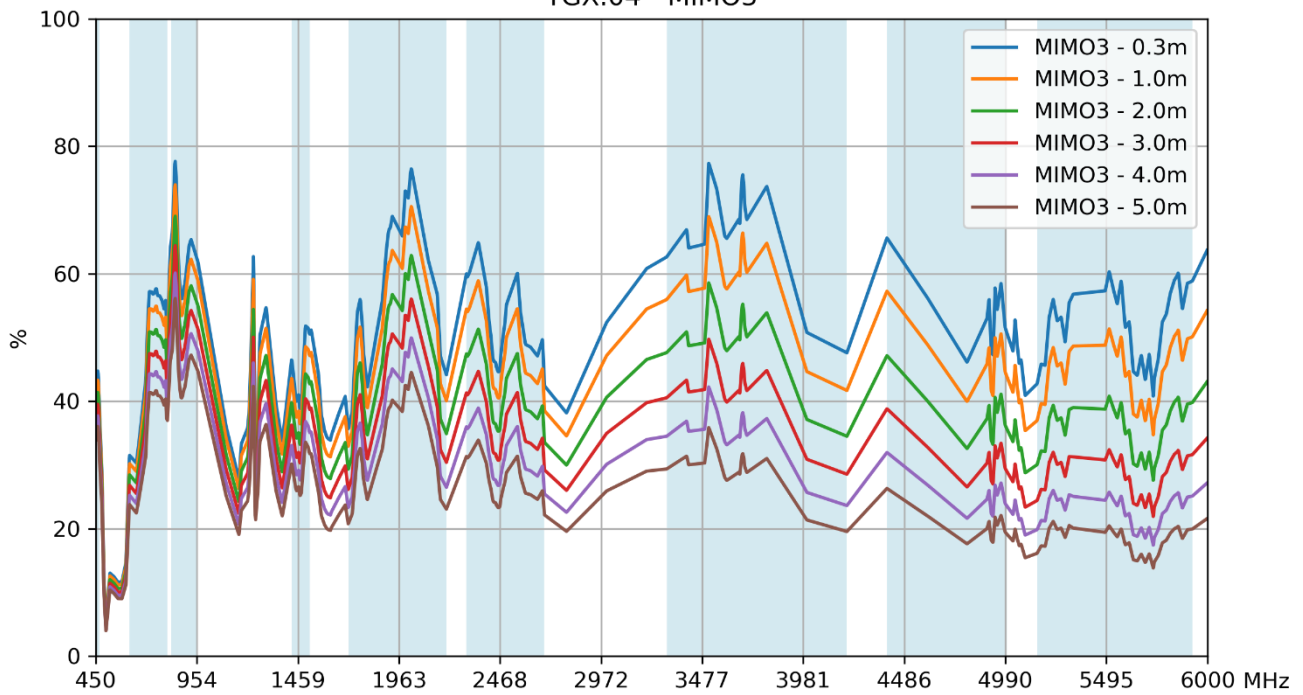

TGX.04 - MIMO4

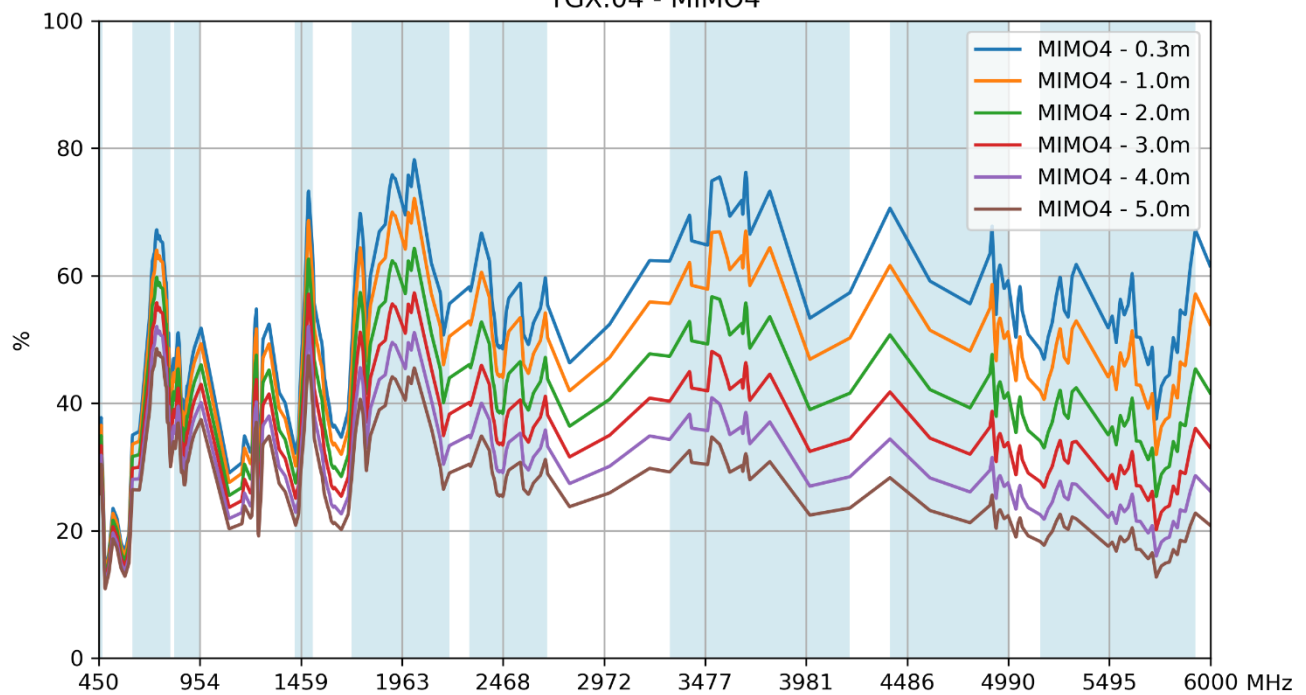

8.2 Peak Gain

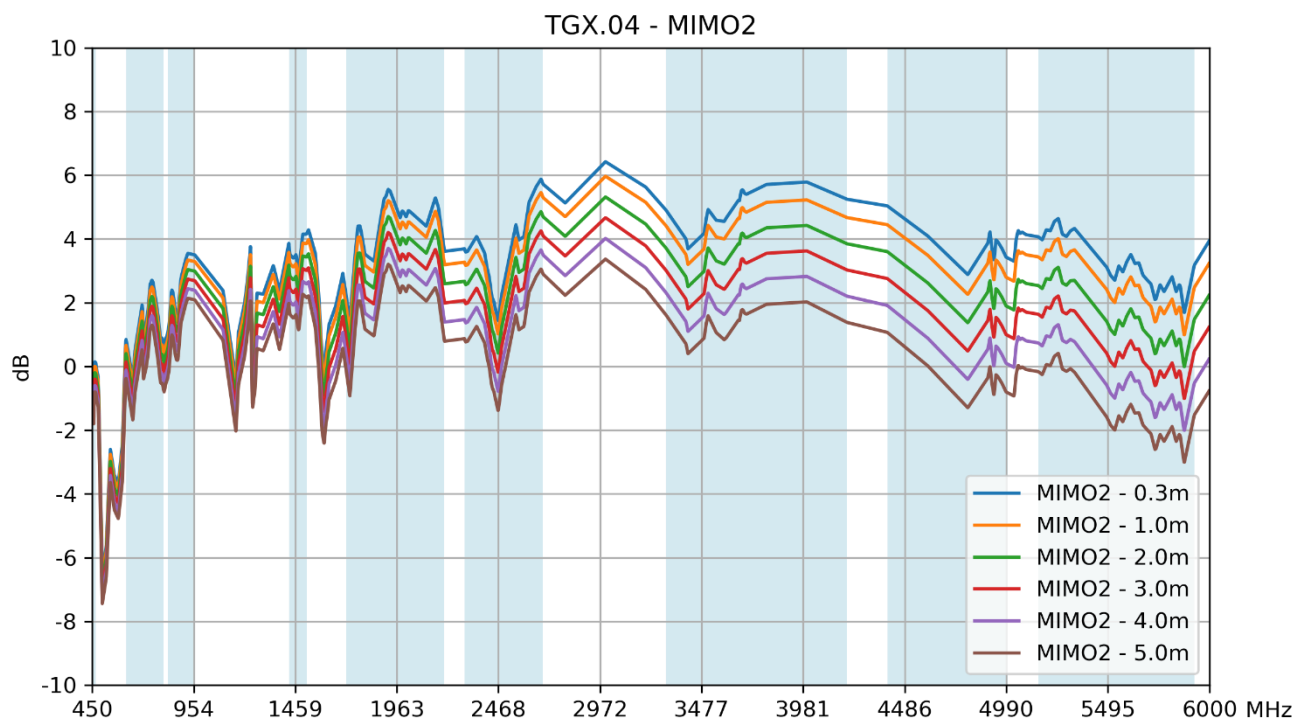
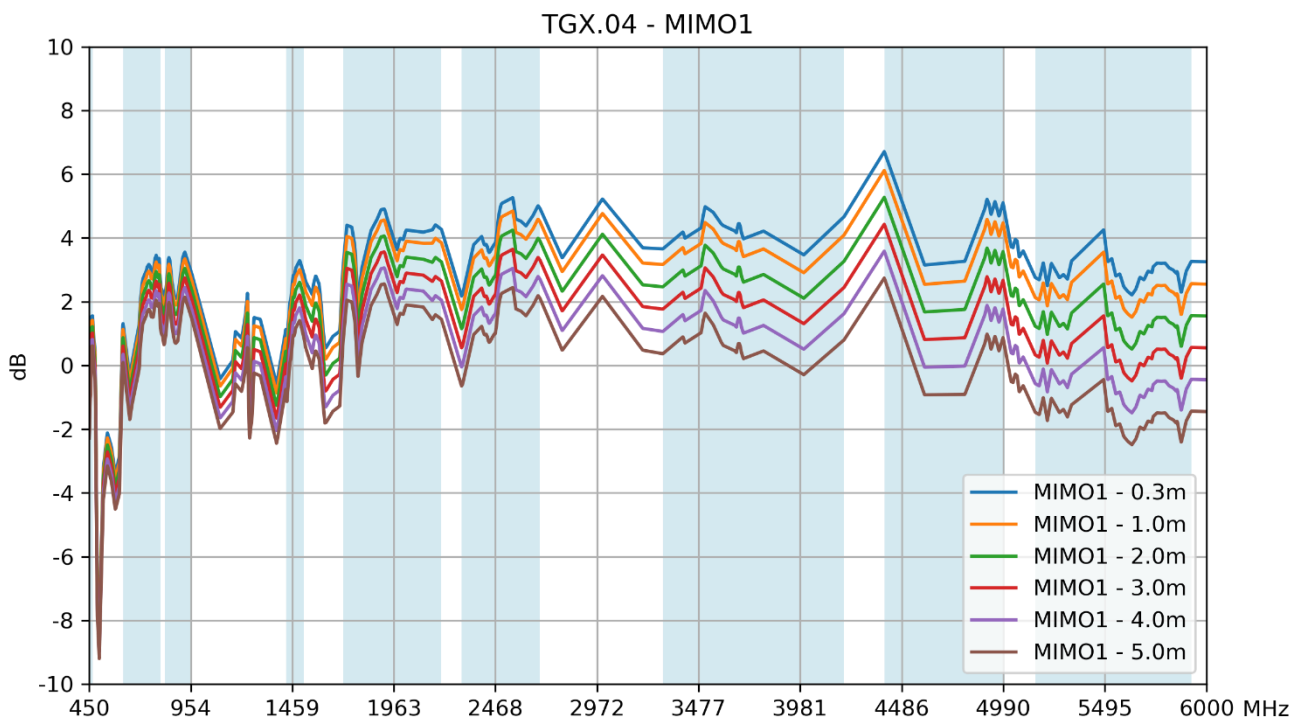

TGX.04 - MIMO3

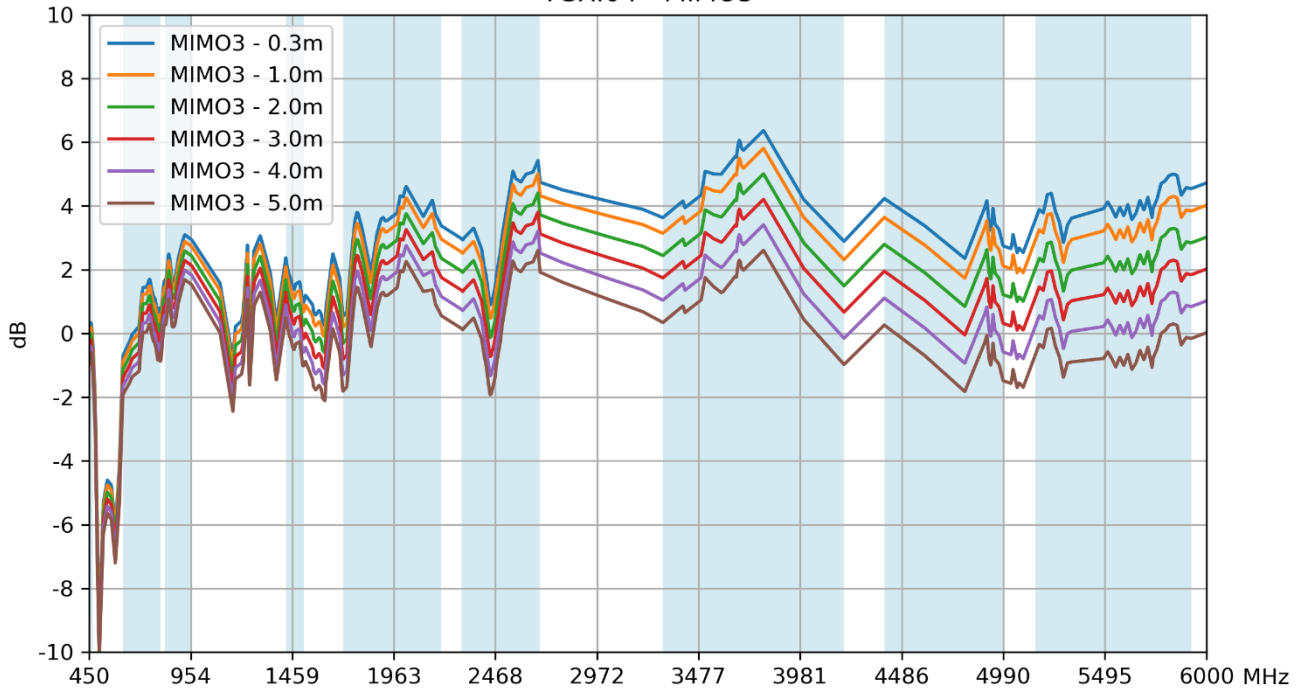

TGX.04 - MIMO4

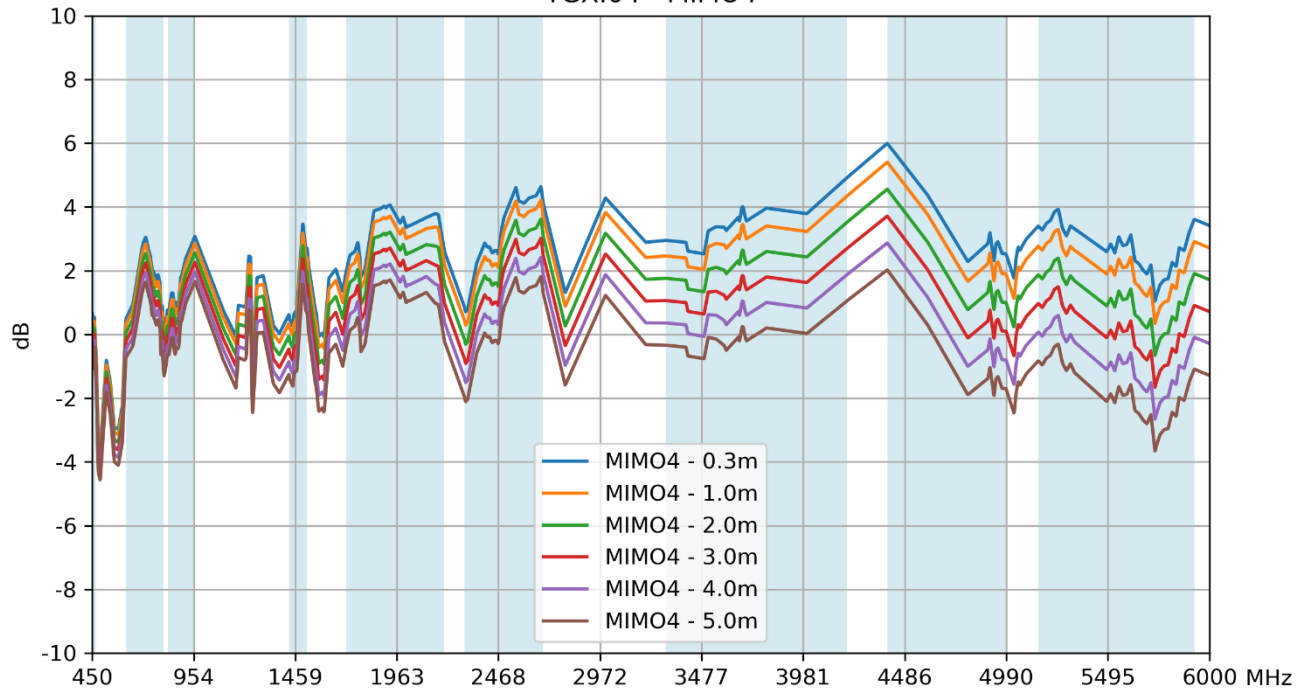

8.3 Average Gain

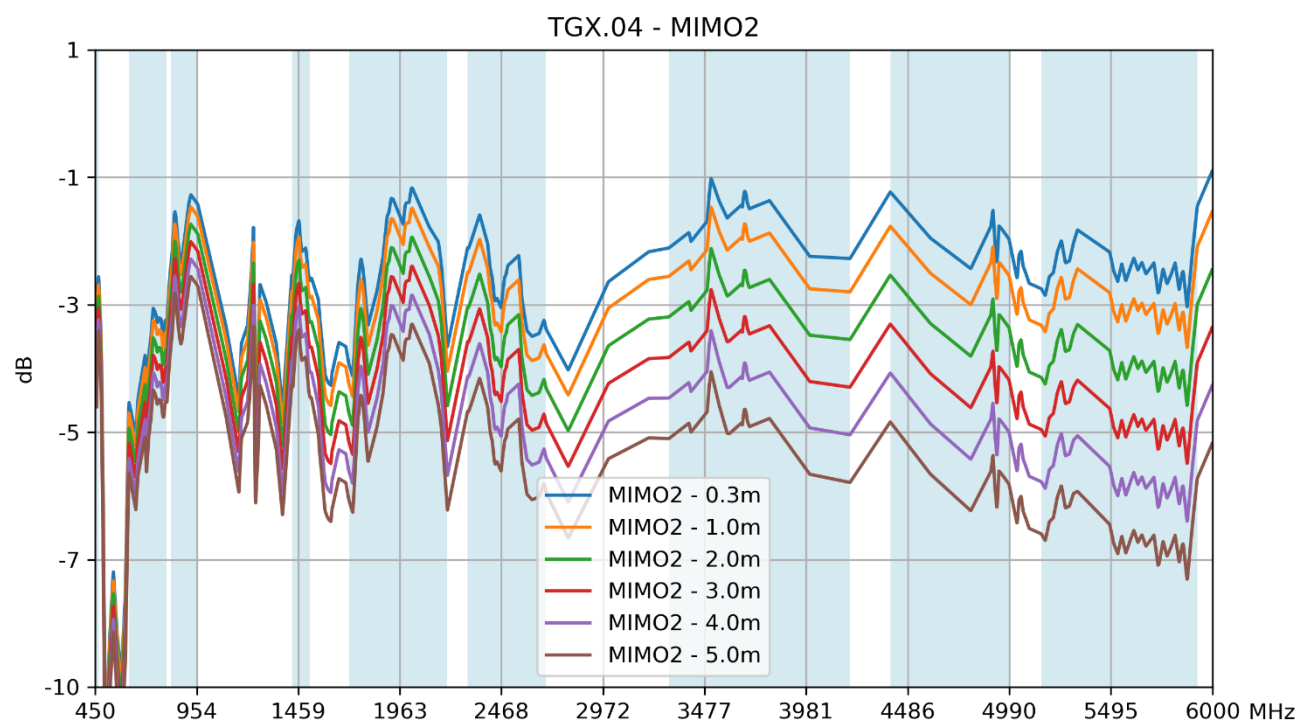
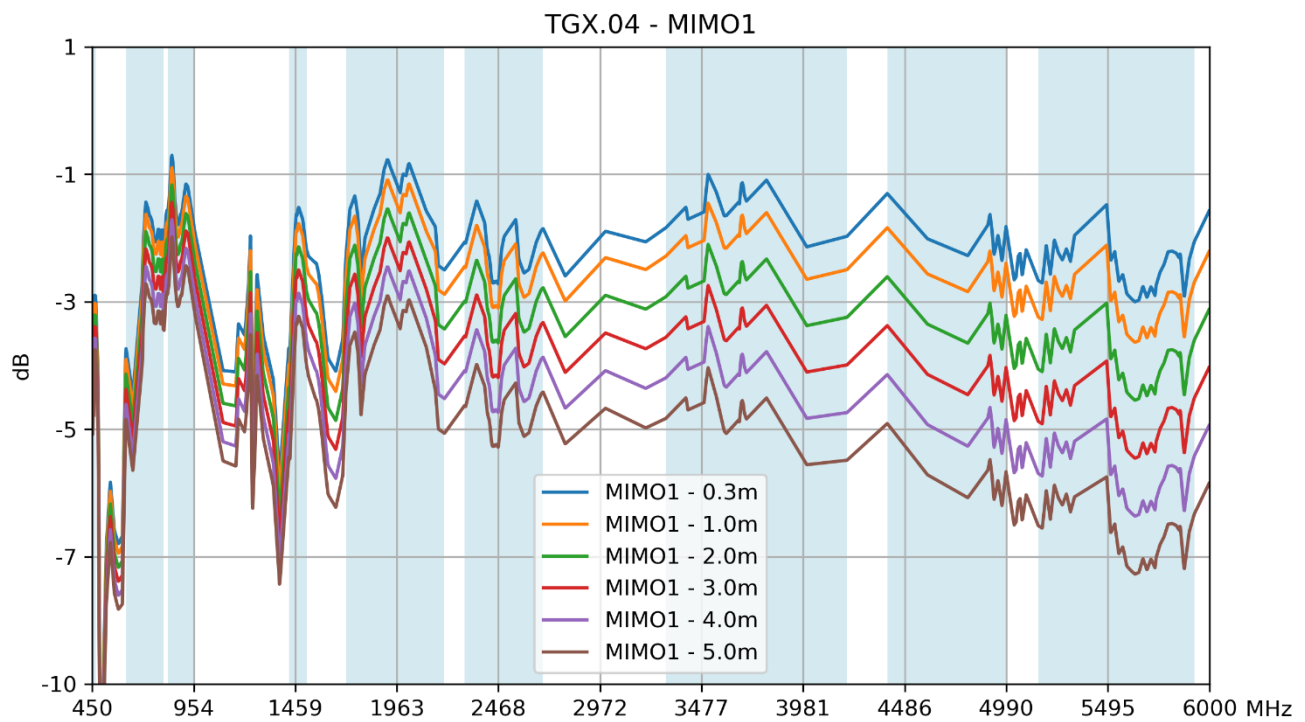

TGX.04 - MIMO3

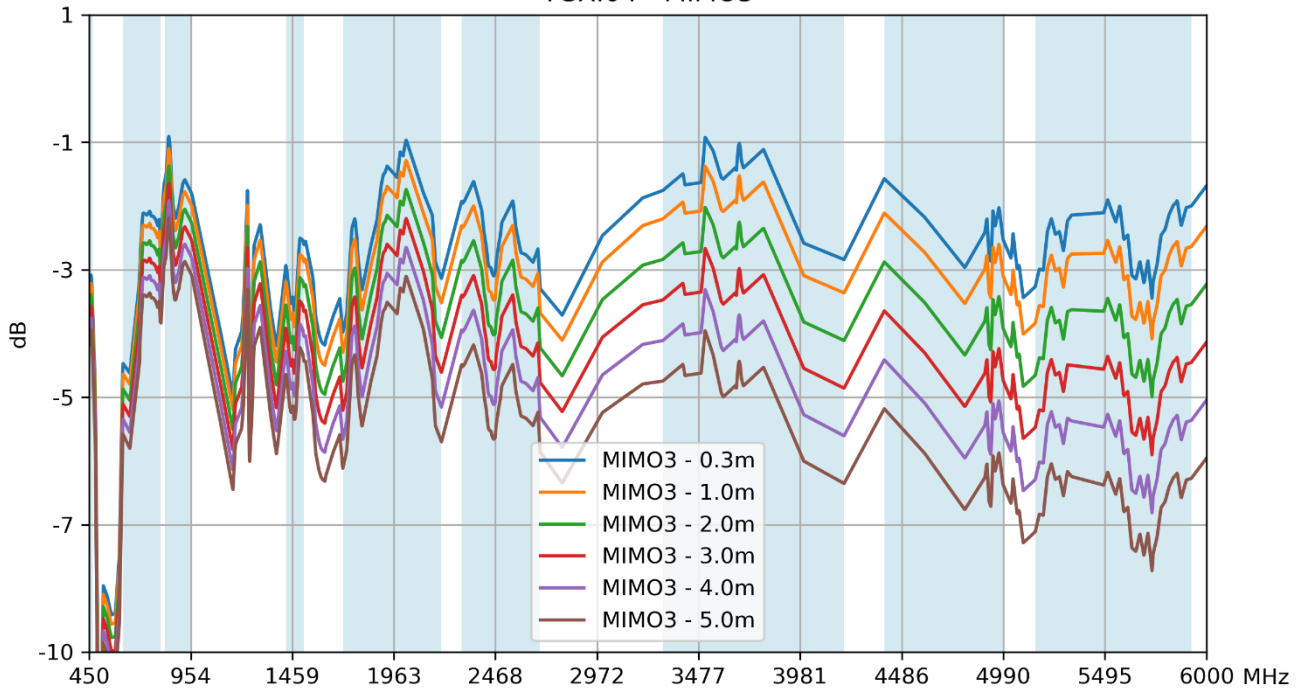

TGX.04 - MIMO4

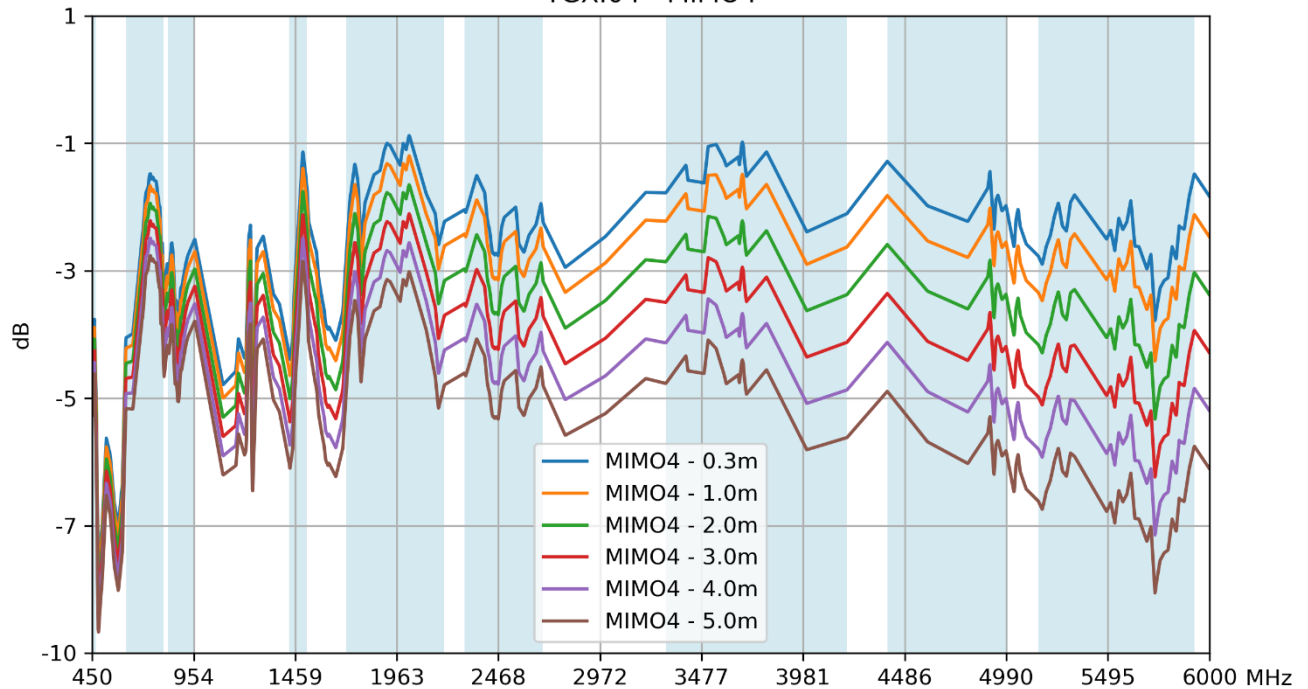

8.4 Comparison Table

Frequency (MHz)	LTE 450	5GNR B71	LTE 700	LTE 800/900	5GNR 1500	5GNR n66	LTE 2600	5GNR n77	5GNR n78	5GNR n79	LTE 5200	
	450-470	610-698	698-806	824-960	1427-1518	1710-2200	2300-2690	3300-4200	3300-3800	4400-5000	5150-5925	
Efficiency (%)												
MIMO1	0.3m	41.2	38.4	60.2	69.0	55.3	68.2	55.2	67.7	68.8	59.8	52.5
	1.0m	39.9	36.7	57.4	65.7	51.8	62.8	50.1	59.8	60.8	51.9	44.9
	2.0m	38.1	34.4	53.5	61.3	47.2	55.8	43.6	50.1	51.0	42.2	35.9
	3.0m	36.4	32.3	50.0	57.2	43.0	49.7	38.0	42.0	42.8	34.4	28.7
	4.0m	34.8	30.3	46.6	53.4	39.2	44.2	33.1	35.2	35.9	28.0	23.0
	5.0m	33.2	28.4	43.5	49.9	35.7	39.3	28.8	29.5	30.1	22.8	18.4
MIMO2	0.3m	44.7	31.8	41.3	60.3	56.1	57.9	49.4	65.9	67.1	60.9	53.0
	1.0m	43.3	30.4	39.3	57.5	52.6	53.3	44.9	58.2	59.3	52.7	45.3
	2.0m	41.3	28.5	36.7	53.7	47.9	47.4	39.1	48.8	49.7	43.0	36.2
	3.0m	39.5	26.7	34.3	50.1	43.7	42.1	34.0	40.9	41.7	35.0	29.0
	4.0m	37.7	25.1	32.0	46.7	39.8	37.5	29.7	34.3	35.0	28.5	23.2
	5.0m	36.0	23.5	29.8	43.6	36.2	33.3	25.8	28.7	29.4	23.2	18.5
MIMO3	0.3m	42.0	34.5	54.7	64.4	44.2	58.7	50.8	67.7	69.7	54.1	52.2
	1.0m	40.6	33.0	52.1	61.4	41.4	54.1	46.2	59.8	61.6	46.8	44.6
	2.0m	38.8	30.9	48.6	57.3	37.7	48.1	40.2	50.1	51.7	38.2	35.7
	3.0m	37.1	29.0	45.4	53.5	34.3	42.7	35.0	42.0	43.3	31.1	28.5
	4.0m	35.4	27.1	42.4	49.9	31.3	38.0	30.5	35.2	36.4	25.3	22.8
	5.0m	33.8	25.4	39.5	46.6	28.5	33.8	26.6	29.5	30.5	20.6	18.2
MIMO4	0.3m	33.4	40.4	60.3	44.7	49.2	66.4	54.0	69.1	70.7	60.9	51.9
	1.0m	32.4	38.6	57.5	42.6	46.0	61.1	49.0	61.1	62.5	52.8	44.4
	2.0m	30.9	36.2	53.6	39.8	41.9	54.4	42.7	51.2	52.4	43.0	35.5
	3.0m	29.5	33.9	50.1	37.1	38.2	48.3	37.2	42.9	43.9	35.0	28.4
	4.0m	28.2	31.8	46.7	34.6	34.8	43.0	32.4	35.9	36.9	28.5	22.7
	5.0m	26.9	29.8	43.6	32.3	31.7	38.2	28.2	30.1	30.9	23.2	18.2
Average Gain (dB)												
MIMO1	0.3m	-3.85	-4.15	-2.20	-1.61	-2.57	-1.66	-2.58	-1.69	-1.62	-2.23	-2.80
	1.0m	-3.99	-4.35	-2.41	-1.82	-2.86	-2.02	-3.00	-2.23	-2.16	-2.85	-3.48
	2.0m	-4.19	-4.63	-2.71	-2.12	-3.26	-2.53	-3.60	-3.00	-2.92	-3.74	-4.45
	3.0m	-4.39	-4.91	-3.01	-2.42	-3.67	-3.04	-4.20	-3.77	-3.69	-4.63	-5.42
	4.0m	-4.59	-5.19	-3.31	-2.72	-4.07	-3.55	-4.80	-4.53	-4.45	-5.52	-6.39
	5.0m	-4.79	-5.47	-3.61	-3.02	-4.48	-4.06	-5.40	-5.30	-5.21	-6.41	-7.36
MIMO2	0.3m	-3.50	-4.97	-3.84	-2.19	-2.51	-2.38	-3.06	-1.81	-1.73	-2.16	-2.75
	1.0m	-3.64	-5.17	-4.05	-2.40	-2.79	-2.73	-3.48	-2.35	-2.27	-2.78	-3.44
	2.0m	-3.84	-5.45	-4.35	-2.70	-3.20	-3.24	-4.08	-3.12	-3.03	-3.67	-4.41
	3.0m	-4.04	-5.73	-4.65	-3.00	-3.60	-3.76	-4.68	-3.89	-3.80	-4.56	-5.38

	4.0m	-4.24	-6.01	-4.95	-3.30	-4.00	-4.27	-5.28	-4.65	-4.56	-5.45	-6.35
	5.0m	-4.44	-6.29	-5.25	-3.60	-4.41	-4.78	-5.88	-5.42	-5.32	-6.34	-7.32
MIMO3	0.3m	-3.77	-4.62	-2.62	-1.91	-3.55	-2.31	-2.94	-1.70	-1.57	-2.67	-2.82
	1.0m	-3.91	-4.82	-2.83	-2.12	-3.83	-2.67	-3.36	-2.23	-2.10	-3.29	-3.50
	2.0m	-4.11	-5.10	-3.13	-2.42	-4.24	-3.18	-3.96	-3.00	-2.87	-4.18	-4.48
	3.0m	-4.31	-5.38	-3.43	-2.72	-4.65	-3.69	-4.56	-3.77	-3.63	-5.07	-5.45
	4.0m	-4.51	-5.66	-3.73	-3.02	-5.05	-4.20	-5.16	-4.54	-4.39	-5.96	-6.42
	5.0m	-4.71	-5.95	-4.03	-3.32	-5.46	-4.71	-5.76	-5.30	-5.16	-6.85	-7.39
MIMO4	0.3m	-4.76	-3.94	-2.19	-3.49	-3.08	-1.78	-2.68	-1.60	-1.51	-2.15	-2.85
	1.0m	-4.90	-4.13	-2.40	-3.70	-3.37	-2.14	-3.10	-2.14	-2.04	-2.78	-3.53
	2.0m	-5.10	-4.42	-2.70	-4.00	-3.77	-2.65	-3.70	-2.91	-2.81	-3.67	-4.50
	3.0m	-5.30	-4.70	-3.00	-4.30	-4.18	-3.16	-4.30	-3.68	-3.57	-4.56	-5.47
	4.0m	-5.50	-4.98	-3.30	-4.60	-4.59	-3.67	-4.90	-4.44	-4.33	-5.45	-6.44
	5.0m	-5.70	-5.26	-3.60	-4.90	-4.99	-4.18	-5.50	-5.21	-5.10	-6.34	-7.41
Peak Gain (dBi)												
MIMO1	0.3m	1.57	1.38	3.46	3.56	3.30	4.91	5.27	4.98	4.98	6.71	4.26
	1.0m	1.43	1.20	3.25	3.35	3.02	4.56	4.85	4.48	4.48	6.12	3.56
	2.0m	1.23	0.94	2.95	3.05	2.62	4.06	4.25	3.77	3.77	5.28	2.56
	3.0m	1.03	0.68	2.65	2.75	2.22	3.56	3.65	3.06	3.06	4.43	1.56
	4.0m	0.83	0.42	2.35	2.45	1.82	3.06	3.05	2.35	2.35	3.59	0.56
	5.0m	0.63	0.16	2.05	2.15	1.42	2.56	2.45	1.64	1.64	2.74	-0.44
MIMO2	0.3m	0.18	1.93	2.70	3.55	4.20	5.56	5.88	5.78	5.71	5.04	4.64
	1.0m	0.04	1.72	2.49	3.34	3.90	5.21	5.46	5.22	5.15	4.45	4.01
	2.0m	-0.16	1.42	2.19	3.04	3.47	4.71	4.86	4.42	4.35	3.60	3.11
	3.0m	-0.36	1.12	1.89	2.74	3.07	4.21	4.26	3.62	3.55	2.76	2.21
	4.0m	-0.56	0.82	1.59	2.44	2.67	3.71	3.66	2.82	2.75	1.91	1.31
	5.0m	-0.76	0.52	1.29	2.14	2.27	3.21	3.06	2.02	1.95	1.07	0.41
MIMO3	0.3m	0.34	0.22	1.70	3.10	2.38	4.61	5.44	6.37	6.37	4.23	5.00
	1.0m	0.20	0.01	1.49	2.89	2.10	4.26	5.02	5.81	5.81	3.64	4.30
	2.0m	-0.00	-0.29	1.19	2.59	1.70	3.76	4.42	5.01	5.01	2.80	3.30
	3.0m	-0.20	-0.59	0.89	2.29	1.30	3.26	3.82	4.21	4.21	1.95	2.30
	4.0m	-0.40	-0.89	0.59	1.99	0.90	2.76	3.22	3.41	3.41	1.11	1.30
	5.0m	-0.60	-1.19	0.29	1.69	0.50	2.26	2.62	2.61	2.61	0.26	0.30
MIMO4	0.3m	0.76	2.73	3.06	3.08	3.52	4.06	4.65	4.92	4.01	5.99	3.93
	1.0m	0.62	2.52	2.85	2.87	3.24	3.71	4.23	4.34	3.45	5.40	3.30
	2.0m	0.42	2.22	2.55	2.57	2.84	3.21	3.63	3.52	2.65	4.56	2.40
	3.0m	0.22	1.92	2.25	2.27	2.44	2.71	3.03	2.70	1.85	3.71	1.50
	4.0m	0.02	1.62	1.95	1.97	2.04	2.21	2.43	1.88	1.05	2.87	0.60
	5.0m	-0.18	1.32	1.65	1.67	1.64	1.71	1.83	1.05	0.25	2.03	-0.30

Changelog for the datasheet

SPE-23-8-025 – TGX.04.W.A.001

Revision: A (Original First Release)	
Date:	2023-02-20
Notes:	
Author:	Jack Conroy

Previous Revisions



www.taoglas.com

