



Datasheet

Triton

Part No:
TG.10.0113

Features:

5G/4G Cellular Antenna
600-6000MHz Operational
Dipole Terminal Antenna
Hinged SMA(M) Connector
Dimensions: 168*18*13mm
CE Certified
RoHS and REACH Compliant

1. Introduction	3
2. Specifications	4
3. Antenna Characteristics	5
4. Radiation Patterns	7
5. Mechanical Drawing	48
6. Installation Guide	49
7. Packaging	50
<hr/>	
Changelog	51

Taoglas makes no warranties based on the accuracy or completeness of the contents of this document and reserves the right to make changes to specifications and product descriptions at any time without notice. Taoglas reserves all rights to this document and the information contained herein. Reproduction, use or disclosure to third parties without express permission is strictly prohibited.



1. Introduction



The TG.10 Triton is a dipole 5G/4G antenna designed for use with the next generation of router and gateway applications. Covering the full 600-6000MHz cellular frequency spectrum, the TG.10 Triton is ideal for applications where a wideband dipole antenna may be required. The TG.10 Triton can also be used for NB-IoT, Cat-M, assisted GNSS and dual-band Wi-Fi and due to its full spectrum coverage is backwards compatible with legacy technologies such as 3G and GSM.

The TG.10 Triton has a sleek yet robust PC+ABS enclosure, which makes it ideal for mounting onto routers which are often using this PC+ABS material.

Typical applications include:

- Gateways and Routers
- In-Building Connectivity Systems
- Point of Sales Kiosks
- Connected Industries
- Smart Metering

The TG.10 Triton is supplied with a hinged SMA connector for ease of mounting in MIMO systems. The dimensions of the TG.10 are 168*18*13mm meaning it can be covertly installed on routers and other similar devices unlike some of the bulkier products on the market. For further information please contact your regional Taoglas customer support team.

2. Specifications

Electrical										
Frequency (MHz)	5G Band 71	LTE700	GSM800 900	GNSS L1	5G NR N66	LTE2600	5G NR N77	5G NR N78	5G NR N79	LTE5200
	617-698	698-824	824-960	1563-1587	1710-2200	2300-2690	3300-4200	3300-3800	4400-5000	5150-5925
Efficiency (%)										
Bent - 15 X 9cm ground plane	45.7	69.1	61.0	27.5	74.6	65.4	37.5	38.0	49.2	42.5
Straight – 15 X 9cm ground plane	45.1	64.5	54.7	22.4	75.0	59.7	35.9	37.1	47.3	39.8
Bent - free space	34.2	39.0	31.8	24.8	54.3	55.2	42.1	42.9	54.2	50.8
straight - free space	35.8	41.0	32.4	24.8	43.7	36.5	36.8	38.3	44.8	51.5
Average Gain (dB)										
Bent - 15 X 9cm ground plane	-3.40	-1.60	-2.14	-5.61	-1.27	-1.84	-4.26	-4.21	-3.08	-3.71
Straight – 15 X 9cm ground plane	-3.46	-1.90	-2.62	-6.49	-1.25	-2.24	-4.45	-4.31	-3.25	-4.00
Bent - free space	-4.66	-4.09	-4.97	-6.06	-2.65	-2.58	-3.76	-3.67	-2.66	-2.94
straight - free space	-4.46	-3.88	-4.89	-6.06	-3.59	-4.38	-4.35	-4.17	-3.49	-2.88
Peak Gain (dBi)										
Bent - 15 X 9cm ground plane	0.64	3.16	2.82	-0.59	3.98	5.05	5.63	5.63	5.68	4.48
Straight – 15 X 9cm ground plane	2.93	4.60	4.28	-1.67	4.16	4.19	3.45	3.45	3.89	3.43
Bent - free space	1.95	2.97	2.10	-2.99	2.08	2.29	3.12	3.12	5.59	2.89
straight - free space	2.73	3.42	2.84	-2.69	2.33	2.56	3.73	3.73	2.15	3.42
Impedance		50 Ω								
Polarization		Linear								
Radiation Pattern		Omni								
Max. input power		5W								

Mechanical	
Dimensions	Length 168*18*13mm,Φ13mm
Weight	24g
Material	PC+ABS
Recommended Torque for Mounting	0.9 N·m
Max Torque for Mounting	1.176 N·m
Environmental	
Temperature Range	-40°C to 85°C

3. Antenna Characteristics

3.1 Return Loss

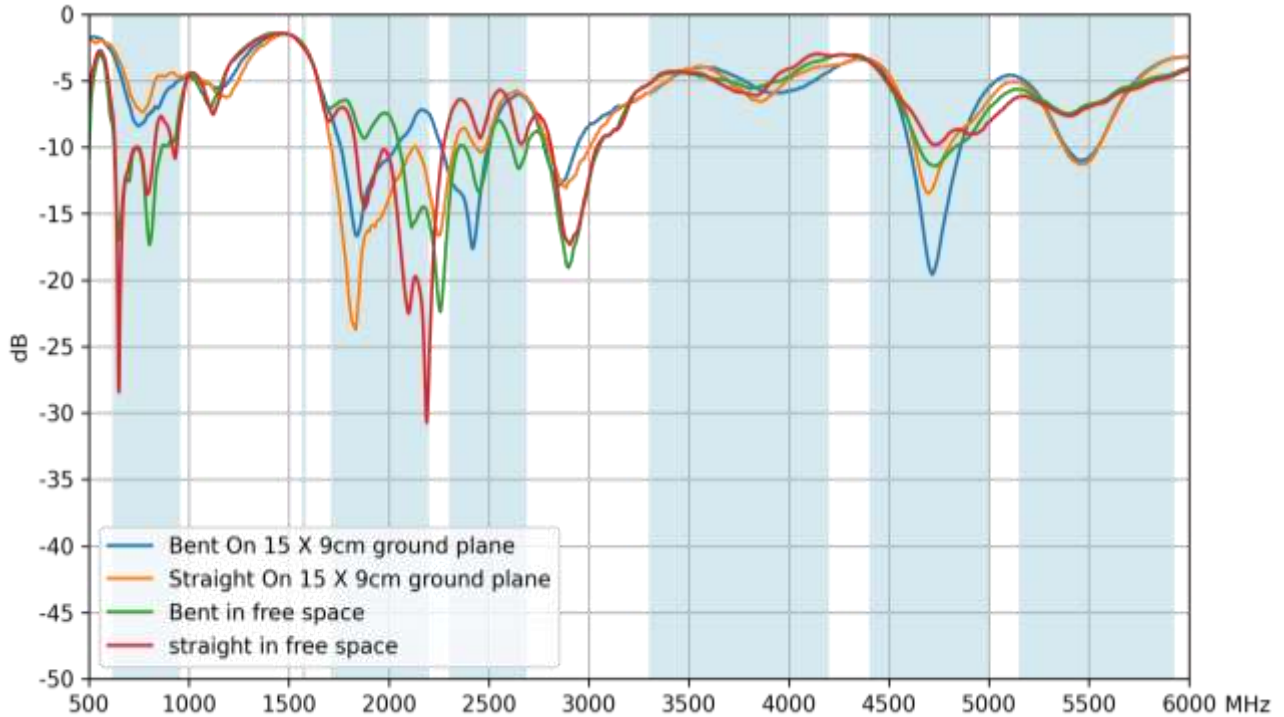

3.2 Efficiency

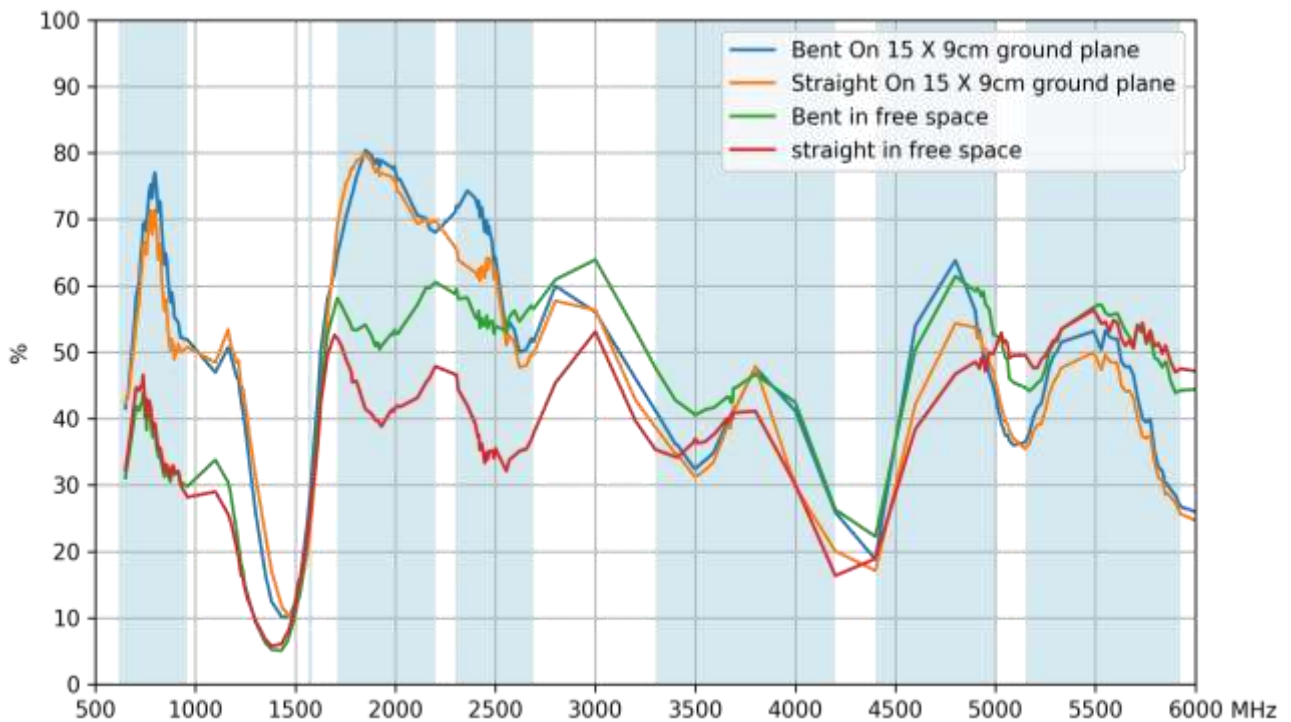

3.3 Average Gain

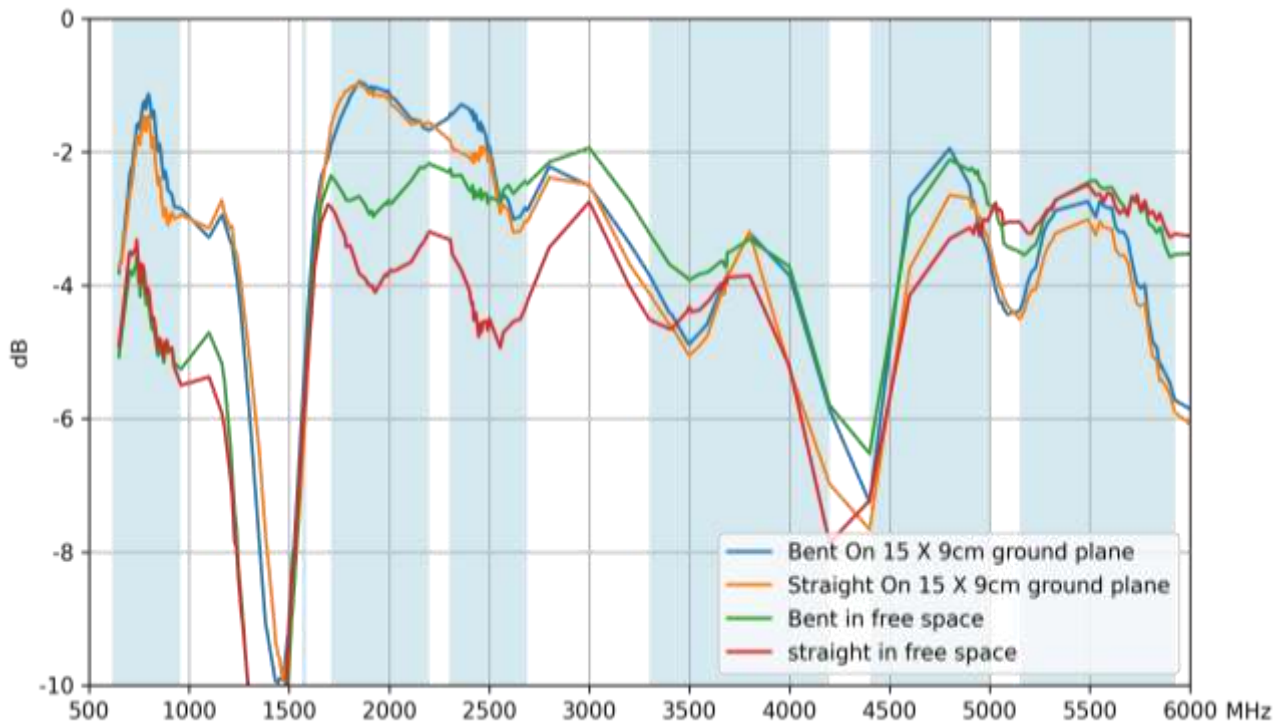

3.4 Peak Gain

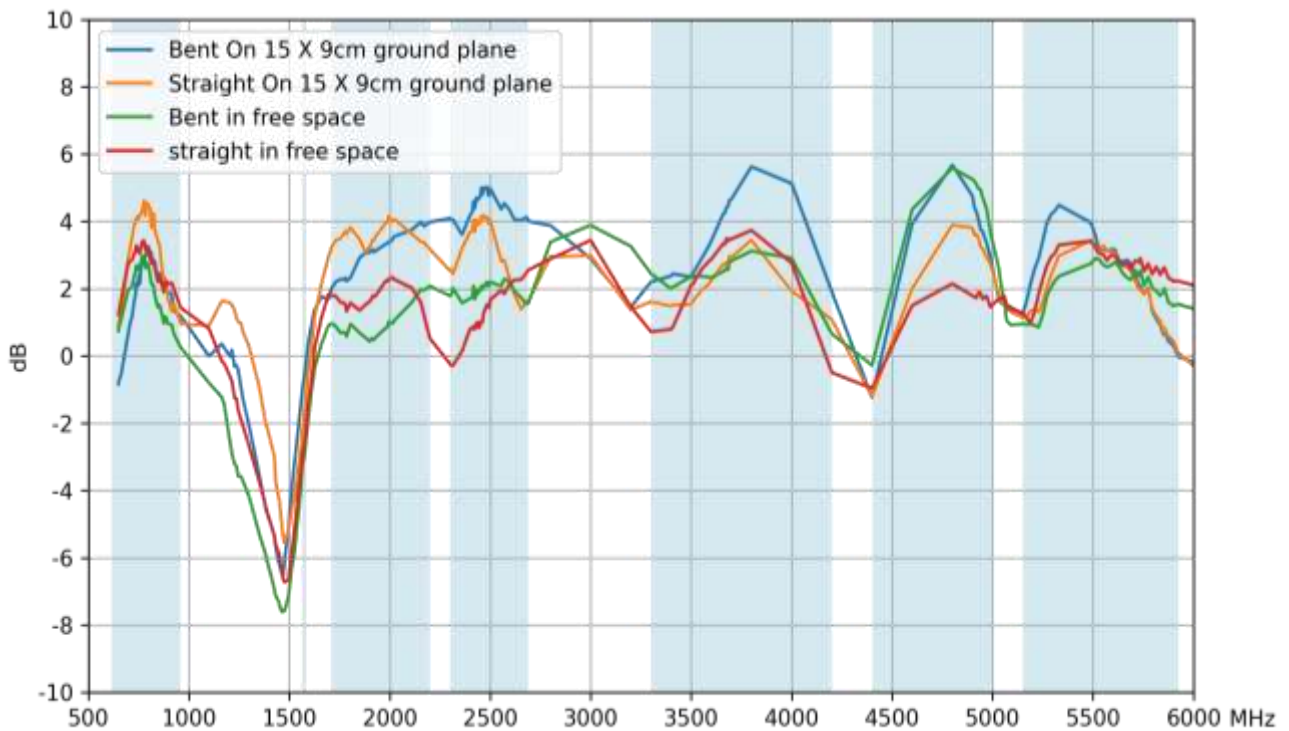

4. Radiation Patterns

4.1 Test Setup

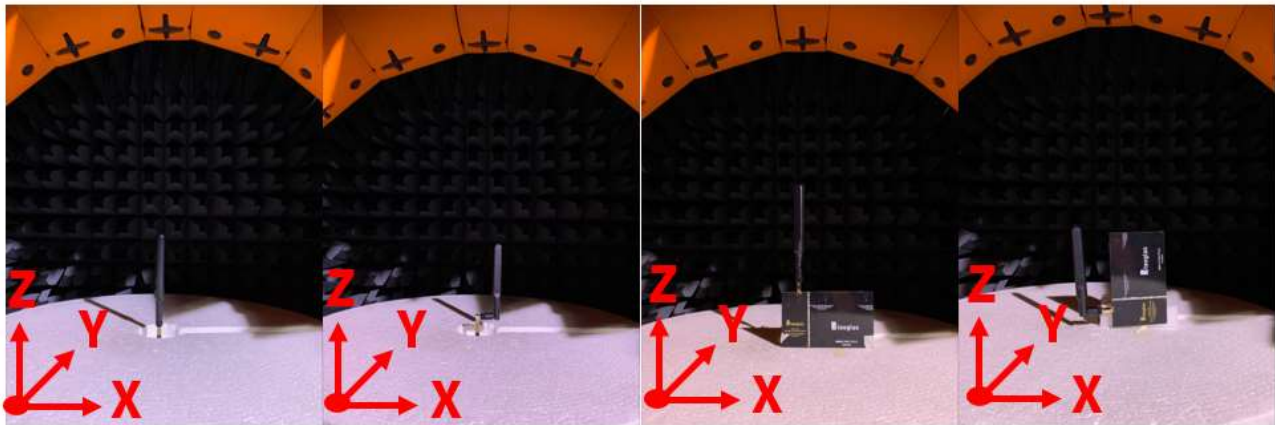

Straight in Free space

Bent in Free space

Straight On 15 X 9cm
Ground plane

Bent On 15 X 9cm
Ground plane

4.2 Bent On 15 X 9cm Ground Plane 3D & 2D Radiation Patterns

Gain total, 652MHz

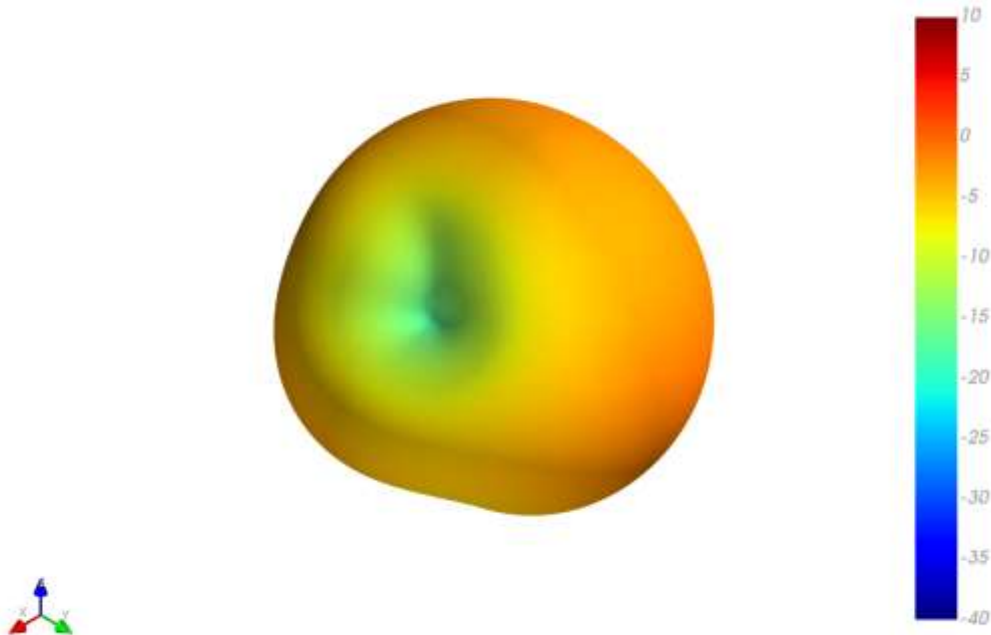

XY Plane

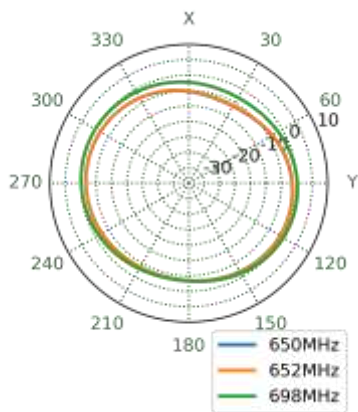

XZ Plane

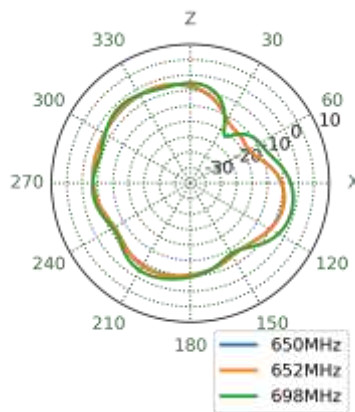

YZ Plane

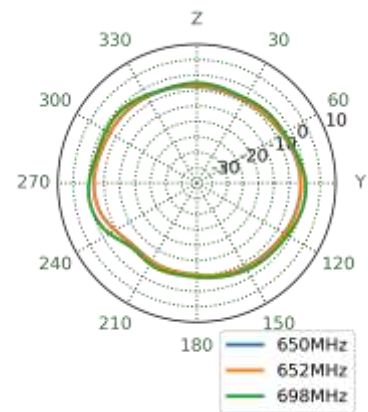

Gain total, 751MHz

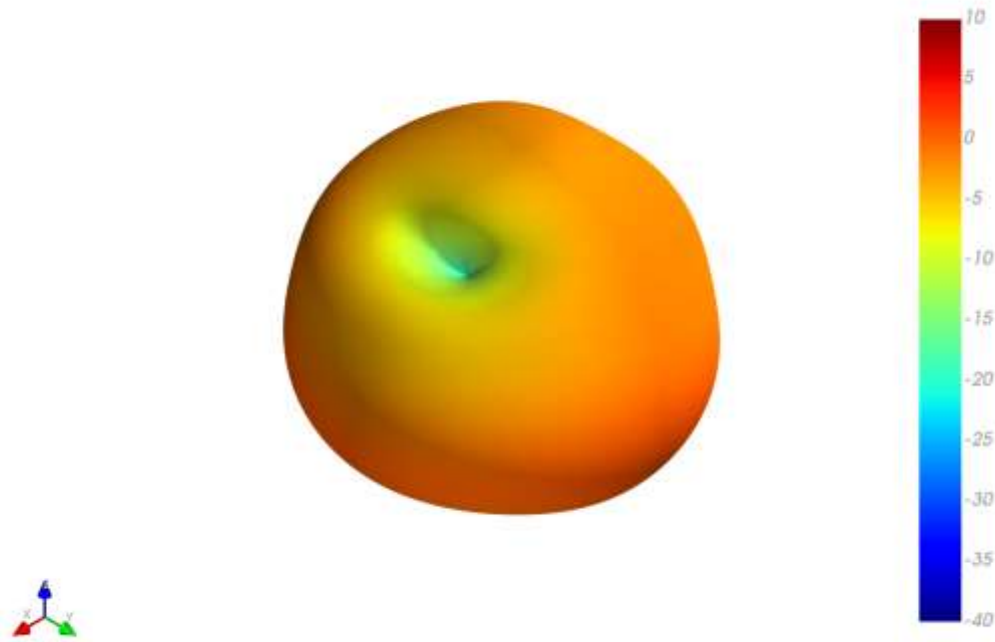

XY Plane XZ Plane YZ Plane

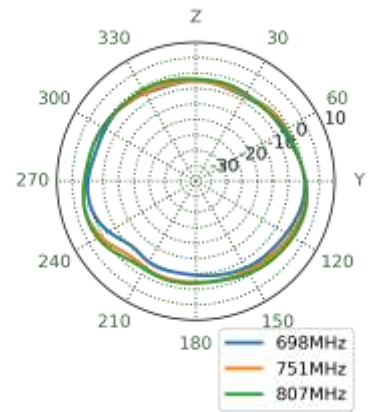
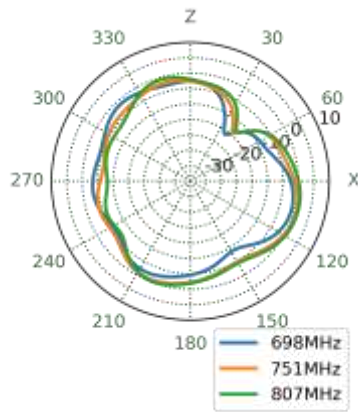
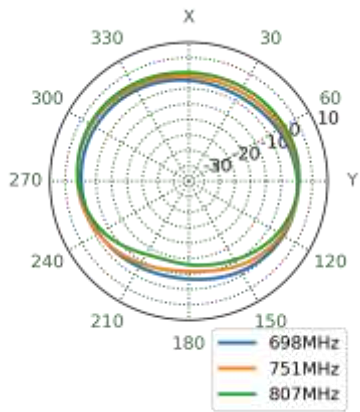

Gain total, 890MHz

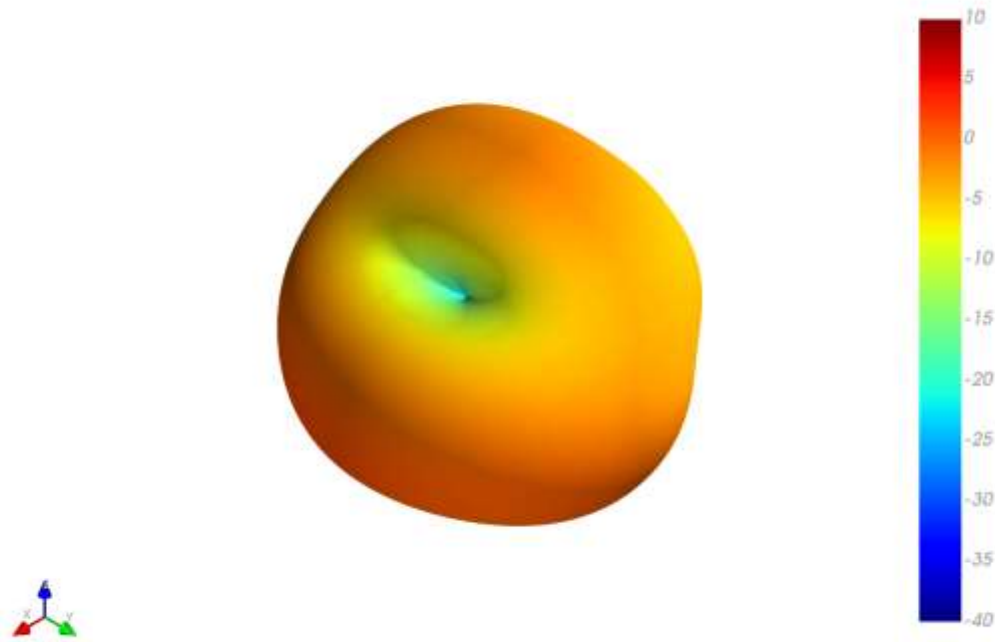

XY Plane XZ Plane YZ Plane

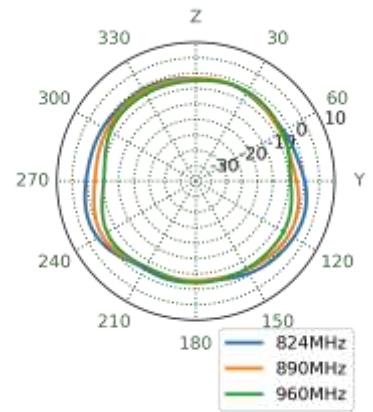
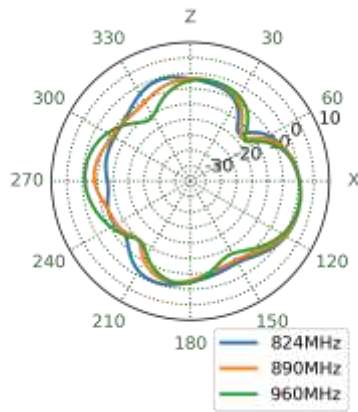
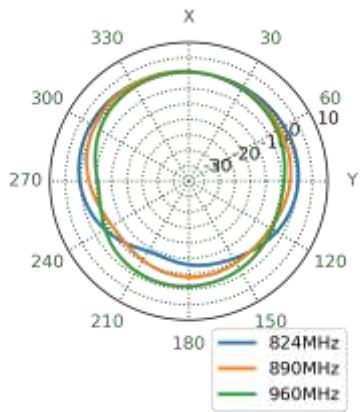

Gain total, 1575MHz

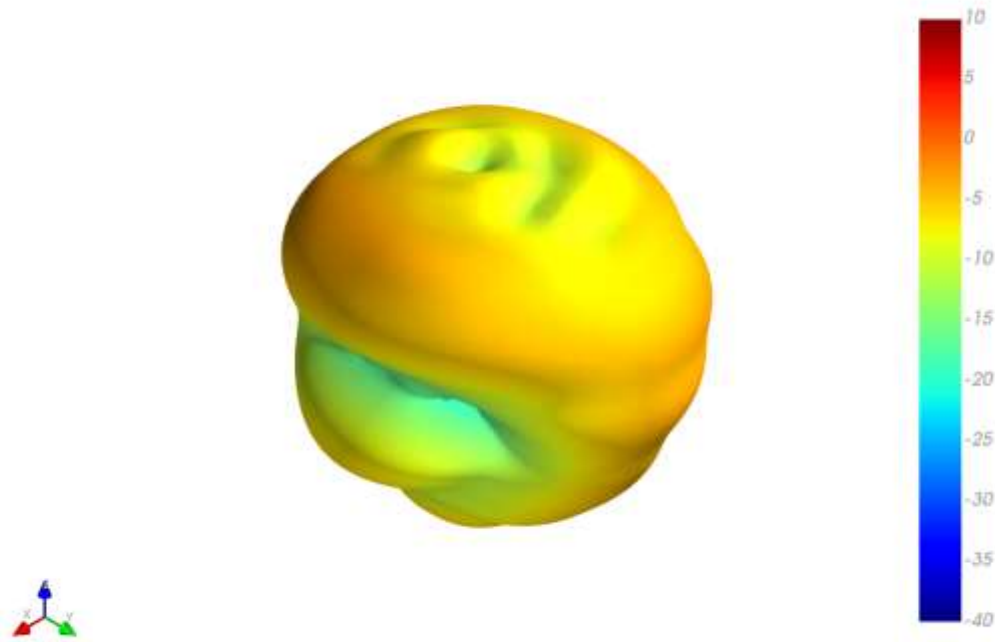

XY Plane XZ Plane YZ Plane

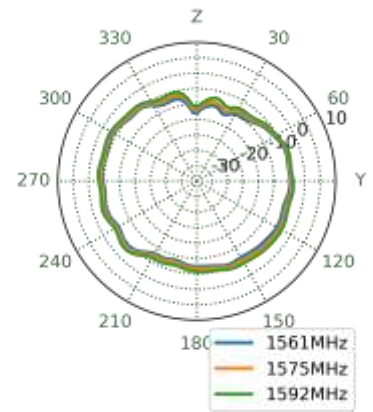
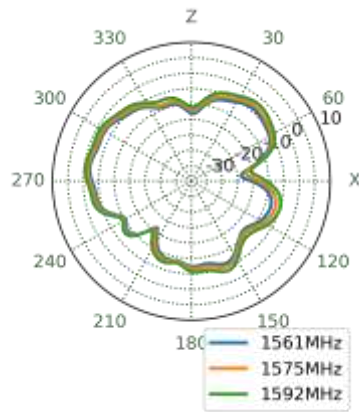
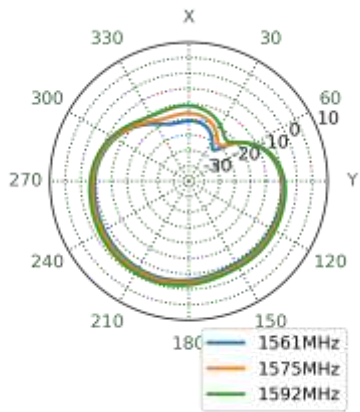

Gain total, 1805MHz

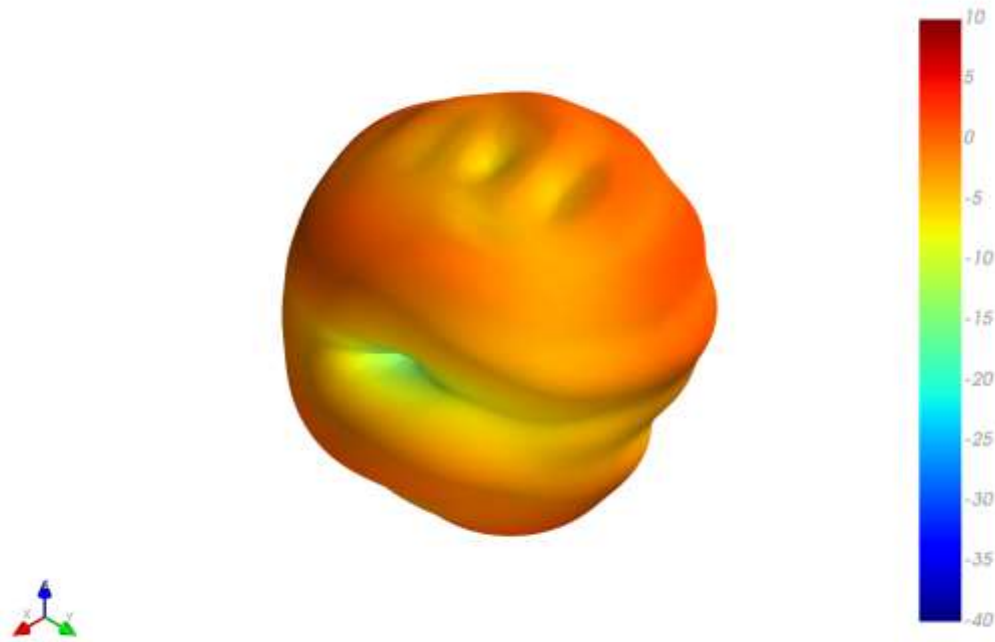

XY Plane XZ Plane YZ Plane

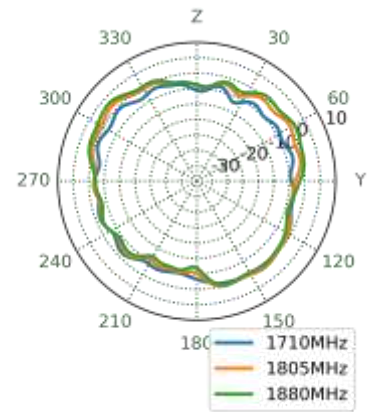
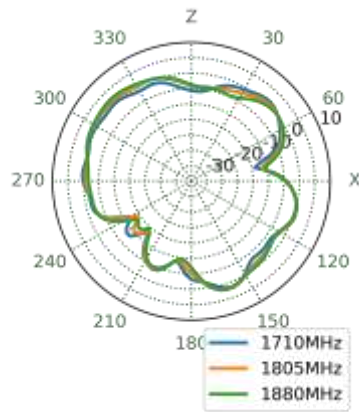
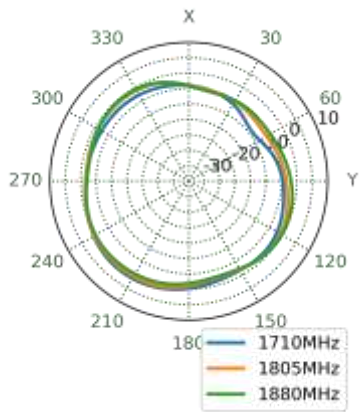

Gain total, 1920MHz

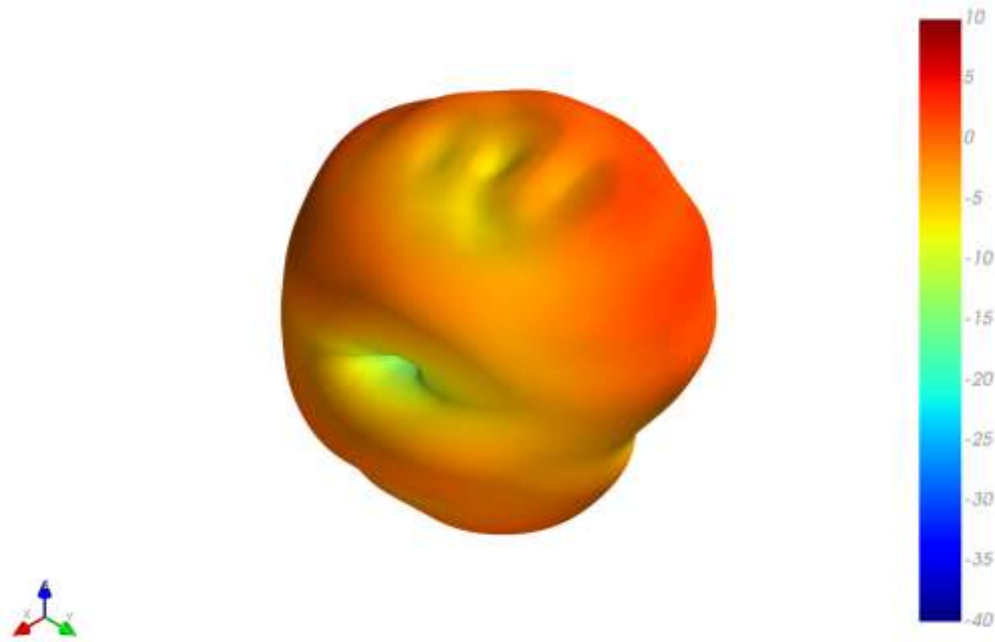

XY Plane XZ Plane YZ Plane

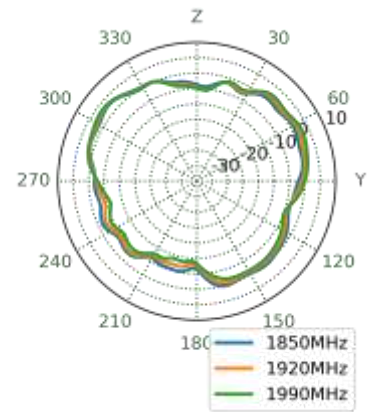
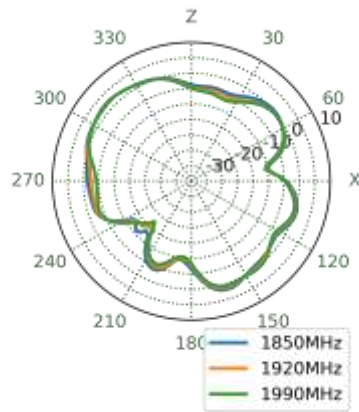
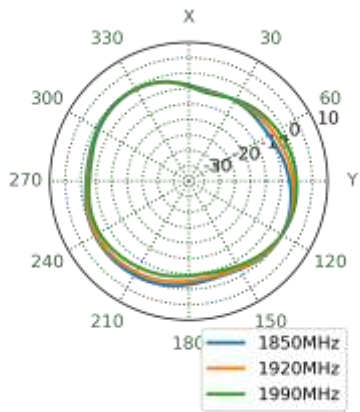

Gain total, 1990MHz

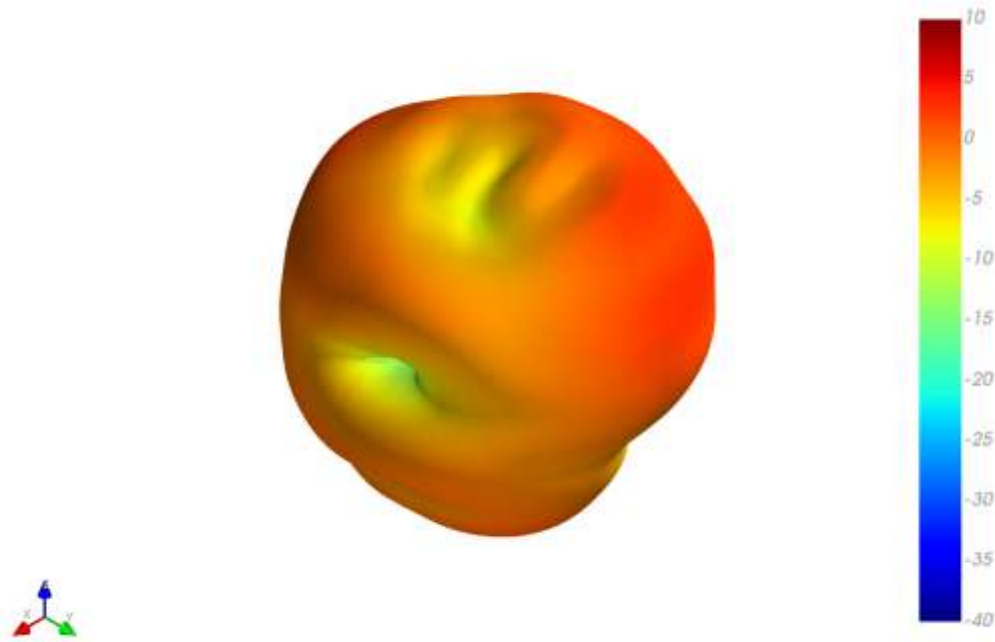

XY Plane YZ Plane YZ Plane

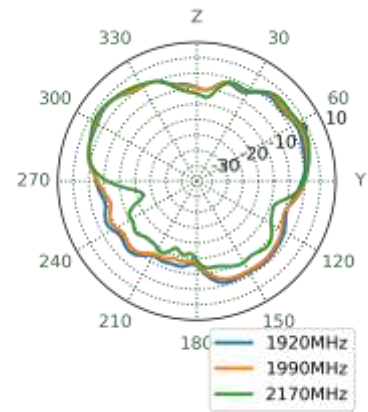
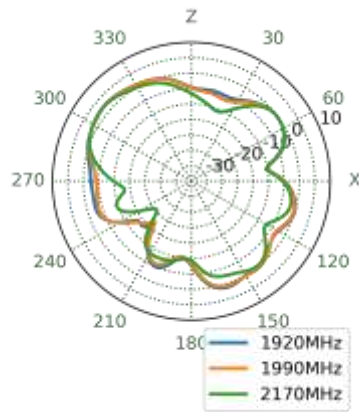
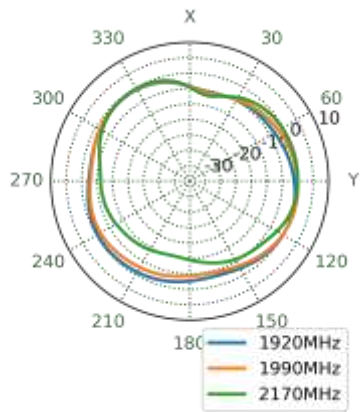

Gain total, 2595MHz

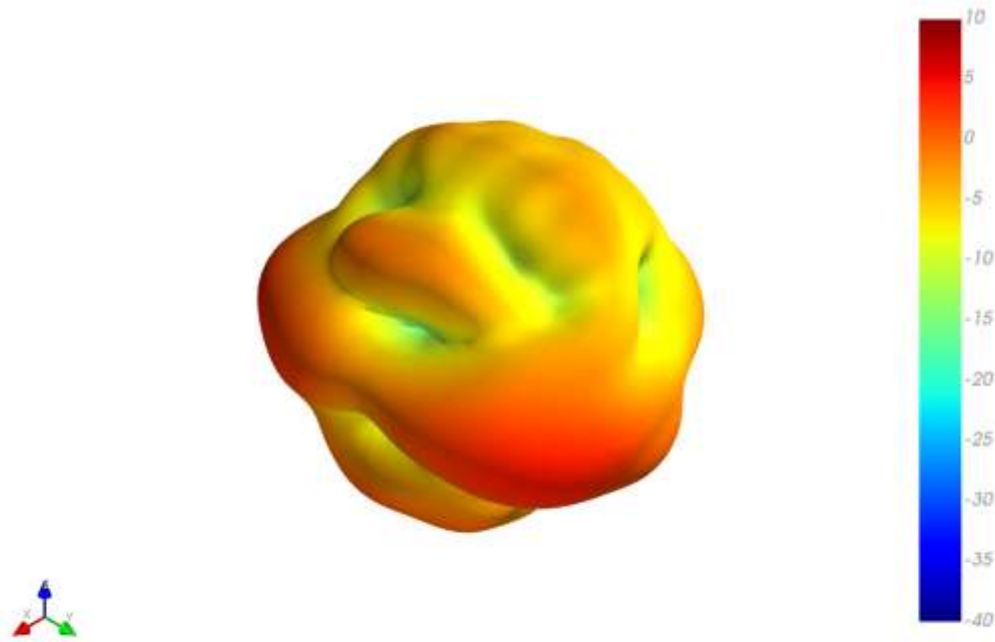

XY Plane XZ Plane YZ Plane

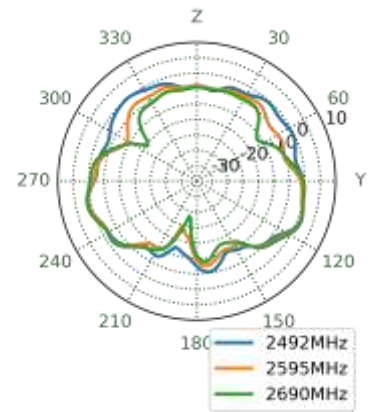
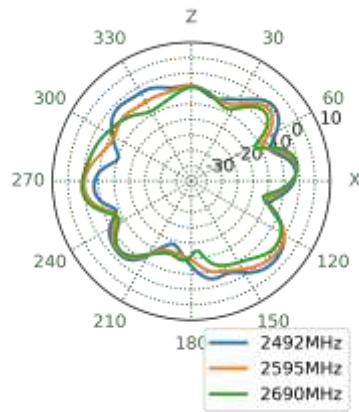
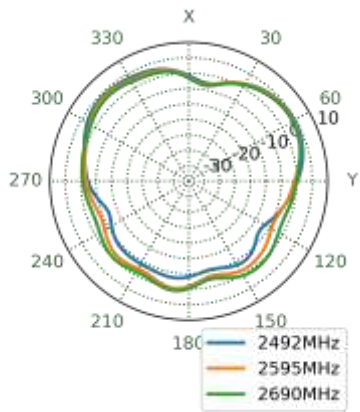

Gain total, 3550MHz

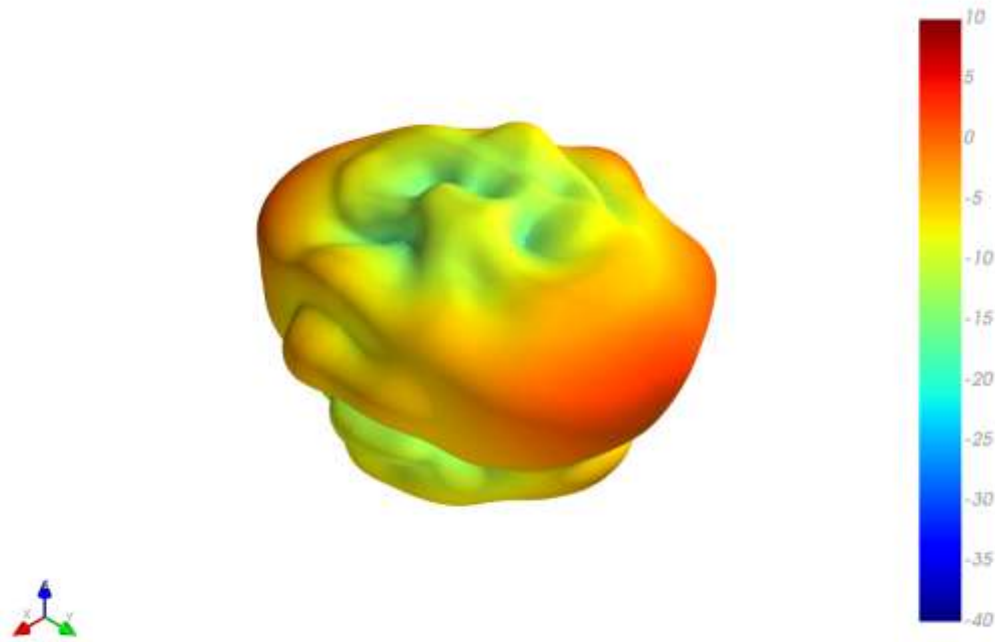

XY Plane XZ Plane YZ Plane

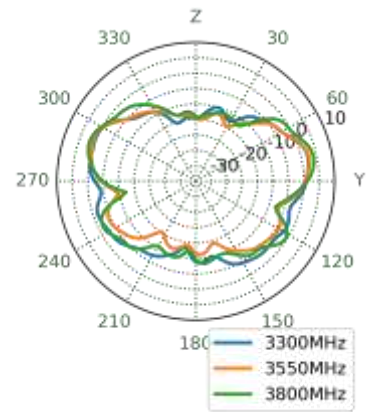
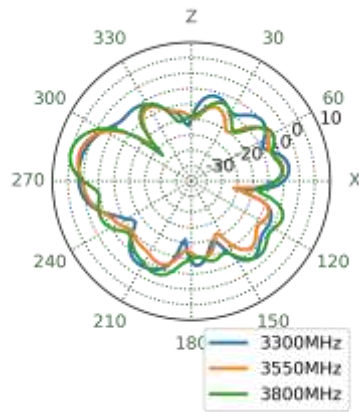
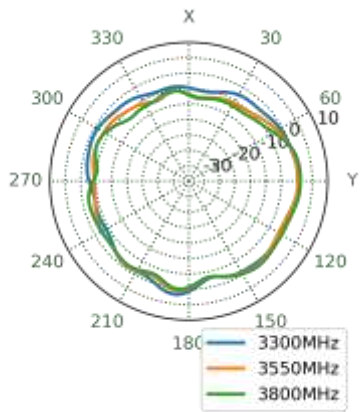

Gain total, 5530MHz

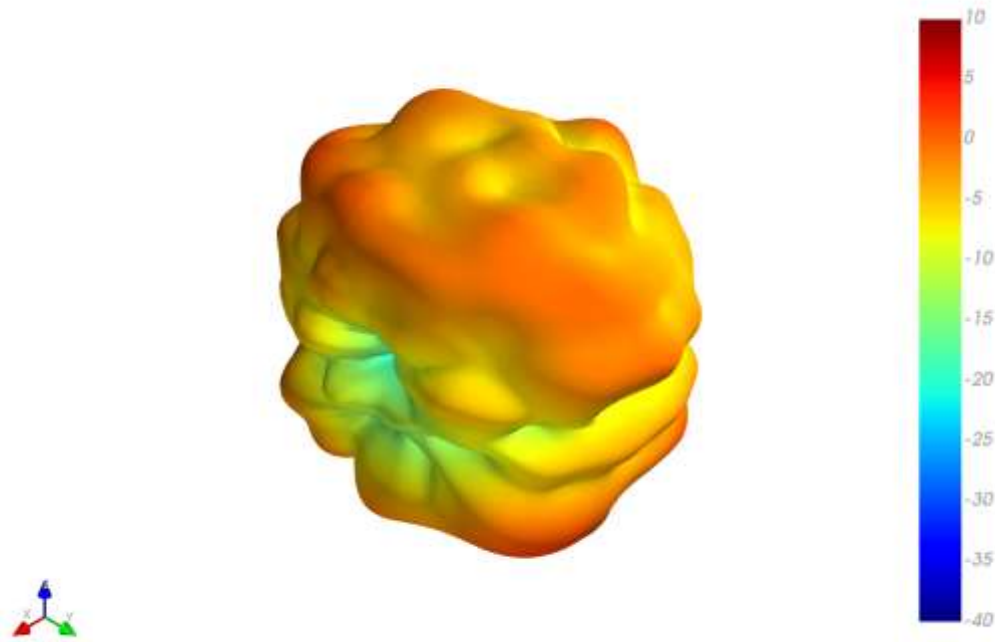

XY Plane XZ Plane YZ Plane

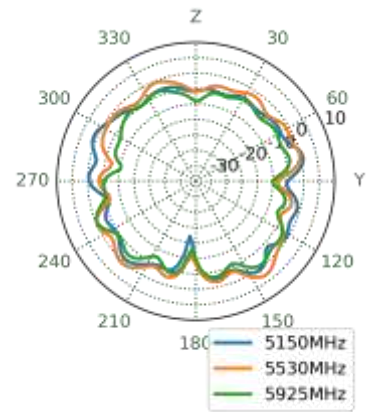
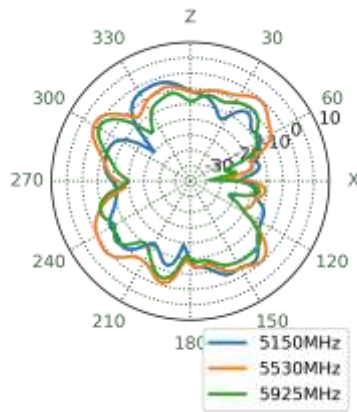
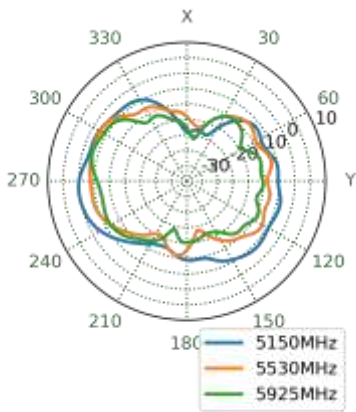

4.3 Straight On 15 X 9cm Ground Plane 3D & 2D Radiation Patterns

Gain total, 652MHz

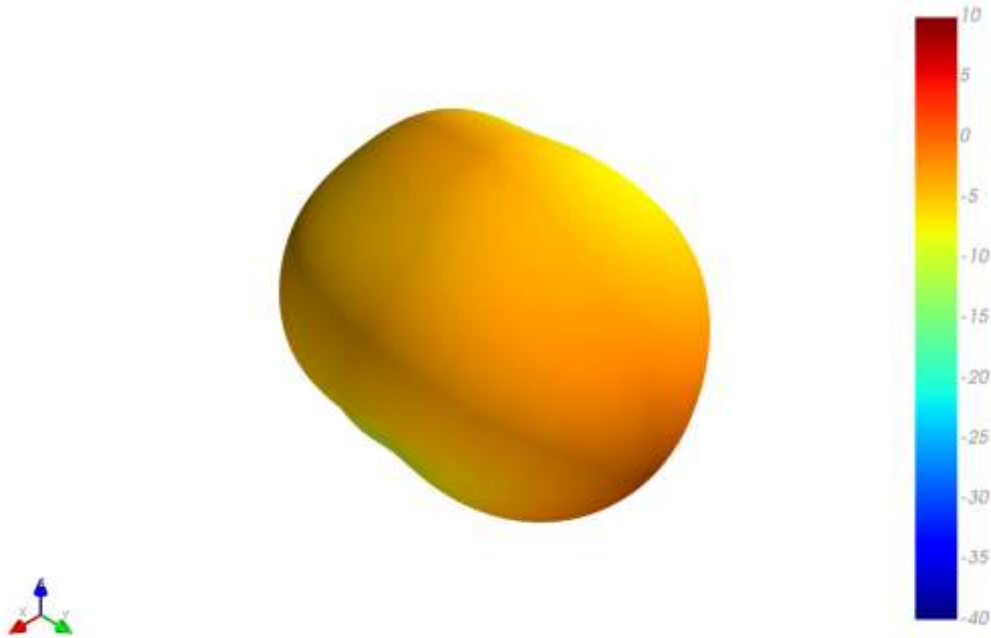

XY Plane

XZ Plane

YZ Plane

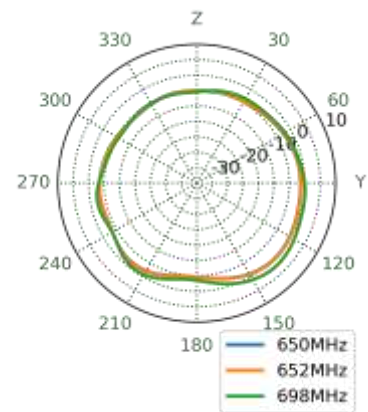
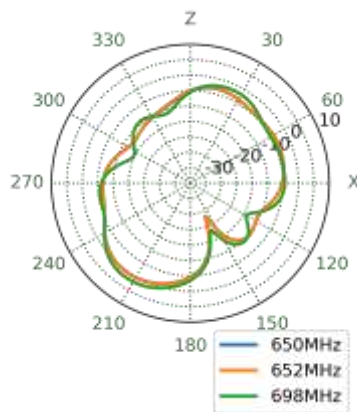
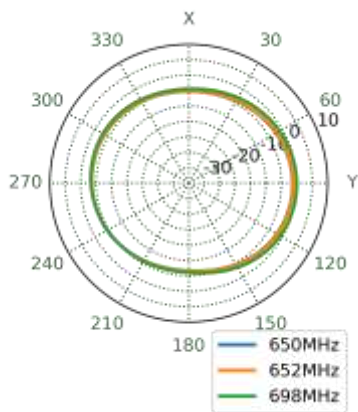

Gain total, 751MHz

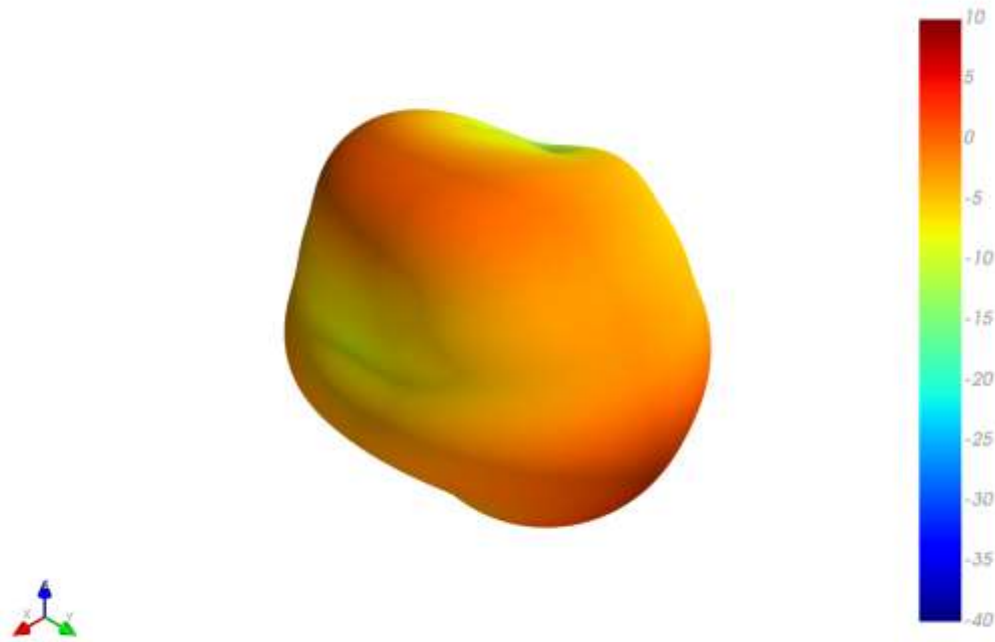

XY Plane XZ Plane YZ Plane

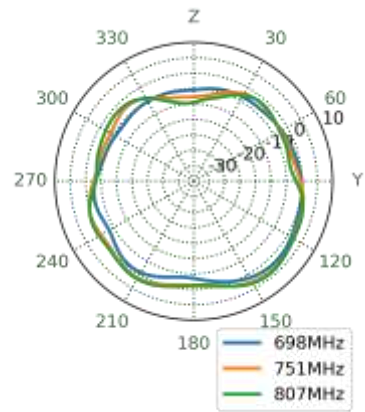
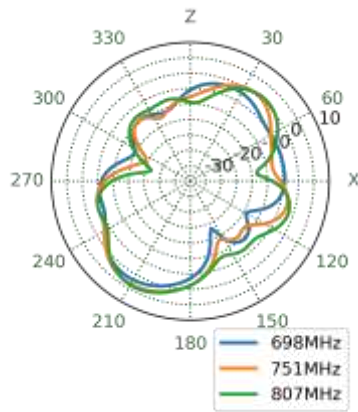
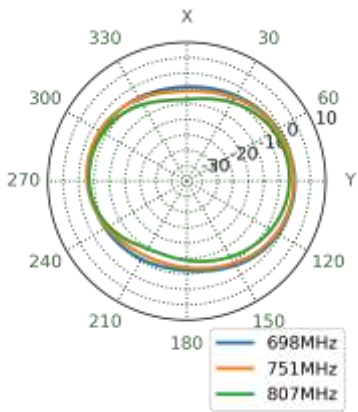

Gain total, 890MHz

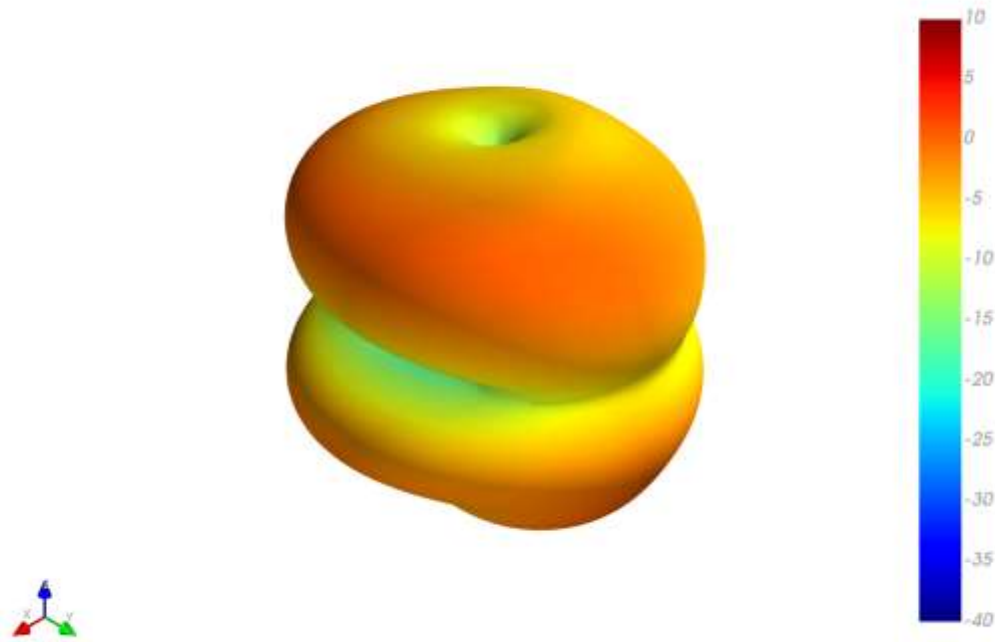

XY Plane XZ Plane YZ Plane

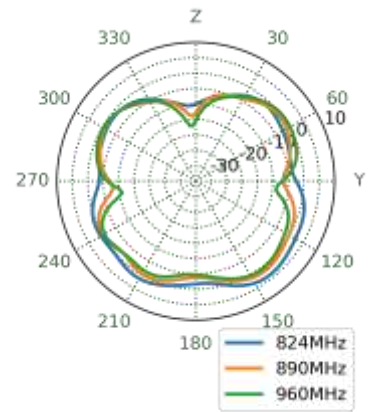
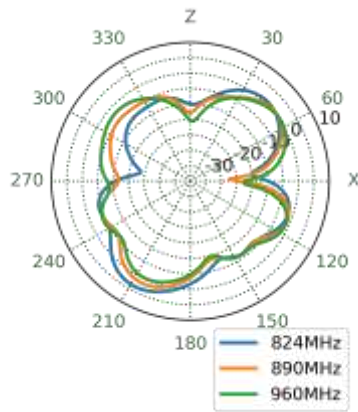
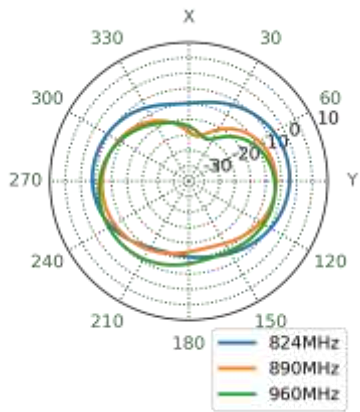

Gain total, 1575MHz

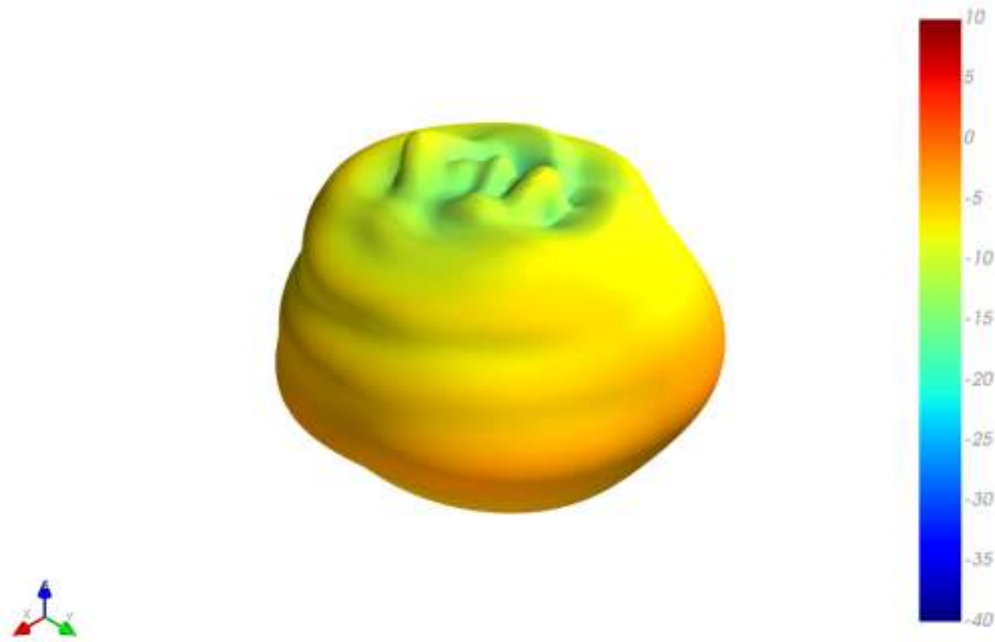

XY Plane XZ Plane YZ Plane

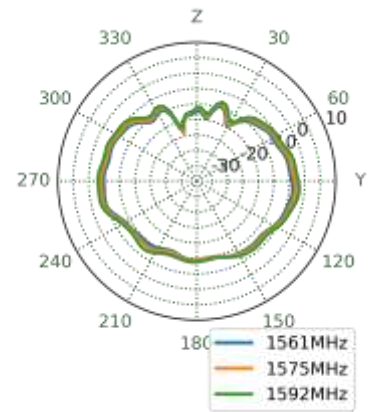
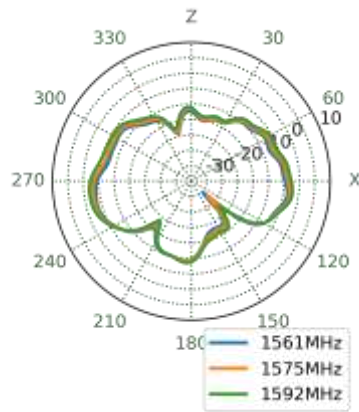
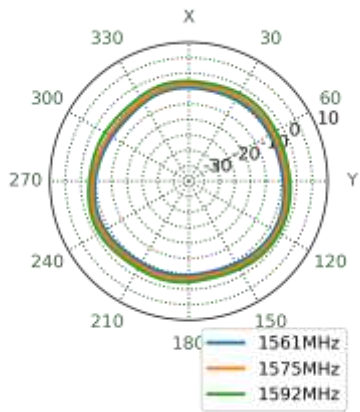

Gain total, 1805MHz

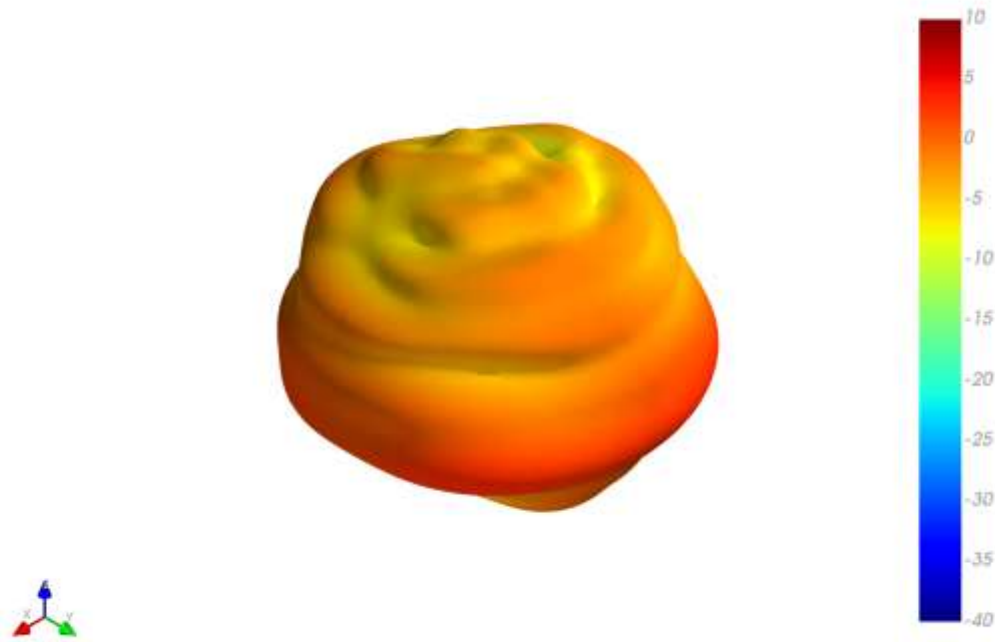

XY Plane XZ Plane YZ Plane

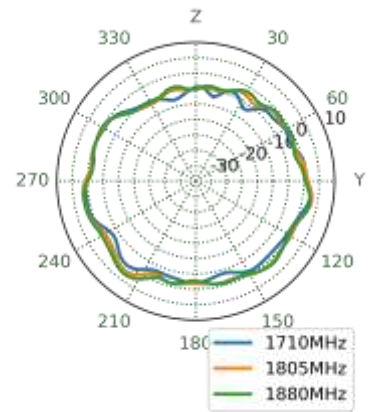
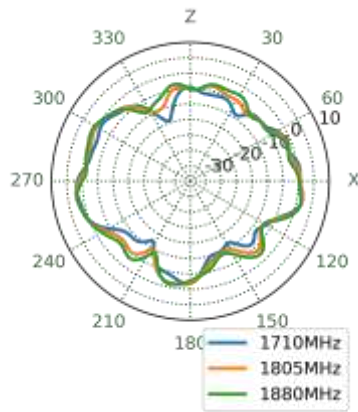
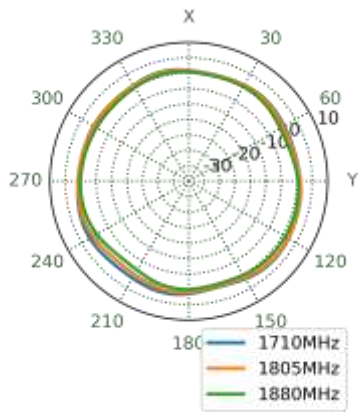

Gain total, 1920MHz

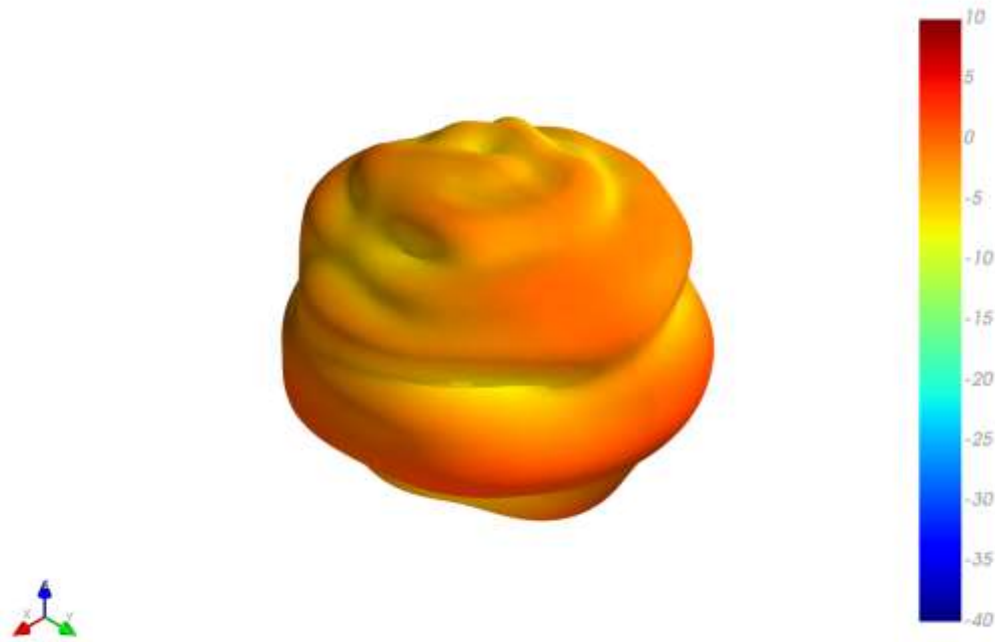

XY Plane XZ Plane YZ Plane

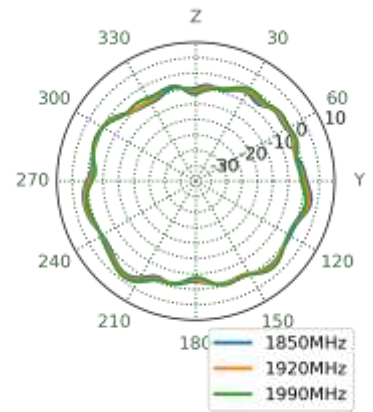
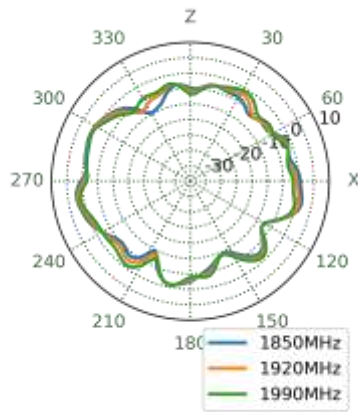
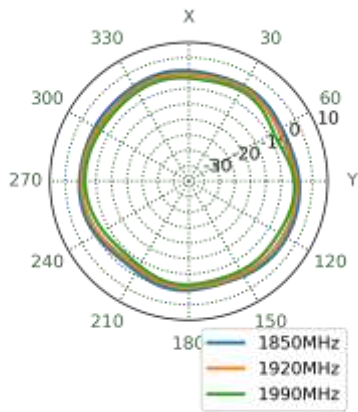

Gain total, 1990MHz

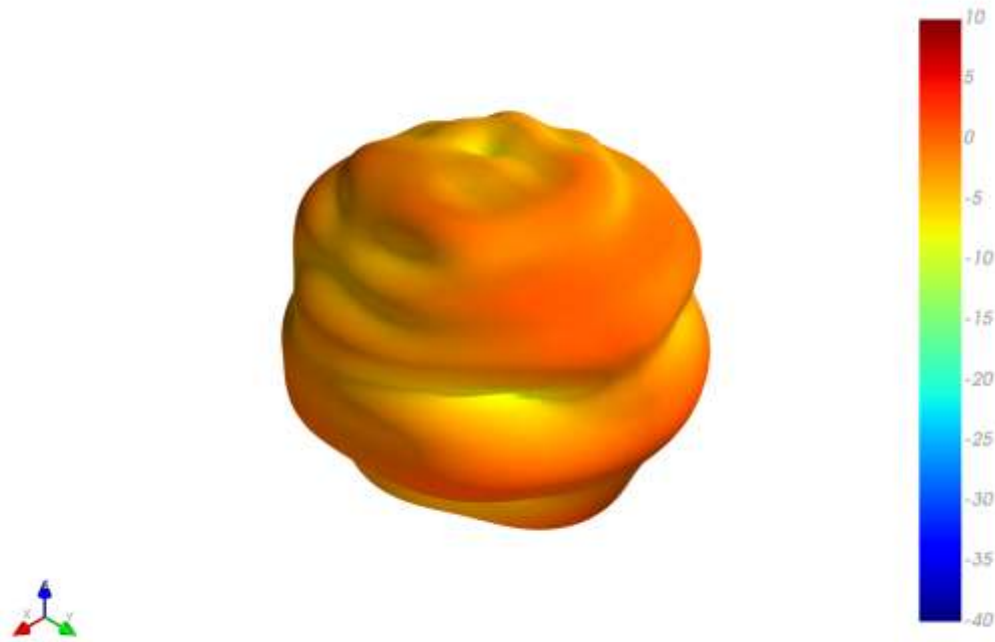

XY Plane XZ Plane YZ Plane

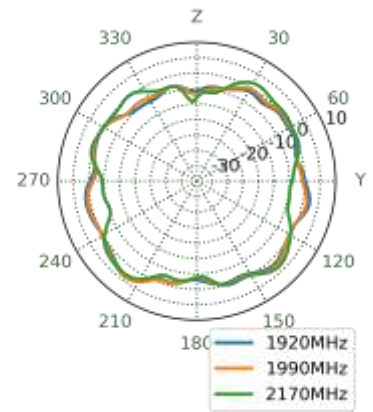
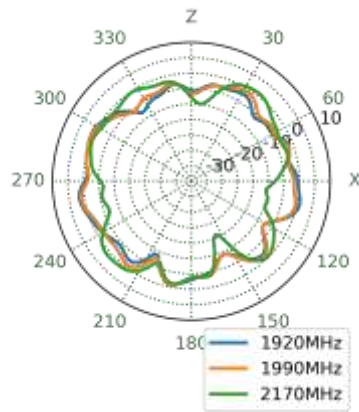
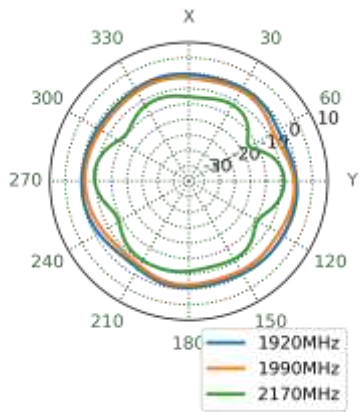

Gain total, 2595MHz

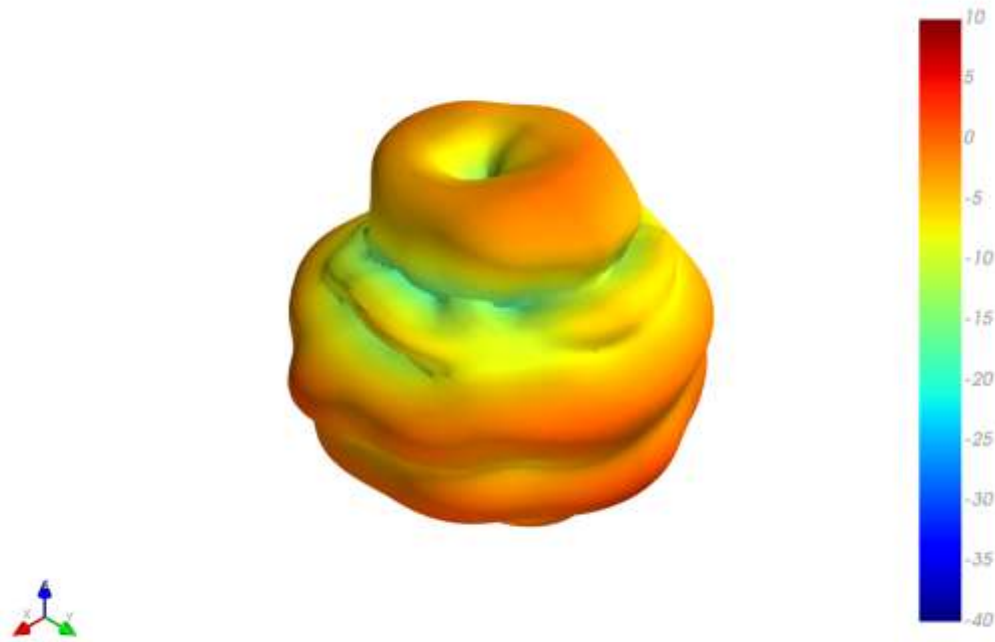

XY Plane XZ Plane YZ Plane

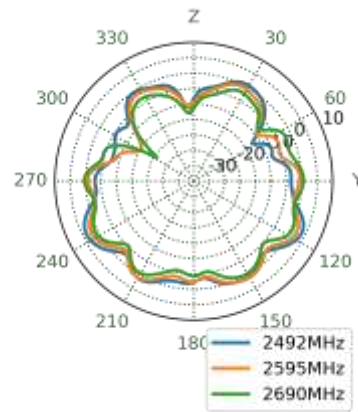
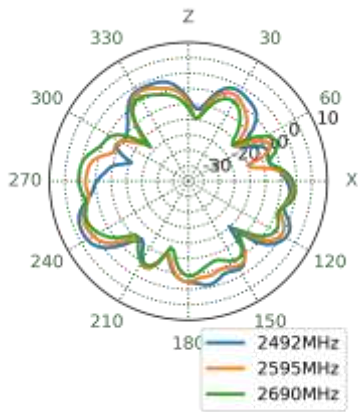
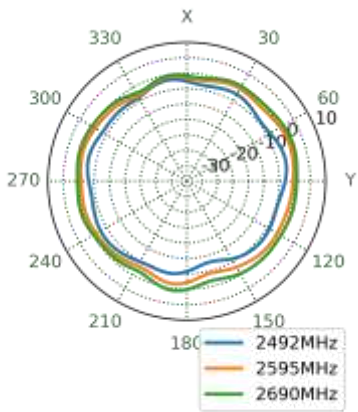

Gain total, 3550MHz

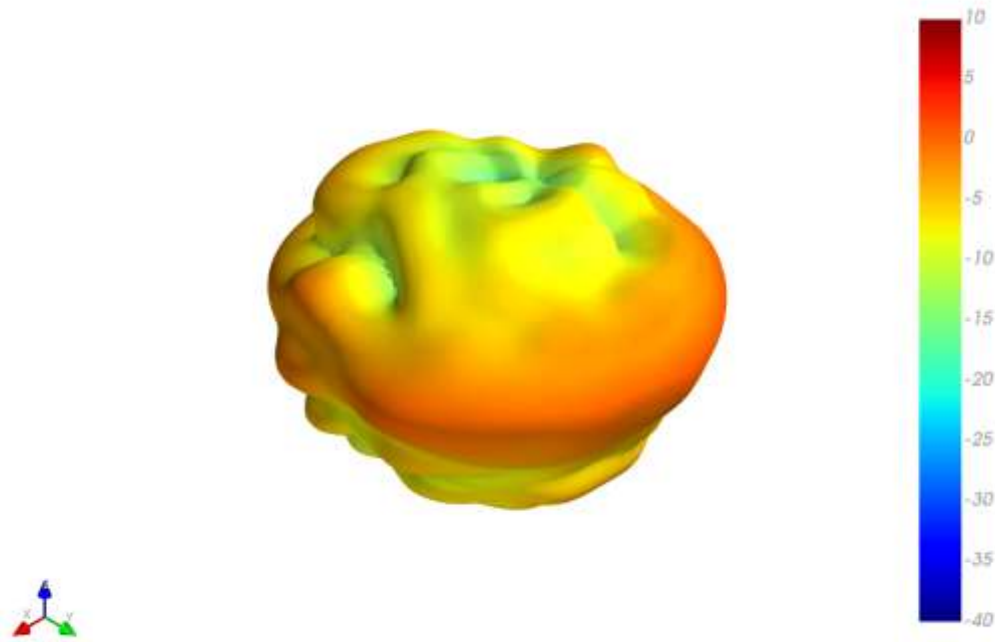

XY Plane XZ Plane YZ Plane

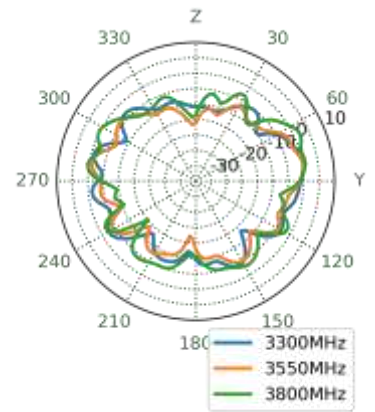
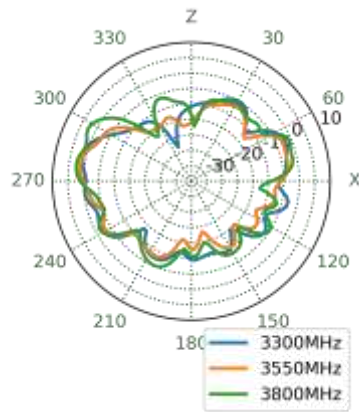
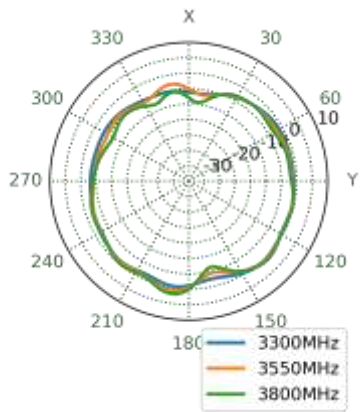

Gain total, 5530MHz

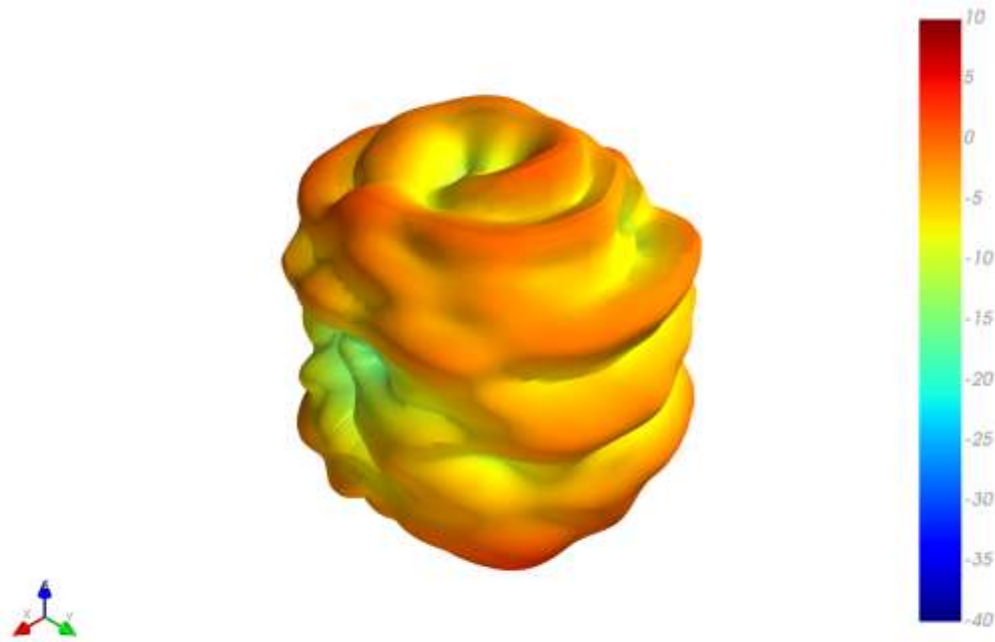

XY Plane XZ Plane YZ Plane

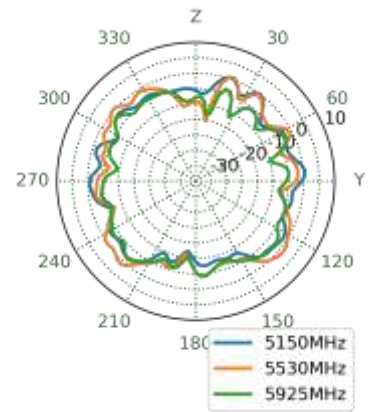
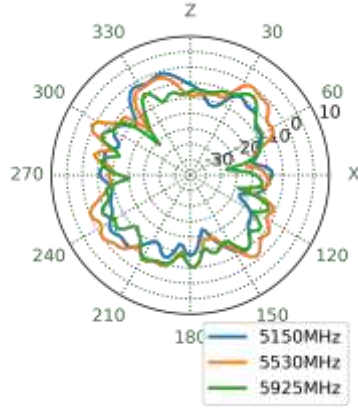
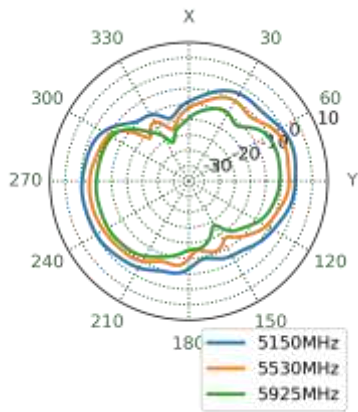

4.4 Bent in Free Space 3D & 2D Radiation Patterns

Gain total, 652MHz

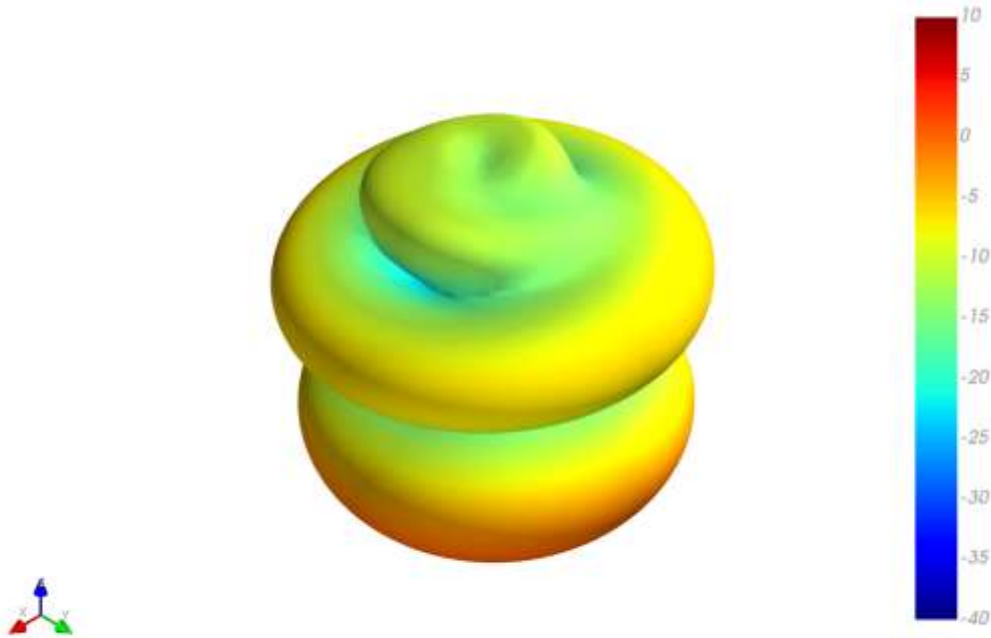

XY Plane XZ Plane YZ Plane

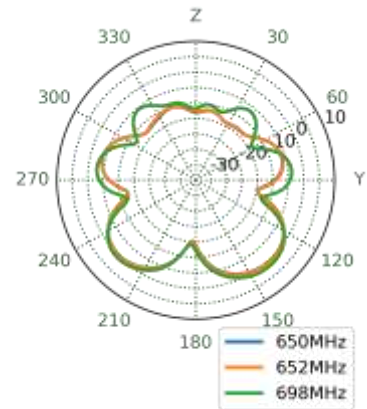
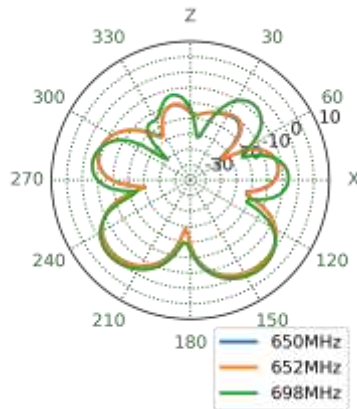
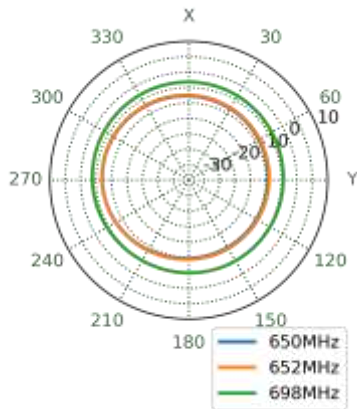

Gain total, 751MHz

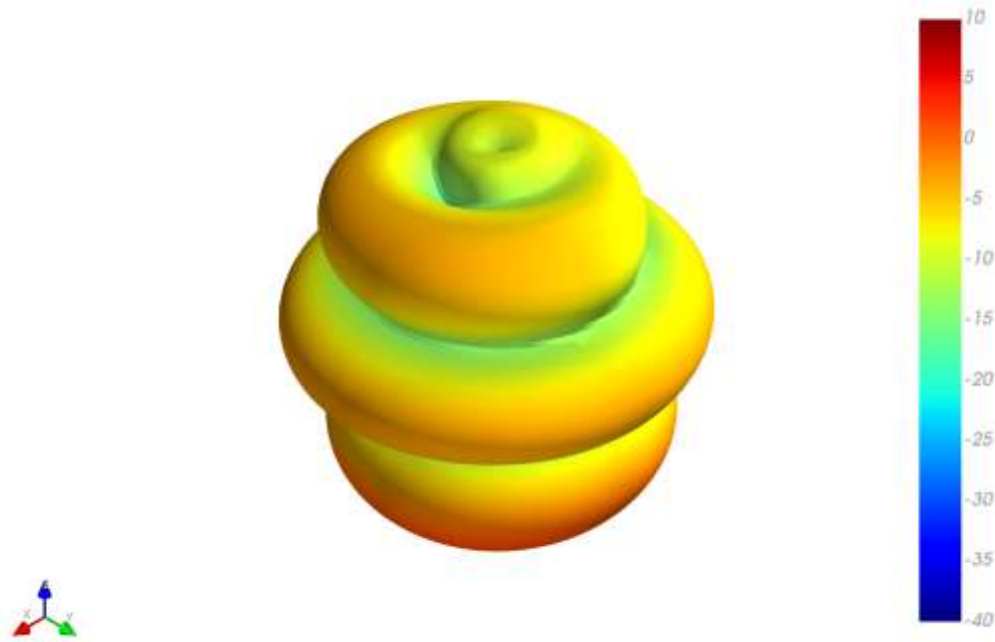

XY Plane XZ Plane YZ Plane

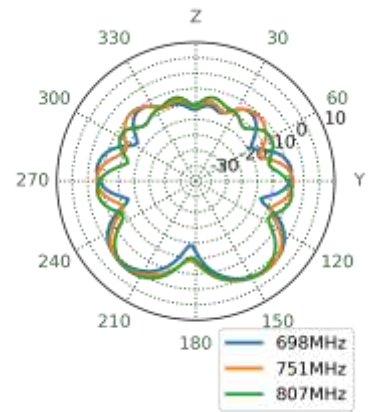
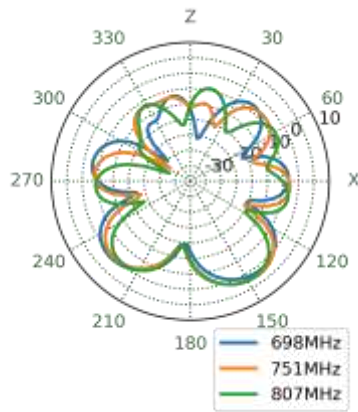
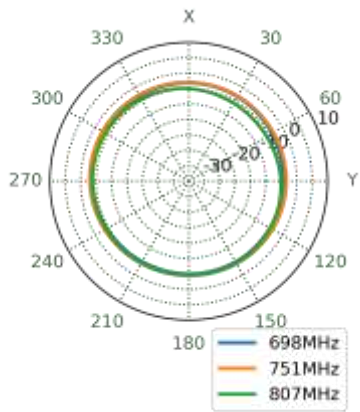

Gain total, 890MHz

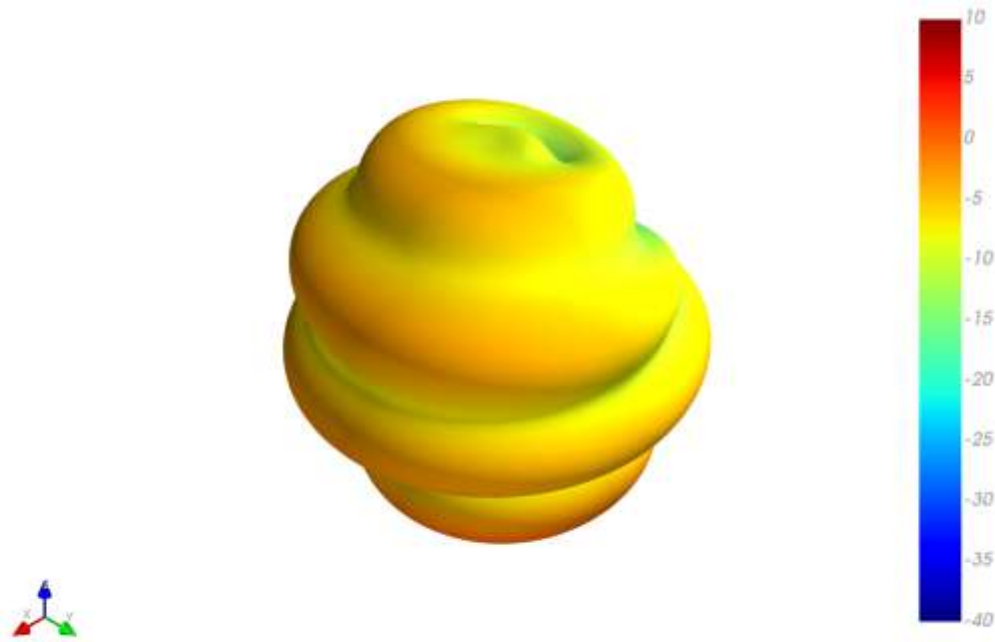

XY Plane XZ Plane YZ Plane

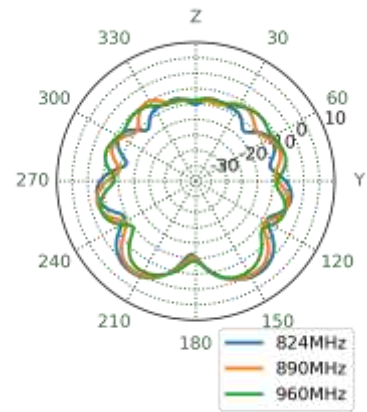
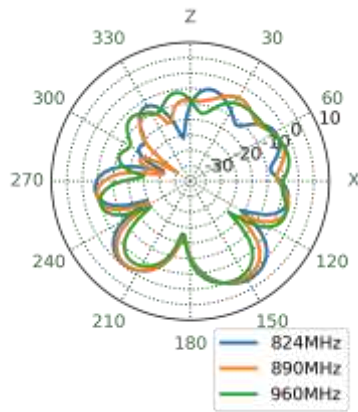
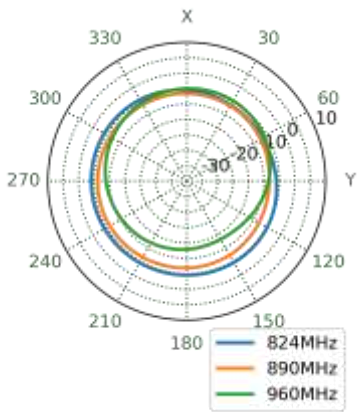

Gain total, 1575MHz

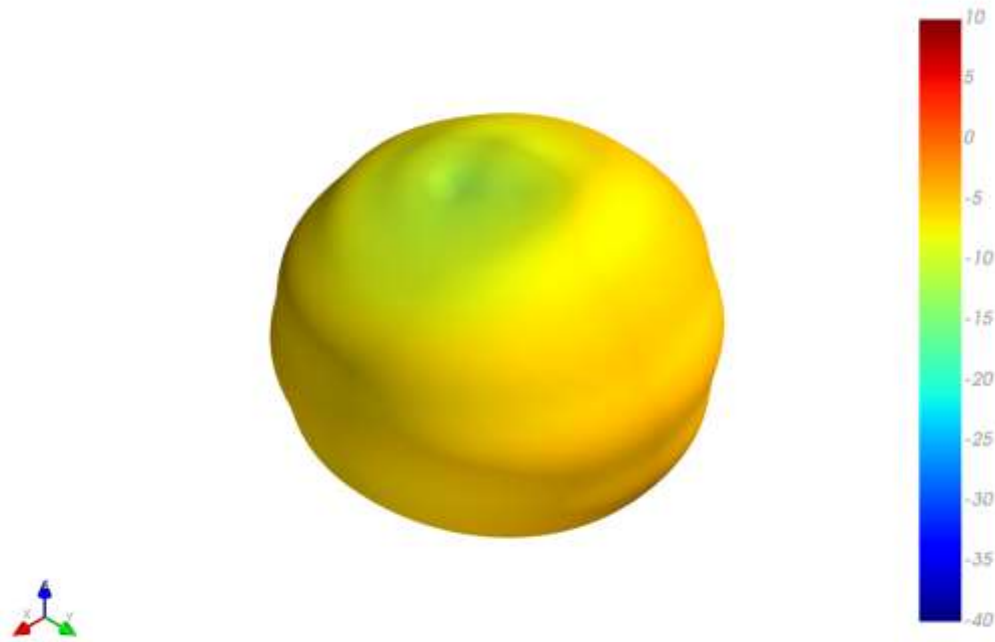

XY Plane XZ Plane YZ Plane

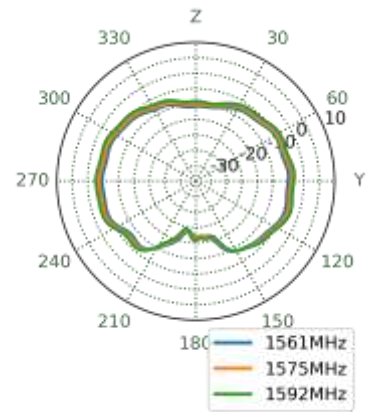
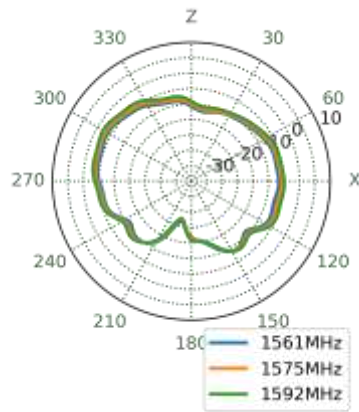
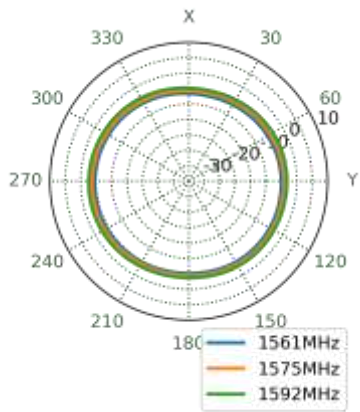

Gain total, 1805MHz

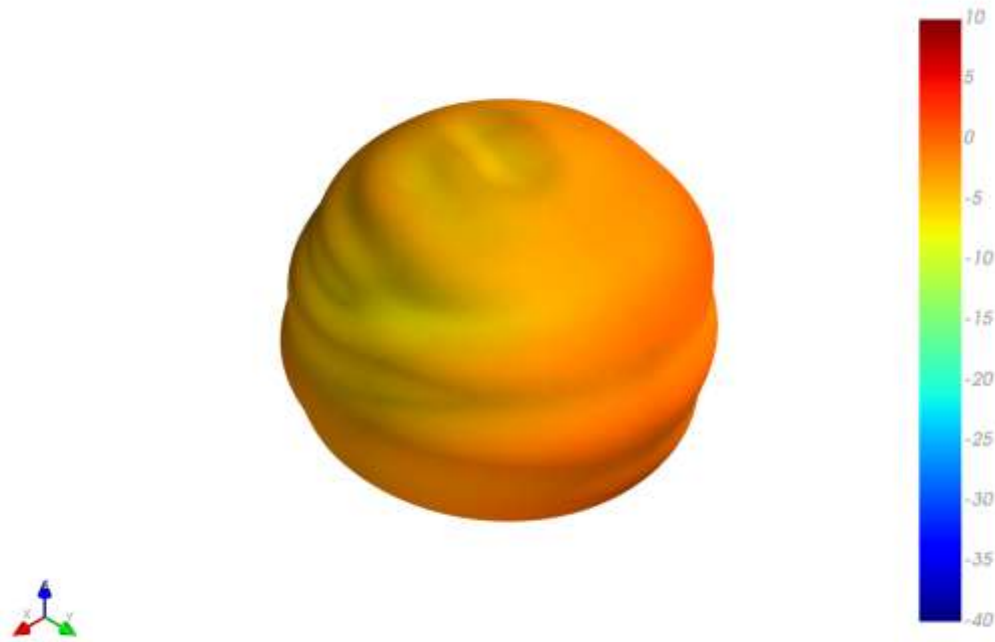

XY Plane XZ Plane YZ Plane

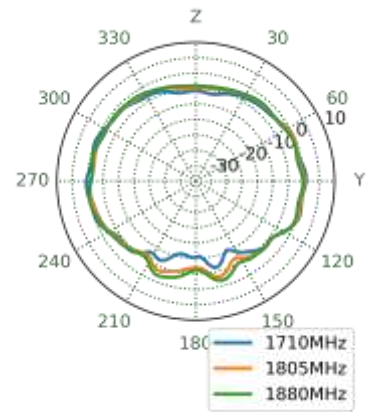
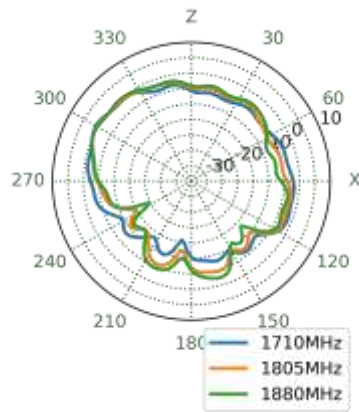
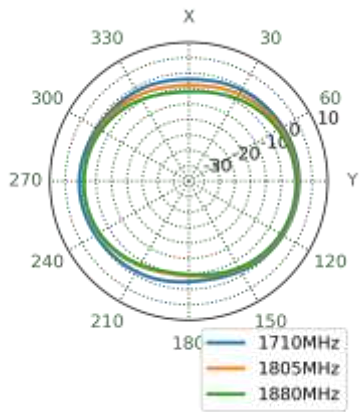

Gain total, 1920MHz

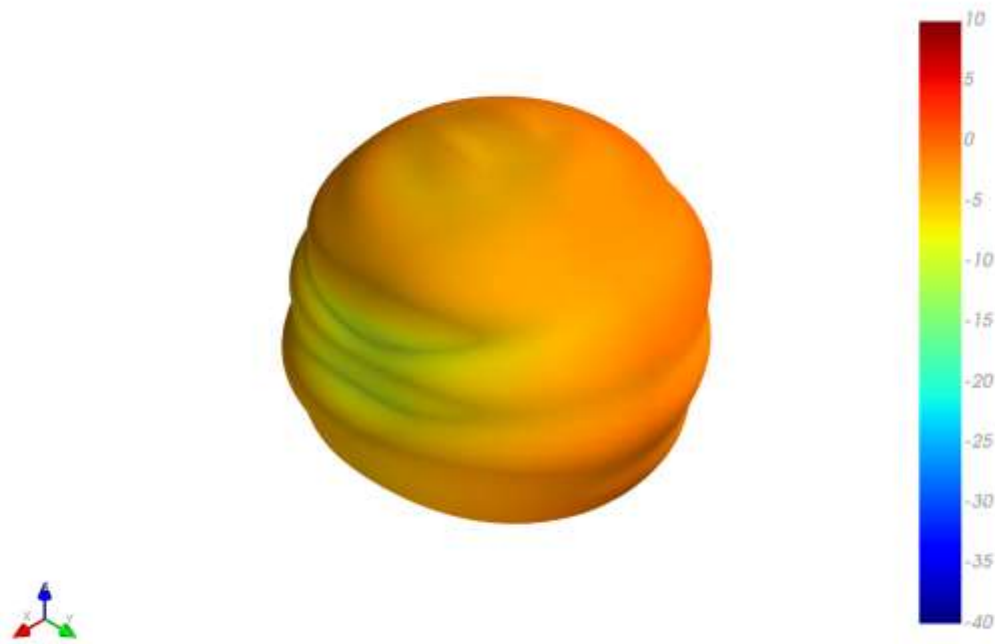

XY Plane XZ Plane YZ Plane

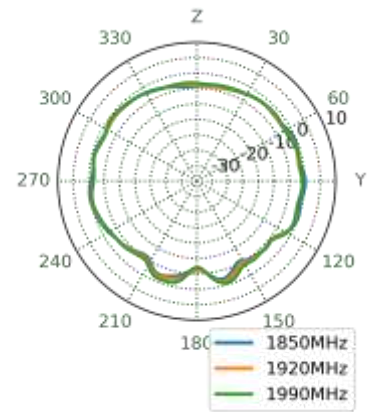
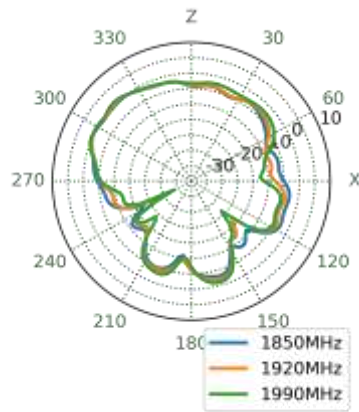
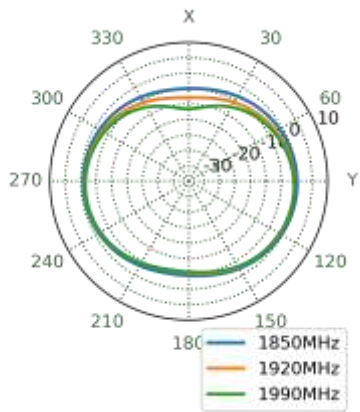

Gain total, 1990MHz

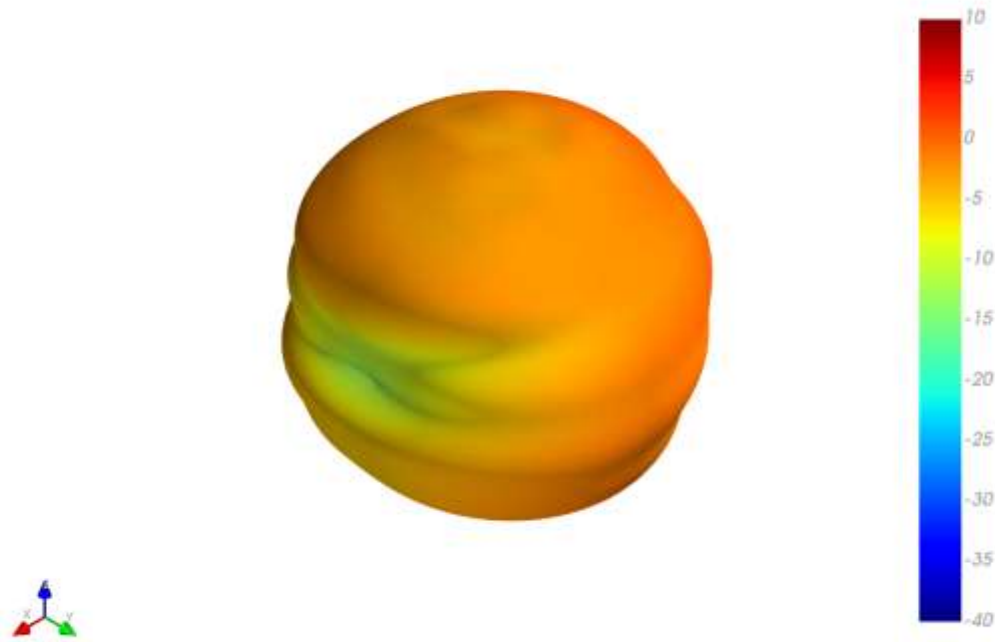

XY Plane

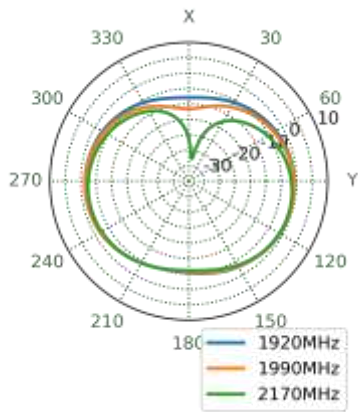

XZ Plane

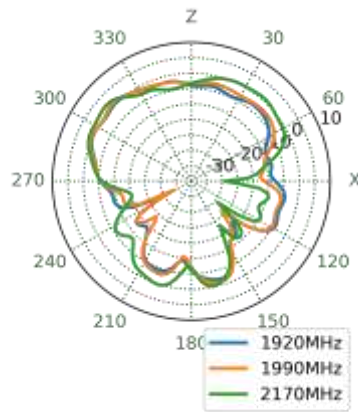

YZ Plane

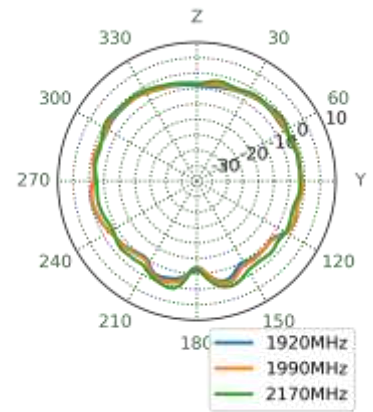

Gain total, 2595MHz

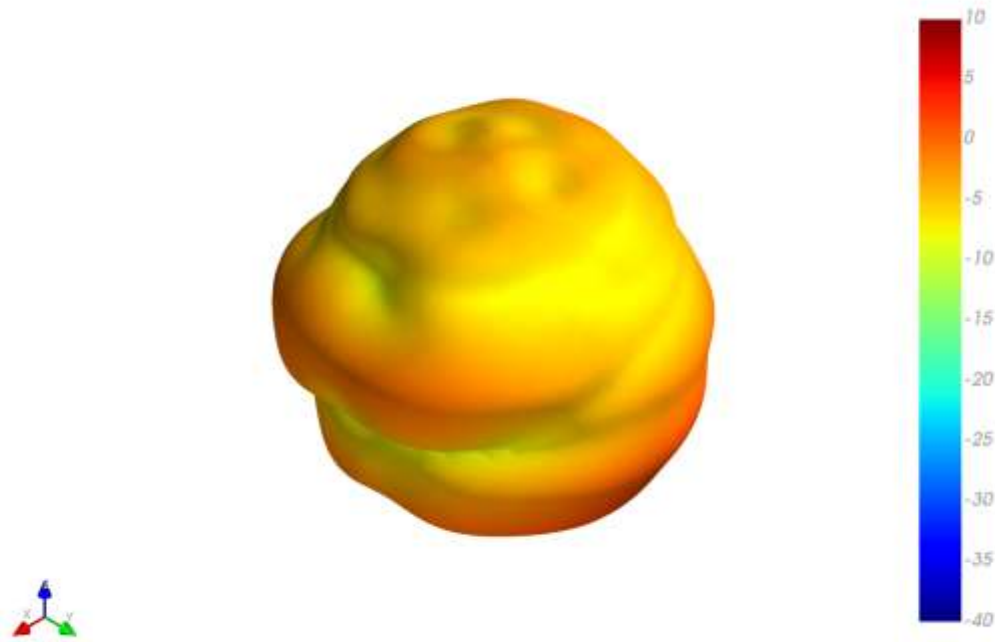

XY Plane XZ Plane YZ Plane

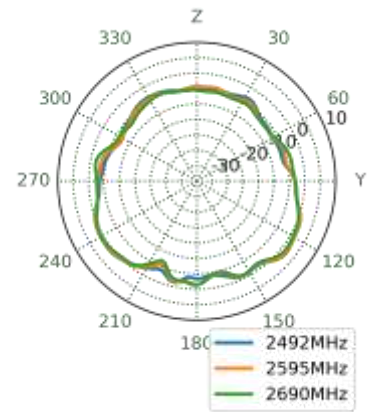
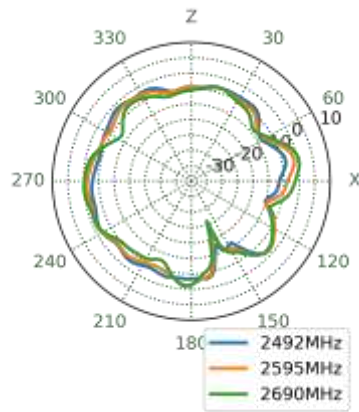
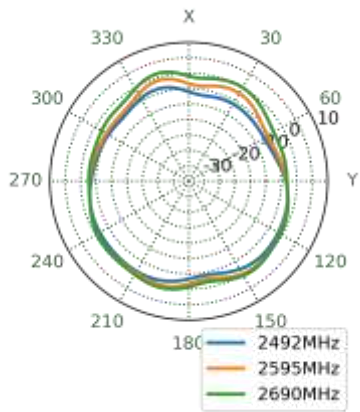

Gain total, 3550MHz

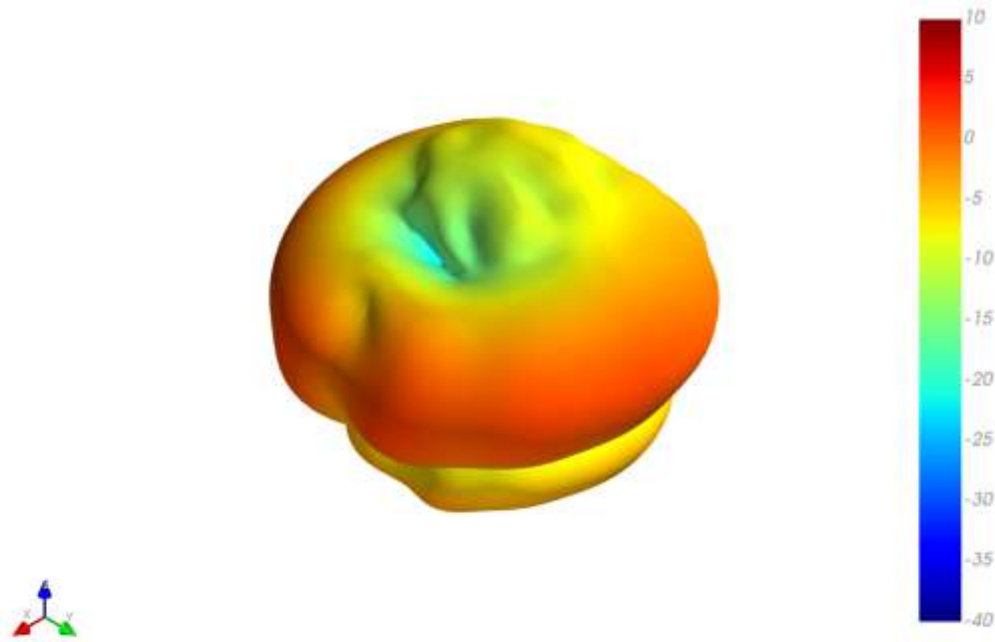

XY Plane XZ Plane YZ Plane

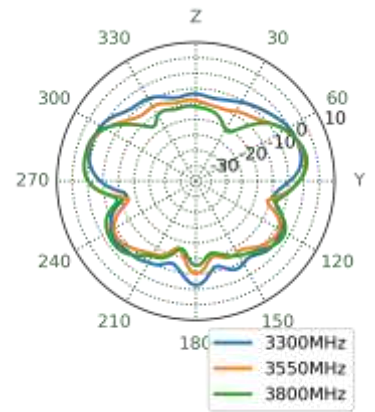
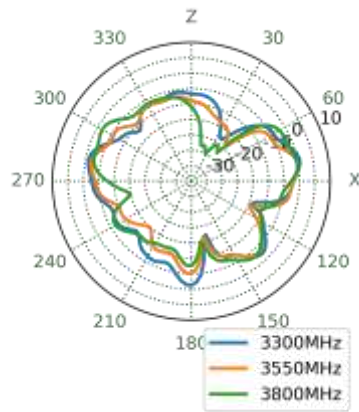
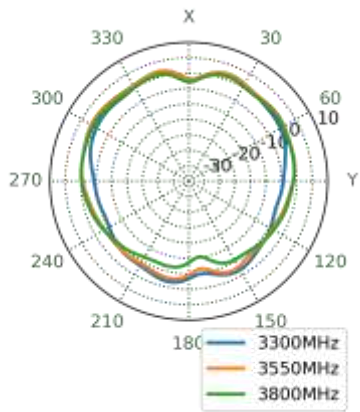

Gain total, 5530MHz

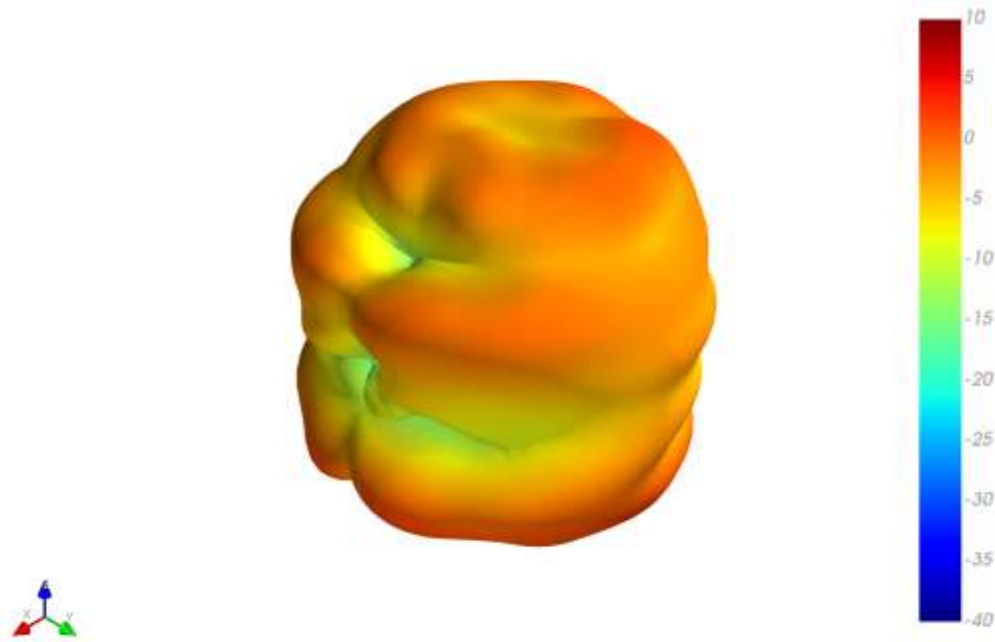

XY Plane XZ Plane YZ Plane

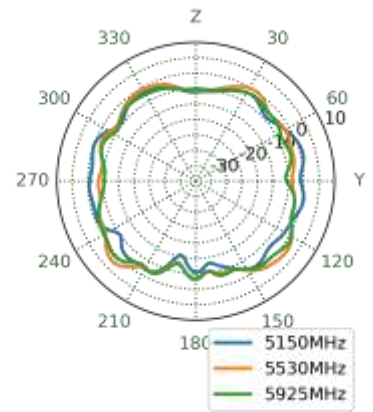
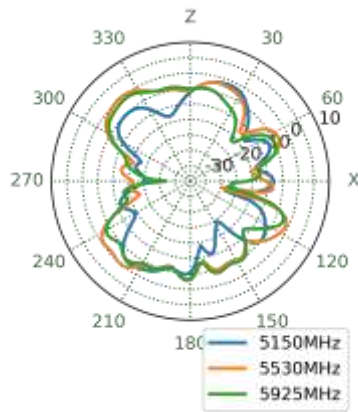
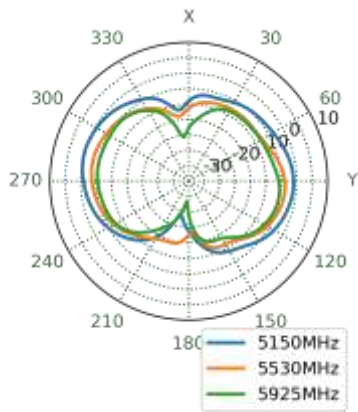

4.5 Straight in Free Space 3D & 2D Radiation Patterns

Gain total, 652MHz

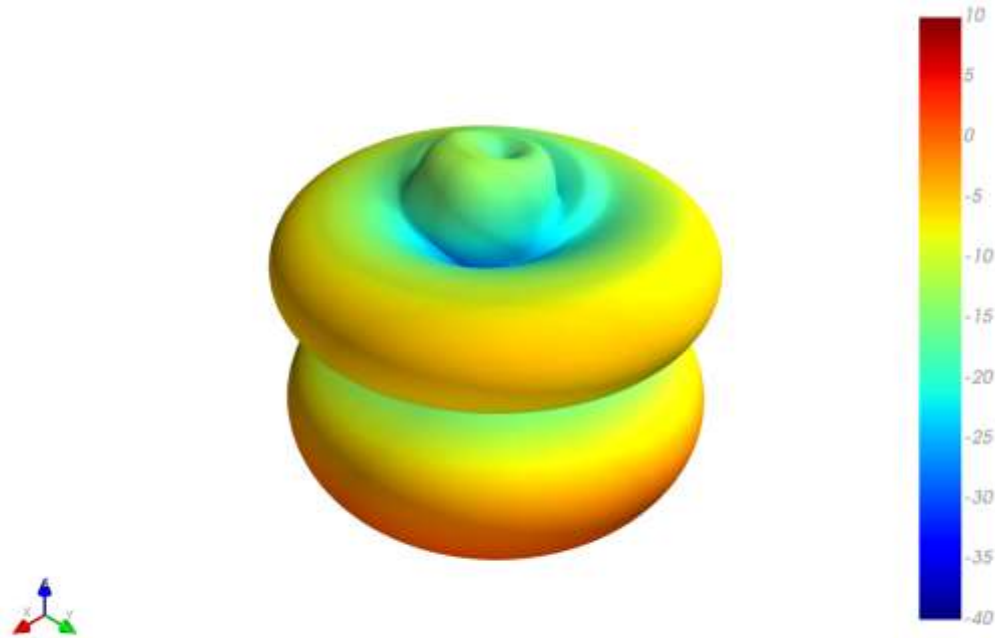

XY Plane

XZ Plane

YZ Plane

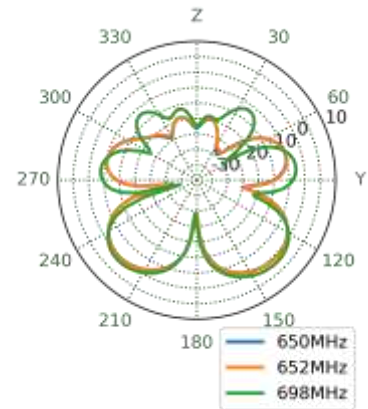
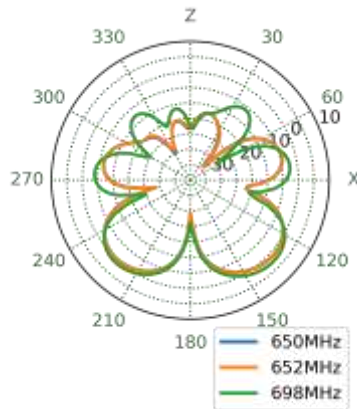
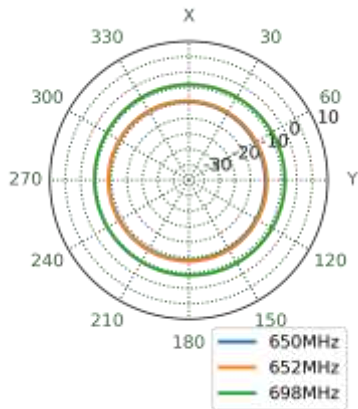

Gain total, 751MHz

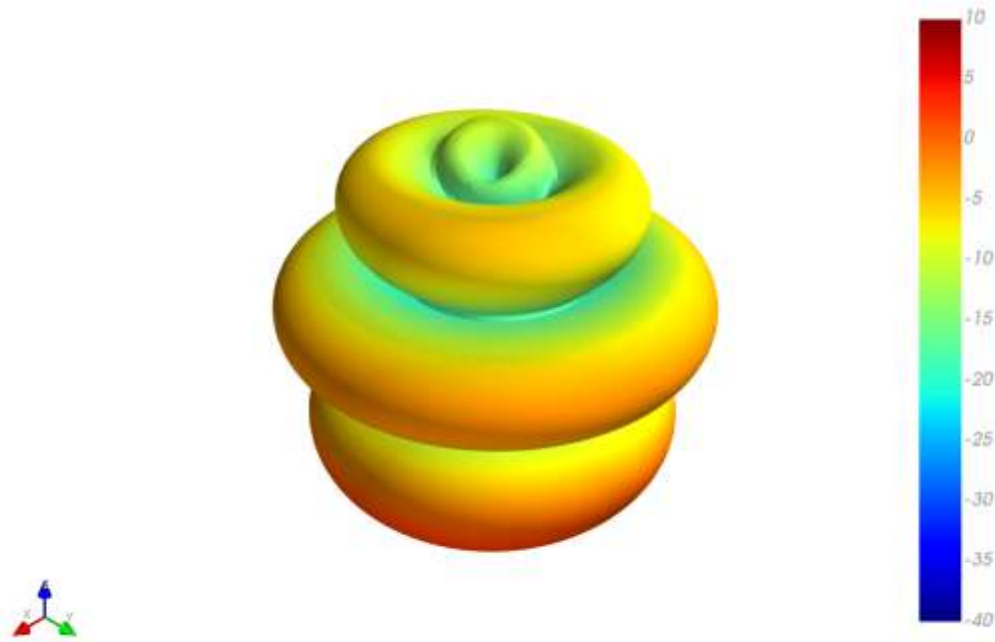

XY Plane XZ Plane YZ Plane

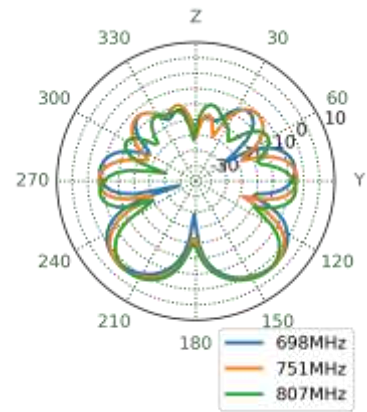
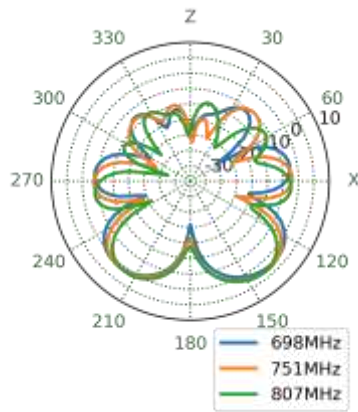
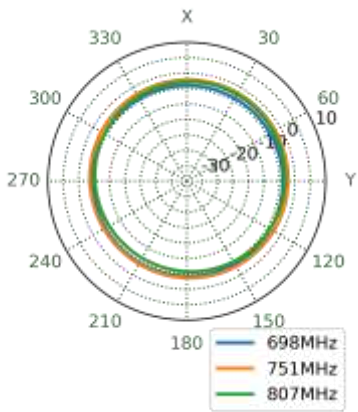

Gain total, 890MHz

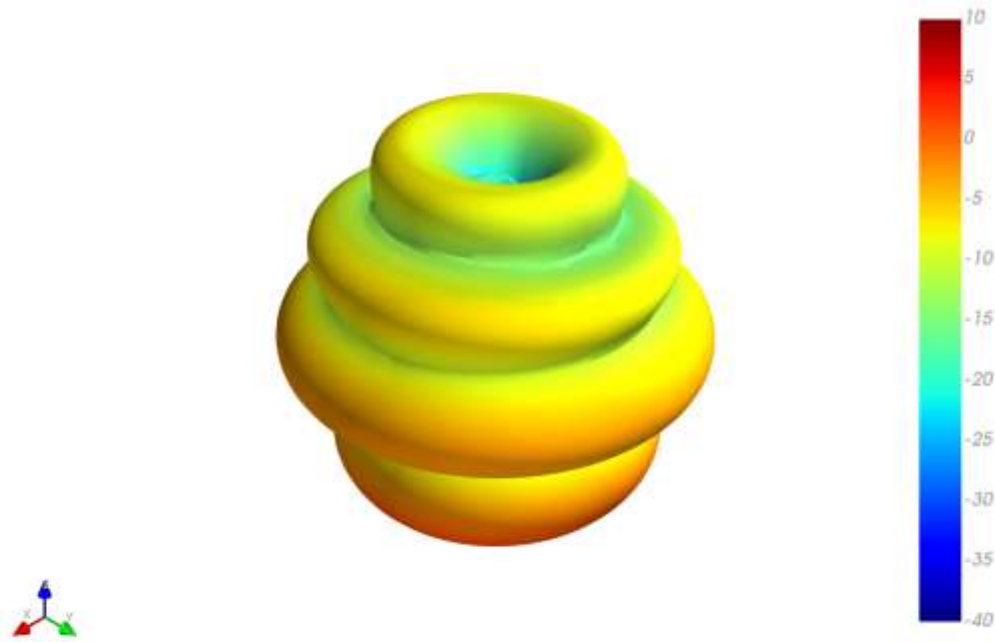

XY Plane XZ Plane YZ Plane

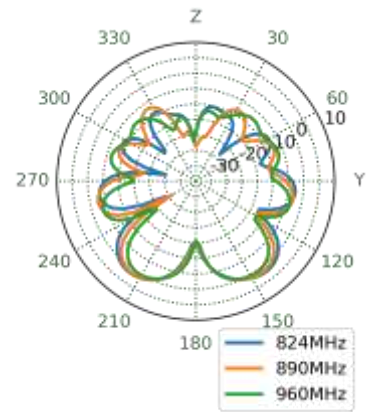
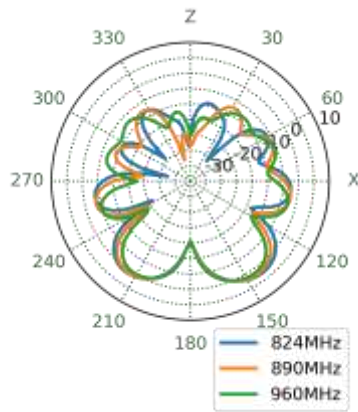
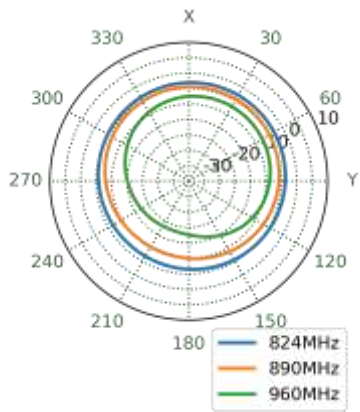

Gain total, 1575MHz

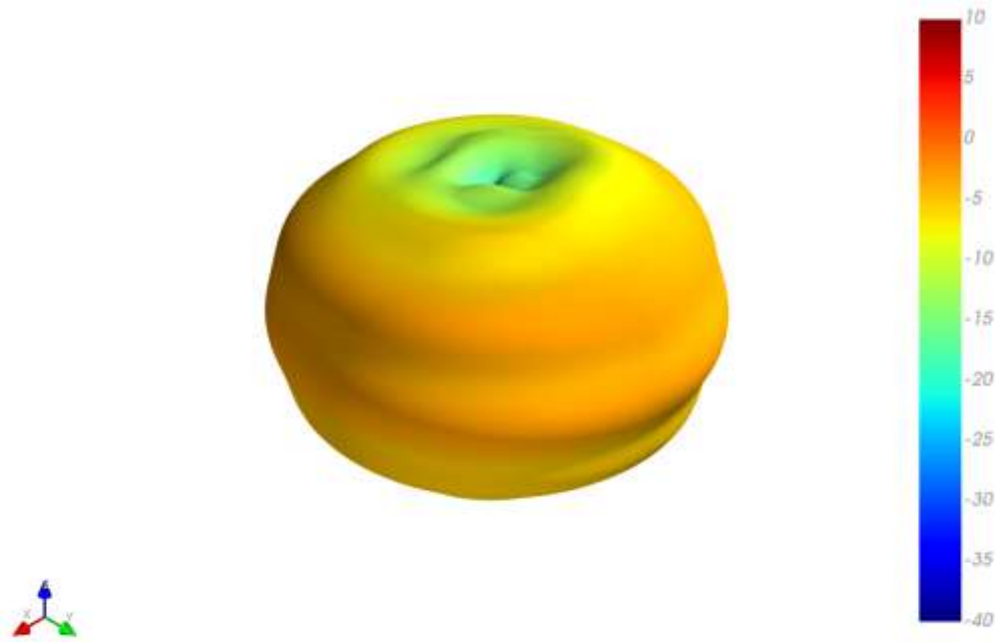

XY Plane XZ Plane YZ Plane

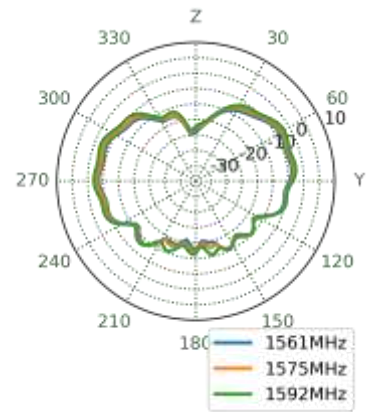
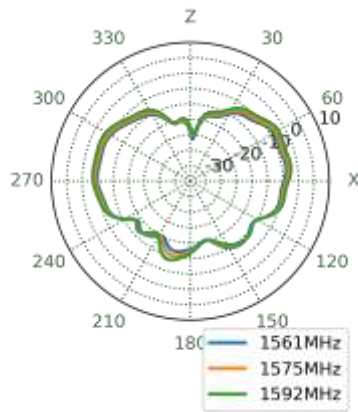
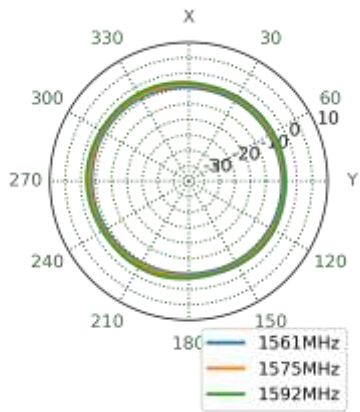

Gain total, 1805MHz

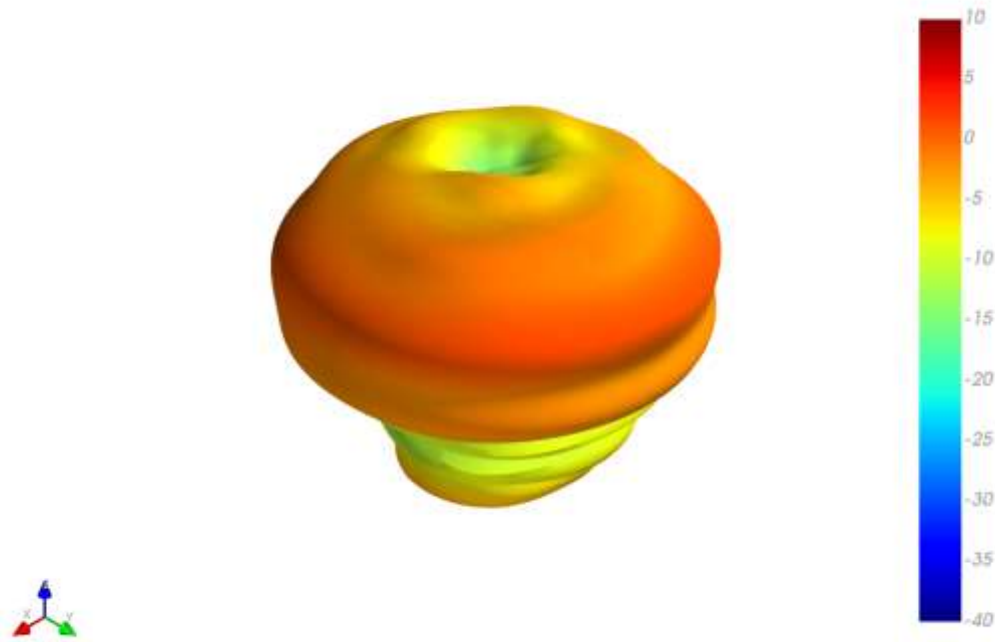

XY Plane XZ Plane YZ Plane

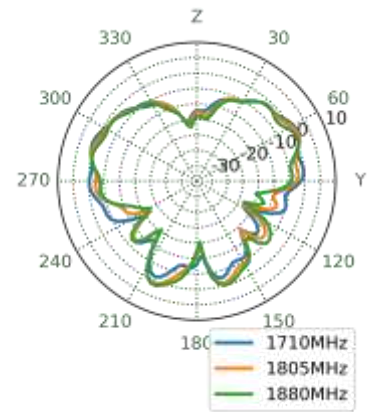
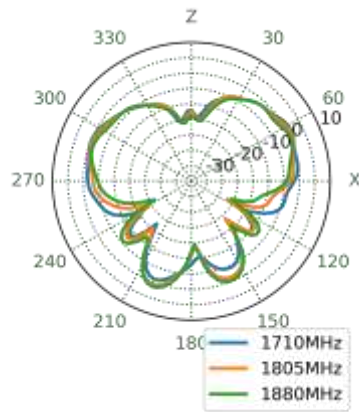
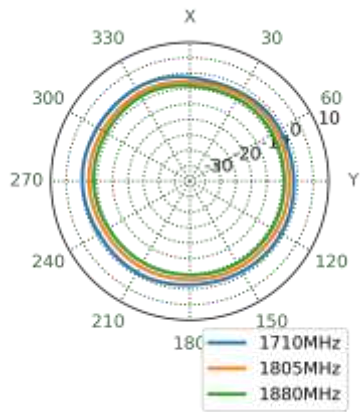

Gain total, 1920MHz

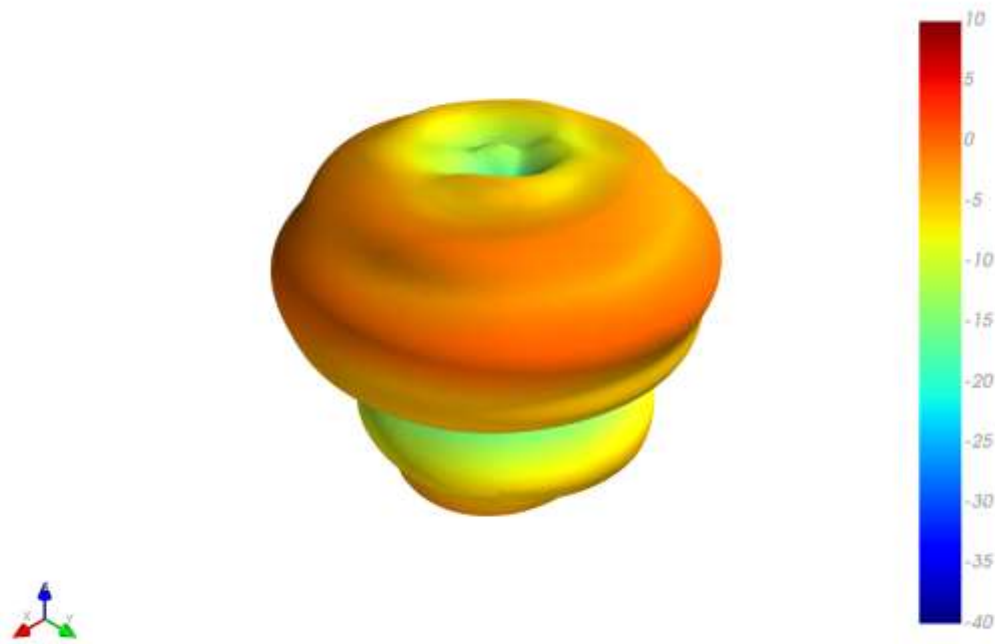

XY Plane XZ Plane YZ Plane

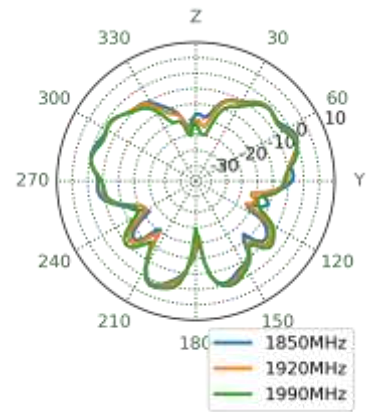
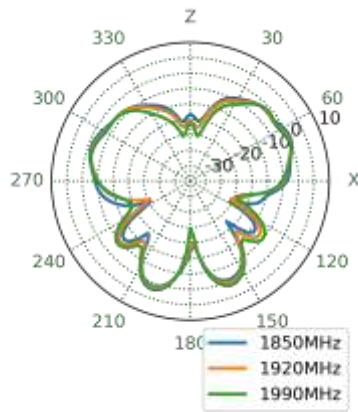
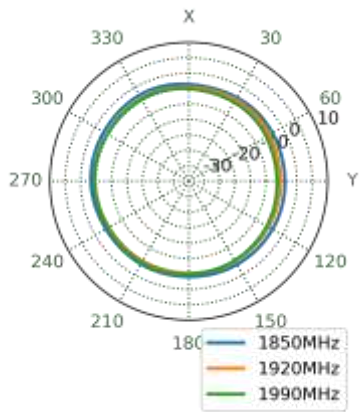

Gain total, 1990MHz

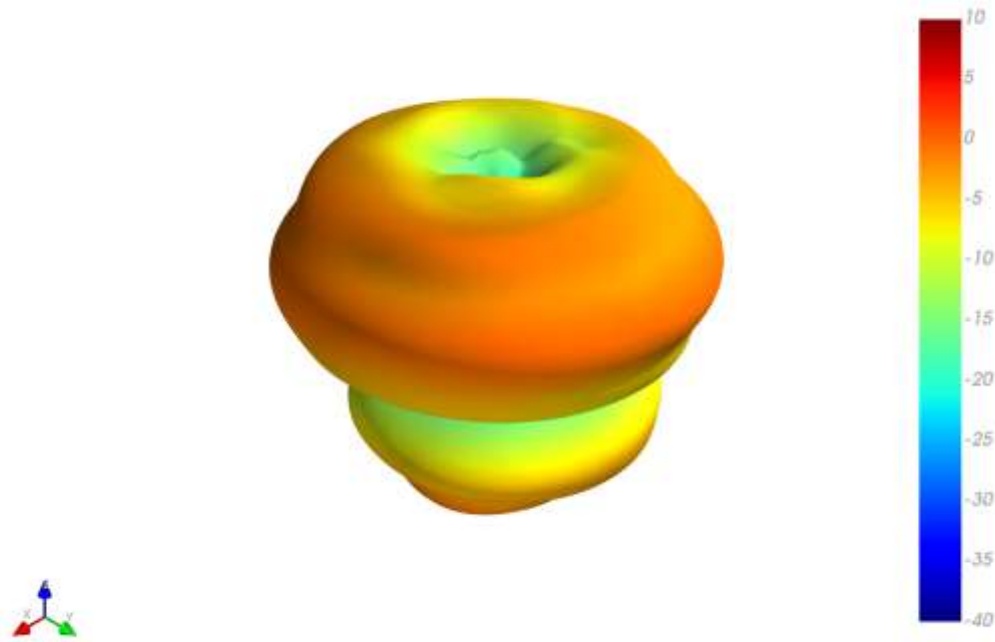

XY Plane XZ Plane YZ Plane

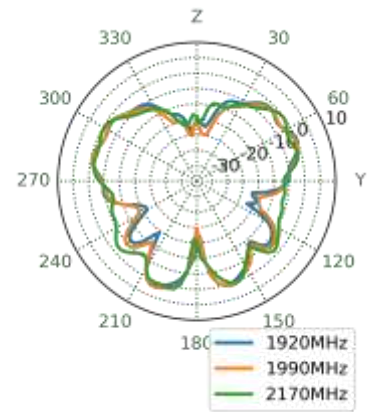
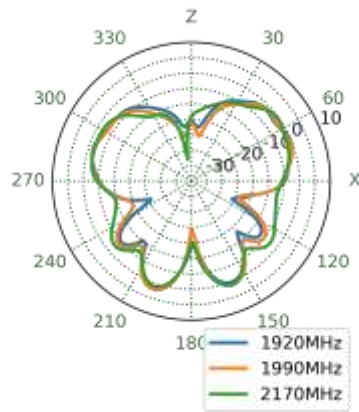
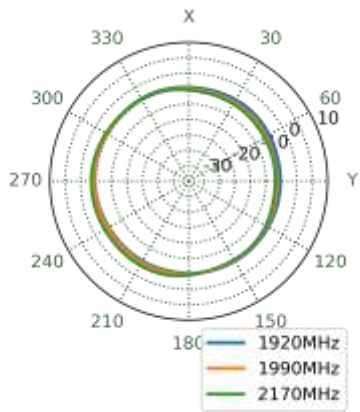

Gain total, 2595MHz

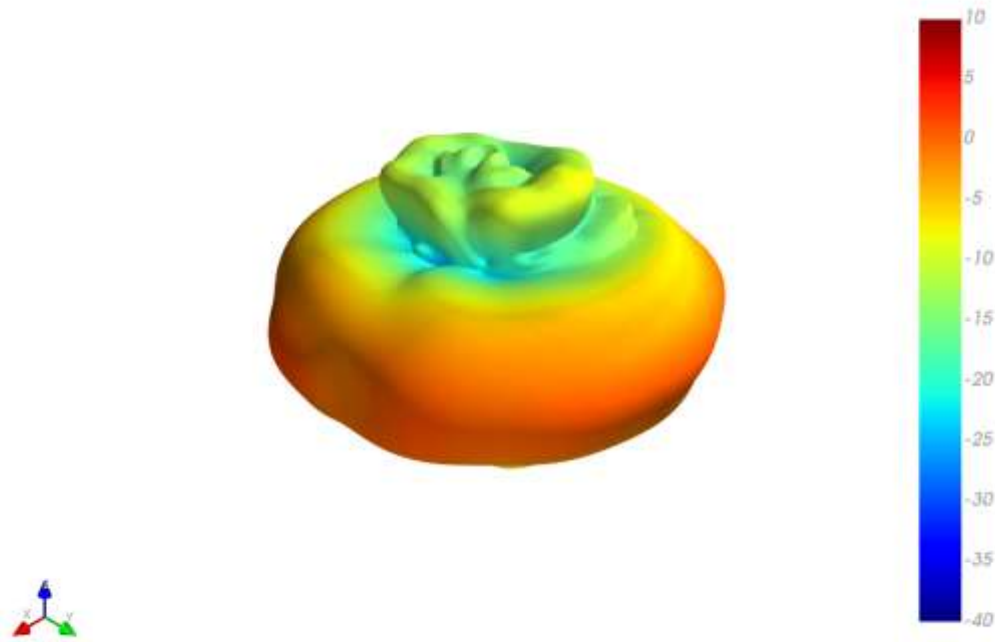

XY Plane XZ Plane YZ Plane

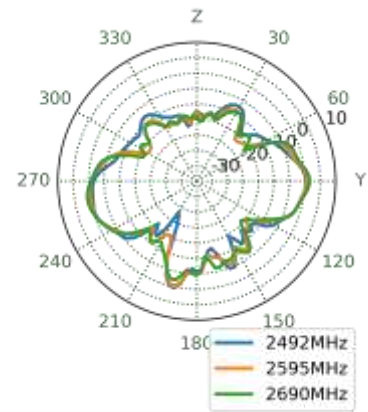
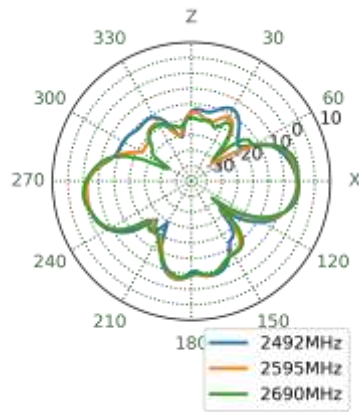
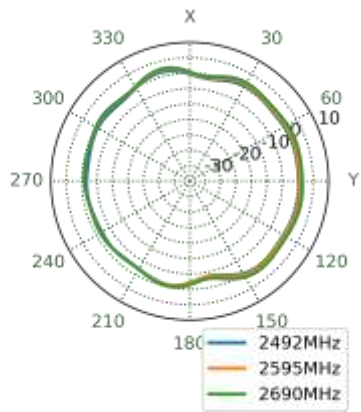

Gain total, 3550MHz

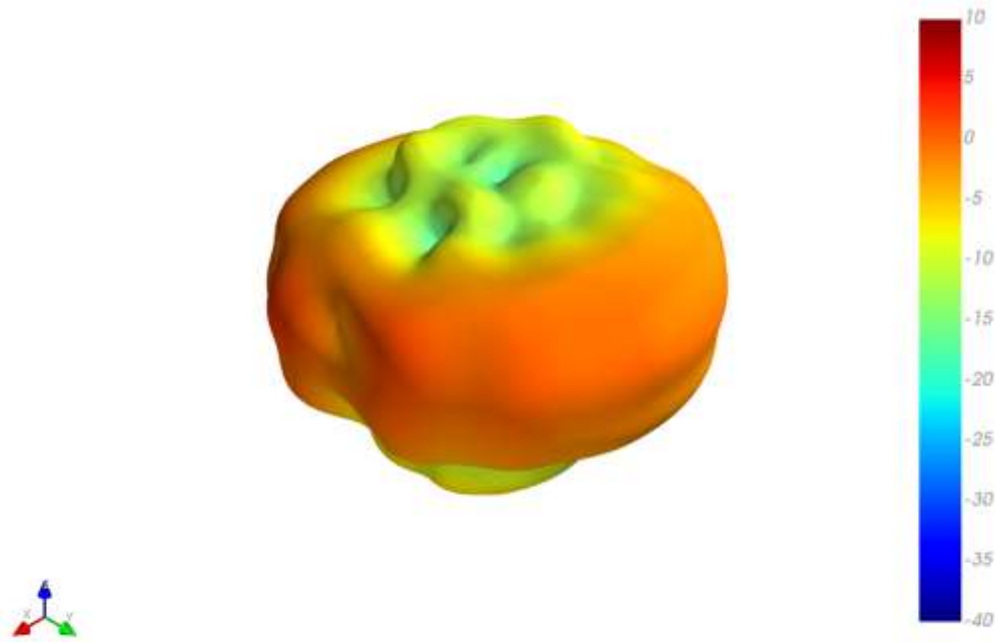

XY Plane XZ Plane YZ Plane

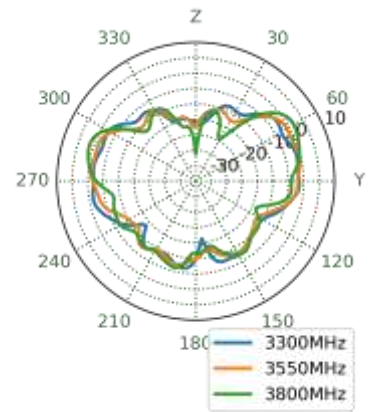
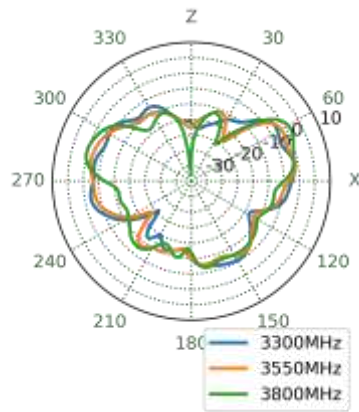
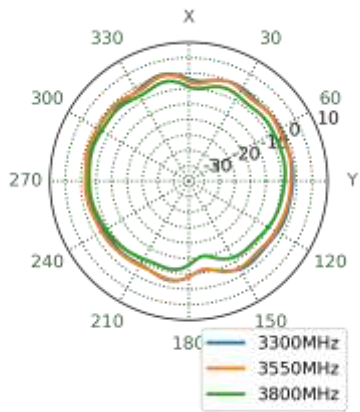

Gain total, 5530MHz

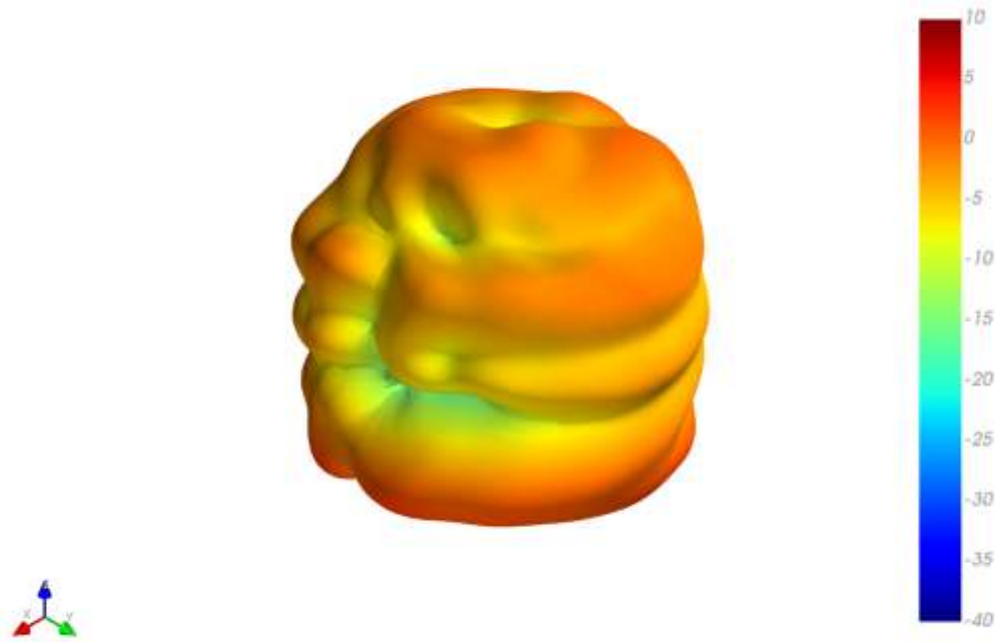

XY Plane XZ Plane YZ Plane

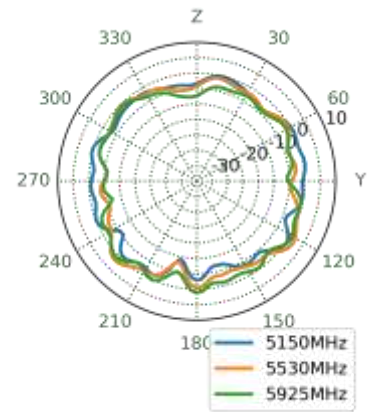
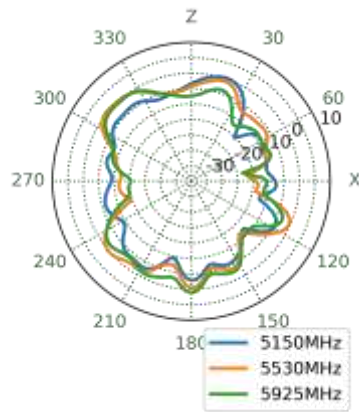
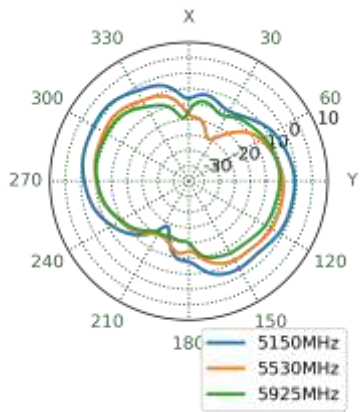

5. Mechanical Drawing (Units: mm)

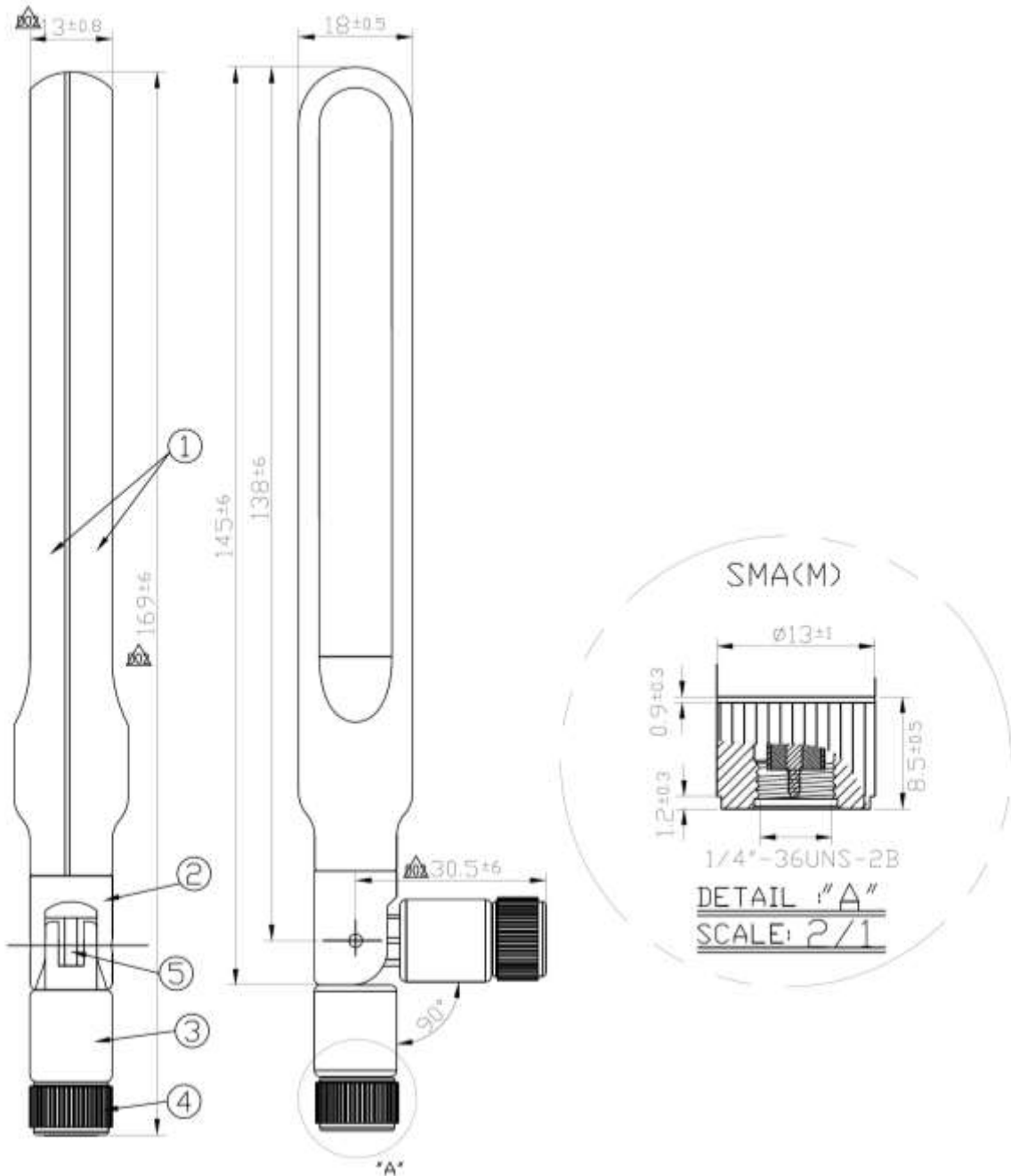

Item	Name	P/N	Material	Finish	QTY
1	TG 10 Antenna Housing	081114020115A	PC+ABS	Black	1
2	TG 10 Antenna Base1	081119280115A	PC+ABS	Black	2
3	TG 10 Antenna Base2	081114280115A	PP	Black	1
4	SMA(M)	21021183010A	Brass	Black	1
5	RG 176 Cable	081114880115A	TCP	Black	1

6. Installation Guide

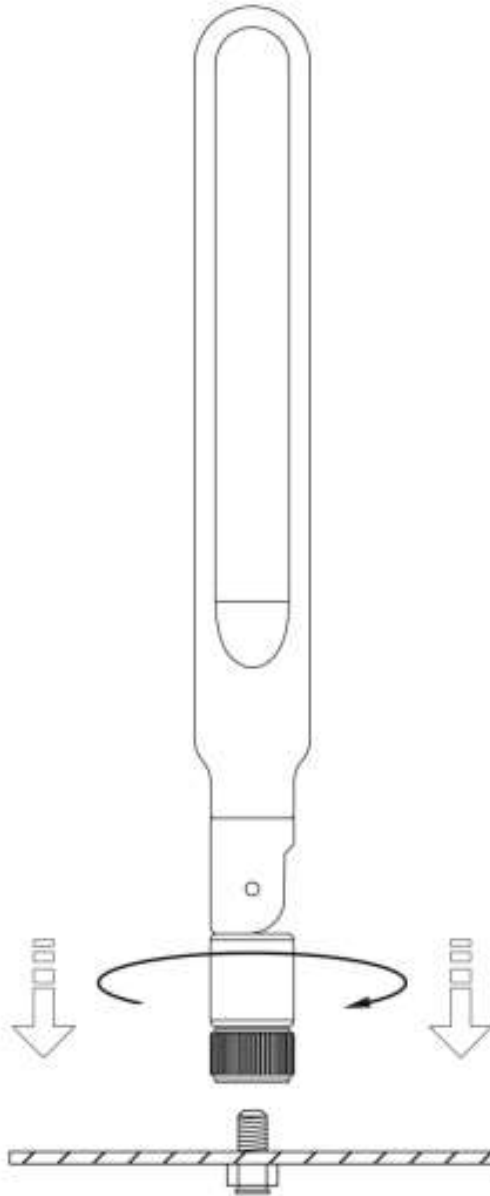

Recommended torque for mounting is 0.9 N·m
 Maximum torque for mounting is 1.176 N·m

7. Packaging

10pc TG.10.0113 per PE Bag
 Bag Dimensions - 260*105mm
 Weight - 0.23Kg



50pc TG.10.0113 per SPQ Bag
 Bag Dimensions - 270*420mm
 Weight - 1.2Kg

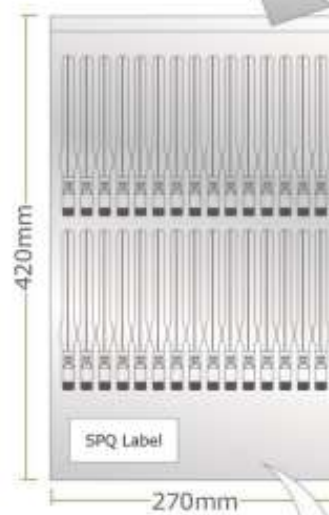

300pcs TG.10.0113 per Carton
 Carton Dimensions - 400*330*220mm
 Weight - 8Kg

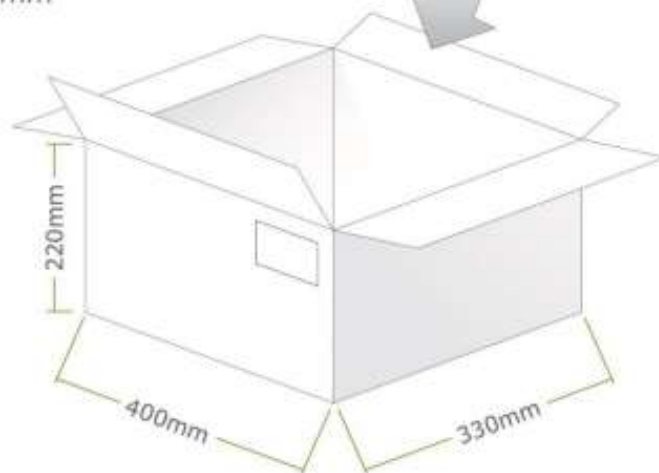

Changelog for the datasheet

SPE-11-8-147 - TG.10.0113

Revision: J (Current Version)

Date:	2022-02-28
Changes:	Updated intro
Changes Made by:	Gary West

Previous Revisions

Revision: I

Date:	2021-11-26
Changes:	Updated datasheet template & data.
Changes Made by:	Gary West

Revision: D

Date:	2013-10-17
Changes:	Amended dimensions
Changes Made by:	Aine Doyle

Revision: H

Date:	2018-11-30
Changes:	Added VSWR Tables
Changes Made by:	Jack Conroy

Revision: C

Date:	2012-02-02
Changes:	
Changes Made by:	

Revision: G

Date:	
Changes:	
Changes Made by:	

Revision: B

Date:	2011-12-15
Changes:	
Changes Made by:	

Revision: F

Date:	2017-04-04
Changes:	
Changes Made by:	

Revision: A (Original First Release)

Date:	2011-12-09
Notes:	
Author:	

Revision: E

Date:	2014-10-17
Changes:	Updated performance
Changes Made by:	Aine Doyle



TAOGLAS®

www.taoglas.com