

B450, Tantalum, MnO2 Tantalum, 10 uF, 20%, 35 V, SMD, Molded, Low ESR, Surge Robust, 130 mOhms, 7343, Height Max = 3.1mm

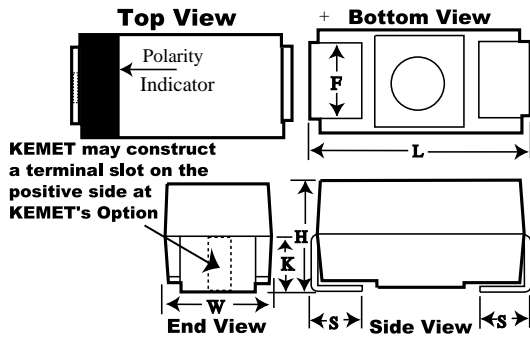

General Information	
Supplier:	KEMET
Series:	B450
Dielectric:	MnO2 Tantalum
Style:	SMD Chip
Description:	SMD, Molded, Low ESR, Surge Robust
Features:	Low ESR, Surge Robust
RoHS:	Yes
Termination:	Tin
Notes:	Obsolete. Old Part Number [Obsolete] Was B45035D1069M137

Dimensions	
Footprint	7343
L	7.3mm +/-0.3mm
W	4.3mm +/-0.3mm
H	2.8mm +/-0.3mm
S	1.3mm +/-0.3mm
F	2.4mm +/-0.1mm
K	1.8mm TYP

Packaging Specifications	
Packaging:	T&R, 178mm
Packaging Quantity:	750

Specifications	
Capacitance:	10 uF
Capacitance Tolerance:	20%
Voltage DC:	35 VDC (85C), 23.45 VDC (125C)
Temperature Range:	-55/+125C
Rated Temperature:	85C
Dissipation Factor:	6%
Failure Rate:	N/A
Resistance:	0.13 Ohms (100kHz)
Current:	1070 mAmps (25C), 963 mAmps (85C), 428 mAmps (125C)
Leakage Current:	3.5 uA