

## Si4825 DEMO BOARD USER'S GUIDE

### 1. Features

- ATAD (analog tune and analog display) AM/FM/SW radio
- Worldwide FM band support 64–109 MHz with 18 bands, see the Table 1
- Worldwide AM band support 504–1750 kHz with 5 bands, see the Table 1
- Worldwide SW band support 2.3–28.5 MHz with 18 wide bands or 18 narrow bands, see the Table 1
- Twelve positions band switch for selecting different band according to the target market
- Two AAA battery operations with working voltage down to 2.0 V
- Economical potentiometer for frequency tuning replaces more expensive variable capacitor (PVC)
- Potentiometer and/or push button volume control
- FM 50  $\mu$ s or 75  $\mu$ s de-emphasis
- SW Wide/Narrow-band selection via a slide switch

**Table 1. Si4825 Band Sequence Definition**

Band Name	Band Frequency Range	De-emphasis (FM) Channel Space (AM)	Note
FM1	87–108 MHz	50 $\mu$ s	
FM2	87–108 MHz	50 $\mu$ s	
FM3	87–108 MHz	75 $\mu$ s	Demo Board Default
FM4	87–108 MHz	75 $\mu$ s	
FM5	86.5–109 MHz	50 $\mu$ s	
FM6	86.5–109 MHz	50 $\mu$ s	
FM7	87.3–108.25 MHz	50 $\mu$ s	
FM8	87.3–108.25 MHz	50 $\mu$ s	
FM9	87.3–108.25 MHz	75 $\mu$ s	
FM10	87.3–108.25 MHz	75 $\mu$ s	
FM11	76–90 MHz	50 $\mu$ s	
FM12	76–90 MHz	50 $\mu$ s	
FM13	64–87 MHz	50 $\mu$ s	
FM14	64–87 MHz	50 $\mu$ s	
FM15	76–108 MHz	50 $\mu$ s	
FM16	76–108 MHz	50 $\mu$ s	

# Si4825-DEMO

**Table 1. Si4825 Band Sequence Definition (Continued)**

Band Name	Band Frequency Range		De-emphasis (FM) Channel Space (AM)	Note
FM17	64–108 MHz		50 $\mu$ s	Demo Board Default
FM18	64–108 MHz		50 $\mu$ s	
AM1	520–1710 kHz		10k	Demo Board Default
AM2	522-1620 kHz		9k	Demo Board Default
AM3	504-1665 kHz		9k	
AM4	522-1728 kHz / 520-1730 kHz		9k / 10k	
AM5	510-1750 kHz		10k	
SW1	SW Wide Band	SW Narrow Band		
	2.3–10.0 MHz	2.30–2.49 MHz		
SW2	3.2–7.6 MHz	3.20–3.40 MHz		Demo Board Default
SW3	3.2–10.0 MHz	3.90–4.00 MHz		Demo Board Default
SW4	3.7–12.5 MHz	4.75–5.06 MHz		
SW5	3.9–7.5 MHz	5.6 –6.4 MHz		
SW6	5.6–22 MHz	5.95– 6.2 MHz		
SW7	5.8–12.1 MHz	6.8–7.6 MHz		
SW8	5.9–9.50 MHz	7.1–7.6 MHz		
SW9	5.9–18.0 MHz	9.2–10 MHz		Demo Board Default
SW10	7.0–16.0 MHz	11.45–12.25 MHz		Demo Board Default
SW11	7.0–23.0 MHz	11.6–12.2 MHz		Demo Board Default
SW12	9.0–16.0 MHz	13.4–14.2 MHz		
SW13	9.0–22.0 MHz	13.57–13.87 MHz		Demo Board Default
SW14	9.5–18.0 MHz	15 –15.9 MHz		Demo Board Default
SW15	10.0–16.0 MHz	17.1 –18 MHz		
SW16	10.0–22.0 MHz	17.48–17.9 MHz		Demo Board Default
SW17	13.0–18.0 MHz	21.2–22 MHz		
SW18	18.0–28.5 MHz	21.45 –21.85 MHz		

## 2. Overview

This manual describes the operation of the Skyworks Solutions Si4825-DEMO board Rev1.1, November 20, 2012. The Skyworks Solutions Si4825-DEMO board is designed with the 16-pin SOIC packaged Si4825 chip, the revolutionary single chip AM/FM/SW receiver that integrates everything from antenna input to audio output and allows use of common and economical potentiometers to do the frequency tuning. It provides a complete portable analog tune analog display AM/FM/SW radio design. The Si4825-DEMO is designed with 1-layer PCB, allowing the lowest cost without sacrificing the RF performance. The demo board works with two AAA batteries and working voltage down to 2.0 V.

## 3. Description

Figure 1 and Figure 2 shows the physical layout of the board with key components indicated.

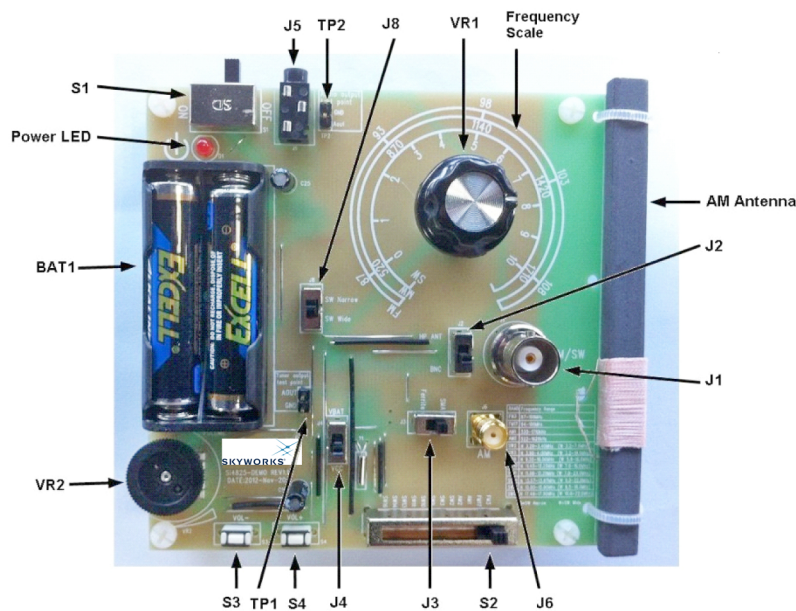

Figure 1. Si4825-DEMO Board Top Side

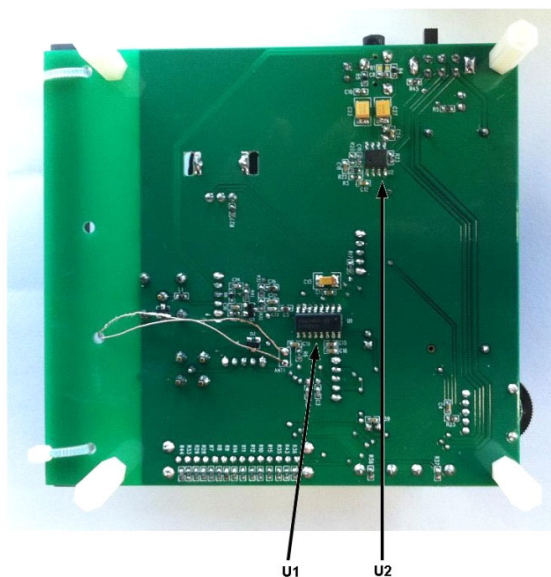

Figure 2. Si4825-DEMO Board Bottom Side

# Si4825-DEMO

---

## Power:

BAT1: 2 cells AAA battery holder

S1: Power on / off

## Audio Connectors:

J5: Mono audio headphone output

## Antenna Selections:

AM antenna: Ferrite stick antenna for AM

J1: BNC connector for FM/ SW conductive testing or FM whip antenna

J2: FM antenna selector

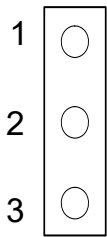

1-2: HP ANT (J5)

2-3: BNC (J1)

J6: SMA connector for AM conductive testing

J3: AM antenna selector

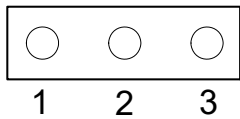

1-2: AM Ferrite Antenna

2-3: SMA (J6)

## Audio Output Test Point:

For the general specification test, TP2 is the recommended audio signal test point. The audio test instrument should be connected to TP2 to get more accurate test results. J5 can also be used as an audio test point, but the test results may not be entirely accurate under some circumstances.

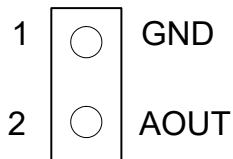

## Tuner Output Test Point:

For the tuner specification test, TP1 is the recommended tuner output test point. The audio test instrument should be connected to TP1 to get accurate test results.

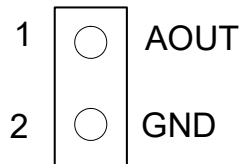

## Main Components:

U1: Skyworks Solutions Si4825 AM/FM/SW ATAD receiver

U2: Audio amplifier

Frequency scale: The analog display for tuning frequency

## Control Interface:

VR1: Frequency tuning wheel.

VR2: Volume control wheel

S3,S4: The push buttons for volume control

J4: Tuner VDD connector (connect tuner Pin14 VDD to VBAT or VCC)

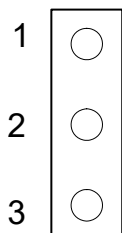

1-2: VBAT

2-3: VCC

J8: SW Wide/Narrow-band selector

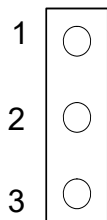

1-2: SW Narrow-band

2-3: SW Wideband

# Si4825-DEMO

---

S2: Band switch for FM, AM and SW

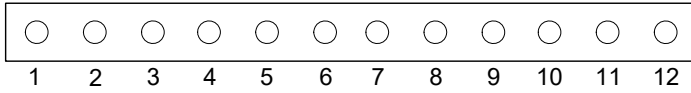

- 1: FM3 (87–108 MHz)
- 2: FM17 (64–108 MHz)
- 3: AM1 (520–1710 kHz)
- 4: AM2 (522–1620 kHz)
- 5: SW2 (N 3.2–3.4 MHz) (W 3.2–7.6 MHz)
- 6: SW3 (N 3.9–4.0 MHz) (W 3.2–10.0 MHz)
- 7: SW9 (N 9.2–10.0 MHz) (W 5.9–18.0 MHz)
- 8: SW10 (N 11.45–12.25 MHz) (W 7.0–16.0 MHz)
- 9: SW11 (N 11.6–12.2 MHz) (W 7.0–23.0 MHz)
- 10: SW13 (N 13.57–13.87 MHz) (W 9.0–22.0 MHz)
- 11: SW14 (N 15.0–15.9 MHz) (W 9.5–18.0 MHz)
- 12: SW16 (N 17.48–17.9 MHz) (W 10.0–22.0 MHz)

**Note:** N = SW Narrow-band, W = SW Wideband

## 4. Operation

S4825-DEMO board, a complete analog tune and analog display radio, is very easy to operate:

1. Switch the SW Wide/Narrow-band selector J8 to the desired SW Wideband or Narrow-band.
2. Switch the tuner VDD connector J4 to the desired VABT or VCC.
3. Put two AAA batteries into the battery compartment.
4. Switch the power switch to the ON position. The board will power up to a radio band according to the position of the band switch.
5. Change the band switch to the desired band.
6. Rotate the tuning wheel and find the desired frequency.
7. Rotate the volume control wheel or press the volume control push buttons to get a comfortable volume.

**Note:** For FM listening, the earphone cable must be connected to the board when J2 is set to "HP ANT" or an external antenna must be connected to the BNC connector when J2 is set to "BNC".

For AM listening, the ferrite antenna must be connected to the board and the J3 is set to "Ferrite" before Turning on the radio or band switching to AM.

For FM/AM sensitivity and SNR test, the tuner output volume level must be set to maximum by pressing push button S4, or you might get degraded test results.

# Si4825-DEMO

## 5. Bill of Materials

- ATAD AM/FM/SW receiver IC Si4825 with external 32.768 kHz crystal oscillator support
- LM4910 Audio amplifier IC
- See Table 2 for details

**Table 2. Si4825-DEMO Board Rev1.1 Bill of Materials**

Item	Qty	Reference	Description	VALUE
1	5	C1 C16 C19 C24 C39	CAP,SM,0603,X7R	0.1 $\mu$
2	2	C23 C27	CAP,SM,1210,X7R	220 $\mu$
3	1	C13	CAP,SM,1210,X7R	47 $\mu$
4	2	C14 C25	Electrolytic capacitor	100 $\mu$ /4 V
5	2	C2-3	CAP,SM,0603,X7R	22p
6	2	C30-31	CAP,SM,0603,X7R	33n
7	1	C33	CAP,SM,0603,X7R	10p
8	1	C34	CAP,SM,0603,X7R	33p
9	3	C4 C12 C15	CAP,SM,0603,X7R	4.7 $\mu$
10	2	C5 C36	CAP,SM,0603,X7R	0.47 $\mu$
11	2	C8 C10	CAP,SM,0603,X7R	100p
12	1	C11	CAP,SM,0603,X7R	150p
13	1	C18	CAP,SM,0603,X7R	330p
14	1	R25	RES,SM,0603	0R
15	1	R22	RES,SM,0603	12k
16	1	R27	RES,SM,0603	100R
17	1	R31	RES,SM,0603	1k
18	1	R32	RES,SM,0603	10R
19	1	R17	RES,SM,0603	10k
20	1	R41	RES,SM,0603	120k
21	1	R3	RES,SM,0603	2.2k
22	2	R45 R5	RES,SM,0603	200R
23	3	R6 R23 R34	RES,SM,0603	100k
24	1	R20	RES,SM,0603	6.8k
25	2	R37 R38	RES,SM,0603	56k



**Table 2. Si4825-DEMO Board Rev1.1 Bill of Materials (Continued)**

Item	Qty	Reference	Description	VALUE
26	1	R36	RES,SM,0603,Tolerance $\pm 1\%$	33k
27	1	R29	RES,SM,0603,Tolerance $\pm 1\%$	140k
28	1	R43	RES,SM,0603,Tolerance $\pm 1\%$	40k
29	1	R44	RES,SM,0603,Tolerance $\pm 1\%$	47k
30	5	R7 R9 R11 R12 R15	RES,SM,0603,Tolerance $\pm 1\%$	10k
31	1	R8	RES,SM,0603,Tolerance $\pm 1\%$	50k
32	4	R10 R28 R33 R35	RES,SM,0603,Tolerance $\pm 1\%$	20k
33	1	R14	RES,SM,0603,Tolerance $\pm 1\%$	60k
34	1	L1	RES,SM,0603	0R
35	3	B4 B5 B6	FERRITE BEAD,SM,0603	2.5k/100M
36	1	B1	FERRITE BEAD,SM,0603	NP
37	1	VR1	100k, $\pm 10\%$ , Variable resistor(POT)	100k
38	1	VR2	10k, $\pm 20\%$ , Variable resistor(POT)	10k
39	1	U1	SI4825, SOIC16	Si4825
40	1	U2	LM4910MA, SO8	LM4910MA
41	1	D1	LED	LED
42	2	D2 D4	DIODE, SM, ESD, SOT23	BAV99
43	1	Q1	TRANSISTOR NPN SOT23	2SC9018
44	1	Y1	CRYSTAL	32.768 kHz
45	1	J1	BNC VERTICAL	BNC For FM/SW testing
46	1	J6	SMA VERTICAL	SMA For AM testing
47	4	J2 J3 J4 J8	Single pole two throw switch	
48	1	J5	Earphone jack	
49	1	S1	Two pole two throw switch	
50	1	S2	Single pole twelve throw switch	
51	1	S3 S4	Push button	
52	1	ANT1	AW ferrite stick antenna	220 $\mu$ H
53	1	BAT1	BATTERY BOX, AAA*2 SIZE	
54	2	TP1 TP2	CONN,TH,1x2,HDR	CONN,TH,1x2,HDR

## 6. Schematics

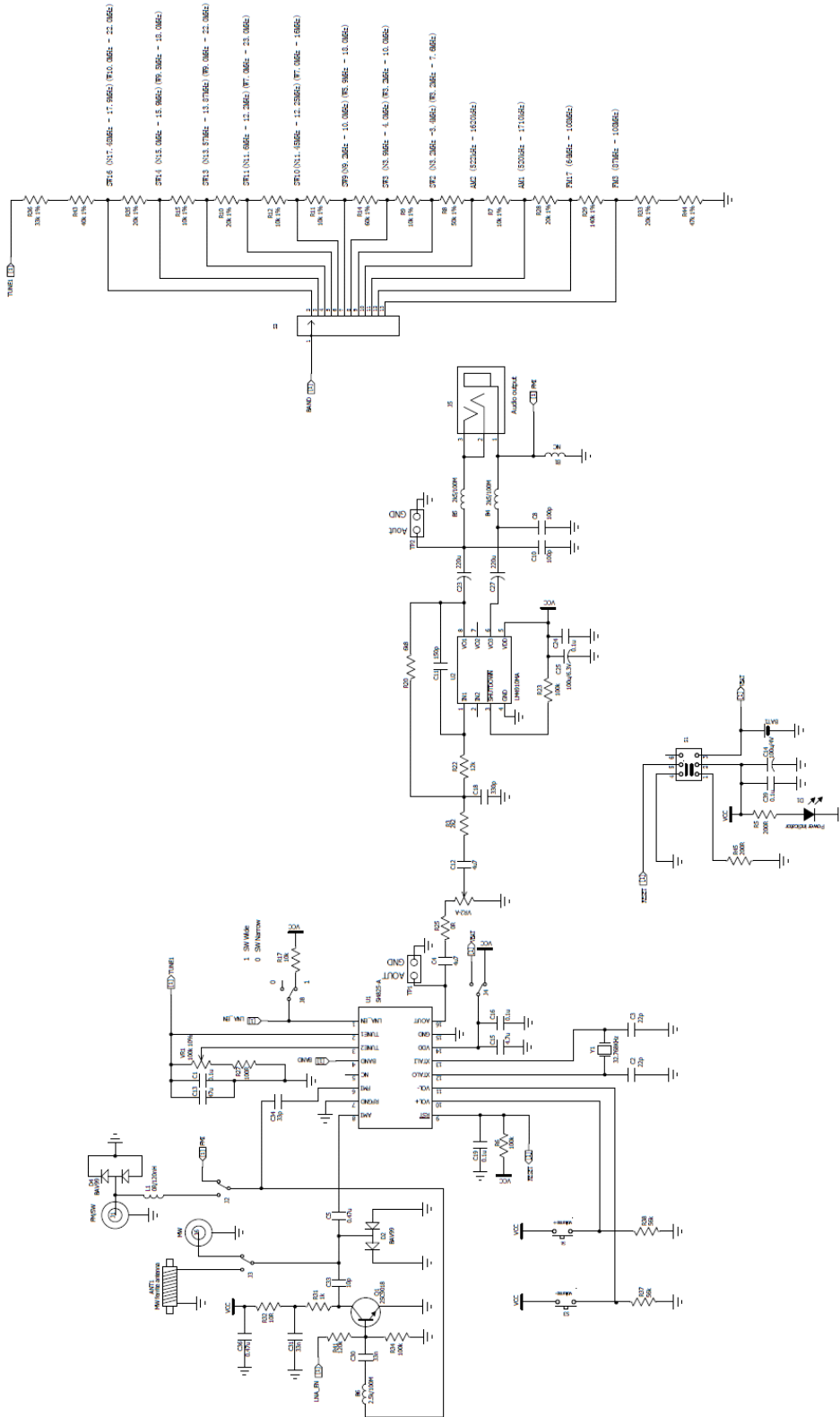

Figure 3. Si4825-DEMO Board Rev 1.1 Schematic

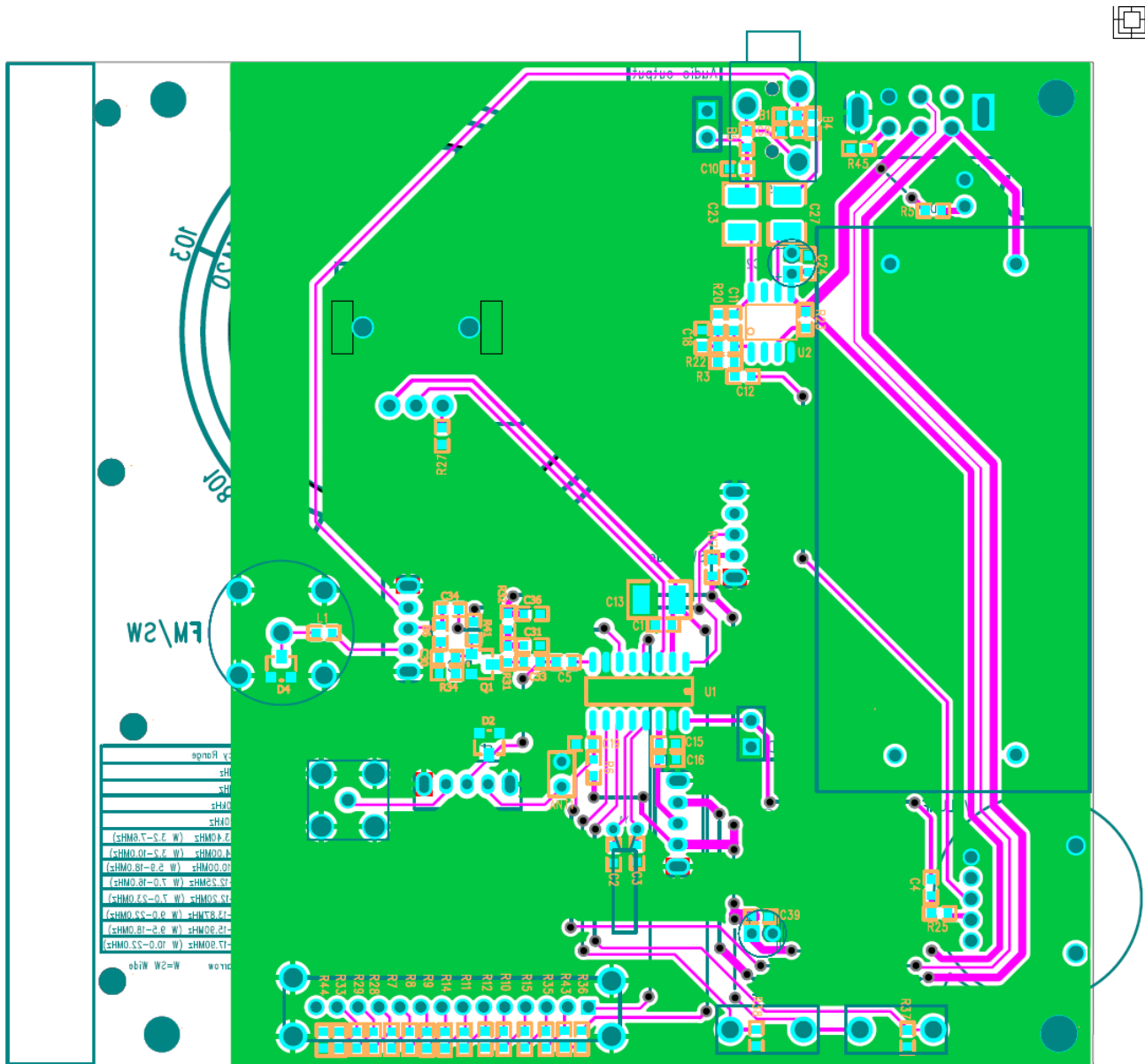

Figure 4. Si4825-DEMO Board Gerber Rev 1.1



# SKYWORKS®

**Connecting Everyone  
and Everything,  
All the Time**



**Portfolio**

[www.skyworksinc.com](http://www.skyworksinc.com)

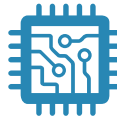

**Quality**

[www.skyworksinc.com/quality](http://www.skyworksinc.com/quality)



**Support & Resources**

[www.skyworksinc.com/support](http://www.skyworksinc.com/support)

**Copyright © 2021 Skyworks Solutions, Inc. All Rights Reserved.**

Information in this document is provided in connection with Skyworks Solutions, Inc. ("Skyworks") products or services. These materials, including the information contained herein, are provided by Skyworks as a service to its customers and may be used for informational purposes only by the customer. Skyworks assumes no responsibility for errors or omissions in these materials or the information contained herein. Skyworks may change its documentation, products, services, specifications or product descriptions at any time, without notice. Skyworks makes no commitment to update the materials or information and shall have no responsibility whatsoever for conflicts, incompatibilities, or other difficulties arising from any future changes.

No license, whether express, implied, by estoppel or otherwise, is granted to any intellectual property rights by this document. Skyworks assumes no liability for any materials, products or information provided hereunder, including the sale, distribution, reproduction or use of Skyworks products, information or materials, except as may be provided in Skyworks' Terms and Conditions of Sale.

THE MATERIALS, PRODUCTS AND INFORMATION ARE PROVIDED "AS IS" WITHOUT WARRANTY OF ANY KIND, WHETHER EXPRESS, IMPLIED, STATUTORY, OR OTHERWISE, INCLUDING FITNESS FOR A PARTICULAR PURPOSE OR USE, MERCHANTABILITY, PERFORMANCE, QUALITY OR NON-INFRINGEMENT OF ANY INTELLECTUAL PROPERTY RIGHT; ALL SUCH WARRANTIES ARE HEREBY EXPRESSLY DISCLAIMED. SKYWOKS DOES NOT WARRANT THE ACCURACY OR COMPLETENESS OF THE INFORMATION, TEXT, GRAPHICS OR OTHER ITEMS CONTAINED WITHIN THESE MATERIALS. SKYWOKS SHALL NOT BE LIABLE FOR ANY DAMAGES, INCLUDING BUT NOT LIMITED TO ANY SPECIAL, INDIRECT, INCIDENTAL, STATUTORY, OR CONSEQUENTIAL DAMAGES, INCLUDING WITHOUT LIMITATION, LOST REVENUES OR LOST PROFITS THAT MAY RESULT FROM THE USE OF THE MATERIALS OR INFORMATION, WHETHER OR NOT THE RECIPIENT OF MATERIALS HAS BEEN ADVISED OF THE POSSIBILITY OF SUCH DAMAGE.

Skyworks products are not intended for use in medical, lifesaving or life-sustaining applications, or other equipment in which the failure of the Skyworks products could lead to personal injury, death, physical or environmental damage. Skyworks customers using or selling Skyworks products for use in such applications do so at their own risk and agree to fully indemnify Skyworks for any damages resulting from such improper use or sale.

Customers are responsible for their products and applications using Skyworks products, which may deviate from published specifications as a result of design defects, errors, or operation of products outside of published parameters or design specifications. Customers should include design and operating safeguards to minimize these and other risks. Skyworks assumes no liability for applications assistance, customer product design, or damage to any equipment resulting from the use of Skyworks products outside of Skyworks' published specifications or parameters.

Skyworks, the Skyworks symbol, Sky5®, SkyOne®, SkyBlue™, Skyworks Green™, Clockbuilder®, DSPLL®, ISOModem®, ProSLIC®, and SiPHY® are trademarks or registered trademarks of Skyworks Solutions, Inc. or its subsidiaries in the United States and other countries. Third-party brands and names are for identification purposes only and are the property of their respective owners. Additional information, including relevant terms and conditions, posted at [www.skyworksinc.com](http://www.skyworksinc.com), are incorporated by reference.