

APR

Scarab Site Cleaning System User Guide

Contents

Safety & Regulatory Information	3
Specification	5
Introduction and General Overview	6
System Configurations and Package Options	6
Scarab Site Cleaning System Components	7
Set-up	8
Application Set-up & Motion Control	12
Navigation	14
System Icons & Descriptions	14
Thermal Profile Controls	17
System Operation	
New Cleaning Profile	22
Open/Import Profile	26
Save Profile or Create Directory	27
Using a Saved Cleaning Profile	28
Auto-Profile	30
Collection Chamber Cleaning	31
Data Backup	33
Data Restore	34
Capture Screen Shot	35
Load Screen Shot	36
Ethernet Connection and File Management	37
Calibration and Adjustment	39
Setting the Home Position	41
Crosshair Laser Setup	43
Calibrating the Laser Height Sensor	45
External Thermocouple Calibration	52
Reflow Blower Calibration	53
Focus Blower Setup	56
Surround Blower Setup	58
Reflow Heater Calibration	61
Focus Heater Calibration	63
Surround Heater Calibration	65
Glue Remover Calibration	67
Solder Path Cleaning	74
Alternate Software Installation	77
Factory Restore	78
Save Factory Default	78
Reflow Nozzles, Vacuum Nozzles, Accessories, and Spare Parts	79
Technical Support and Warranty	79

Safety and Regulatory Information

WARNING

- TO PREVENT FIRE OR SHOCK HAZARD, DO NOT EXPOSE SYSTEM TO MOISTURE.
- TO PREVENT FIRE OR SHOCK HAZARD, DO NOT USE FLAMMABLE SOLVENTS NEAR OR ON THE SYSTEM WHILE CONNECTED TO A POWER SOURCE.
- TO PREVENT POSSIBILITY OF INJURY OR DAMAGE TO THE SYSTEM, DO NOT OPERATE WITH ANY COVERS OR PANELS REMOVED.
- **CHANGES OR MODIFICATIONS MADE TO THIS PRODUCT WITHOUT EXPRESS APPROVAL FROM APR COULD VOID THE USERS AUTHORITY TO OPERATE THE EQUIPMENT.**
- Read and understand the entire Operator's Manual before installation or operation of the Scarab Site Cleaning System. Heed all warnings on the system and in the operating instructions.
- The Scarab Site Cleaning System is only for the removal of residual solder and/or reworkable glue from printed circuit boards or components by properly trained personnel. If you are not familiar with the proper and safe operation of the unit, do not operate it until properly trained.
- Operate the unit from the type of power source indicated on the serial number label.
- Use only the supplied power cord. Avoid damage to the power cord. If damage should occur, replace it with the approved APR replacement power cord.



- This CAUTION symbol on the equipment refers the user to the user guide for additional information. This symbol appears next to the relevant information in the manual.



- This HOT symbol on the equipment warns the user of a hot surface and potential injury if touched. This symbol appears next to the relevant information in the manual.



- This HEAVY LIFTING symbol on the packaging warns the user to team lift the Scarab Site Cleaning System during removal from packaging and installation on the workbench. This symbol appears next to the relevant information in the manual.



- This PINCH POINT symbol on the equipment warns the user of a potential injury. This symbol appears next to the relevant information in the manual.



- This LASER symbol on the equipment warns the user of possible exposure to laser radiation. This symbol appears next to the relevant information in the manual.



- This EYE PROTECTION symbol on the equipment warns the user of potential injury due to flying debris. This symbol appears next to the relevant information in the manual.





When operating this equipment, please exercise caution. If this unit is used in a manner, which it is not intended for, serious personal injury, may occur. Please read this user guide thoroughly prior to use.

The main power cord is a means for disconnecting the equipment from an operating energy source. Position the equipment in a way that impedes the disconnection of the main power cord in case of an emergency.

Mandatory use of a grounding strap is required when operating the equipment.



- **Laser Safety**

LASER RADIATION	
 LASER 2	DO NOT STARE INTO BEAM LASER HEIGHT SENSOR MAXIMUM OUTPUT: 1mW PULSE DURATION: 2.5mS WAVELENGTH: 660nm
	NE PAS REGARDER LE FAISCEAU LASER HAUTEUR CAPTEUR SORTIE MAXIMUM: 1mW DURÉE DE POULS: 2.5mS LONGUEUR D'ONDE: 660nm
	CROSSHAIR ALIGNMENT LASER MAXIMUM OUTPUT: <5mW PULSE DURATION: N/A WAVELENGTH: 650nm
	CROSSHAIR ALIGNEMENT LASER SORTIE MAXIMUM: <5mW DURÉE DE POULS: N/A LONGUEUR D'ONDE: 650nm
IEC 60825-1:2014	

- Do not stare into the beam or view directly with optical instruments.
- Laser Height Sensor Module
 - The Laser Height Sensor incorporates a Class 2 laser. Because of its brightness, Class 2 laser light will be too dazzling to stare into for extended periods. Momentary viewing is not considered hazardous since the upper radiant power limit on this type of device is less than the MPE (Maximum Permissible Exposure) for momentary exposure of 0.25 second or less. Intentional extended viewing, however, is considered hazardous.
- Crosshair Alignment Laser Module
 - A Class 3R laser is considered safe if handled carefully, with restricted beam viewing. With a class 3R laser, the MPE (Maximum Permissible Exposure) can be exceeded, but with a low risk of injury. Visible continuous lasers in Class 3R are limited to 5mW.

Other Safety Tips

- Unplug the unit before cleaning. Clean the exterior of the system with a damp cloth. Do not use solvent-based cleaners.
- Slots and openings in the system are provided for ventilation and to ensure reliable operation and protection from overheating. The openings should never be blocked or covered.
- Do not overload power outlets and extension cords. This can result in fire or electric shock.

The Scarab Site Cleaning System is safety certified by TÜV SÜD, and it complies with UL, CSA, and CE standards.

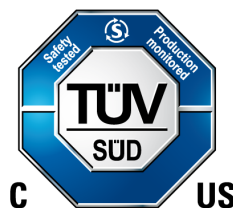

Specifications

Input Voltage	208-240VAC, 50/60Hz, 15 Amp Single Phase	
Power Consumption		
System Total	3600 Max. (2800W Typical)	
Inner Zone	900W	
Outer Zone	1800W	
Reflow Heater	550W	
Operating Temperature	41°F (5°C) to 104°F (40°C)	
Maximum Relative humidity	80% at 88°F (31°C) decreasing linearly to 50% at 104°F (40°C)	
Maximum Altitude	6500 ft. (2km)	
Pollution Degree	2 per IEC 644	
Insulation category	II	
Temperature Control Type	Closed-Loop Control (Thermocouple)	
Laser Class	Crosshair Alignment Laser Module	
	Maximum Output	<5mW
	Pulse Duration	N/A
	Wavelength	650nm
	Divergence	<2mrads
	Laser Height Sensor Module	
	Maximum Output	1mW
	Pulse Duration	2.5mS
	Wavelength	660nm
	Divergence (Parallel)	0.5 mrads
	Divergence (Perpendicular)	2 mrads
Maximum Source Temperature		
Reflow Head	350°C (662°F)	
Pre-Heater (Inner/Outer)	350°C (662°F)	
Airflow		
Control	Low, Medium, & High	
Vacuum (Venturi generated)	23 inHg @80-100 psi	
Collection Chamber Capacity	6.3 ml	
PCB Handling Capability		
Maximum Size	12" x open (304.8mm x open)	
Maximum Thickness	0.25" (6mm)	
System Dimensions W x D x H	21" x 29" x 31" (533mm x 737mm x 787mm)	
Weight	140lbs (63.5kg)	
Certifications	TÜV SÜD	

Description

The cost and complexity of today's electronic assemblies are forcing manufacturers to reexamine the tools and techniques in operation today. Contactless cleaning of component pads prior to component replacement is a growing need in the industry. The Scarab Site Cleaning System ensures accurate and repeatable cleaning of the component pad in one user-friendly system. The Scarab Site Cleaning System redefines performance and addresses the technical demands presented by component manufacturers today.

The trend in the industry is to move away from manual methods of cleaning component pads. The risks to the PCBA are inconsistent solder removal resulting in poor adhesion, solder resist damage resulting in opens or shorts, and thermal damage to the PCBA. In an effort to address the costs and risks associated with the manual process, the industry is looking towards a contactless cleaning as a solution.

The Scarab Site Cleaning System addresses the industry needs with an automated system capable of cleaning components pads without contact. The motorized design allows the system to clean without contact component pads up to 50mm x 50mm within a 101mm x 101 mm area. The system can accurately and repeatedly clean pads with pitches of 0.2mm to 2.0mm. The open-ended board holder fits a wide variety of large, small and odd-shaped boards while allowing positioning over the patented dual subzone preheater.

Source temperatures and time intervals can be modified "On-the-Fly", eliminating the need to wait for the current profile to terminate before modifications can be made with one exception. While in the cleaning zone, the system automatically calculates the time needed to remove solder and glue and adjusts the time according to user defined inputs. Precise solder joint temperatures are measured and displayed on a real time graphical display, thus providing the necessary data to accurately and easily establish the optimum reflow profile for each particular application within minutes.

The Scarab Site Cleaning System joins the Scorpion Rework System as a solution to the challenges faced by manufacturers in today's rework environment. The Scarab Site Cleaning System is available in the following item number:

Item	Description
APR-2000-SCS	Scarab Site Cleaning System

Scarab Site Cleaning System Components - APR-2000-SCS



Laser Radiation Warning
Do not stare into the beam or view directly with optical instruments.

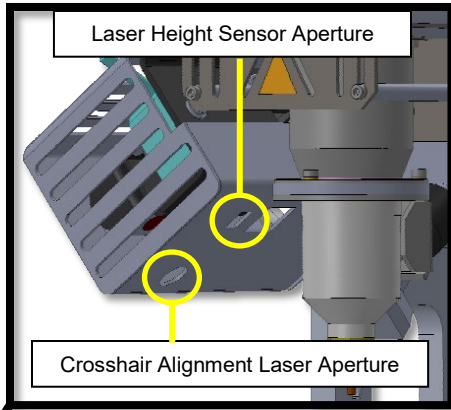

Front

Back

1	Power "On" LED	12	Chassis Fan
2	Auxiliary Power and Air Connection	13	Grounding Point
3	External Type K thermocouple	14	Ethernet Connection
4	Laser Height Sensor	15	Glue Scrapper Air Connection
5	Crosshair Laser	16	USB Connection
6	Reflow Nozzle	17	Shop Air Connection
7	Board holder Assembly	18	Monitor Connection
8	Optional Under board Support	19	Power Connection
9	Circuit breaker		
10	Vacuum Nozzle		
11	Collection Chamber		

Set-up



The main unit is very heavy. Please uncrate the unit with 2 people.



DO NOT LIFT THE MAIN UNIT BY THE PCBA BOARD HOLDER. LIFTING BY THE BOARD HOLDER WILL DAMAGE THE ASSEMBLY!



Before setting up your equipment

- Ensure your Scarab Site Cleaning System has arrived complete
- Provide a location that allows the user to operate this machine in a comfortable, well-spaced environment



Every Scarab Site Cleaning System has been factory assembled and calibrated.

- Recalibration is not necessary after initial setup.
- Verifying calibration and product functionality is strongly recommended prior to initial use



Power-up Sequence

- Attach an appropriate power plug to the stripped end of the power cord. Use recommended power plugs:
 - Nema 6-20
 - Nema L6-20
 - IEC 60309

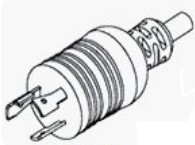

Use the following diagrams together with the manufacturer's recommended procedure for hooking up wires to a power plug

Connecting the Air Source

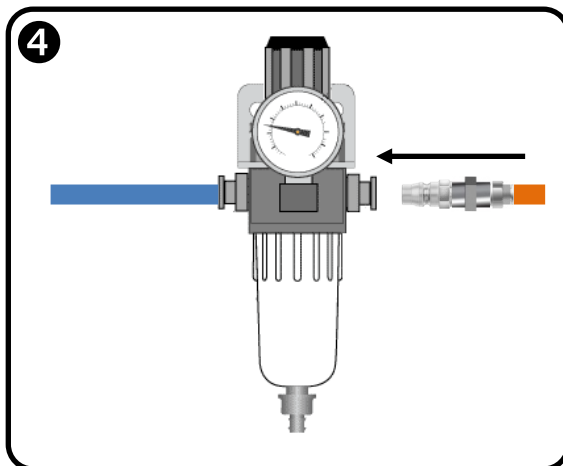
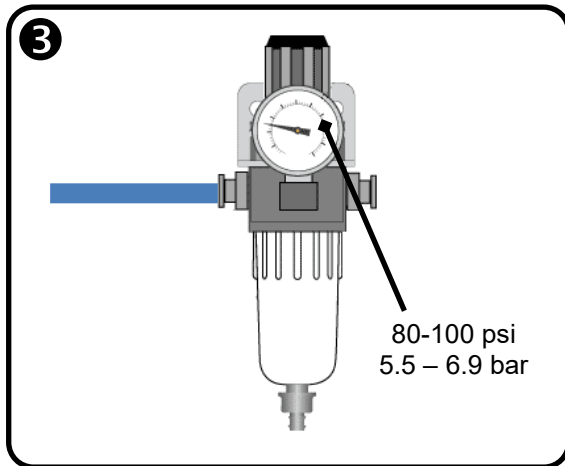
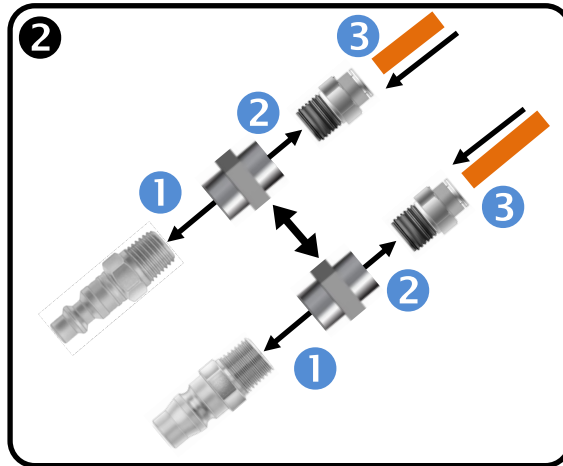
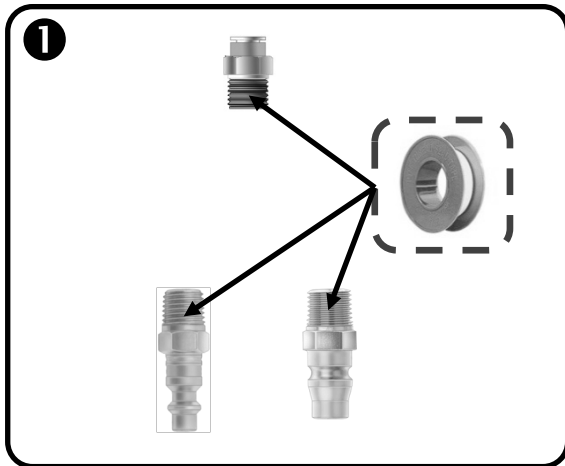

Power Connector

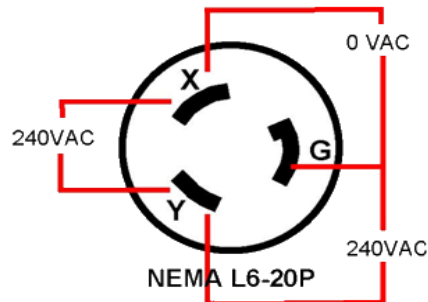
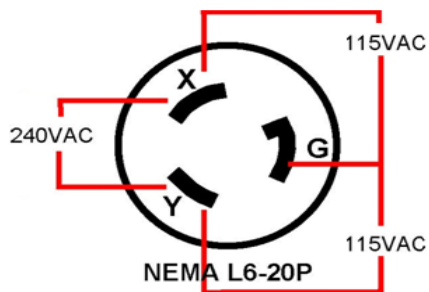

Configuration 1

- Measure from **X** to **Y**. This measurement should always be 208VAC to 240VAC
- Measure from **G** to **X**. This measurement will be 110VAC-125VAC
- Measure from **G** to **Y**. This measurement will be 110VAC-125VAC

Configuration 2

- Measure from **X** to **Y**. This measurement should always be 208VAC to 240VAC
- Measure from **G** to **X**. This measurement will be 0 VAC
- Measure from **G** to **Y**. This measurement will be 208VAC-240VAC

Connections

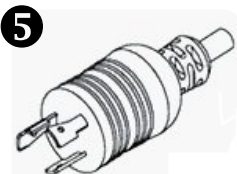
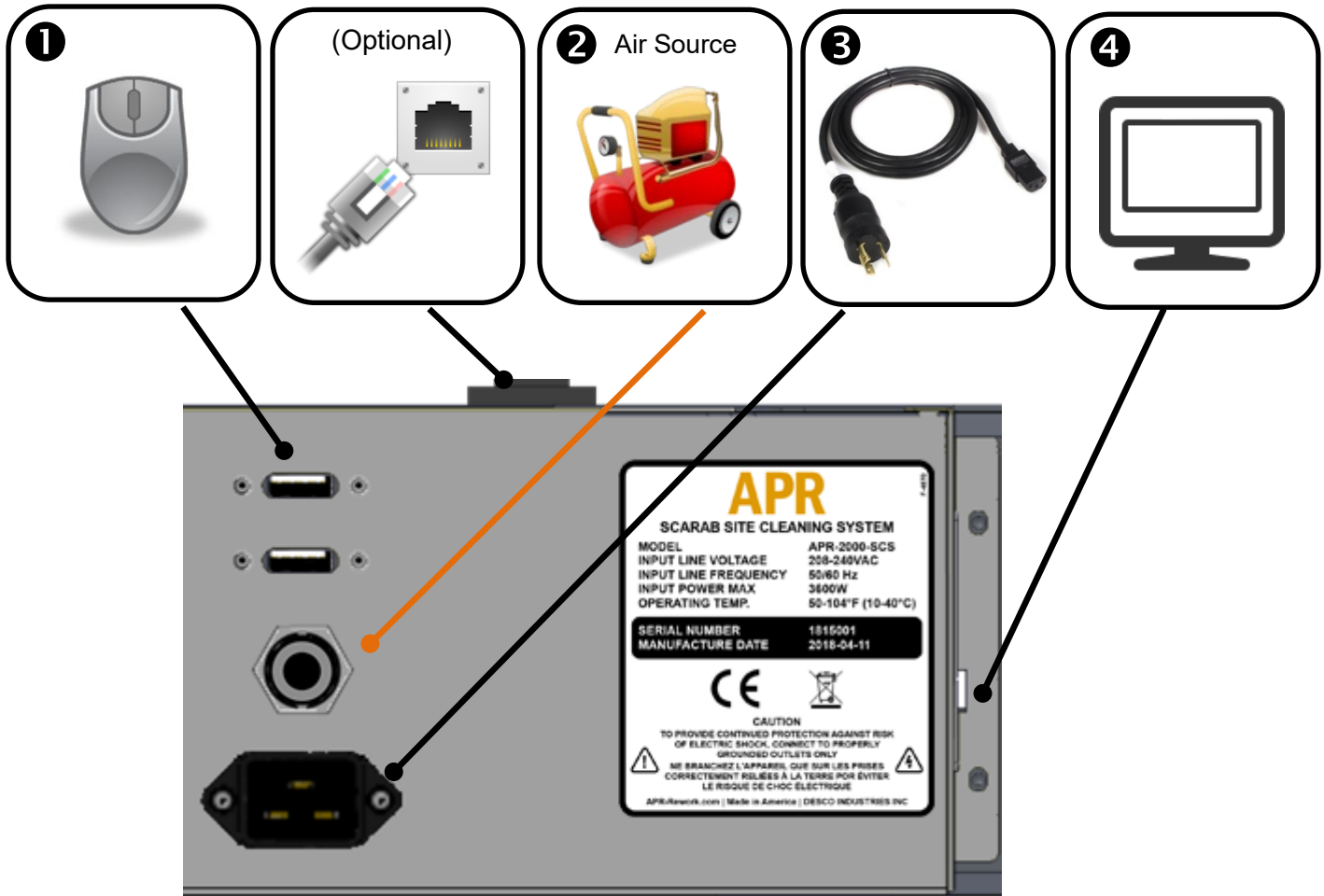

5 Insert the power cord plug into a receptacle

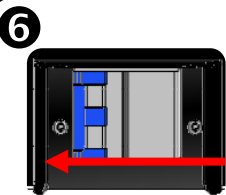

6 Set the circuit breaker switch to the "on" position



7 When the title screen appears, your Scarab Site Cleaning System is ready for operation!

8



Click the log-in icon. The system has three levels of permissions; operator, engineer, and administration modes.
Enter the appropriate password for the user level with the onscreen keyboard.
Default Operator password=operator
Default Engineer password=engineer
Default Administration password=guru



Application Setup & Motion Control

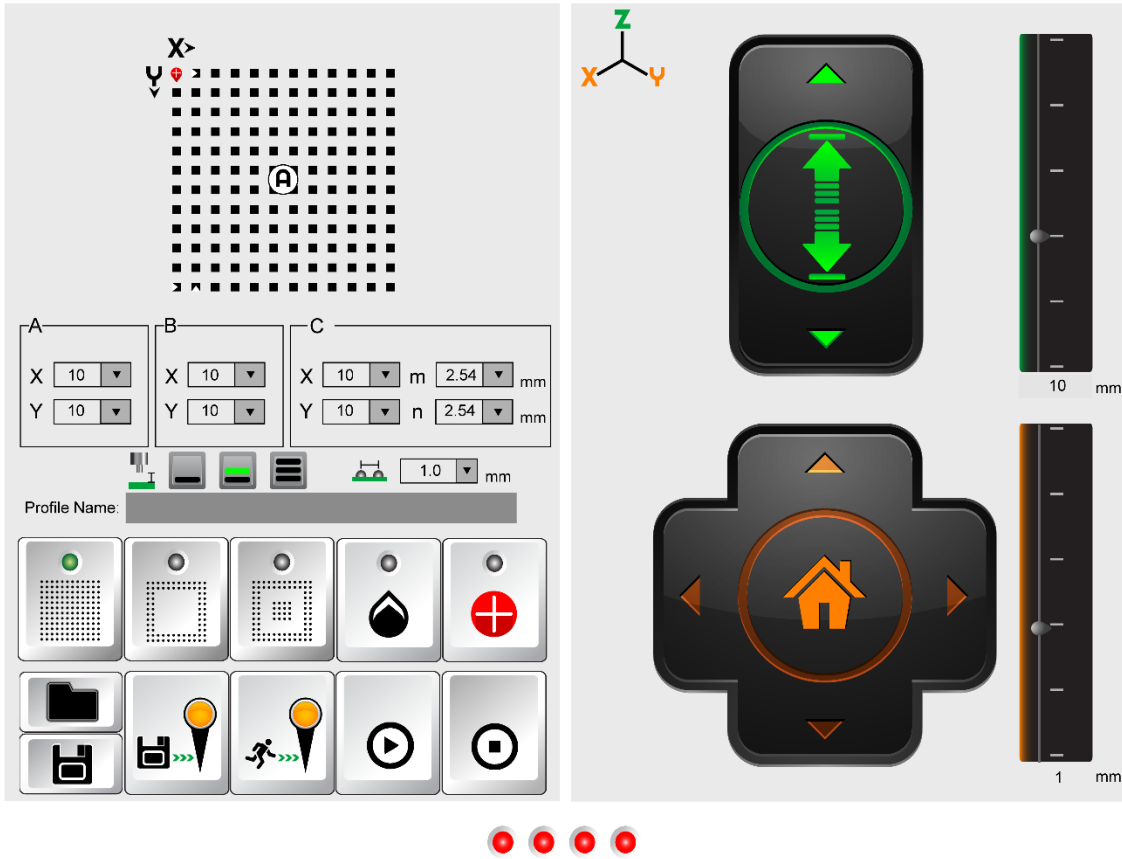

Application Setup Controls

	Full Matrix		Enable Glue Removal Option		File Open		Test Run
	Perimeter Matrix		Enable Alignment Laser		File Save		
	Perimeter with Center matrix		Start Location		Go To Marker Location		
	Board Clearance		Component Pitch				

Motion Controls

Z-Axis

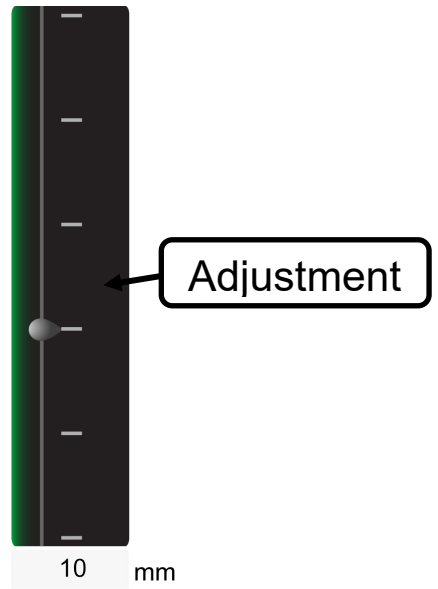
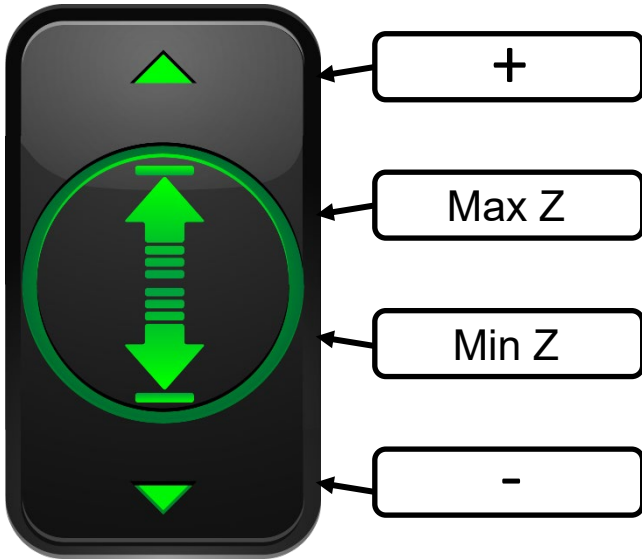

X/Y-Axis

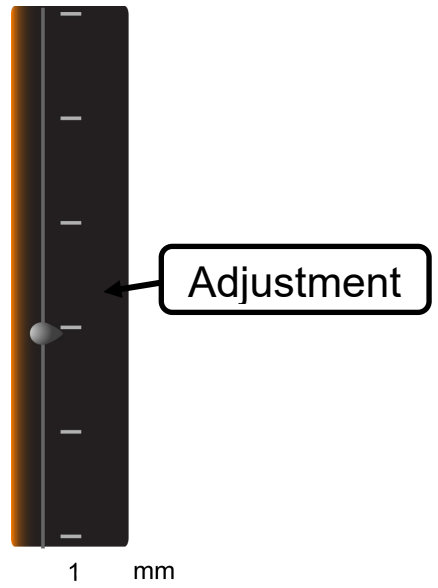
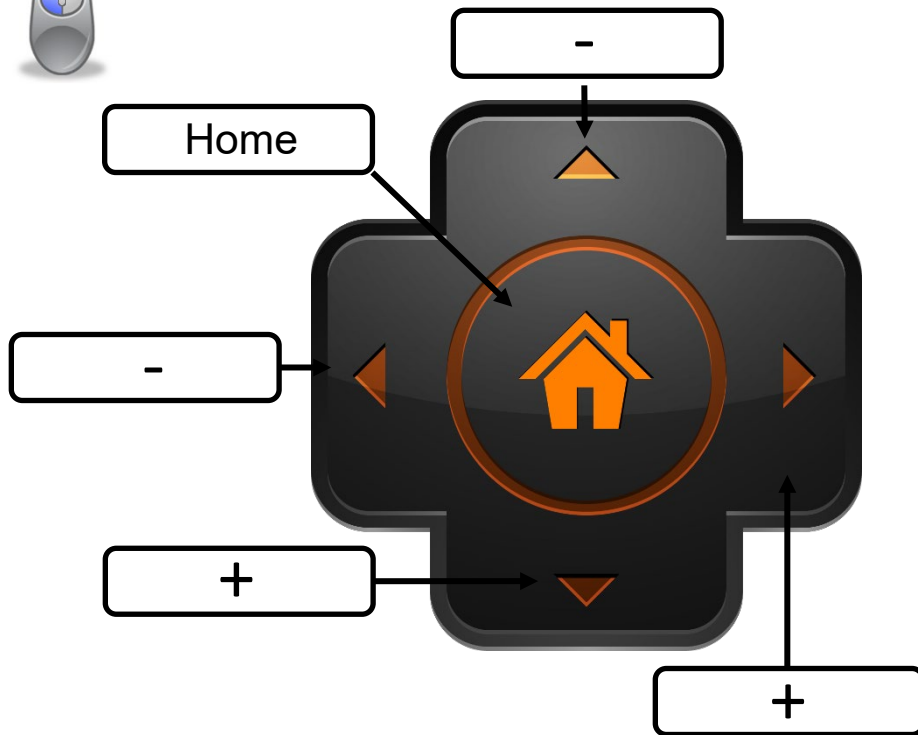

Navigation



- Each dot corresponds to a different screen. Select a screen by left-clicking on the appropriate dot.
- The first dot is the title screen, the second dot is the motion control window, the third dot is thermal profile window, and the fourth dot is the system configuration window.

System Icons & Descriptions

	Login		Vacuum On-Off
	New Removal Profile		Connections
	Open/Import Profile		Motion Control
	Save/Export File		Glue Remover On-Off
	Start Profile		Reflow Blower
	Stop Profile		Focus Blower
	Auto Profile		Surround Blower
	Cycle Advance		Reflow Heater Calibration Calibration in Progress
	Repeat On-Off		Focus Heater Calibration
	Screen Capture		Surround Heater Calibration
	Open-Close Screen Shot		Thermocouple Calibration
	Language Select		Unmounts USB Drive
	Back-up & Restore		Software Shutdown
	Restore Factory Settings		User Guide
	Ethernet Icon		



User Guide

1



- Hover the cursor over the user guide icon

2



- Left click the icon to activate
- Left click again to deactivate



Software Shutdown



- APR recommends shutting down the software prior to removing power to the unit. This will minimize the risk of file corruption to the computer's memory card.

1



- Hover the cursor over the software shutdown icon

2



- Left click the icon to activate.



Tool Tip language select.

1



- Hover the cursor over the tool tip language select icon.

2



- Right click on the mouse button to access the language options box.

3



- The language option box displays showing the current language setting.

4



- Use the scroll wheel to the language.

5



- Right click the mouse button to save changes.

6



- Left click the icon to activate
- Left click again to deactivate



Profile Window

- Displays the temperature profile and data table.

Profile Window Overview

Operator Mode

Icon Menu Bar: displays available icons based on level of access

Active Profile Area: displays the time and temperature settings for the selected profile.

Profile Data Table: displays time, temperature, and ramp rate data of the active profile.

Profile Information area: displays the profile mode, profile name, total cycle count, total cycle run time.

Screen Capture Area: displays screen capture controls

Time	-1
Reflow	-
Small	-
Large	-
IR	-
TC1	-
TC2	-
TC3	-

Reflow Preheat
 Name: clean_bga
 Total Cycle Count:
 Total Cycle Run Time:



Edit Profile

- Changing profile information requires the profile to be unlocked.



- Left click the Lock icon



- The profile is open for editing.

Active Profile Area

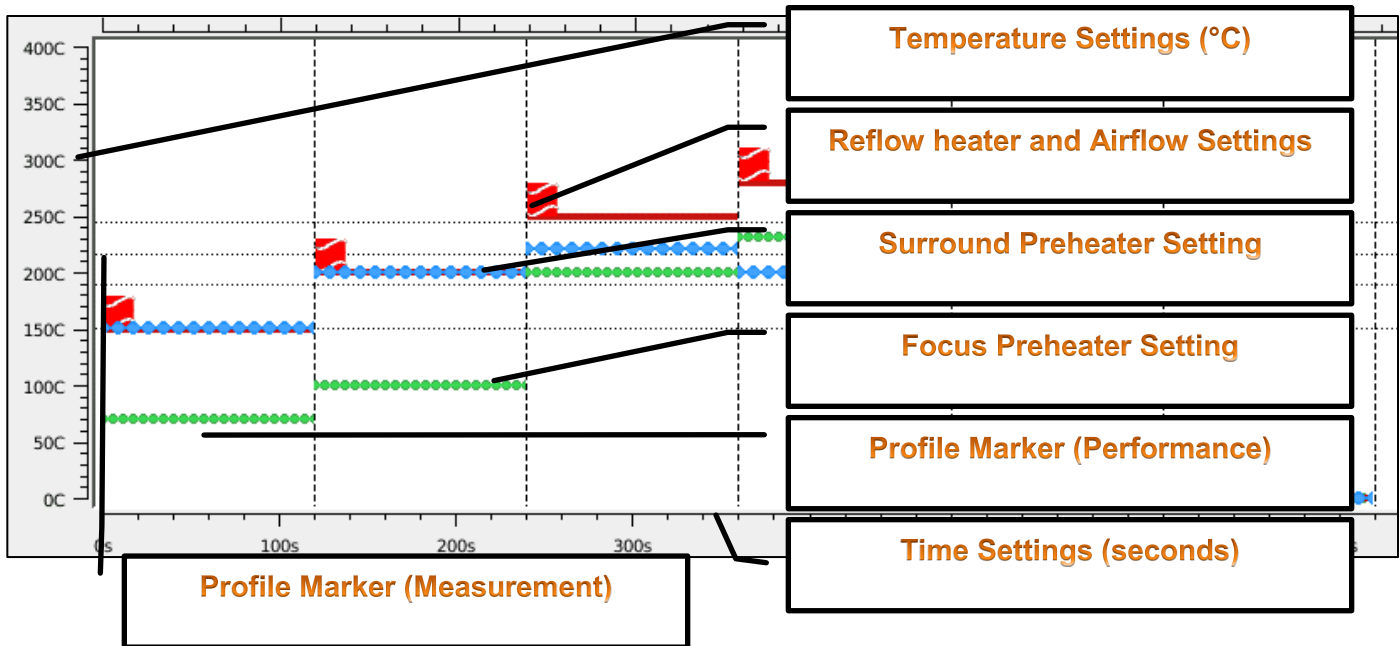

Changing Profile Values



Changing airflow

- Left click on the box area to change airflow.
- 3 available settings, low (1 bar), medium (2 bars), and high (3 bars).



Changing temperature

- Each line corresponds to a different heater
- Temperature can be changed in two ways.

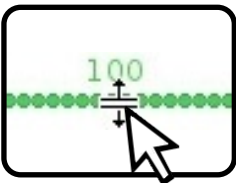

Changing temperature - Method 1

- Left click the desired heater. The cursor will change to double arrows. Drag & drop to the desired temperature.



Changing temperature - Method 2

- Right click the desired heater. The temperature adjust dialog box will appear. Use the up and down arrows to select the desired temperature. Click "ok" to enter the desired temperature.



Changing Time Zones

- The default configuration is 4 heating zones and 1 for cooling. An additional 4 zones of heating and 1 of cooling can be added.
- The duration of each zone can be changed in two ways.

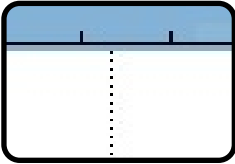

Adding additional time zones

- Hover the cursor over the time zone bar area located at the top of the graph. The cursor will change to the "zone" icon. Left click to add an additional zone.

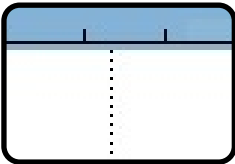

Removing time zones

- Hover the cursor over the time zone bar area located at the top of the graph. The cursor will change to the "zone" icon. Right click to remove a zone.

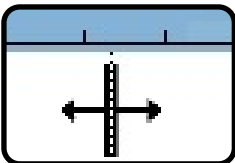

Changing time zone duration - Method 1

- Left click the desired zone. The cursor will change to double arrows. Drag & drop to the desired time.



Changing time zone duration - Method 2

- Right click the desired zone. The time adjust dialog box will appear. Use the up and down arrows to select the desired time. Click "ok" to enter the desired time.



Profile Markers (Performance)

- 8 markers are available
- Markers provide time, temperature, and ramp rate information at user defined intervals

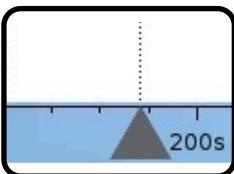

Adding Profile Markers

- Hover the cursor over the time zone bar area located at the bottom of the graph. The cursor will change to the "marker" icon. Left click to add a marker. Markers are color-coordinated with the clocks displayed in the time and temperature table.

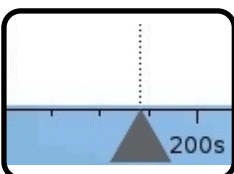

Removing Profile Markers

- Hover the cursor over the time zone bar area located at the bottom of the graph. The cursor will change to the "marker" icon. Right click to remove a marker.



Profile Data Table

- 1 System Performance information
- Displays 8 user-defined profile markers (performance)
- Provides temperature and ramp rate data

System Performance information

Time		129	135	142	142				
Reflow		0	-	0	-				
Small		-	0	-	0	-			
Large		-	0	-	0	-			
IR		-	0	-	0	-			
TC1		-	0	-	0	-			
TC2		-	0	-	0	-			
TC3		-		-		-			

Internal Thermocouple; Reflow, Focus, & Surround

Profile Marker time (seconds)

Profile Marker temperature data (°C)

Profile Marker ramp rate data

IR
TC1
TC2
TC3

Repeatability verification:

- If external thermocouple plots were saved as part of a previous run.
- Left click "Real Time" data box on the appropriate external TC1,2,3 to enable / disable a comparison plot for the next run.

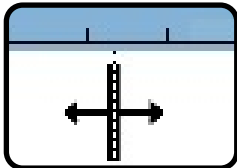

Changing Profile Marker location - Method 1

- Left click the desired profile marker. The cursor will change to double arrows. Drag & drop to the desired time.

Changing Profile Marker location - Method 2



- Right click the profile marker. The time adjust dialog box will appear. Use the up and down arrows to select the desired time. Click "ok" to enter the desired time.



Profile Markers (Measurement)

- Markers provide a reference line during profile operation



Adding Profile Markers

- Hover the cursor over the temperature zone bar area located on the left of the graph. The cursor will change to the "marker" icon. Left click to add a marker.



Removing Profile Markers

- Hover the cursor over the temperature zone bar area located on the left of the graph. The cursor will change to the "marker" icon. Right click to remove a marker.

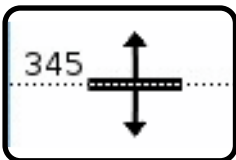

Changing Profile Marker location - Method 1

- Left click the desired profile marker. The cursor will change to double arrows. Drag & drop to the desired time.



Changing Profile Marker location - Method 2

- Right click the profile marker. The time adjust dialog box will appear. Use the up and down arrows to select the desired time. Click "ok" to enter the desired time.

Profile Information Area

Profile mode: remove

Name: /default

Total Cycle Count: 14

Total Cycle Run Time: 2:17 (hr:min)

Displays the current mode(remove, place, or calibration), profile name, and system cycle count and run time.



New Cleaning Profile

1

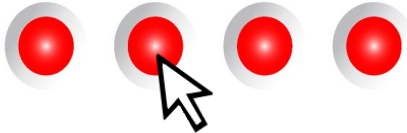

Go to Motion Control Screen

2



Press Home Button

3

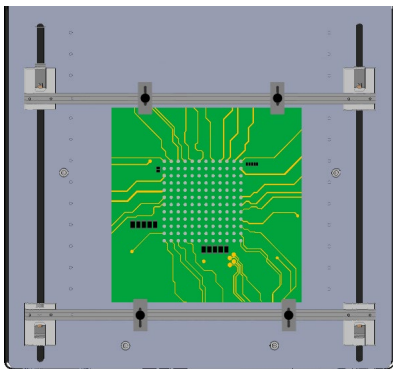

Load PCBA into Board Holder

4

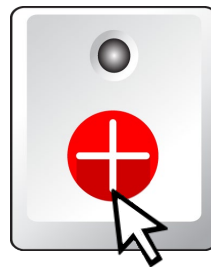

Activate Laser Crosshair

5

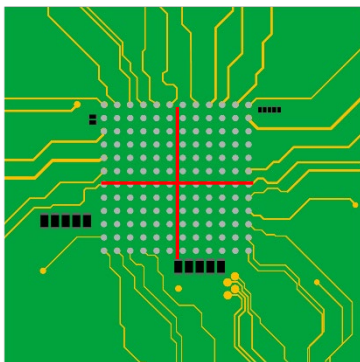

Center pad area over the preheater using crosshair laser

6

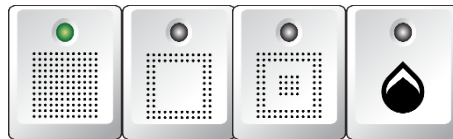

Select Application

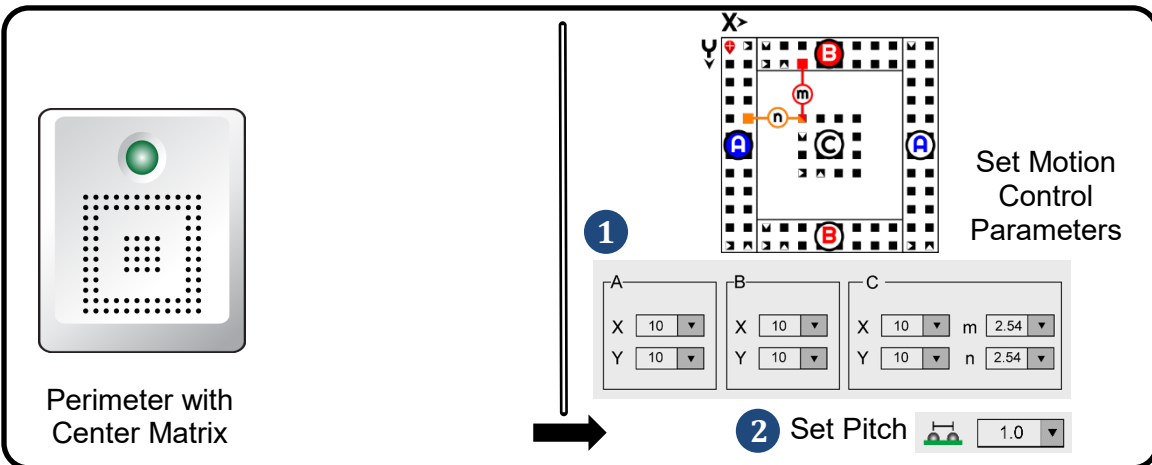
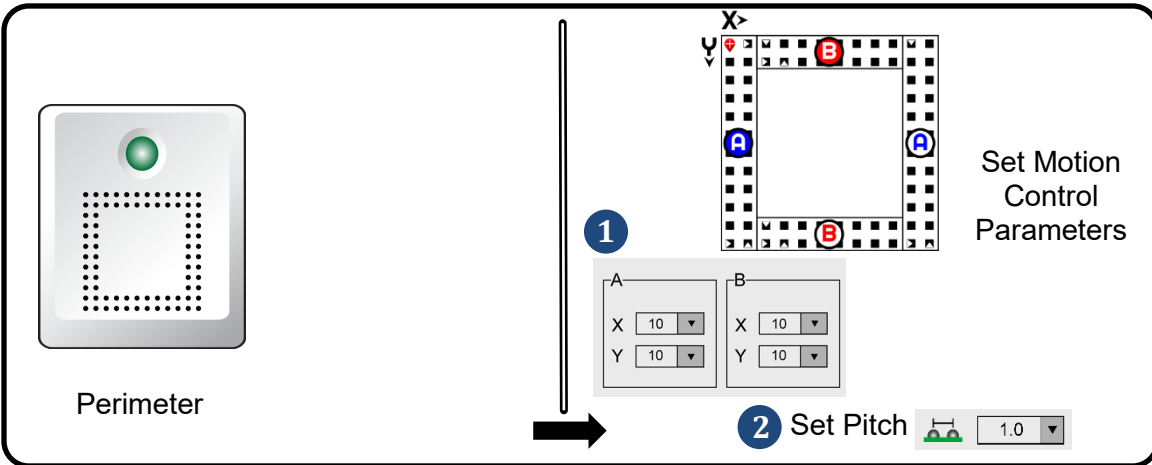
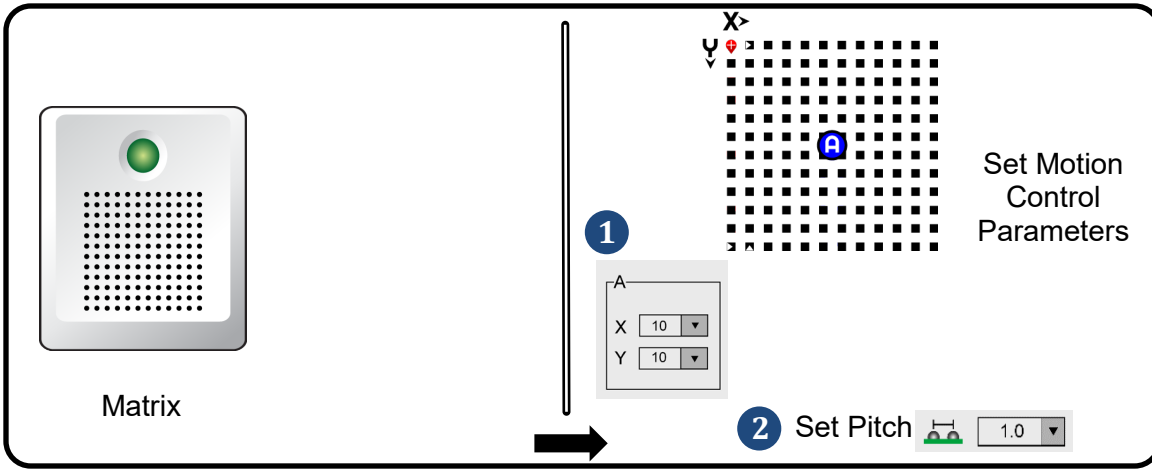

Underfill Removal Upgrade Kit, APR-SCS-UK1, adds the capability to assist in the removal reworkable underfill from PCBAs in designated areas. Using the kit outside of the prescribed areas may result in damage.

When activated the areas designated for use with APR-SCS-UK1, will be visible in the Motion Control Screen and will display the Glue Icon.



Perimeter

When Equipped with SCS-UK1

1

Set Motion Control Parameters

2 Set Pitch 1.0

Perimeter with Center Matrix

When Equipped with SCS-UK1

1

Set Motion Control Parameters

2 Set Pitch 1.0

7

Move crosshair laser to Start Location

8

Save Start Location

9

Go to Thermal Profile Screen

10

If desired, select Auto Profile

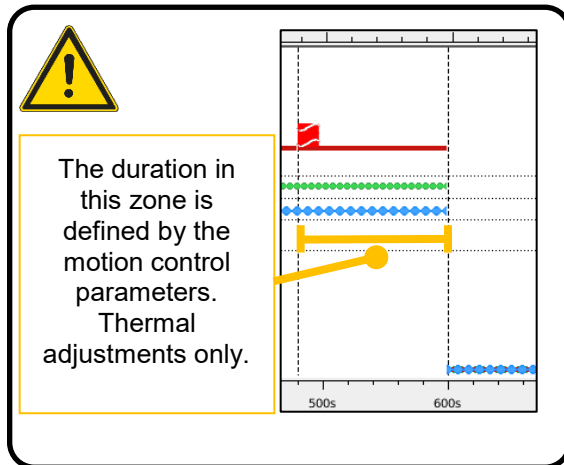
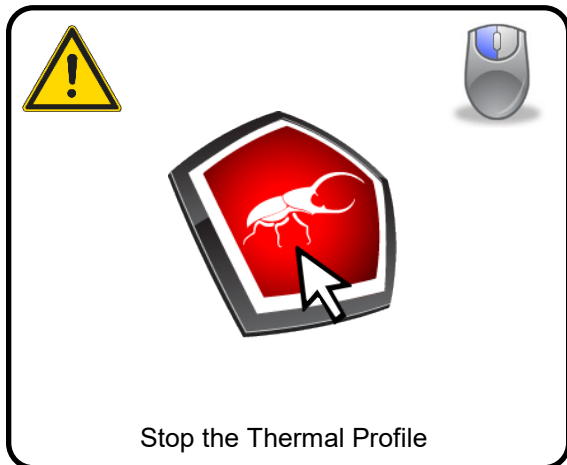
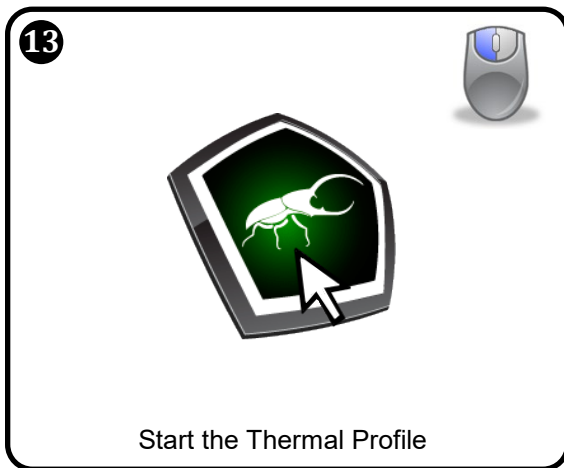
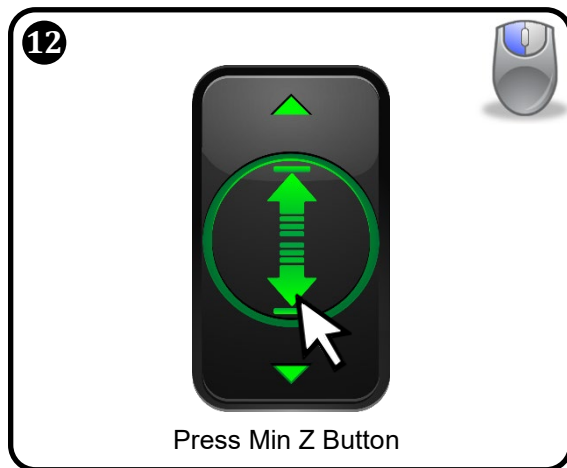
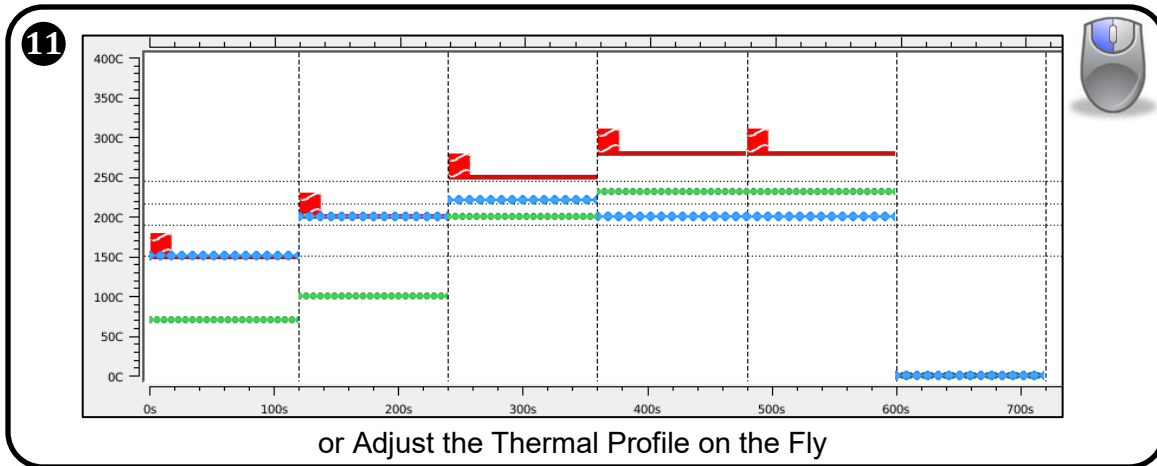



Open/Import Profile

1

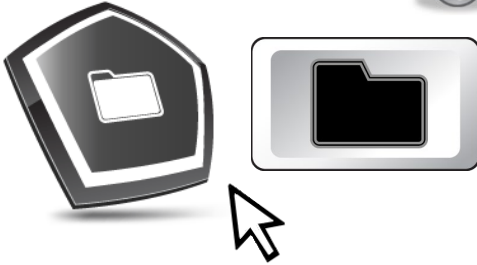

Press the Open Profile Icon

2

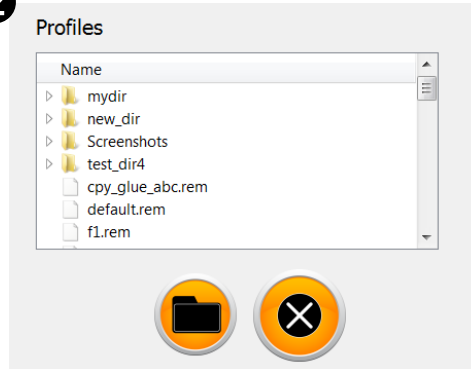

Select the File

3



Press the Open Icon



Cancel the Selection



Save Profile or Create Directory

1

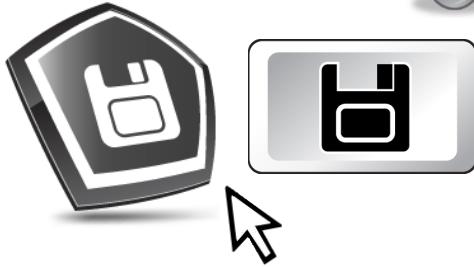

Press the Save Icon

2



Name the File & Select Location

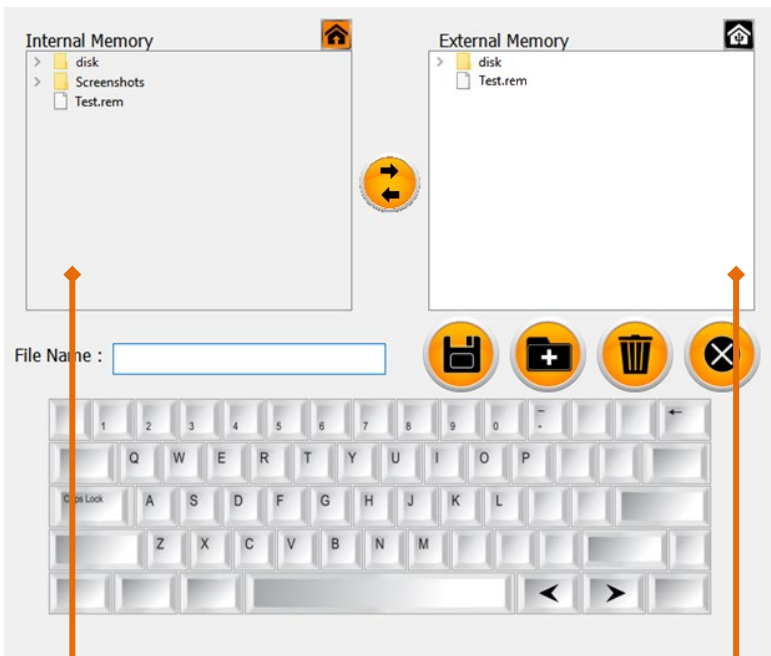

Save



Create Directory



Delete



Cancel

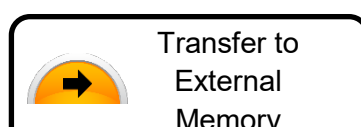

Transfer to External Memory



Transfer to Internal Memory



Internal Memory Location



External Memory Location, when available



Using a Saved Cleaning Profile

1

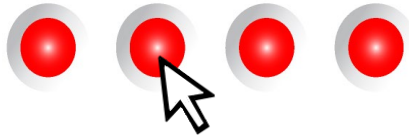

Go to Motion Control Screen

2



Press Home Button

3

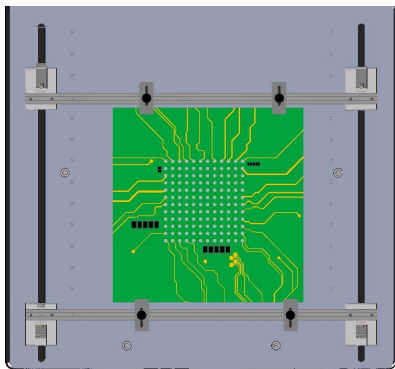

Load PCBA into Board Holder

4

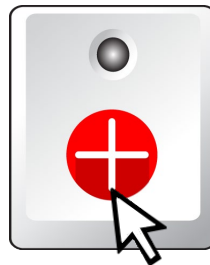

Activate Laser Crosshair

5

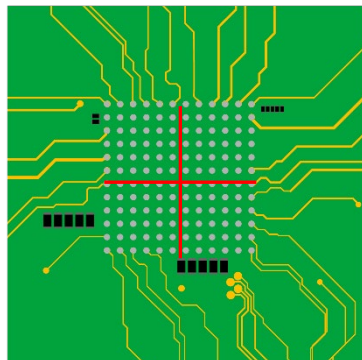

Center pad area over the preheater using crosshair laser



APR recommends using a fixture to maximize repeatability of the motion and thermal profiles.

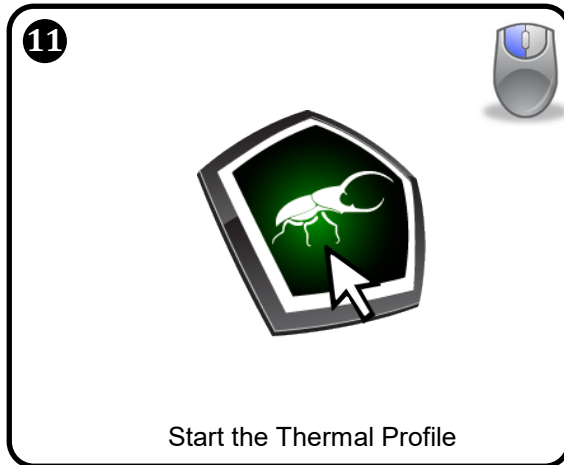
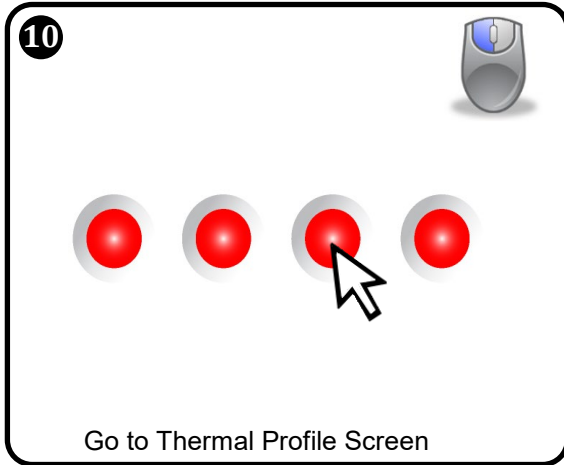
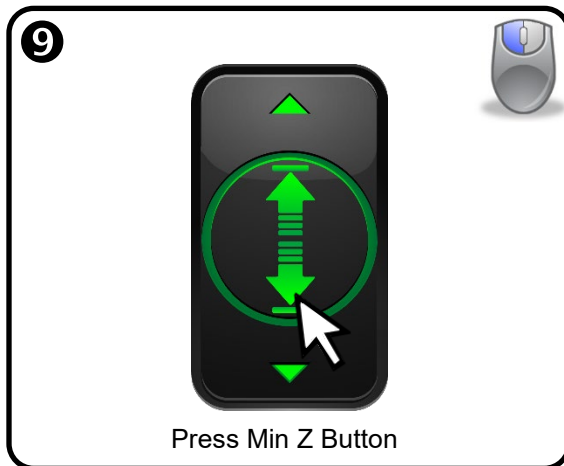
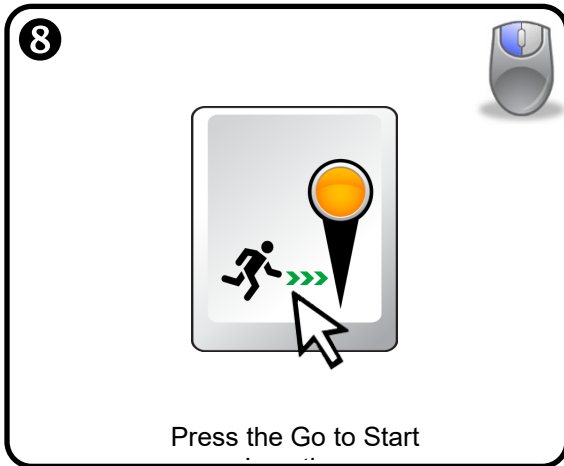
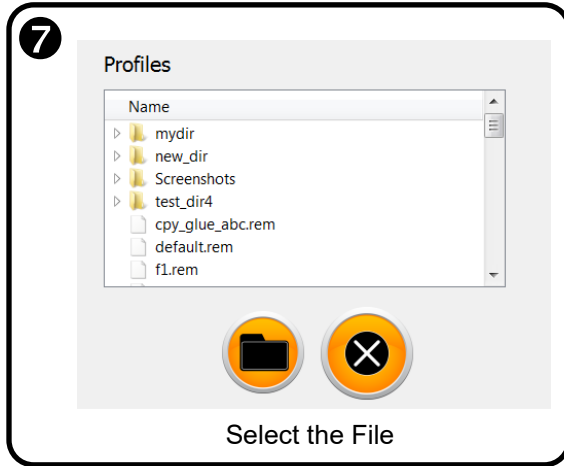
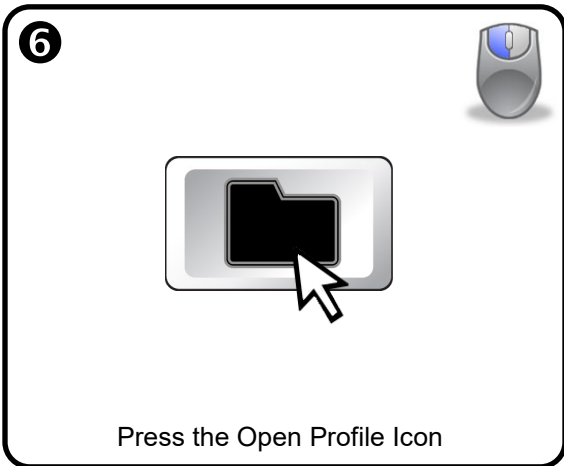



Auto-profile

- A tool used to assist in the creation of thermal profiles.
- A thermocouple trigger is used to control the actions of the Scarab.



Start with the New Cleaning Profile instruction

1

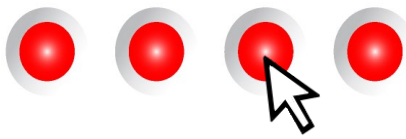

Go to Thermal Profile Screen

2



Select Auto Profile
1st click – lead free
2nd click – lead profile
3rd click – exit auto-profile

3

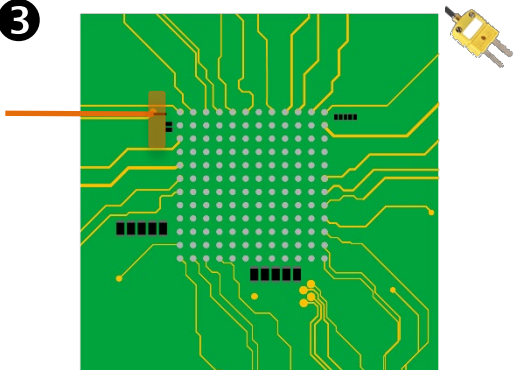

Attach thermocouple near start position on PCBA

4

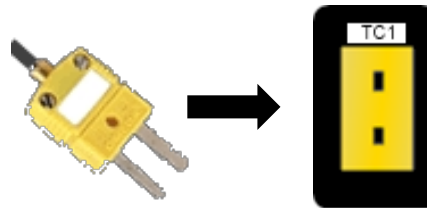

Connect thermocouple to TC1

5



Start the ThermalProfile



Collection Chamber Cleaning

1

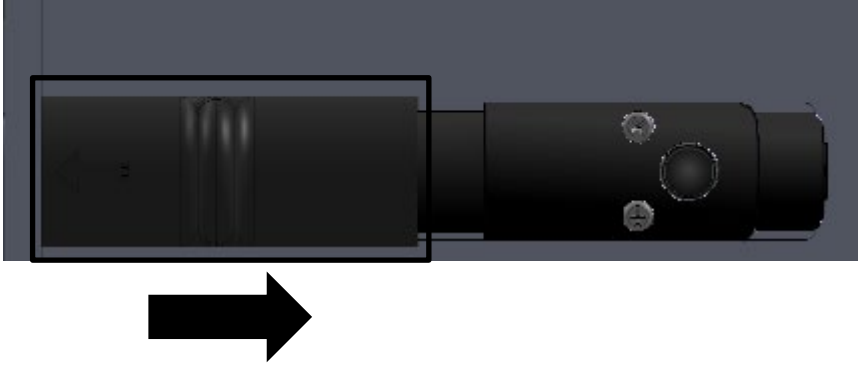

2

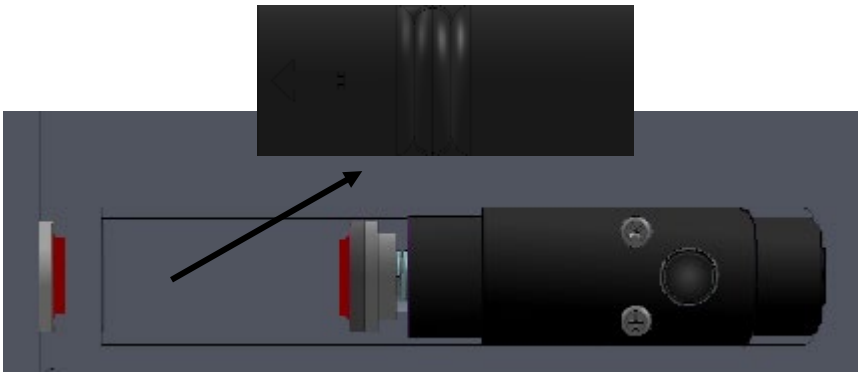

3

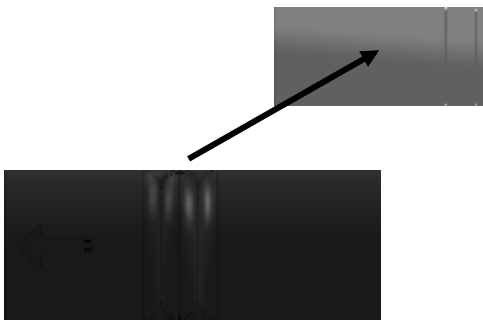

4

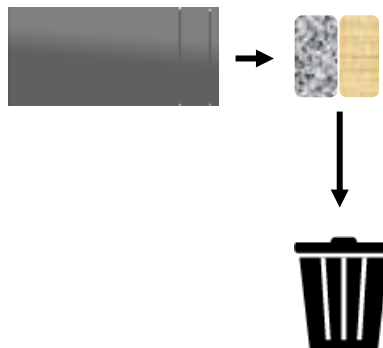

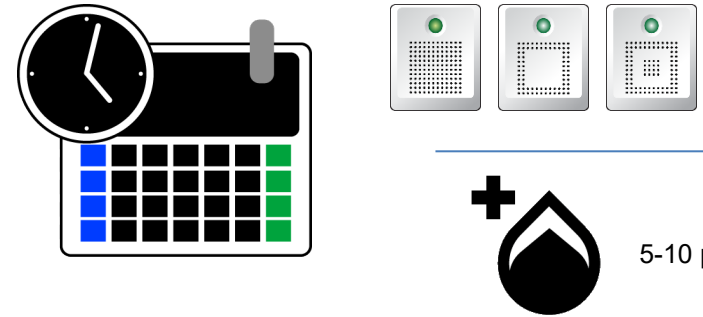
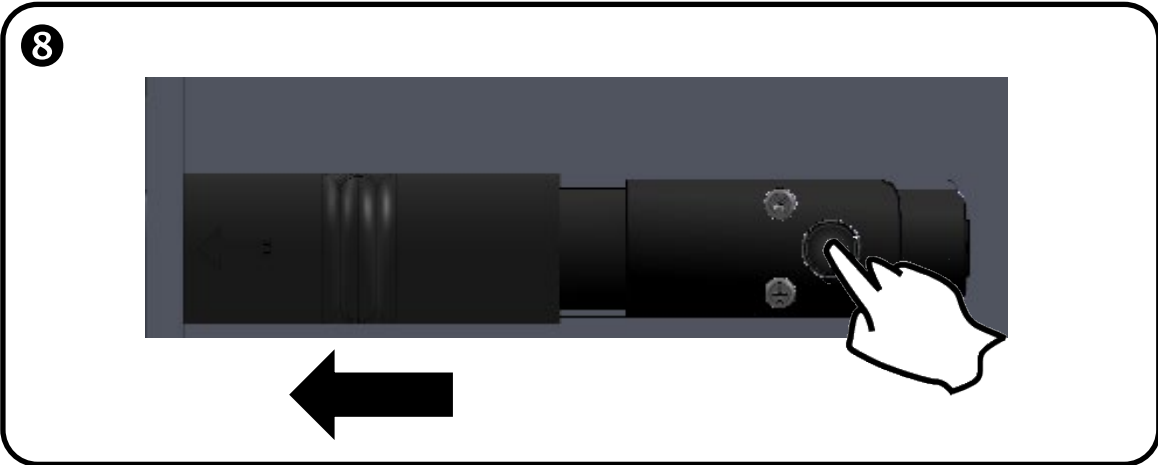
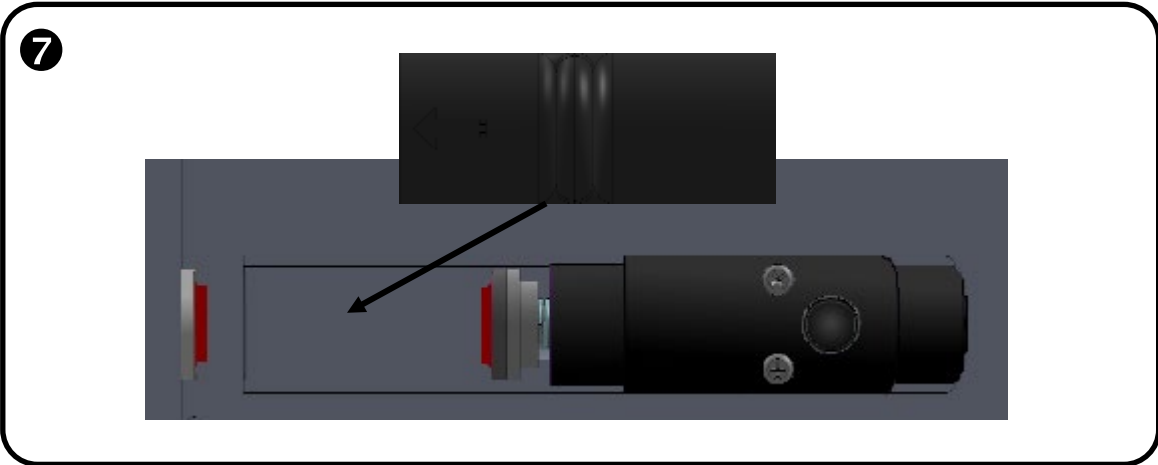
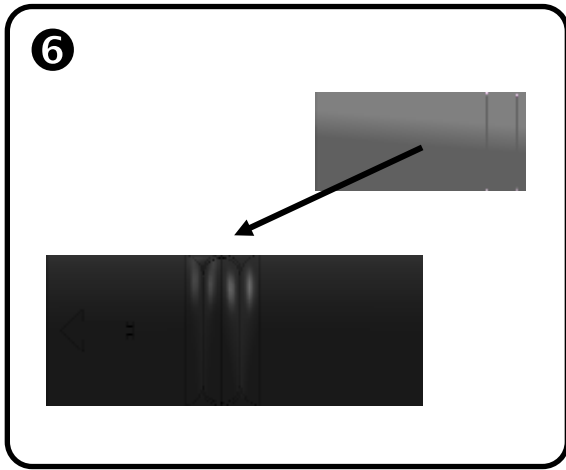
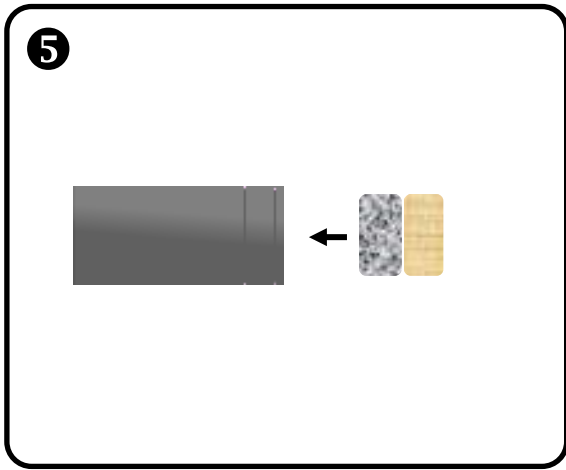

Daily or as needed

5-10 parts or as needed



Data Backup

1



Insert a USB flash drive with a 2GB or greater capacity into the USB connector

2

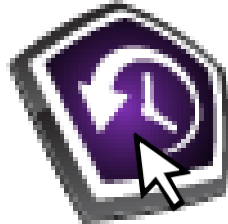

Left click the Data Backup Button

3

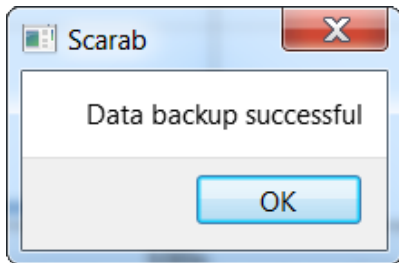



Data Restore

1



Right click the Data Backup Button

2

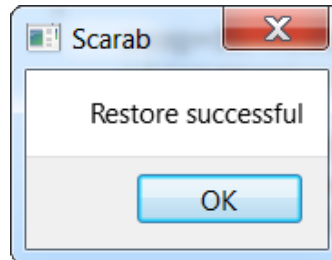

3



Remove a USB flash drive with a 2GB or greater capacity from the USB connector



Capture Screen Shot

1



Press the Screenshot Icon

2

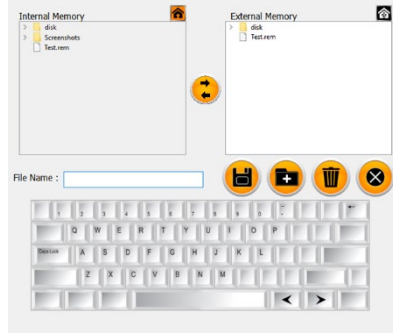

Name the File & Select Location

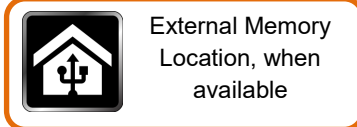
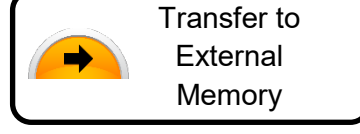
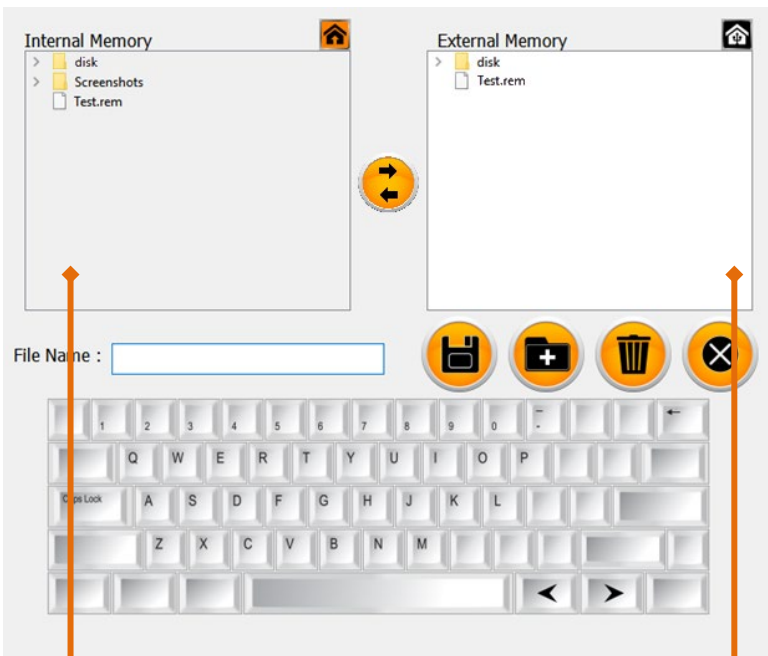



Load Screen Shot

1



Press the Save Icon

2

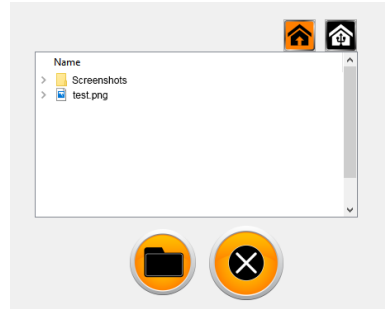

Select File



Create Directory



Cancel

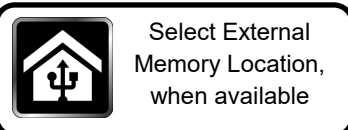

Select External Memory Location, when available



Select Internal Memory Location



Ethernet Connection & File Management

1



Load or Open the APR Connect software

2

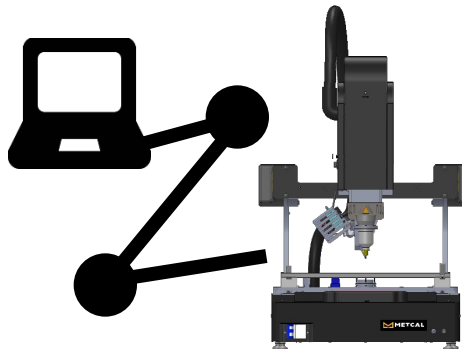

Connect the system to the network

3

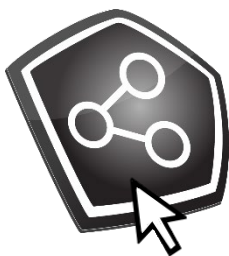

Press the Ethernet Icon

4

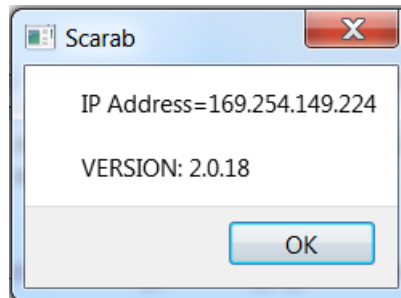

Record the IP Address

5

Enter the IP Address

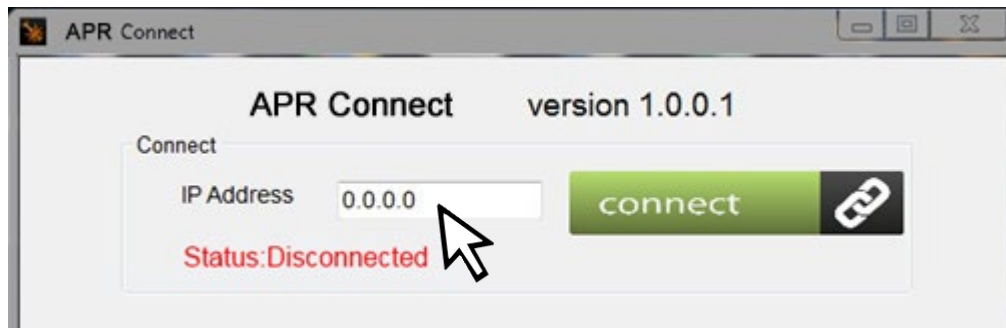

6

connect

Press the Connect Button

Connect

IP Address 172.16.00.14

Status: Connected

profile

Press the Upload Profile Button to transfer files to the Scarab Site Cleaning System

software

Press the Software Button to transfer new software to the Scarab Site Cleaning System

manual

Press the Manual Button to transfer a new manual to the Scarab Site Cleaning System

tool tips

Press the Tool Tips Button to transfer updated tool tips to the Scarab Site Cleaning System

profile

Press the Download Profile Button to transfer files from the Scarab Site Cleaning System

7

Press the Disconnect Button

APR Connect

version 1.0.0.1

Connect

IP Address 111.111.111.111

disconnect

Status: Connected

Calibration & Adjustment



Recommended Maintenance Schedule



Required Calibration & Adjustment Tools

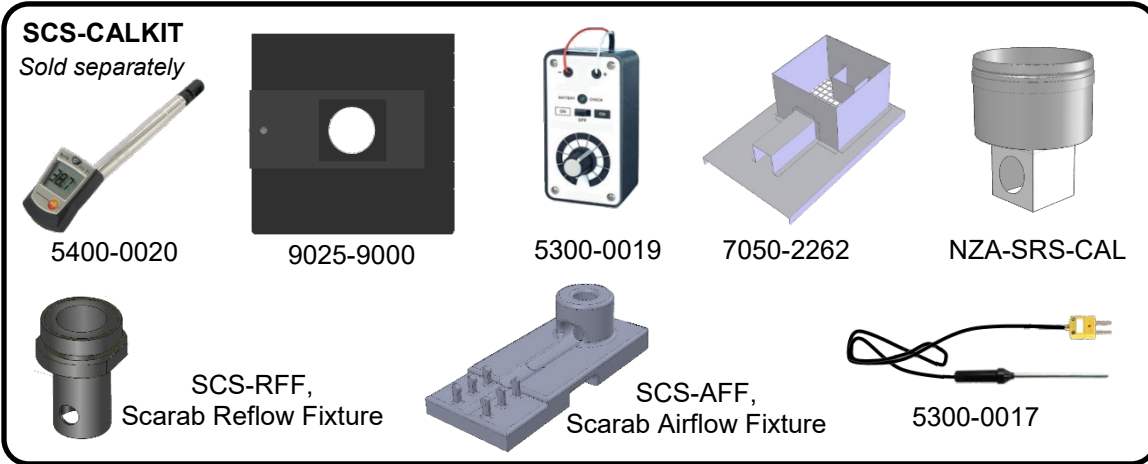
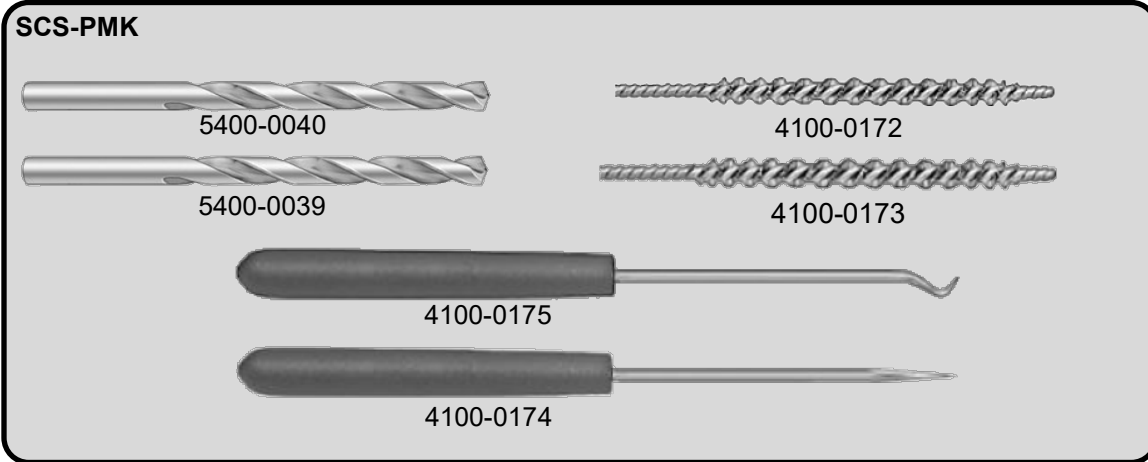
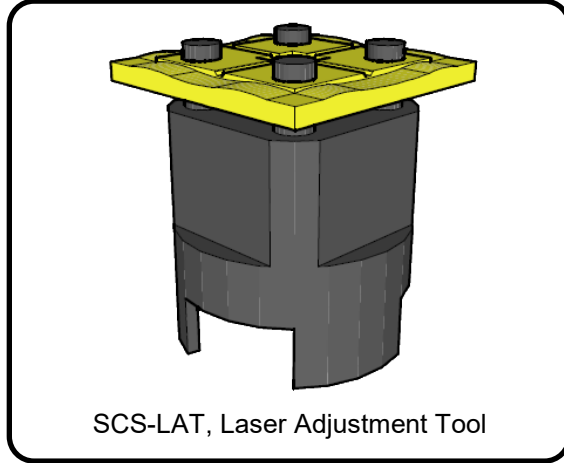
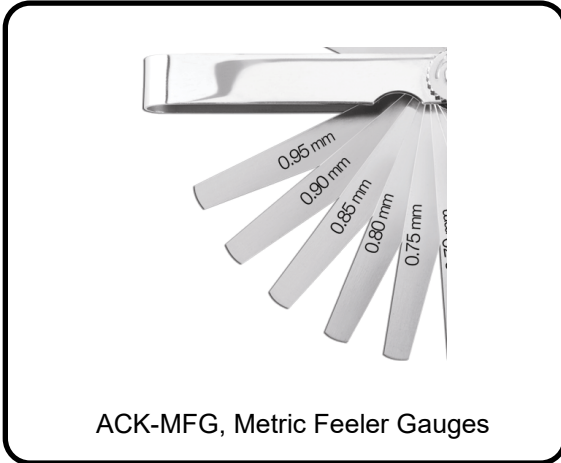



Setting the Home Position

1

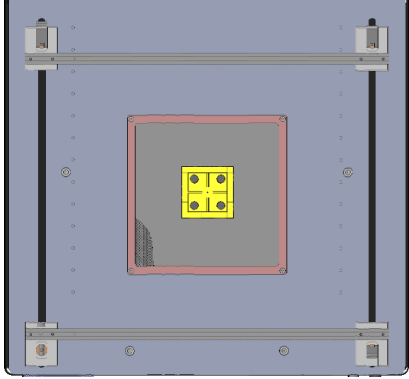

Install the Laser Adjustment Tool (SCS-LAT)

2

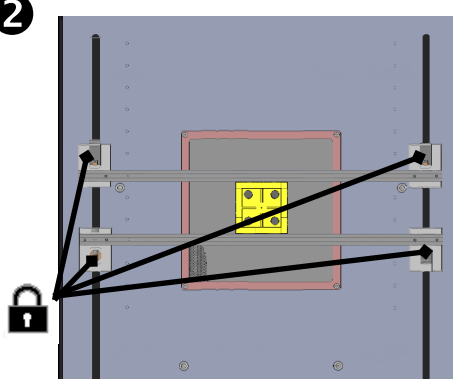

Lock the SCS-LAT into place

3



Move the vacuum nozzle to a spot roughly centered over the SCS-LAT

4

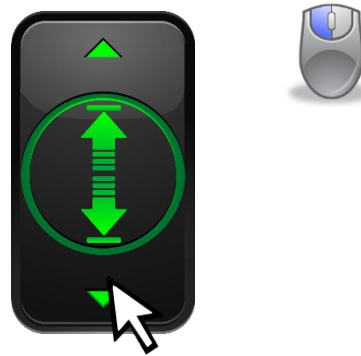

Manually drive head down until nozzle is approximately 2mm above SCS-LAT

5



Center the vacuum nozzle over cone at the center of the SCS-LAT

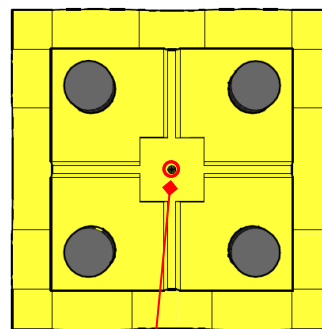

Top View

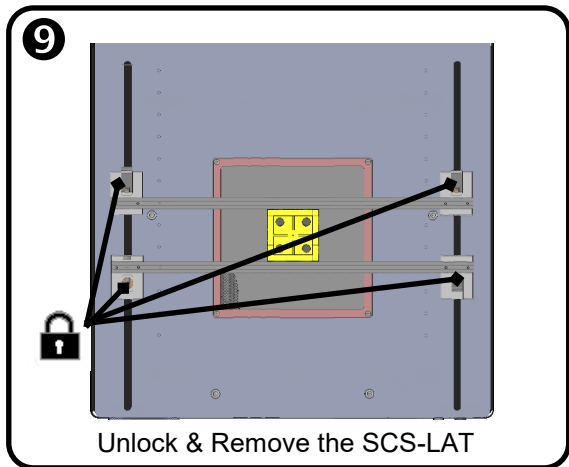
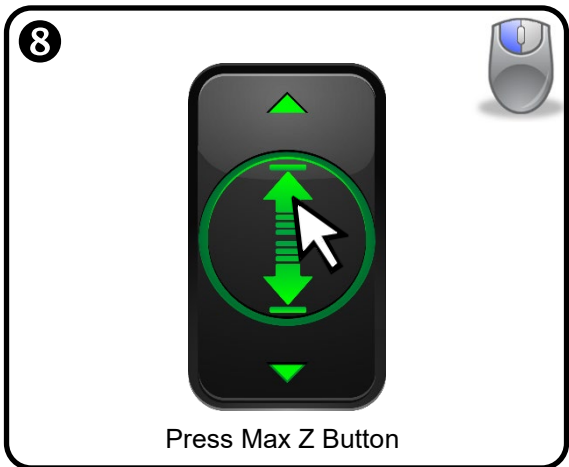
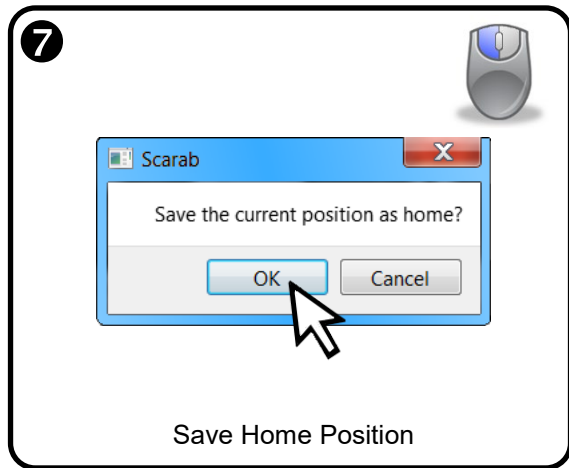
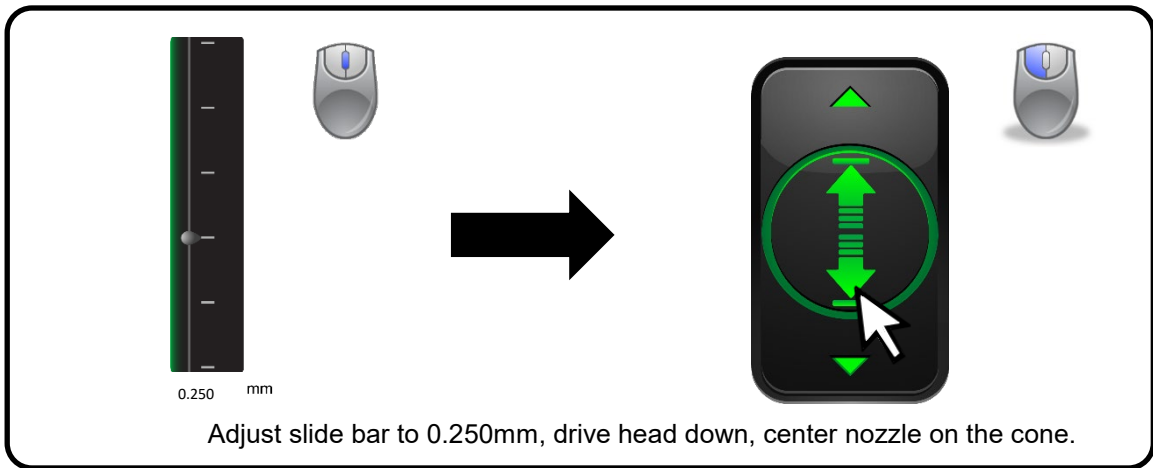



Crosshair Laser Setup

1

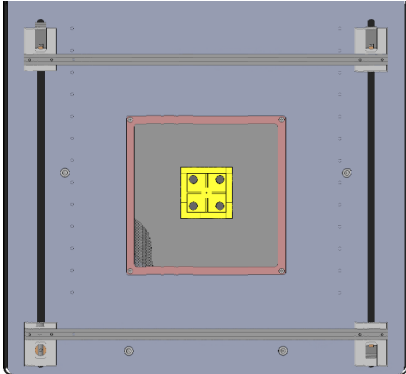

Install the Laser Adjustment Tool (SCS-LAT)

2

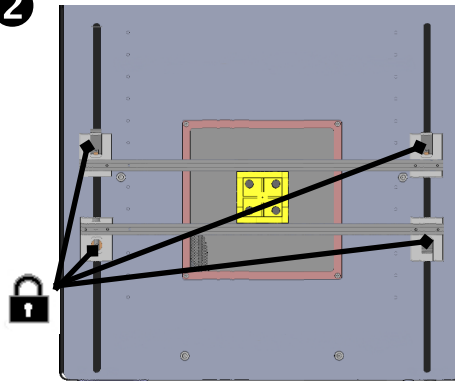

Lock the SCS-LAT

3



Press Home Button

4

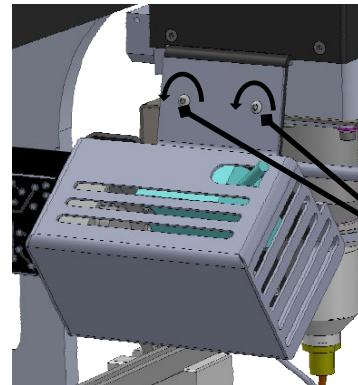

Remove the laser assembly cover

5

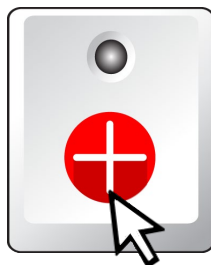

Activate Laser Crosshair

6

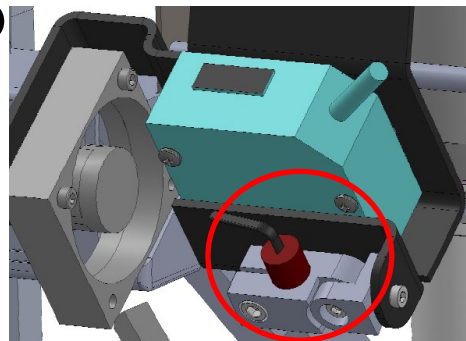

Adjust the crosshair laser (SCS-CALM). Ensure the laser is flush with the bottom of the bracket



Laser Radiation Warning
Do not stare into the beam or view directly with optical instruments.
Laser components are sealed and replaced in their entirety.

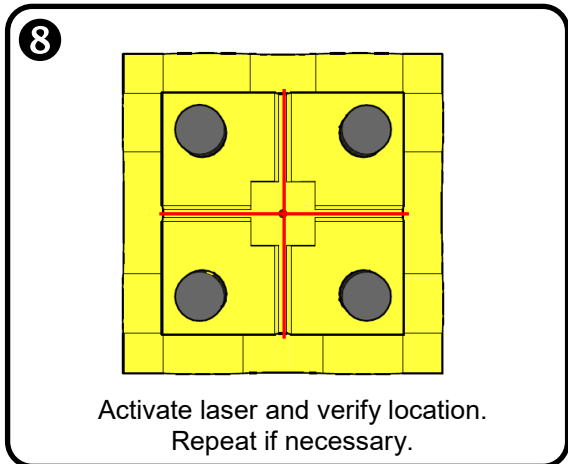
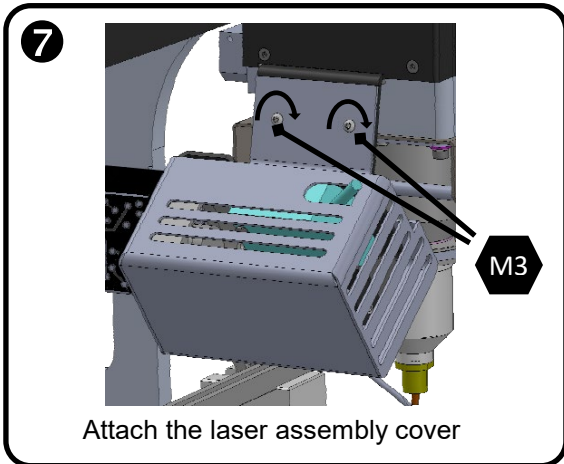
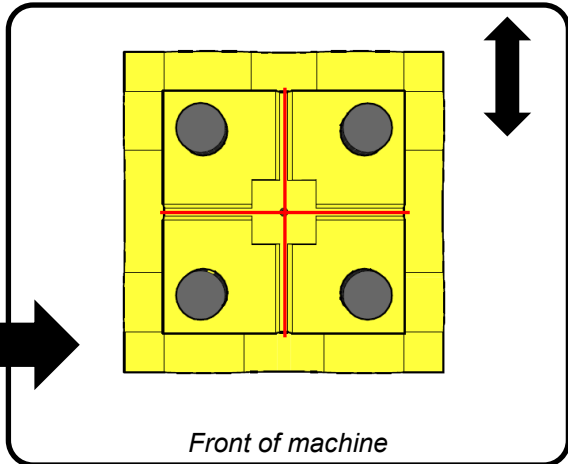
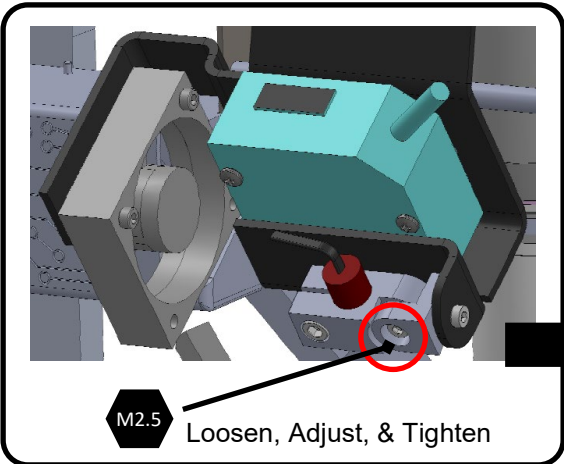
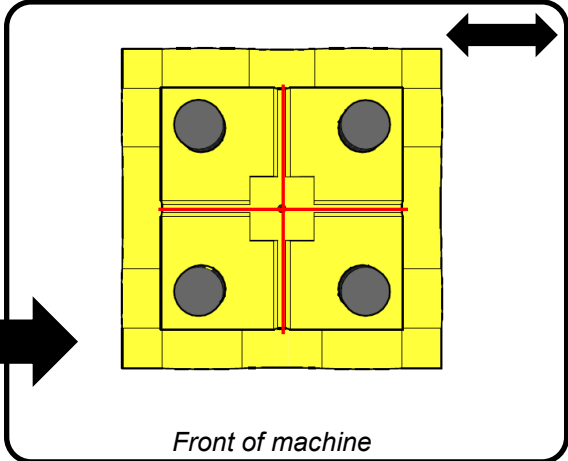
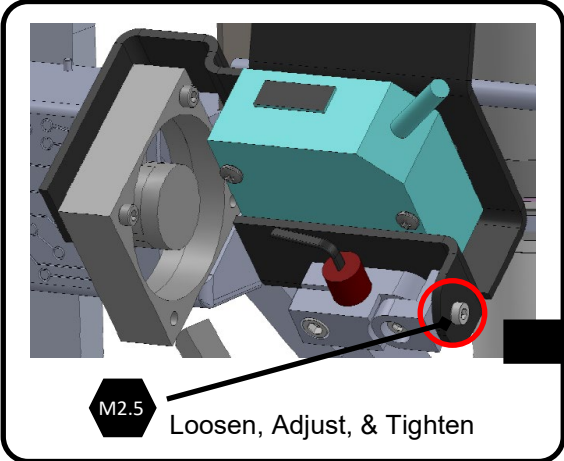
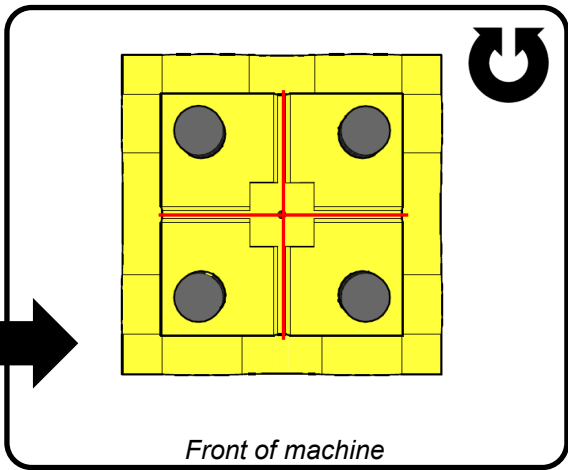
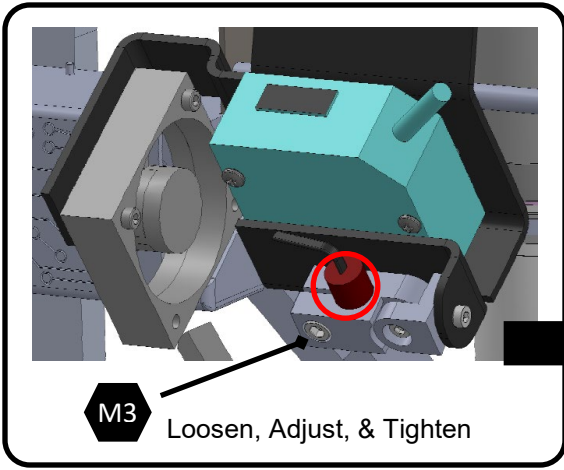



Calibrating the Laser Height Sensor (SCS-HSLM)

1



Press Home Button

2

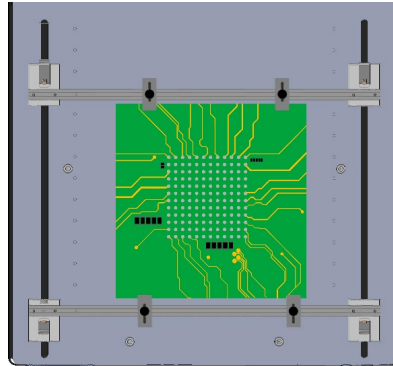

Load PCBA into Board Holder

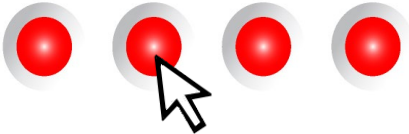

Go to Motion Control Screen

4



Jog head to right limit



Press Min Z Button



The reflow head is stopping below the normal height, please check if PCBA is correctly loaded.

OK



Laser Radiation Warning
Do not stare into the beam or view directly with optical instruments.
Laser components are sealed and replaced in their entirety.

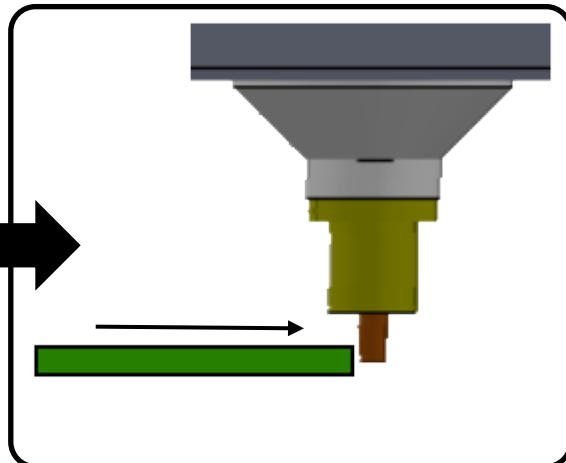
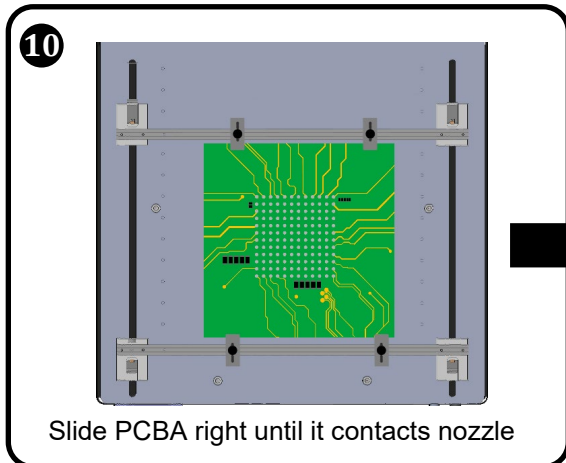
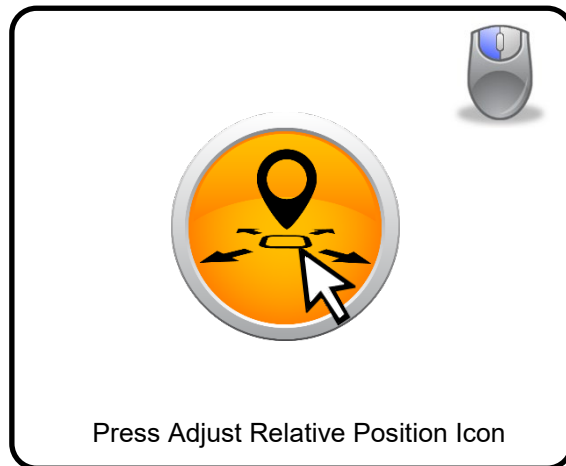
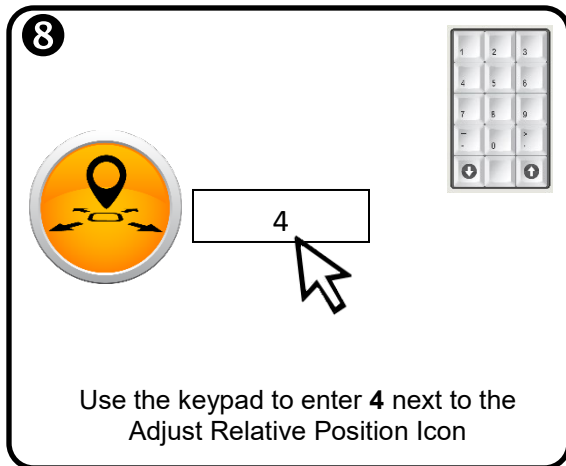
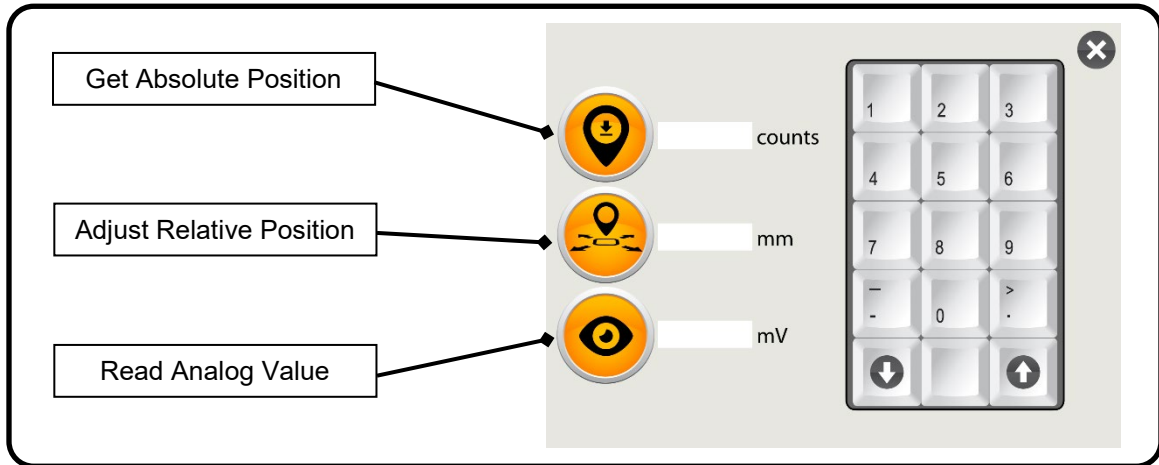
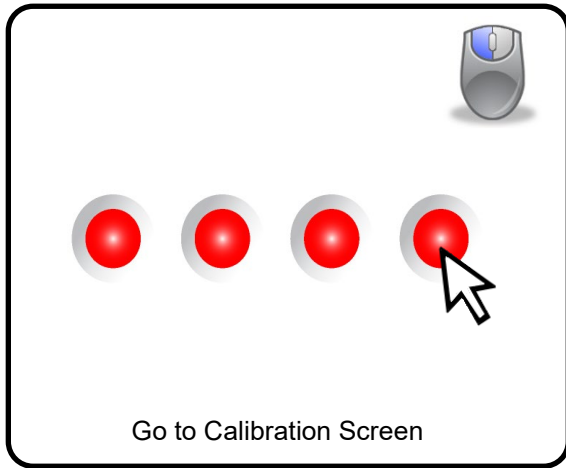

11

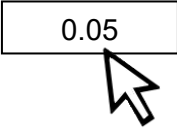





0.05

Use the keypad to enter **0.05** next to the Adjust Relative Position Icon

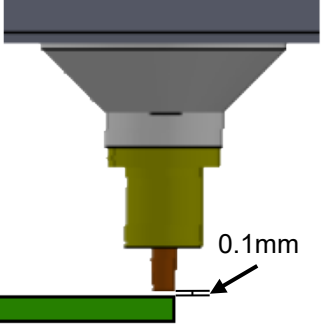

Press Adjust Relative Position Icon







0.95 mm
0.90 mm
0.85 mm
0.80 mm
0.75 mm

0.1mm

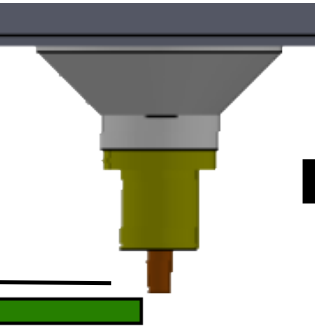

>0.1mm





Press and Hold. Repeat **10**

12



Press Save Work Surface Location Icon



“Has the vacuum nozzle been positioned 0.1mm above the reference?”

YES



"Click yes to save the current position as the plane of operation."

YES

Part 2

13

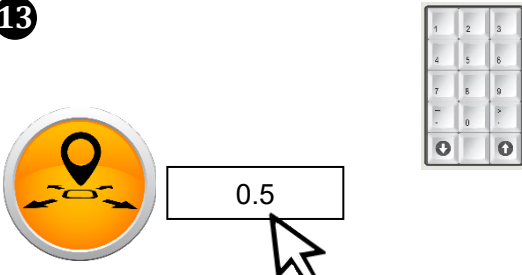

0.5

Use the keypad to enter **0.5** next to the Adjust Relative Position Icon

14



Press Adjust Relative Position Icon

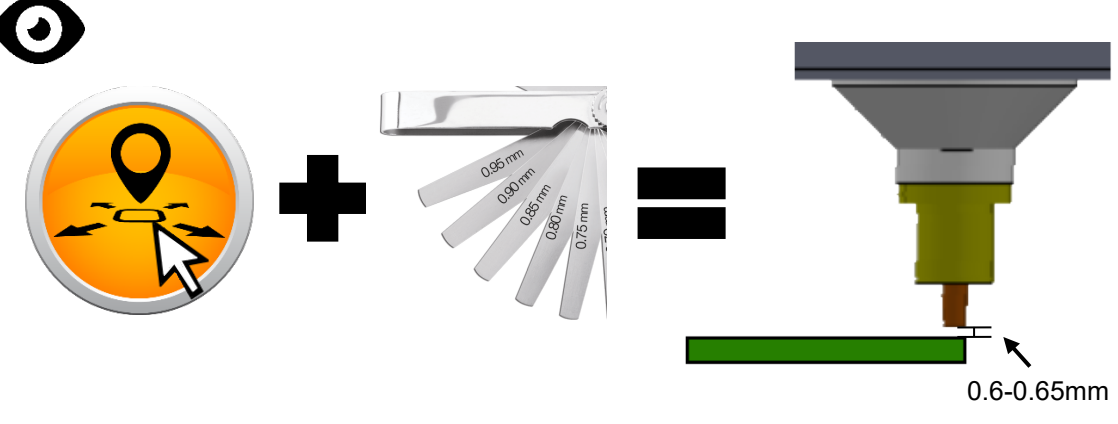

0.6-0.65mm

15

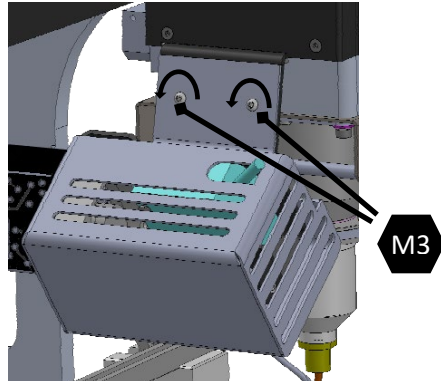

M3

Remove the laser assembly cover

16

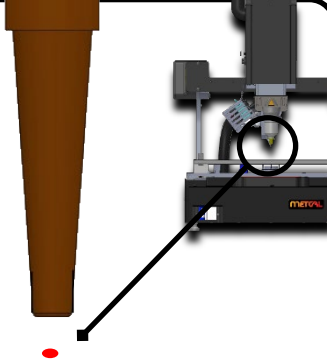

Verify laser position, center of nozzle

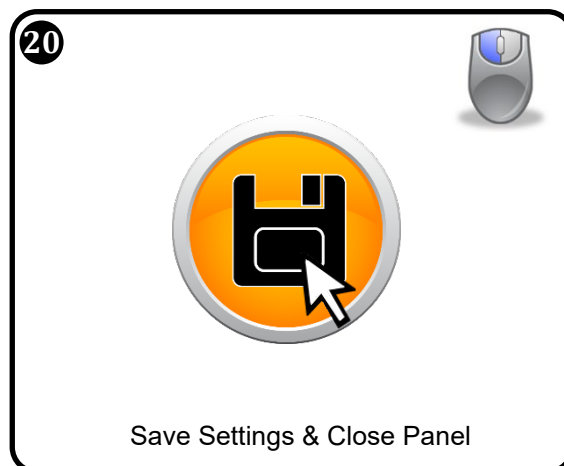
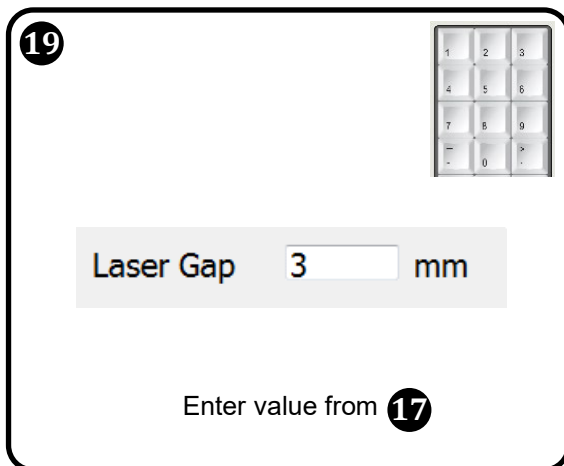
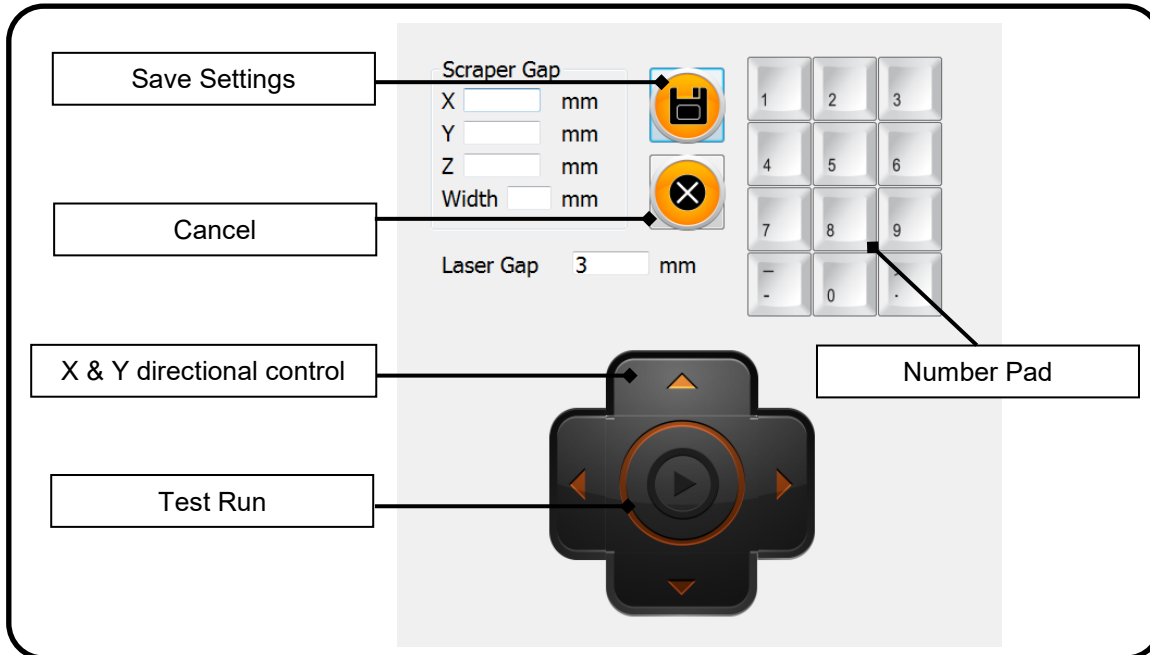
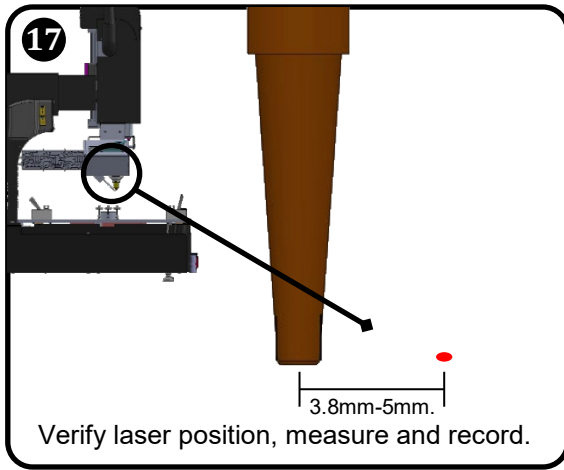

Laser Radiation Warning
 Do not stare into the beam or view directly with optical instruments.
 Laser components are sealed and replaced in their entirety.

21



Press Motion Control Icon

22





Press Get Absolute Position Icon & Record the Value

23



Press Read Analog Value Icon & Record the Value

24

Use the keypad to enter **0.6** next to the Adjust Relative Position Icon

25



Press Adjust Relative Position Icon

26

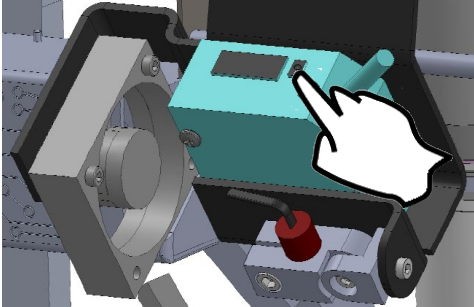

Press and hold the TUNE button for 3 sec until "TUNE" blinks, then release

27

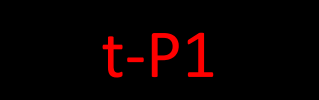

"t-P1" appears

28



Press Up button for 3 sec

29 

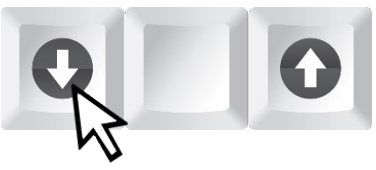

Press Down button until motor stops

30 



Press Get Absolute Position Icon

31

22  5000

30  5000 ±75

Compare Get Absolute Position from step 22 to Get Absolute Position from step 30

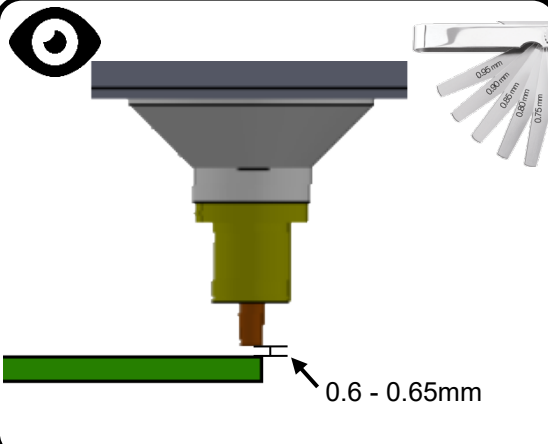

0.6 - 0.65mm

32 



Press Read Analog Value Icon & Record the Value

33

23  3000

32  3000 ±8

Compare Read Analog Value from step 23 to Read Analog Value from step 32





 Step 22 = Step 30 ±75

 Step 23 = Step 32 ±8

Calibration Complete



 Step 22 ≠ Step 30 ±75

 Step 23 ≠ Step 32 ±8

Repeat 13



External Thermocouple Calibration

- Required:
- K type thermocouple simulator

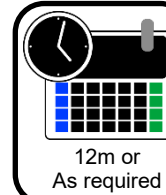

K type thermocouple tester

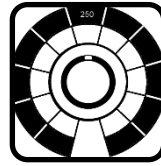

Set knob to 250°C



1



- Left click the thermocouple calibration icon

2



- The current temperature will be displayed

3



- Plug the K type thermocouple tester into the matching external thermocouple connector

4



- Right click the thermocouple to calibrate selected thermocouple.

5



- The current temperature will be displayed
- Left to cycle to next thermocouple
- Repeat until each thermocouple has been calibrated.



Reflow Blower Calibration Setup



5400-0020

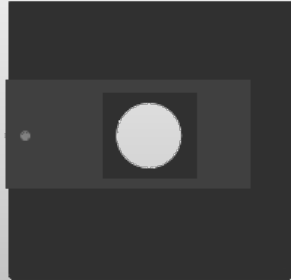

9025-9000

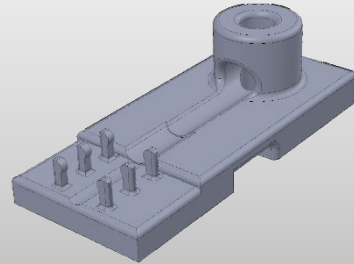

SCS-AFF

1

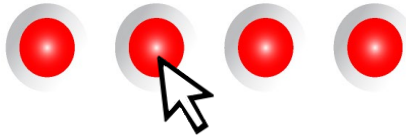

Go to Motion Control Screen

2



Press Home Button

3



Attach SRN-11 to nozzle assembly

4

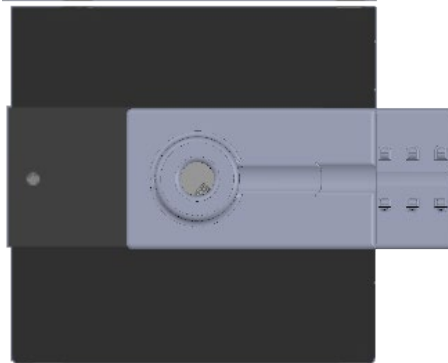

Load SCS-AFF onto 9025-9000

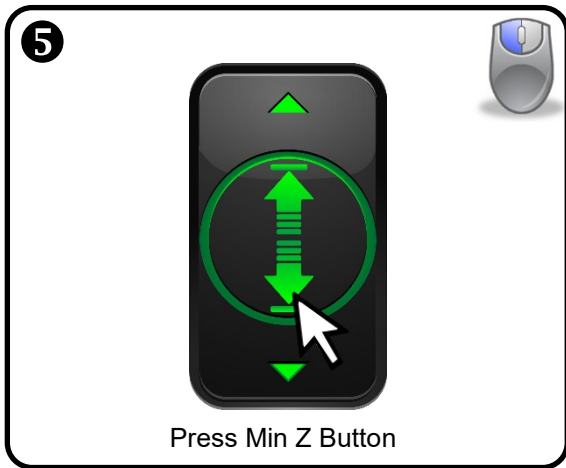

Press Min Z Button

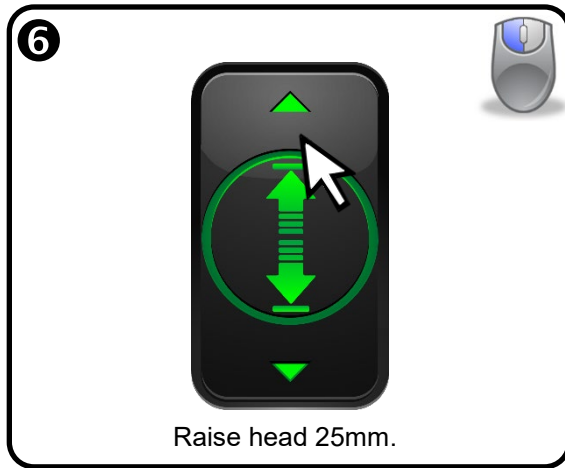

Raise head 25mm.

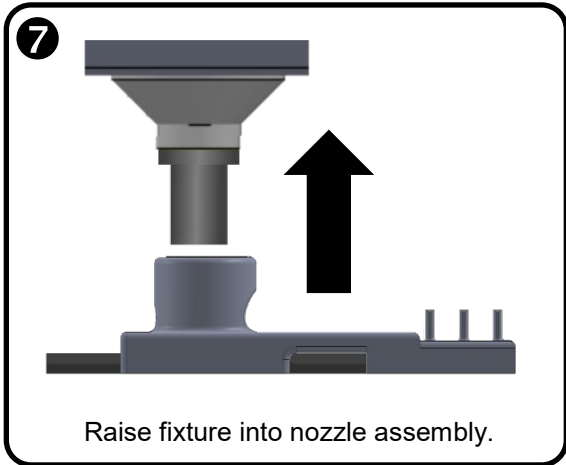

Raise fixture into nozzle assembly.

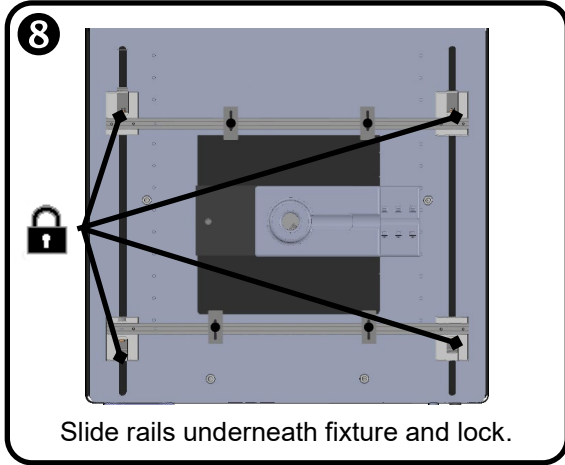

Slide rails underneath fixture and lock.

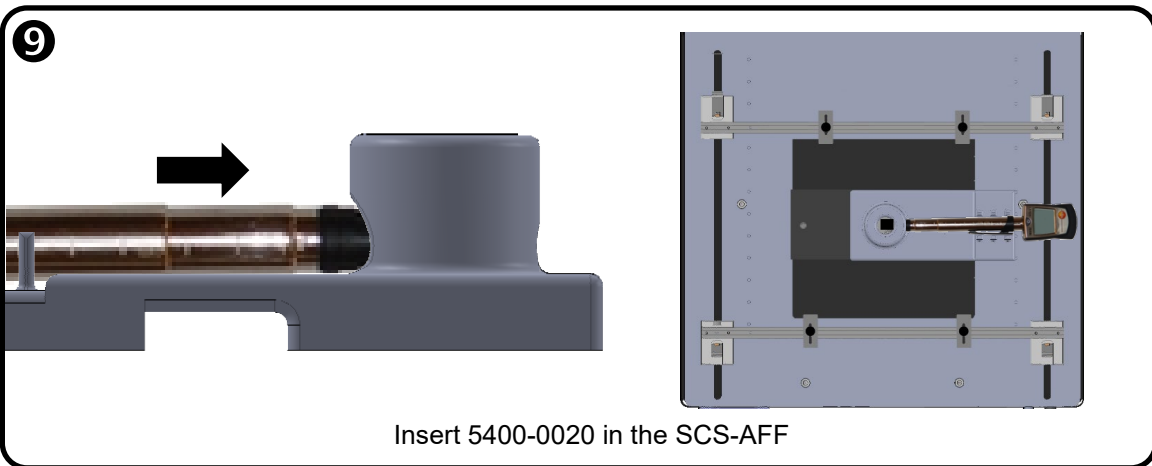

Insert 5400-0020 in the SCS-AFF

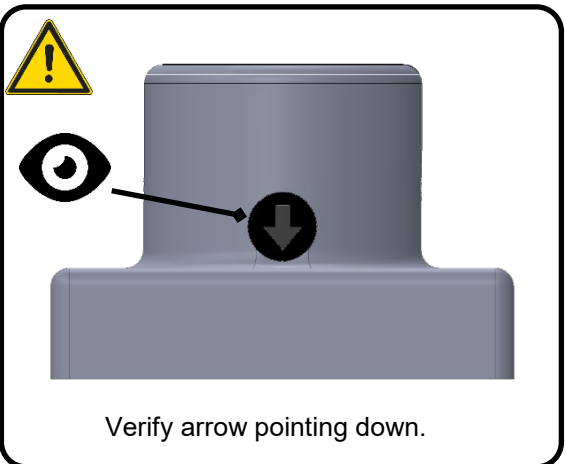

Verify arrow pointing down.

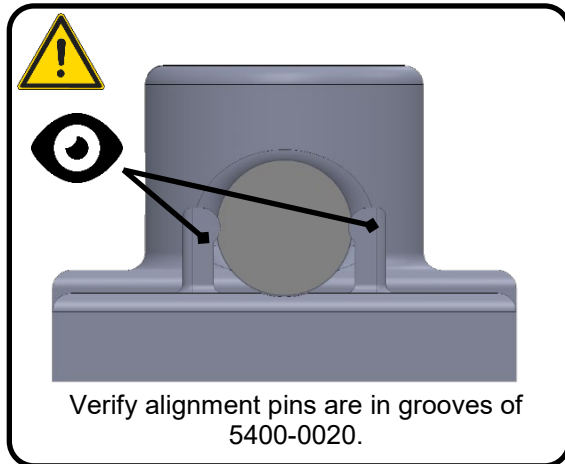

Verify alignment pins are in grooves of 5400-0020.

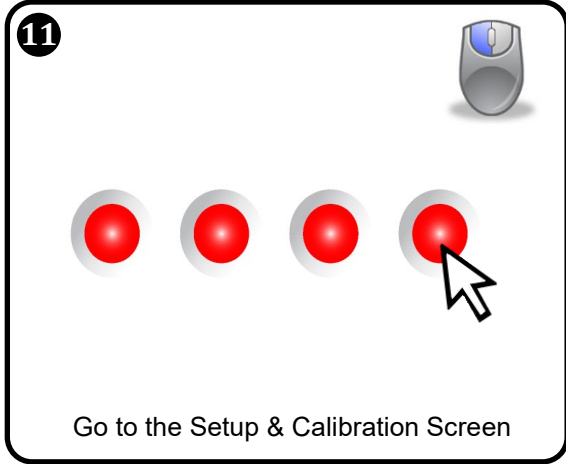

 The reflow blower has four settings: low, medium, high, and cool

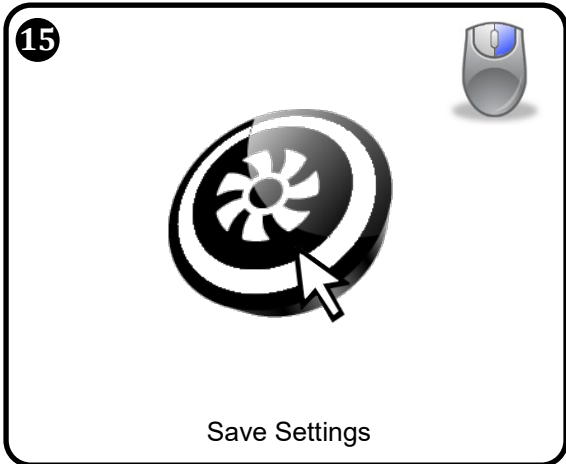
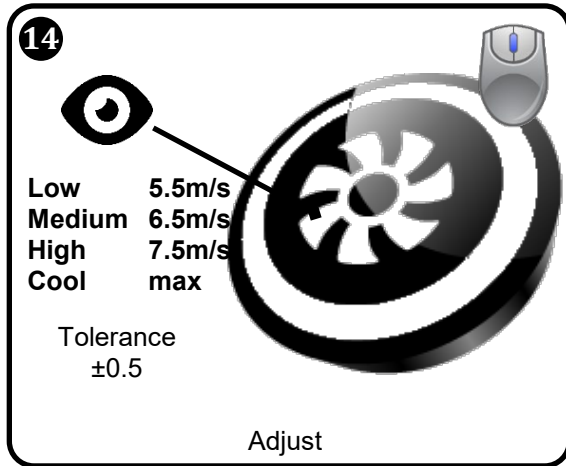
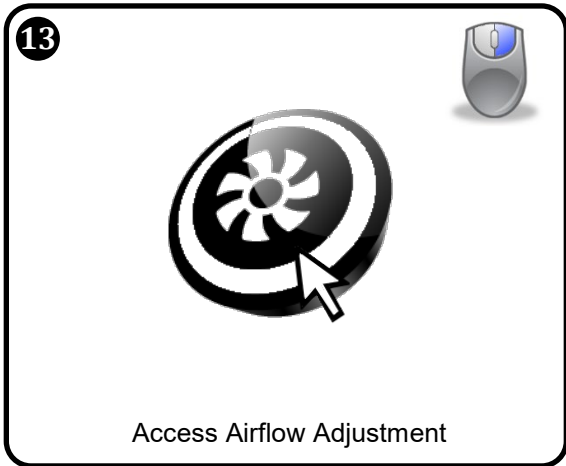
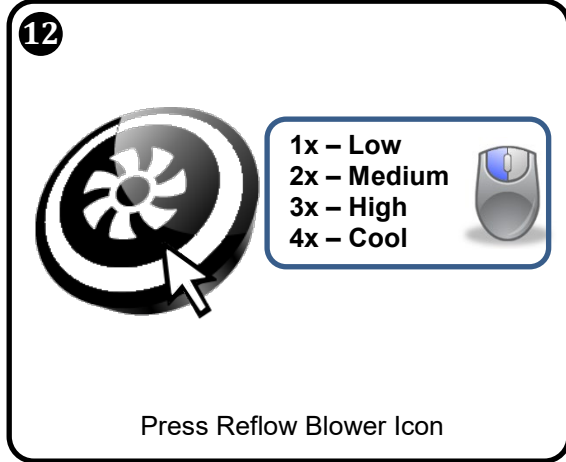



Focus Blower Setup



5400-0020

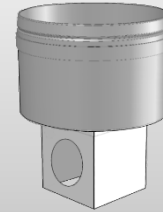

NZA-SRS-CAL

1

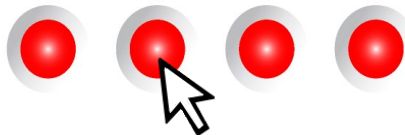

Go to Motion Control Screen

2



Press Home Button

3

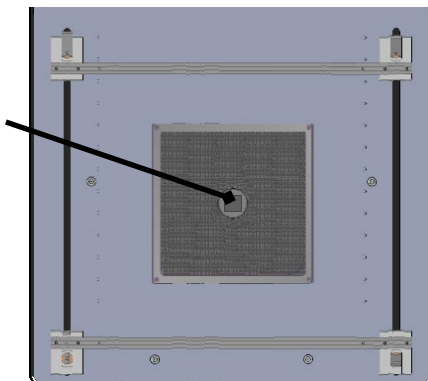

Install NZA-SRS-CAL

4

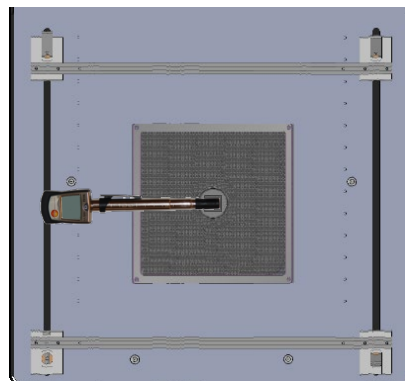

Install 5400-0020 into NZA-SRS-CAL

5

Power on the 5400-0020

6

Go to the Setup & Calibration Screen

7

Access Airflow Adjustment

The focus blower has two settings: active and cool

8

Press Reflow Blower Icon

9

Access Airflow Adjustment

10

Active 6m/s
Cool max
Tolerance ±0.2

Adjust

11

Save Settings



Surround Blower Setup



5400-0020

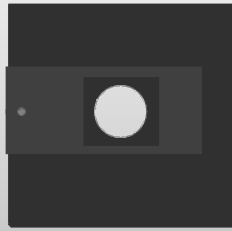

9025-9000



9025-0560

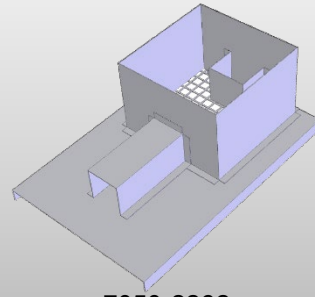

7050-2262

1

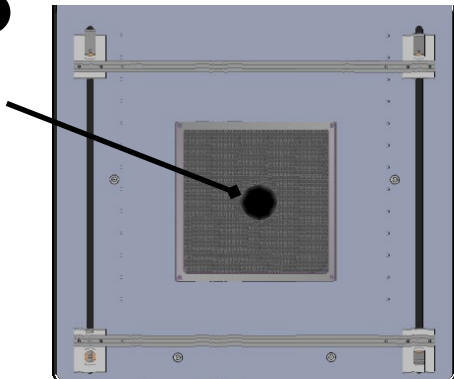

Install cover

2

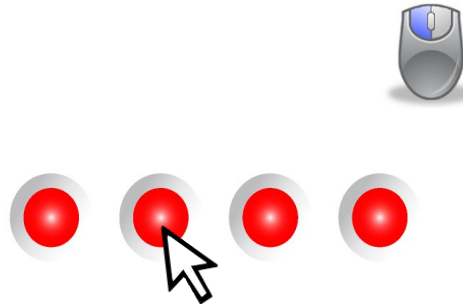

Go to Motion Control Screen

3



Press Home Button

4

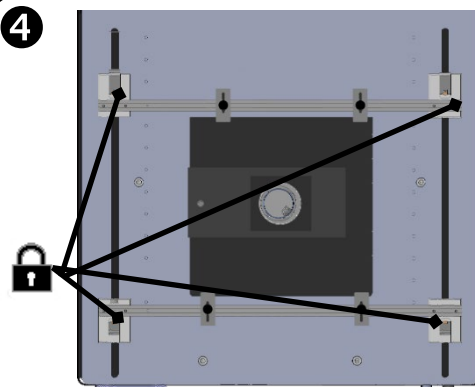

Load 9025-9000 into Board Holder

5

Load 5400-0020 into 7050-2262

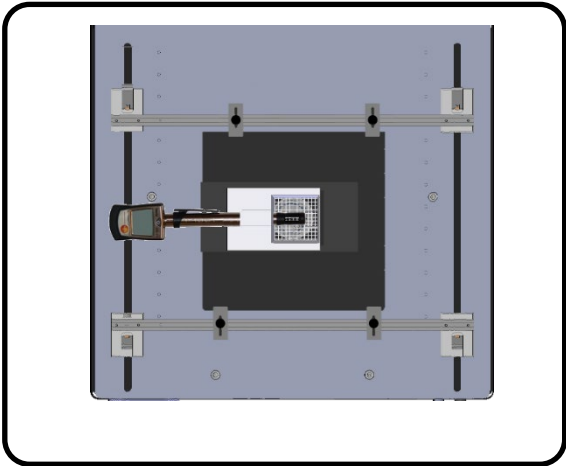

6

Power on the 5400-0020

7

Go to the Setup & Calibration Screen

8

Access Airflow Adjustment

The focus blower has two settings: active and cool

9

1x - Active
2x - Cool

Press Reflow Blower Icon

10

Access Airflow Adjustment

11

Active 2m/s
Cool 7m/s
Tolerance ±0.1

Adjust

12

Save Settings



Reflow Heater Calibration

- Required:
- Heater Calibration Kit; SCS-CALKIT

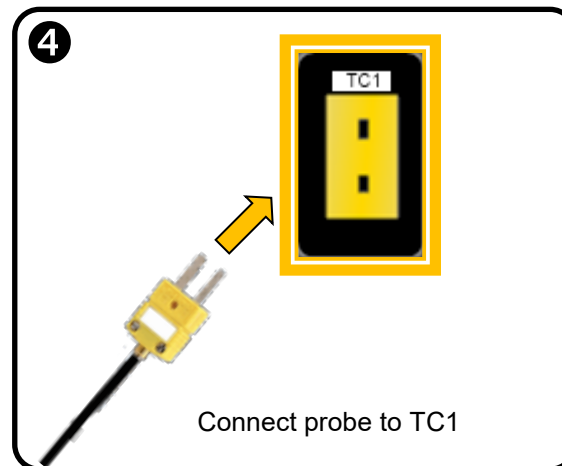
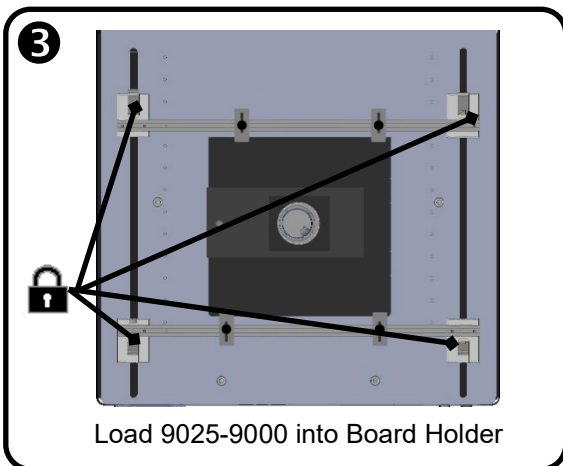
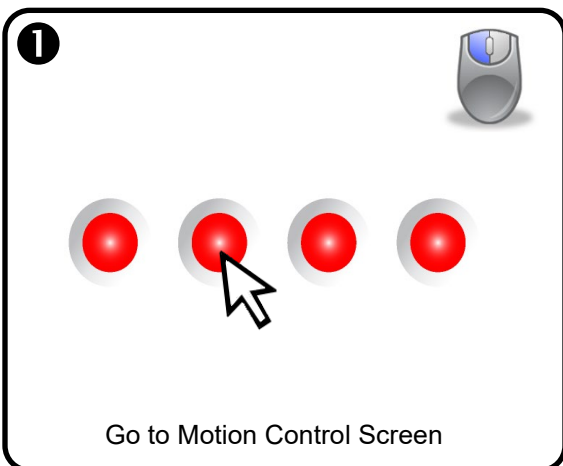
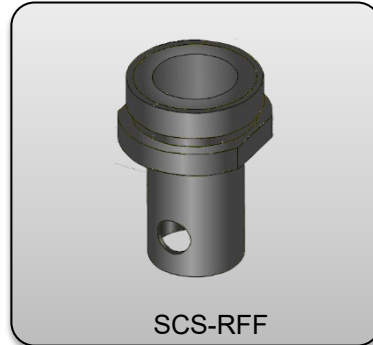
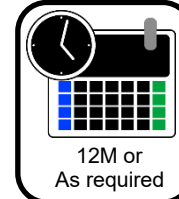

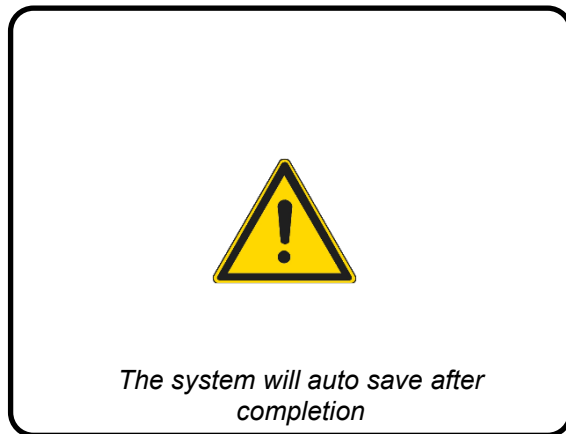
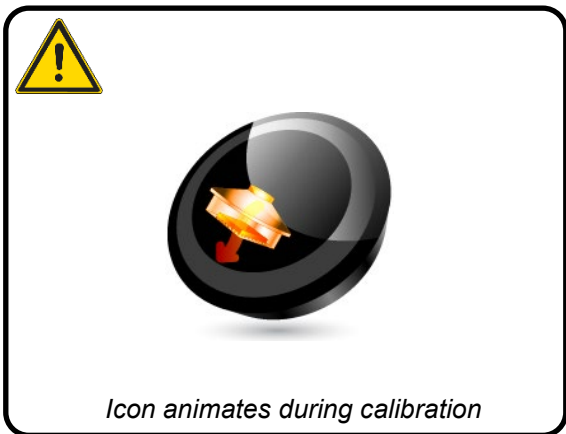
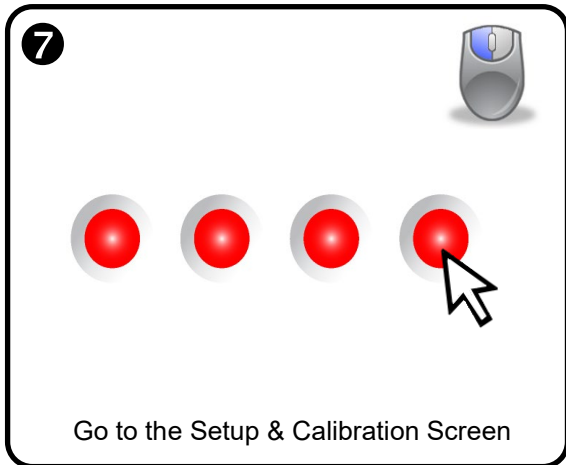
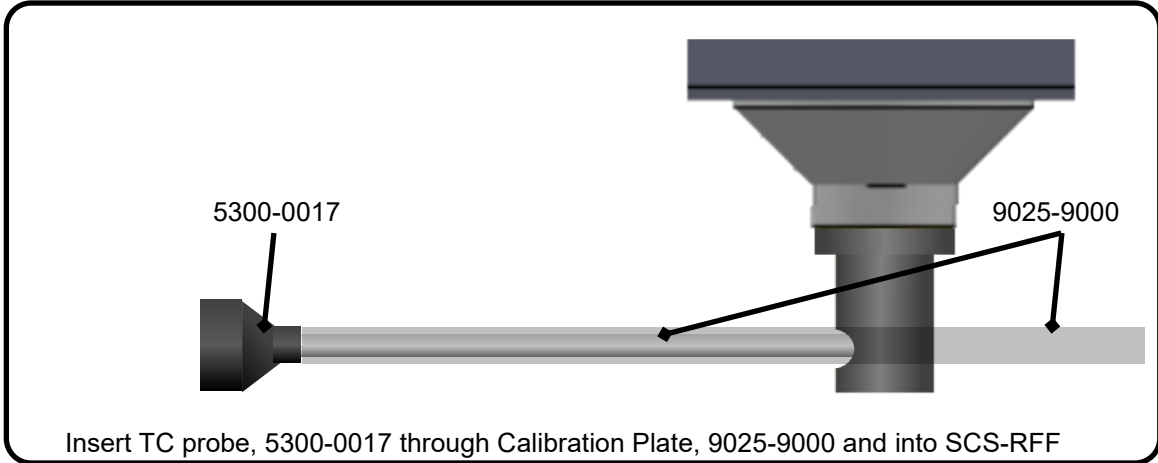
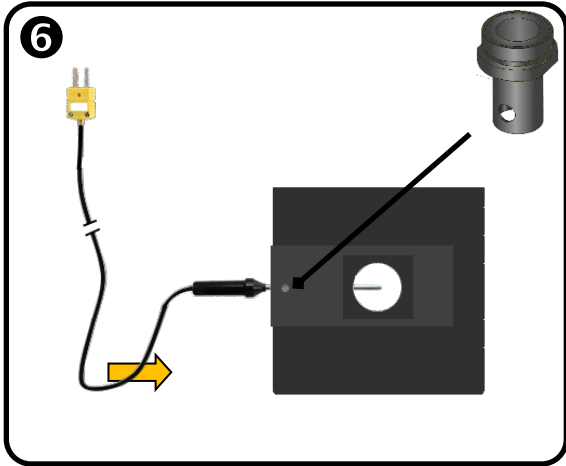
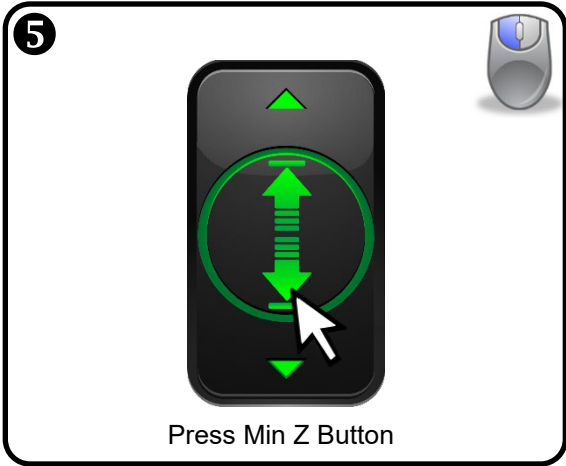



Focus Heater Calibration

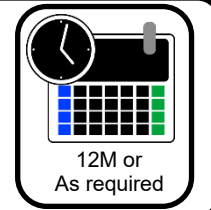

5300-0017

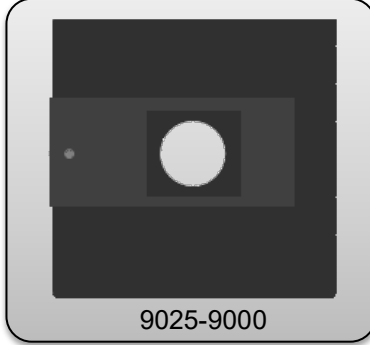

9025-9000

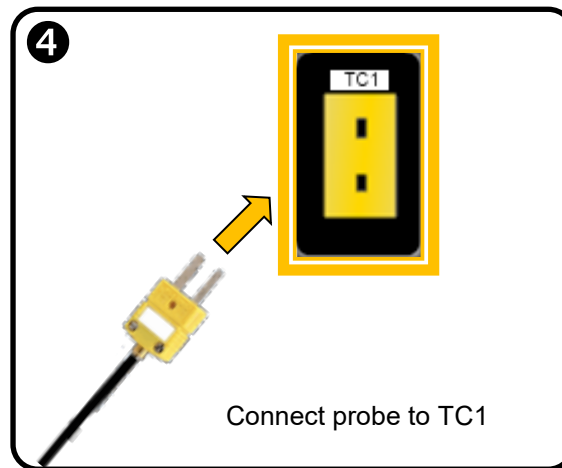
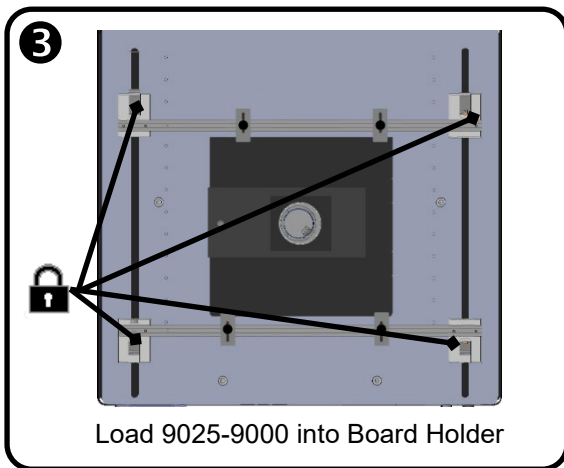
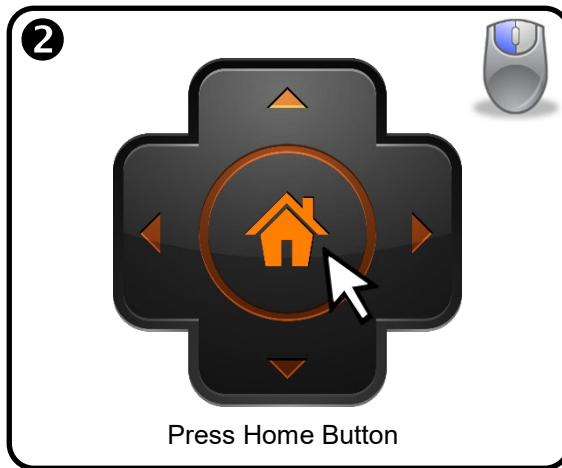
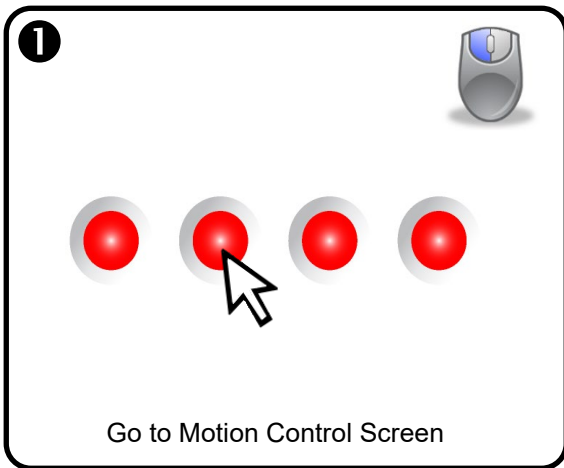

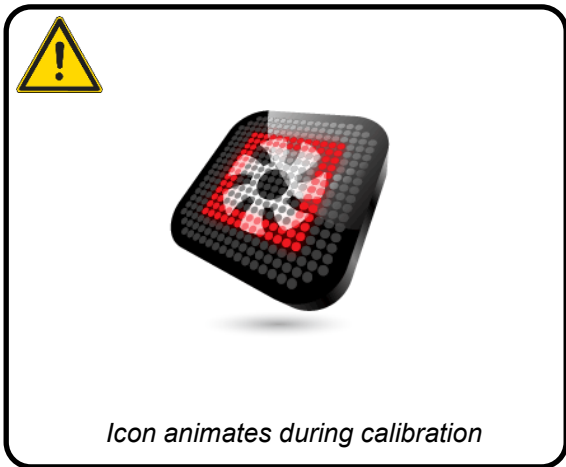
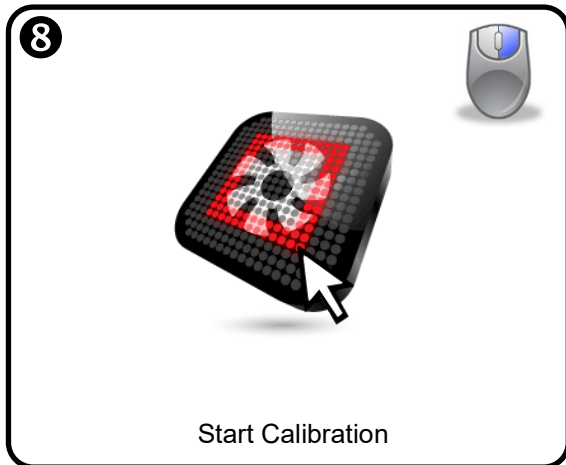
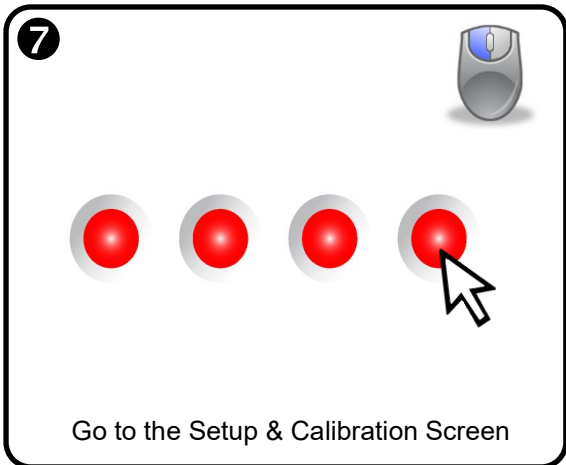
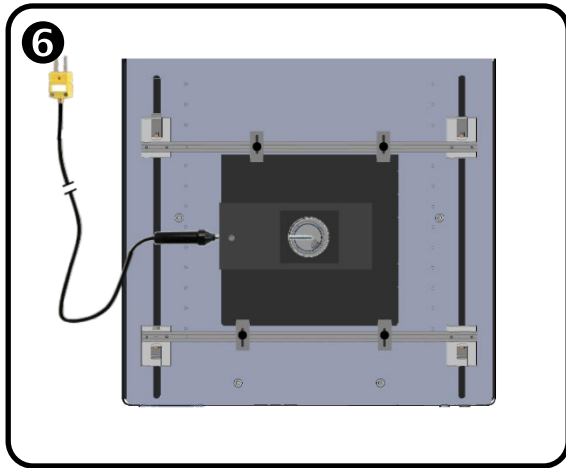
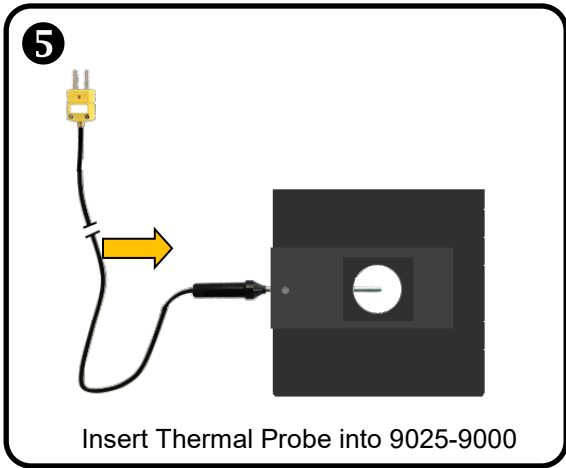



Surround Heater Calibration

- Required:
 - Heater Calibration Kit; SCS-CALKIT

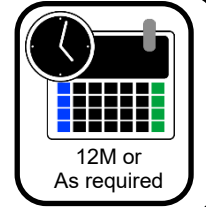

5300-0017

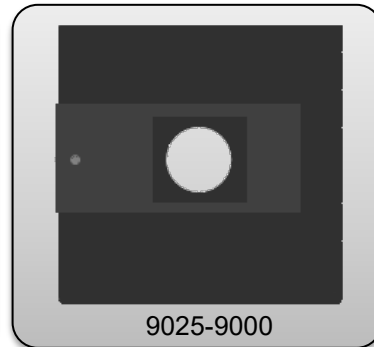
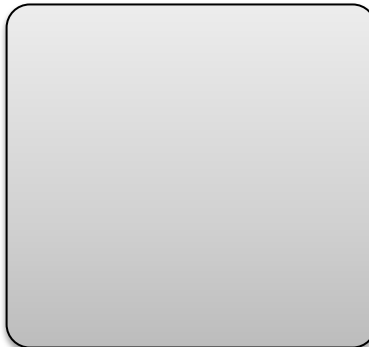

9025-9000

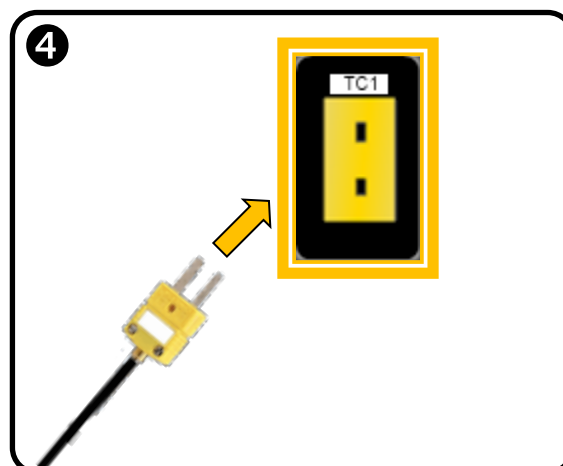
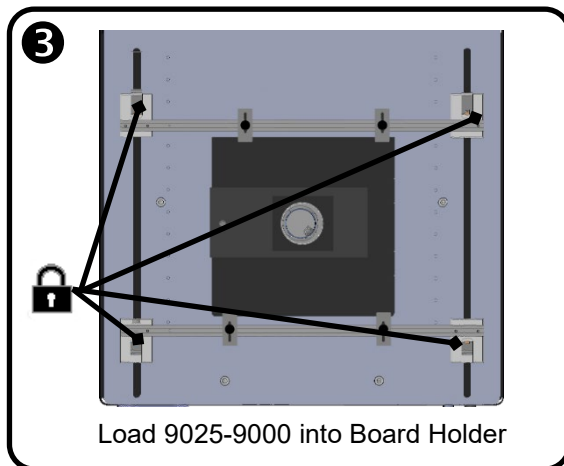
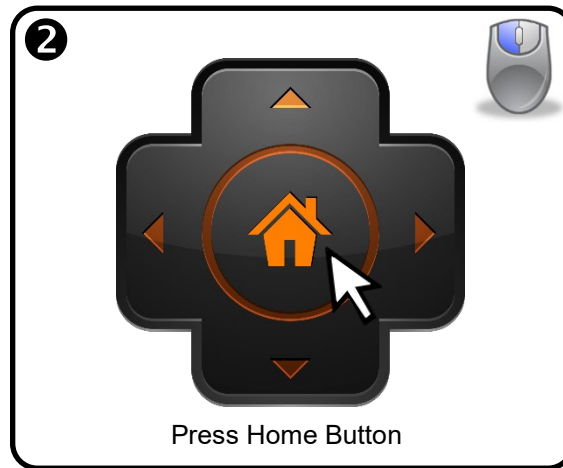
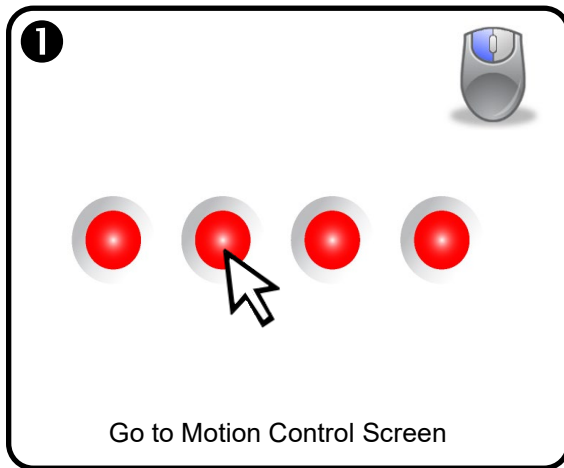

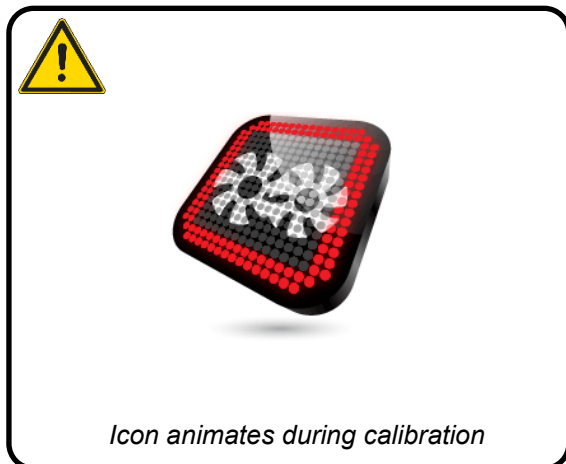
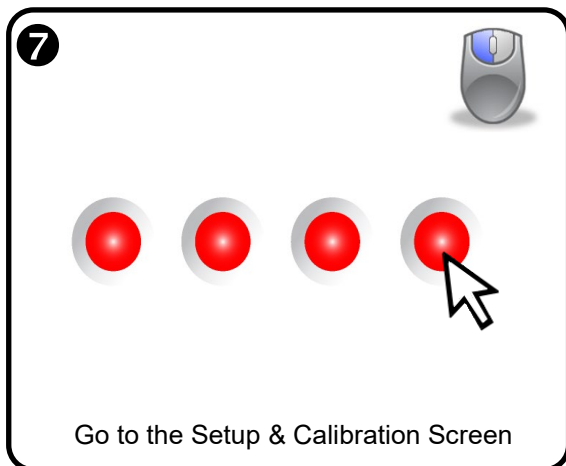
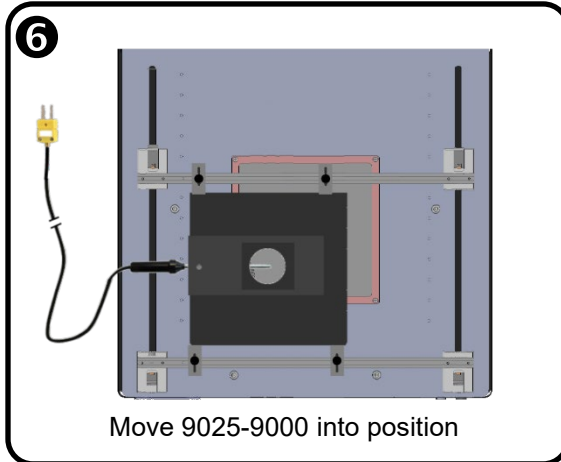
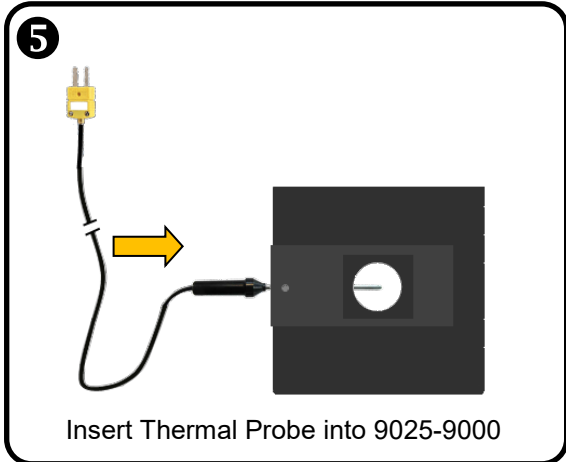



Glue Remover Calibration

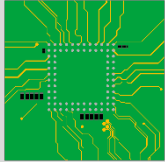

APR-MRS Demo



UBS-SCS

1

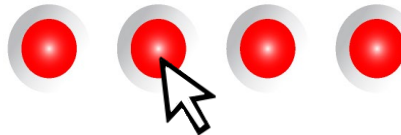

Go to Motion Control Screen

2

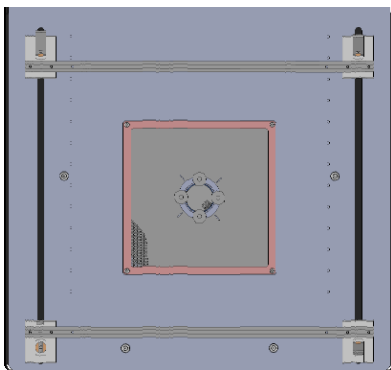

Install under board support

3

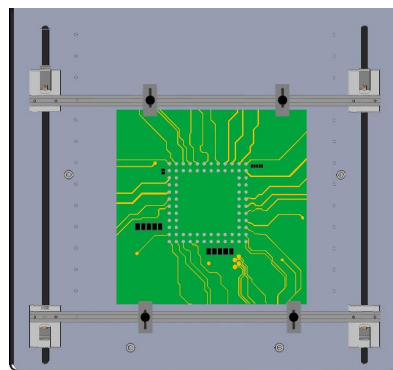

Load PCBA into Board Holder

4



Press Min Z Button

5



Adjust Z-axis until 1.75mm above reference

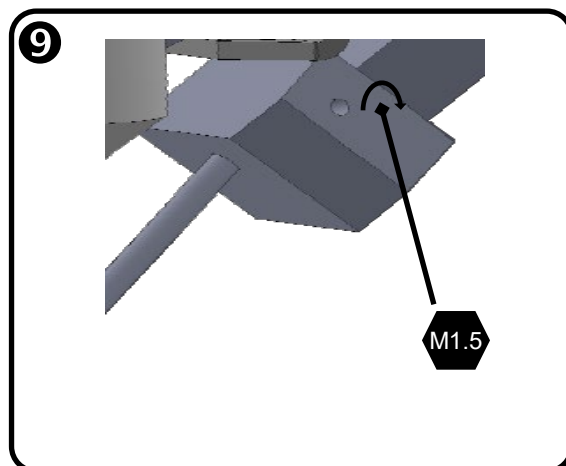
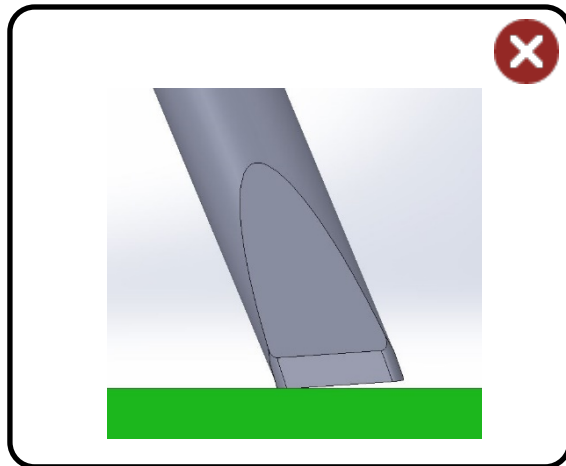
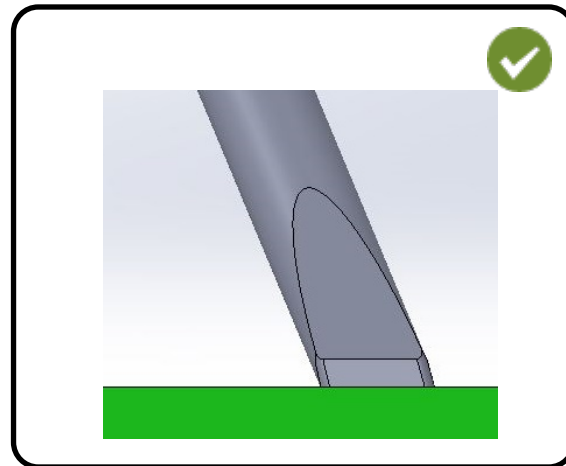
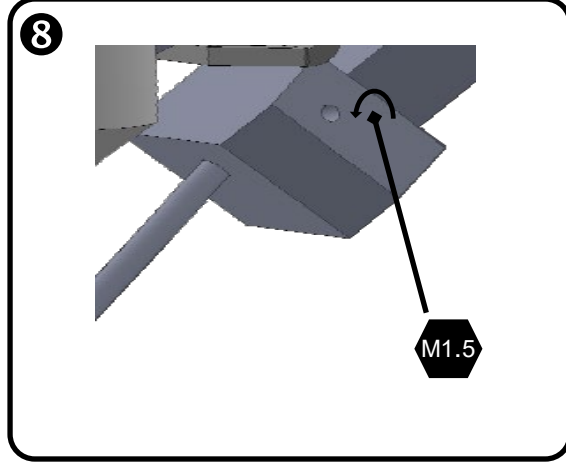
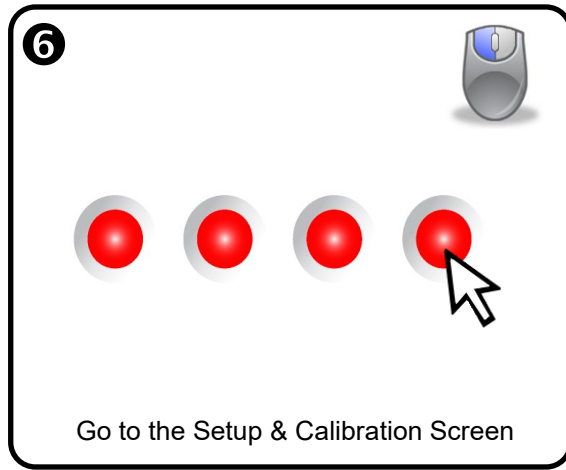
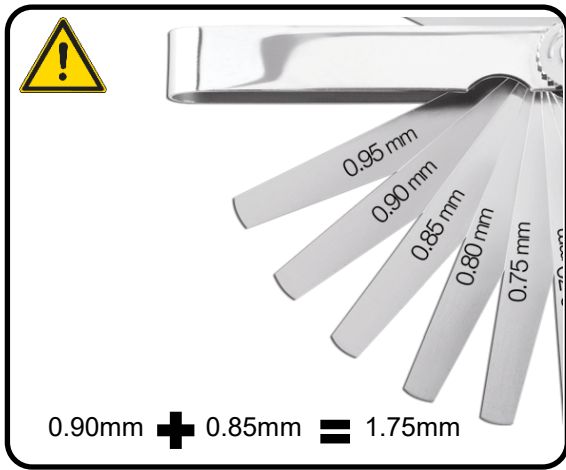

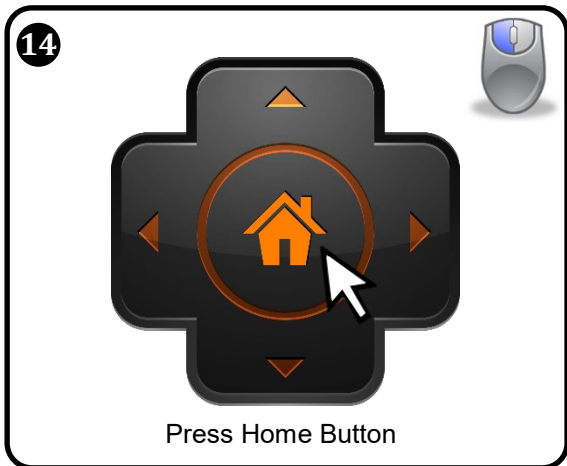
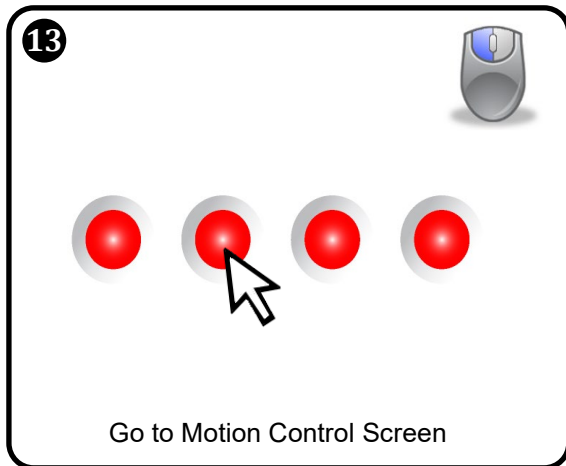
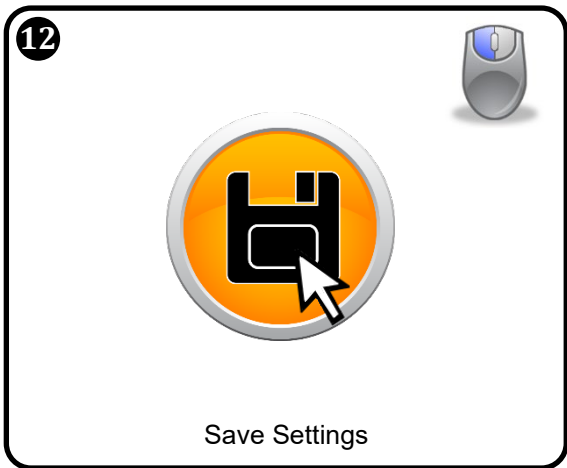
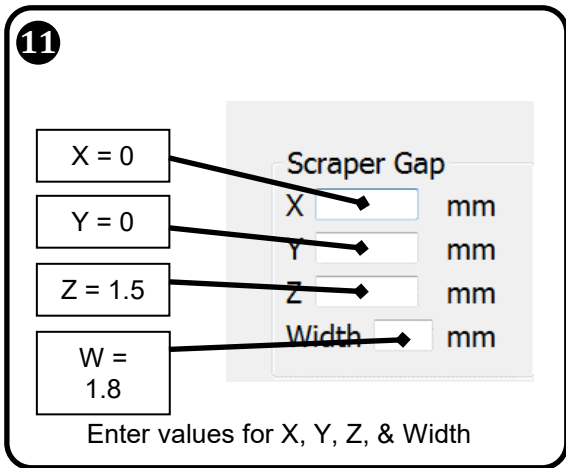
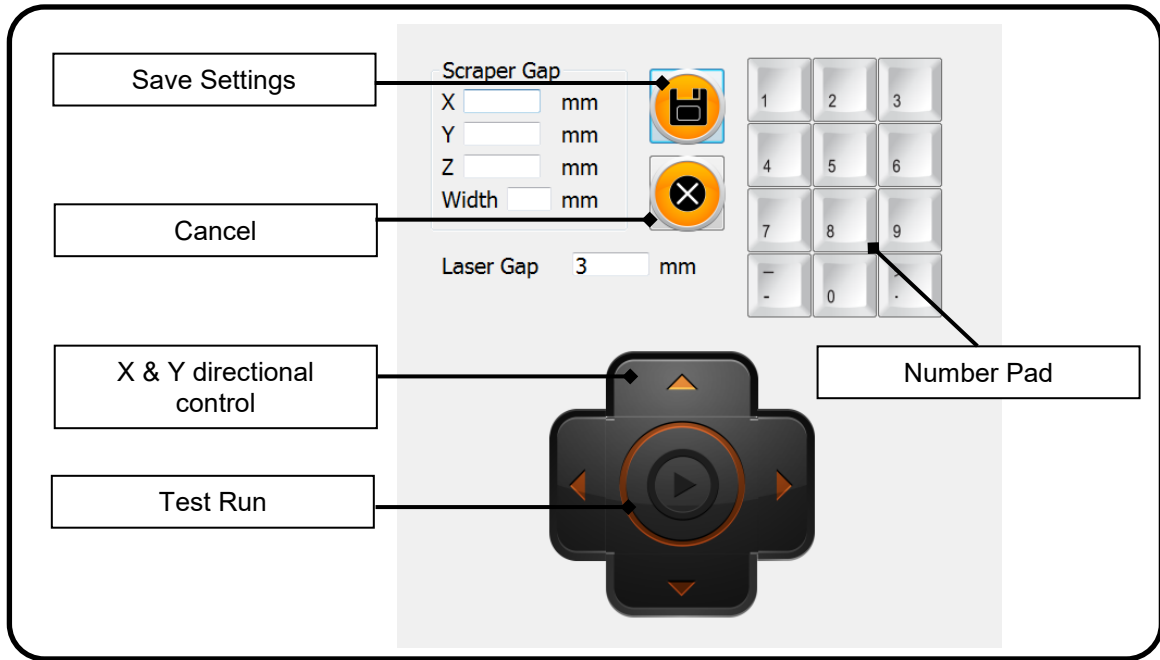

15

1

Set Motion Control Parameters

2 Set Pitch 1.27

16

Activate Laser Crosshair

17

Center pad area over the preheater using crosshair laser

18

Move crosshair laser to Start Location

19

Save Start Location

20

Press Min Z Button

21

Go to the Setup & Calibration Screen

22 



Activate Glue Remover Calibration

23 



 If the unit begins moving and pulsing air (as it would during normal operation,) verify that the glue scraping button is selected, as described in step 15. **The glue remover calibration test will only work if the glue removal function has been activated.**

24 

Reposition the glue scraper as shown in the following pictures.

Record the direction and number of button clicks.

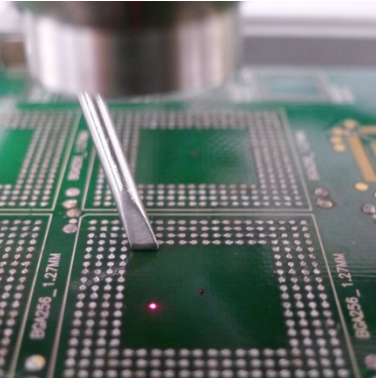
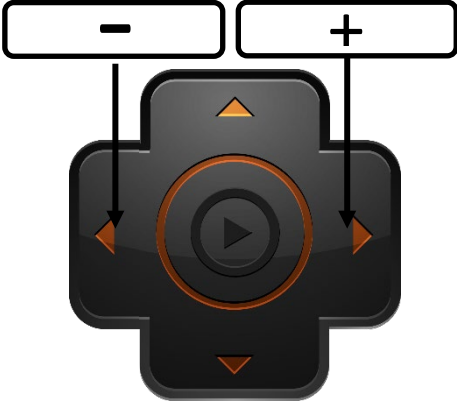

X-axis adjustment



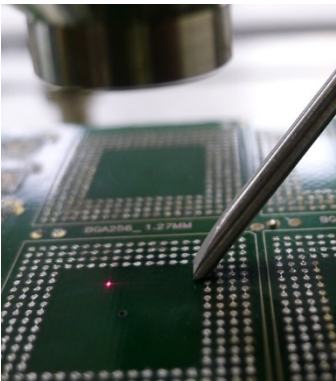
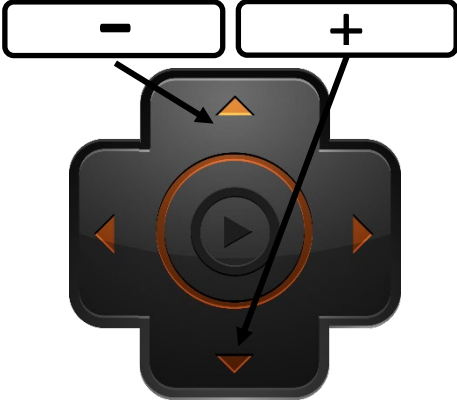

Y-axis adjustment









25

of button clicks  0.25mm  *Direction  X-axis Value

*Direction  = -1  = 1

26

of button clicks  0.25mm  *Direction  Y-axis Value

*Direction  = -1  = 1

27

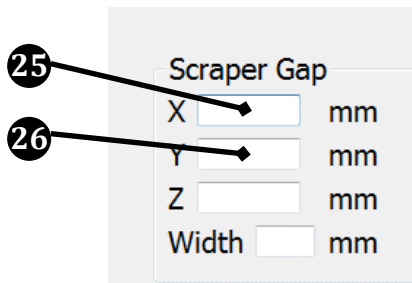

Enter values from **25** & **26**

28



Save Settings

29

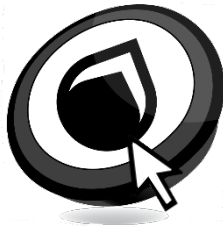

Deactivate Glue Remover

30

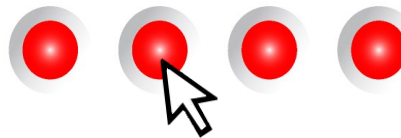

Go to Motion Control

31



Go to Start

32



Press Min Z Button

33

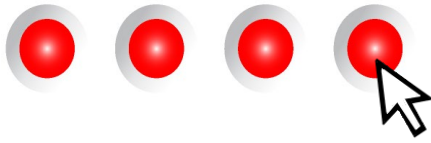

Go to the Setup & Calibration Screen

34

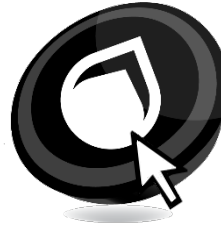

Activate Glue Remover Calibration

35



12 months or as needed

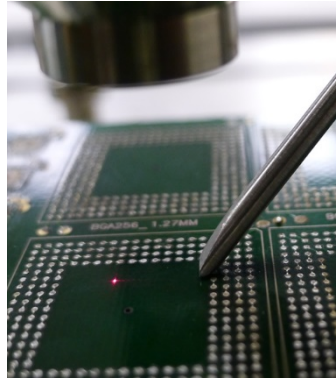
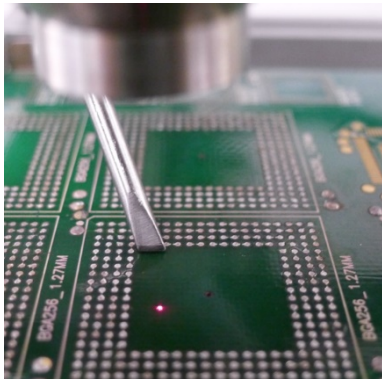



Solder Path Cleaning

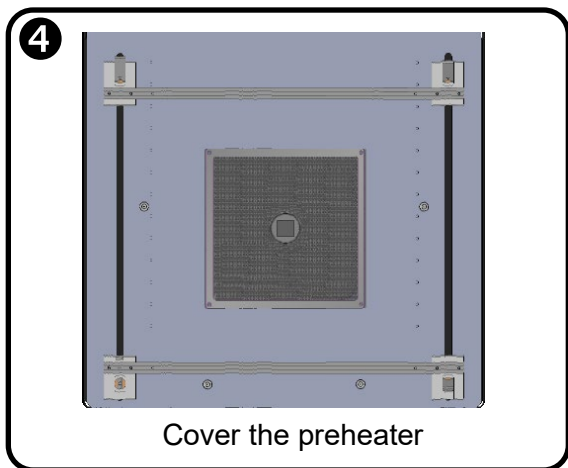
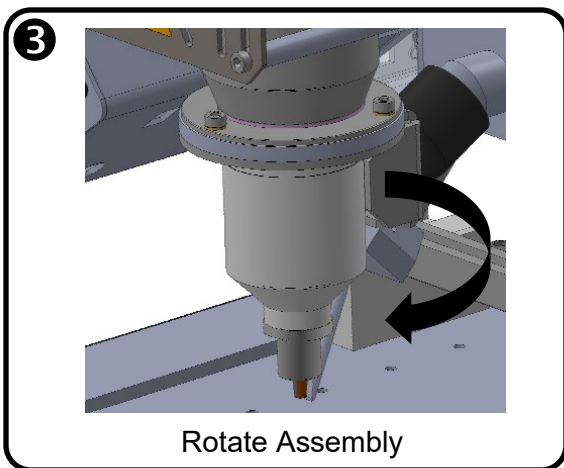
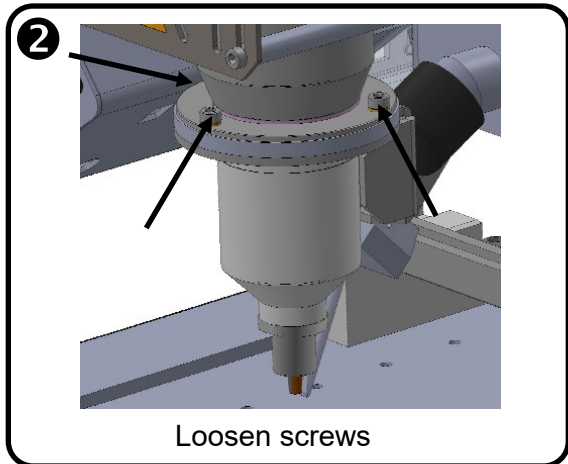
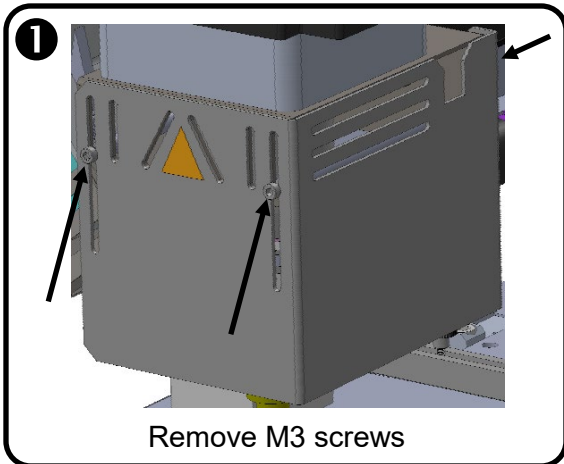
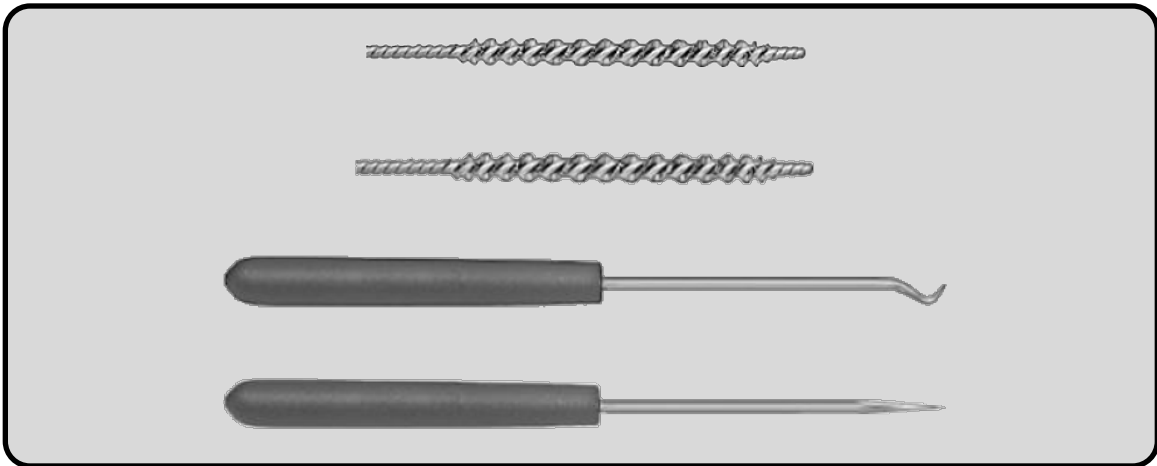

5

Press the Open Profile Icon

6

Select the CleanSCS.rem

7

Press the Open Icon

8

Run the Profile

9

Clean the vacuum tube.
Tube will be hot.

10

Stop the Profile

11

Allow System to Cool

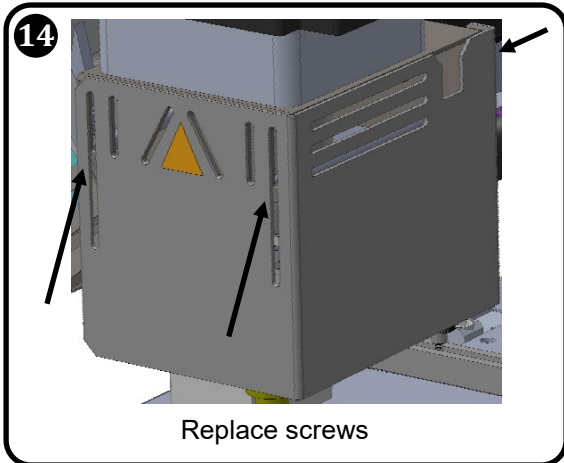
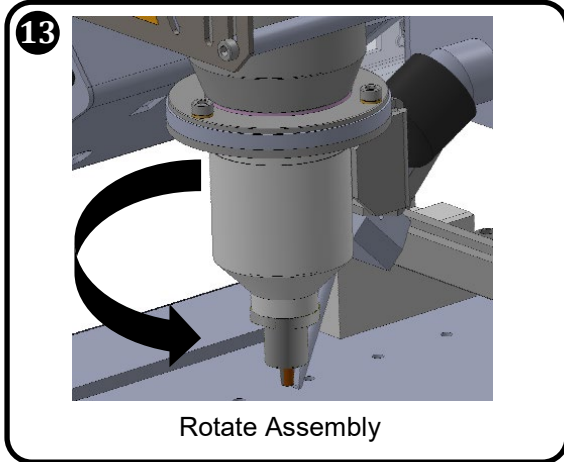
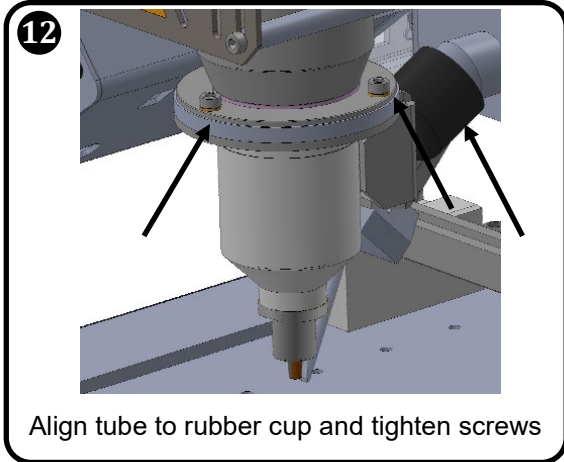



Alternate Software Installation



Download the latest version of the Scarab software from <http://apr-rework.descoindustries.com/Software-Downloads.aspx>

2



Transfer the file to a USB flash drive with a 2GB or greater capacity into the USB connector

3

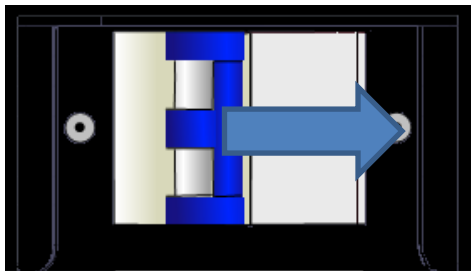

Turn off power to the unit

4



Insert a USB flash drive with a 2GB or greater capacity into the USB connector

5





Factory Restore

1



- Hover the cursor over the factory restore icon

2



- Left click the factory restore icon to restore saved settings.



Save Factory Default

1



- Hover the cursor over the factory restore icon

2



- Right click the factory restore icon to save the settings.

REFLOW NOZZLES, VACUUM NOZZLES, ACCESSORIES, and SPARE PARTS

Vacuum Nozzle (Included*)

SVN-01	Vacuum Nozzle, 1.4mm O/D
SVN-02	Vacuum Nozzle, 2.3mm O/D

Reflow Nozzle (Included*)

SRN-06	Reflow Nozzle, 6.3 mm O/D
SRN-09	Reflow Nozzle, 8.8 mm O/D
SRN-11	Reflow Nozzle, 11.3 mm O/D

Accessories (Included)

AC-RP	Nozzle Removal Pad
FP-19-HDMI	19" Flat Panel Display
FL-SCS-3	PCB Finger Long (Pack 3)
KAP-100	Kapton labels (100 labels)
APR-TC3	Package of K type thermocouples
SCS-LAT	Laser Adjustment Tool
SCS-PMK	Scarab Preventative Maintenance Kit
MFR-FTKIT	Fitting/Air Hose Kit (shop-air connections)

CALIBRATION KIT & SPARE PARTS

SCS-UBS	Under Board Support Scarab Site Cleaning System
SCS-CALKIT	Calibration Kit
SCS-CCK	Collection Chamber Kit
SCS-VR	Venturi Replacement
SCS-VS1	Vacuum Solenoid 3-port
SCS-VS2	Vacuum Solenoid 4-port
SRS-SPK	Surround Preheater Kit (2 heaters)
SRS-PB	Preheater Blower
SRS-PHO	Preheater O-ring
SCS-IOPCB	Scarab I/O PCB
SCS-MPCB	Scarab Main PCB
SRS-SSR	Solid State Relay
SRS-CBSW	Circuit breaker power switch
SCS-HSLM	Scarab Height Sensing Module
SCS-CALM	Scarab Crosshair Alignment Laser Module
SRS-RBC	Reflow Blower Controller
SRS-1224PS	12-24V Power Supply
SRS-5PS	5V Power Supply
SRS-EMI	EMI Filter
SCS-RHK	Reflow Heater Kit
SRS-RB	Reflow Blower
	K type Thermocouple Tester

TECHNICAL SUPPORT: Email Service@APR-Rework.com

LIMITED WARRANTY: APR-Rework.com/Limited-Warranty.aspx