

1-pole, solid state relay for resistive loads



Main features

- Zero cross switching AC solid state relay
- Triac output (100 AAC version with back to back thyristor output)
- Integrated overvoltage protection on output
- DC or AC control voltage
- LED for control presence indication
- Clip-on IP20 protection cover
- Self-lifting terminals

Description

The zero cross switching relay with triac output is an inexpensive solution for resistive loads. The zero switching relay switches ON when the sinusoidal voltage crosses zero and switches OFF when the current crosses zero. The LED indicates the status of the control input. The clip-on cover is securing touch protection to IP20.

Specifications are at a surrounding temperature of 25°C unless otherwise specified.

Applications

Plastic injection machines, extrusion machines, blow moulding machines, thermoformers, dryers, electrical ovens, fryers, shrink tunnels, air handling units, reflow ovens, ambient heating, coffee machines.

Main functions

- 1-pole, zero cross switching
- Rated output voltage up to 528 VAC
- Rated output current up to 100 AAC
- 3-32 VDC or 80-250 VAC control voltage range

 Order code

 RS1A E

Enter the code option instead of . Refer to the Selection guide section for valid part numbers.

Code	Option	Description	Comments
R	-	Solid State Relay (RS)	
S	-		
1	-	1-pole switching	
A	-	Zero Cross switching (ZC)	
<input type="checkbox"/>	40	Rated voltage: 24 - 440 VAC, 600 Vp	
	48	Rated voltage: 24 - 528 VAC, 800 Vp	42 - 528 VAC, 1200 Vp for RS1A48..60/80/100E variants
<input type="checkbox"/>	D	Control voltage: 3 - 32 VDC	4 - 32 VDC for RS1A48..60/80/100E variants
	A	Control voltage: 80 - 250 VAC	
<input type="checkbox"/>	25	Rated current: 25 AAC (215 A ² s)	
	40	Rated current: 40 AAC (560 A ² s)	
	60	Rated current: 60 AAC (1500 A ² s)	
	80	Rated current: 80 AAC (3200 A ² s)	
	100	Rated current: 100 AAC (6000 A ² s)	
E	-	Enhanced	
<input type="checkbox"/>	B	Bulk packaging x 120 pcs	

 Selection guide: RS..E

Rated voltage, Blocking voltage, Switching mode	Control voltage	Maximum rated operational current				
		25 AAC (215 A ² s)	40 AAC (560 A ² s)	60 AAC (1500 A ² s)	80 AAC (3200 A ² s)	100 AAC (6000 A ² s)
400 VAC, 600 Vp, ZC	3 - 32 VDC	RS1A40D25E	RS1A40D40E	RS1A40D60E	RS1A40D80E	RS1A40D100E
	80 - 250 VAC	RS1A40A25E	RS1A40A40E	-	-	-
480 VAC, 800 Vp, ZC	3 - 32 VDC	RS1A48D25E	RS1A48D40E	-	-	-
	80 - 250 VAC	RS1A48A25E	RS1A48A40E	-	-	-
480 VAC, 1200 Vp, ZC	4 - 32 VDC	-	-	RS1A48D60E	RS1A48D80E	RS1A48D100E
	80 - 250 VAC	-	-	RS1A48A60E	RS1A48A80E	RS1A48A100E

Selection guide: RS..EB

Rated voltage, Blocking voltage, Switching mode	Control voltage	Maximum rated operational current				
		25 AAC (215 A ² s)	40 AAC (560 A ² s)	60 AAC (1500 A ² s)	80 AAC (3200 A ² s)	100 AAC (6000 A ² s)
400 VAC, 600 Vp, ZC	3 - 32 VDC	RS1A40D25EB	RS1A40D40EB	RS1A40D60EB	RS1A40D80EB	-

Carlo Gavazzi compatible components

Description	Component code	Notes
FASTON terminals	RM48**/F4*	- Faston tabs (pack of 20) - Tab dimensions according to DIN 46342 part 1 - Pure tin-plated brass
Fork terminals	RM635FK/P	- Terminal adaptors for 35mm ² cable - Type RM635FK (P version with touch protection) - Pack size: 10 pieces
Thermal pads	KK071CUT	- Graphite thermal pad with adhesive on one side - Dimensions: 35 x 43 x 0.25 mm - Packing quantity: 50 pieces
Touch safety cover	RMIP20	- IP20 protection degree - Pack size: 20 pieces
Heatsinks	RHS	Heatsinks and fans
Mounting screws kit	SRWKITM5X10MM	- M5 x 10 mm with captivated washer - Pack size: 20 pieces

Carlo Gavazzi further reading

Information	Where to find it	Notes
Datasheet	https://gavazziautomation.com/images/PIM/DATASHEET/ENG/SSR_Accessories.pdf	Solid state relay Accessories (including Heatsinks)
	https://www.gavazziautomation.com/nsc/HQ/EN/heat_sink_selector_tool	Online Heatsink selector tool

Structure

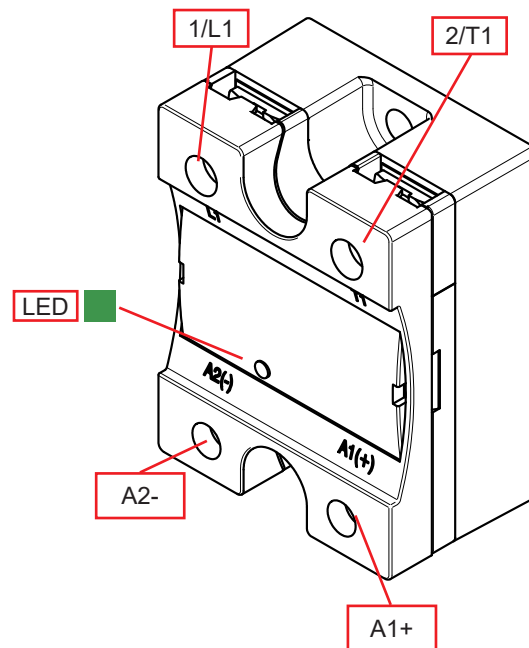

Element	Component	Function
1/L1	Power connection	Mains connection
2/T1	Power connection	Load connection
A1+, A2-	Control connection	Terminals for control voltage
LED	ON indicator	Indicates presence of control voltage

Features

General data

Material	Noryl GFN 1, black	
Mounting	Panel mount	
Touch Protection	IP20	
Baseplate	Aluminium	
Isolation	Input to output Input to case Output to case RS1A..25, 40E Output to case RS1A..60, 80, 100E	≥ 4000 VACrms ≥ 4000 VACrms ≥ 2500 VACrms ≥ 4000 VACrms
Weight	RS1A..25, 40, 100E RS1A..60, 80E	approx. 85 g approx. 79 g

Dimensions

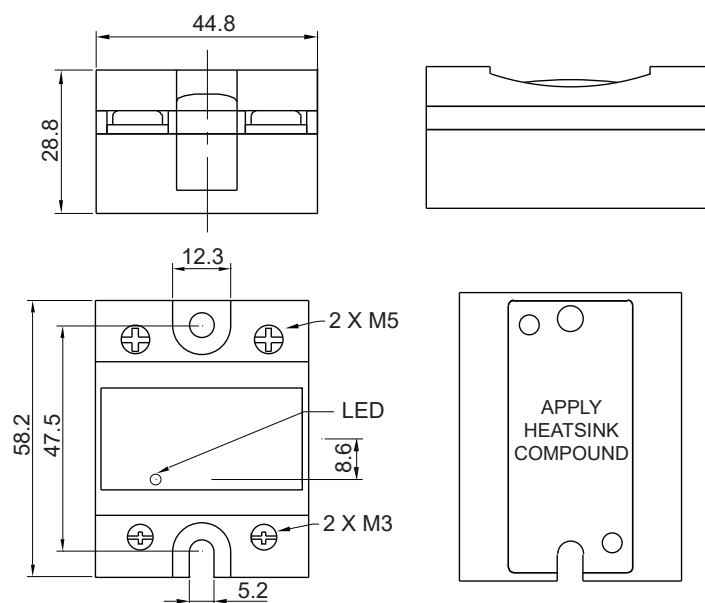

Dimensions in mm.
Tolerances ± 0.5 mm.

Performance

Output specifications

	RS1A..25E	RS1A..40E	RS1A..60E	RS1A..80E	RS1A..100E
Max. operational current ¹ : AC-51	25 AAC	40 AAC	60 AAC	80 AAC	100 AAC
Operational frequency range	45 to 65 Hz				
Output protection	Integrated varistor				
Leakage current @ rated voltage	< 3 mAAC				
Minimum operational current	250 mAAC	400 mAAC	250 mAAC	400 mAAC	500 mAAC
Non-repetitive surge current (I_{TSM}), t=20 ms	175 Ap	280 Ap	550 Ap	800 Ap	1096 Ap
I ² t for fusing (t=10 ms), minimum	215 A ² s	560 A ² s	1500 A ² s	3200 A ² s	6000 A ² s
Power factor	> 0.95 at rated voltage				
Critical dV/dt (@T _J init = 40°C)	≥ 1000 V/μs				

1. Refer to Heatsink selection section

Output voltage specifications

	RS1A40..E	RS1A48..E
Operational voltage range 25 A, 40 A 60 A, 80 A, 100 A	24 to 440 VAC	24 to 528 VAC 42 to 528 VAC
Blocking voltage 25 A, 40 A 60 A, 80 A, 100 A	600 Vp	800 Vp 1200 Vp

Inputs

	RS1A40D..E	RS1A48D..E	RS1A..A..E
Control voltage range 25 A, 40 A 60 A, 80 A, 100 A	3 - 32 VDC	3 - 32 VDC 4 - 32 VDC	80 - 250 VAC
Pick-up voltage 25 A, 40 A 60 A, 80 A, 100 A	3 VDC	3 VDC 4 VDC	70 VAC
Drop-out voltage	1.2 VDC		15 VAC
Maximum reverse voltage	32 VDC		-
Maximum response time pick-up	1/2 cycle		1 cycle
Response time drop-out	≤ 1/2 cycle		2.5 cycles
Input current @ max input voltage	≤ 15 mA		≤ 12.5 mA

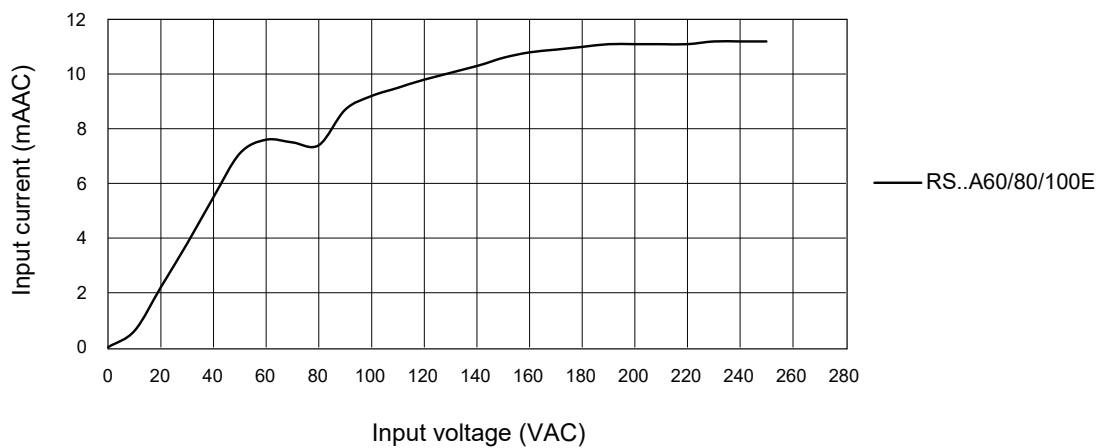
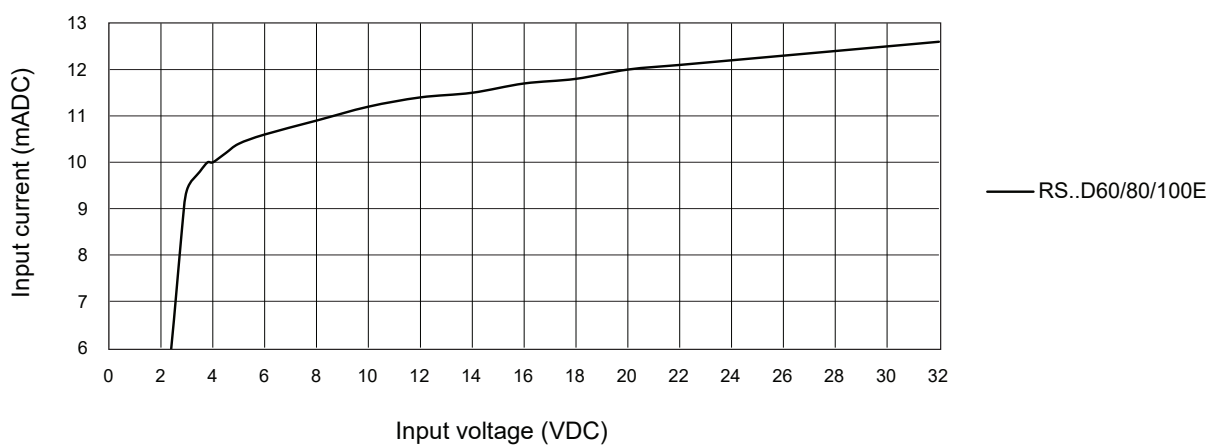
Input current vs. input voltage**AC input****DC input**

Output power dissipation

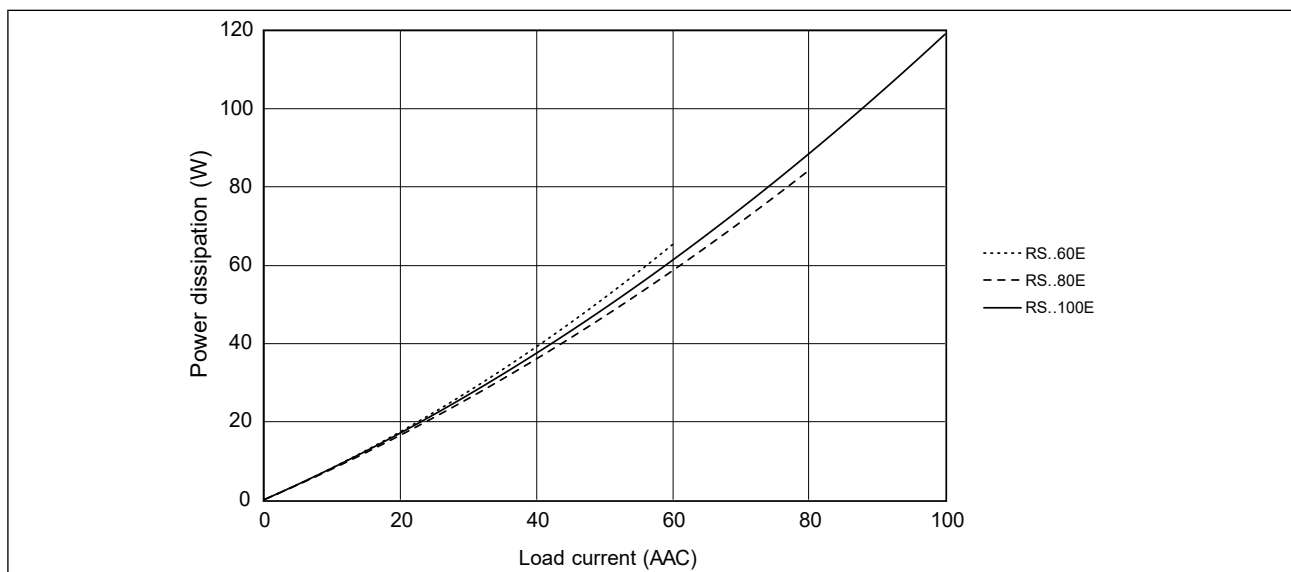
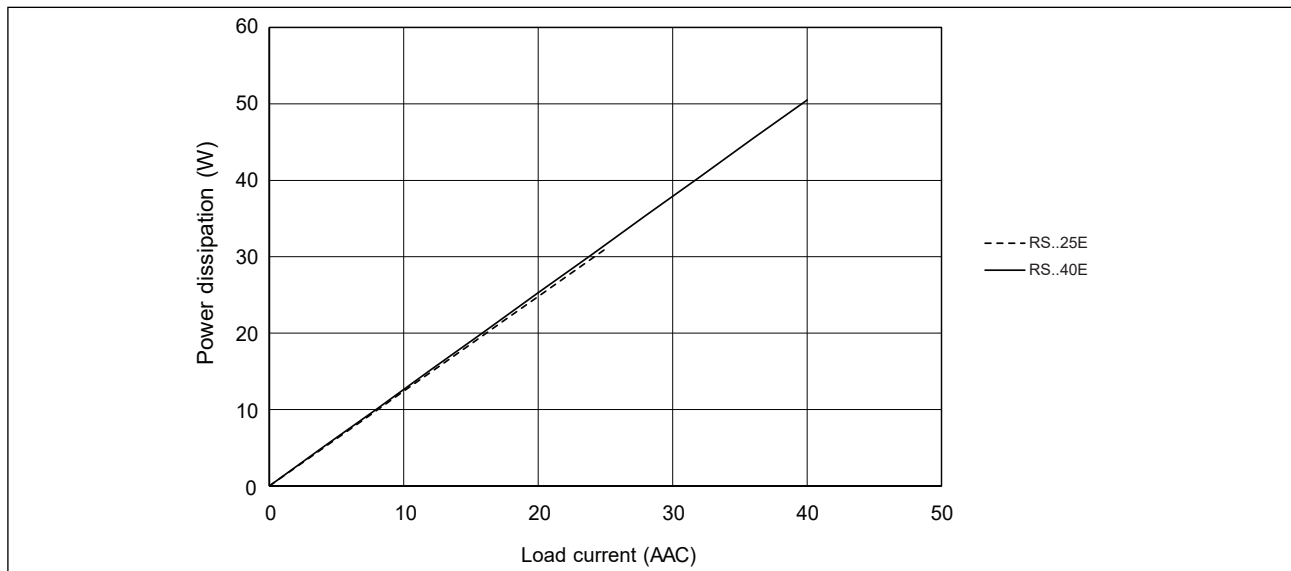

Thermal data

	RS1A..25E	RS1A..40E	RS1A..60E	RS1A..80E	RS1A..100E
Max. junction temperature	125°C				
Junction to case thermal resistance, R_{thjc}	<2.31°C/W	<1.68°C/W	<0.90°C/W	<0.63°C/W	<0.35°C/W
Case to heatsink thermal resistance, R_{thcs}^2	< 0.054°C/W	< 0.054°C/W	<0.20°C/W	<0.15°C/W	<0.10°C/W

2. Thermal resistance case to heatsink values are applicable upon application of a fine layer of silicon based thermal paste HTS02S from Electrolube between SSR and heatsink.

Heatsink selection

Thermal resistance [°C/W] of RS1A..25E

Load current [A]	Surrounding ambient temperature [°C]					
	20	30	40	50	60	70
25.0	1.02	0.70	0.37	0.05	-	-
22.5	1.39	1.04	0.68	0.32	-	-
20.0	1.86	1.46	1.06	0.65	0.25	-
17.5	2.47	2.00	1.54	1.08	0.62	0.16
15.0	3.27	2.73	2.19	1.66	1.12	0.58
12.5	4.39	3.75	3.10	2.46	1.18	1.17
10.0	6.08	5.28	4.47	3.66	2.86	2.05
7.5	8.89	7.82	6.74	5.67	4.59	3.50
5.0	13.7	12.0	10.4	8.82	7.20	5.59
2.5	nh	nh	nh	17.7	14.5	11.2

Thermal resistance [°C/W] of RS1A..40E

Load current [A]	Surrounding ambient temperature [°C]					
	20	30	40	50	60	70
40.0	0.36	0.16	-	-	-	-
36.0	0.60	0.38	0.16	-	-	-
32.0	0.89	0.65	0.40	0.15	-	-
28.0	1.27	0.99	0.71	0.43	0.14	-
24.0	1.78	1.45	1.12	0.79	0.46	-
20.0	2.50	2.10	1.70	1.31	0.91	0.28
16.0	3.56	3.07	2.57	2.08	1.58	0.80
12.0	5.34	4.68	4.02	3.36	2.71	1.66
8.0	8.36	7.37	6.38	5.39	4.40	3.39
4.0	16.8	14.8	12.8	10.8	8.85	6.87

Thermal resistance [°C/W] of RS1A..60E

Load current [A]	Surrounding ambient temperature [°C]						
	20	30	40	50	60	70	80
60.0	0.71	0.51	0.32	0.13	-	-	-
54.0	1.01	0.78	0.55	0.33	0.12	-	-
48.0	1.41	1.13	0.85	0.59	0.34	0.10	-
42.0	1.97	1.61	1.27	0.94	0.63	0.33	0.05
36.0	2.75	2.31	1.86	1.44	1.04	0.66	0.31
30.0	3.65	3.04	2.48	1.96	1.47	1.02	0.59
24.0	5.17	4.26	3.45	2.70	2.03	1.41	0.83
18.0	8.35	6.71	5.31	4.10	3.04	2.10	1.26
12.0	18.9	13.9	10.3	7.58	5.41	3.64	2.17
6.0	nh	nh	nh	nh	17.3	9.99	5.41

Thermal resistance [°C/W] of RS1A..80E

Load current [A]	Surrounding ambient temperature [°C]						
	20	30	40	50	60	70	80
80.0	0.61	0.46	0.32	0.18	0.04	-	-
72.0	0.85	0.67	0.49	0.33	0.16	0.01	-
64.0	1.15	0.93	0.72	0.52	0.33	0.14	-
56.0	1.57	1.29	1.03	0.79	0.55	0.32	0.11
48.0	2.08	1.75	1.44	1.14	0.86	0.57	0.30
40.0	2.74	2.29	1.88	1.49	1.12	0.78	0.45
32.0	3.86	3.19	2.59	2.04	1.54	1.07	0.63
24.0	6.14	4.97	3.95	3.07	2.29	1.59	0.95
16.0	13.3	10.0	7.53	5.59	4.03	2.73	1.63
8.0	nh	nh	nh	nh	12.3	7.31	4.03

Thermal resistance [°C/W] of RS1A..100E

Load current [A]	Surrounding ambient temperature [°C]						
	20	30	40	50	60	70	80
100.0	0.51	0.41	0.32	0.22	0.13	0.03	-
90.0	0.67	0.56	0.44	0.33	0.22	0.11	0.01
80.0	0.88	0.74	0.60	0.47	0.34	0.21	0.08
70.0	1.12	0.95	0.79	0.63	0.47	0.32	0.18
60.0	1.42	1.20	0.99	0.79	0.60	0.42	0.24
50.0	1.86	1.57	1.30	1.04	0.79	0.55	0.33
40.0	2.60	2.18	1.80	1.43	1.09	0.77	0.46
30.0	4.04	3.34	2.71	2.14	1.62	1.14	0.70
20.0	8.03	6.35	4.97	3.81	2.82	1.96	1.20
10.0	nh	nh	18.8	12.0	7.89	5.02	2.90

"nh" means no heatsink necessary. The SSR should still be tightened to a surface to ensure optimal thermal dissipation.

Compatibility and conformance

Approvals	
Standards compliance	LVD: EN 60947-4-3 EMCD: EN 60947-4-3 EE: EN 60947-4-3 EMC: EN 60947-4-3 cURus: UL508 Recognized (E80573), NRNT2, NRNT8 CSA: C22.2 No. 14 (204075)

* applicable only to RS..25E and RS..40E

Electromagnetic compatibility (EMC) - Immunity	
Electrostatic discharge (ESD)	EN/IEC 61000-4-2 8 kV air discharge, 4 kV contact (PC2)
Radiated radio frequency	EN/IEC 61000-4-3 10 V/m, from 80 MHz to 1 GHz (PC1) 10 V/m, from 1.4 to 2 GHz (PC1) 3 V/m, from 2 to 2.7 GHz (PC1)
Electrical fast transient (burst)	EN/IEC 61000-4-4 Output: 2 kV, 5 kHz (PC2) Input: 1 kV, 5 kHz (PC2)
Conducted radio frequency	EN/IEC 61000-4-6 10 V/m, from 0.15 to 80 MHz (PC1)
Electrical surge	EN/IEC 61000-4-5 Output, line to line: 1 kV (PC2) Output, line to earth: 1 kV (PC2) Output, line to earth: 2 kV (PC2)* Input, line to line: 1 kV (PC2) Input, line to earth: 2 kV (PC2)
Voltage dips	EN/IEC 61000-4-11 0% for 0.5, 1 cycle (PC2) 40% for 10 cycles (PC2) 70% for 25 cycles (PC2) 80% for 250 cycles (PC2)
Voltage interruptions	EN/IEC 61000-4-11 0% for 5000 ms (PC2)

*with external suppression for RS..25E, RS..40E

Electromagnetic compatibility (EMC) - Emissions	
Radio interference field emission (radiated)	EN/IEC 55011 Class A: from 30 to 1000 MHz
Radio interference voltage emissions (conducted)	EN/IEC 55011 Class A: from 0.15 to 30 MHz. External filter may be required.

Note:

- Control input lines must be installed together to maintain products' susceptibility to Radio Frequency interference.
- The control terminals A1, A2 (RS1A..A.) shall be supplied by a secondary circuit where power is limited by a transformer, rectifier, voltage divider, or similar device that derives power from a primary circuit, and where the short-circuit limit between conductors of the secondary circuit or between conductors and ground is 1500 VA or less. The short-circuit volt ampere limit is the product of the open circuit voltage and the short circuit ampere.
- Performance Criteria 1 (PC1): No degradation of performance or loss of function is allowed when the product is operated as intended.
- Performance Criteria 2 (PC2): During the test, degradation of performance or partial loss of function is allowed. However when the test is complete the product should return operating as intended by itself.
- Performance Criteria 3 (PC3): Temporary loss of function is allowed, provided the function can be restored by manual operation of the controls.

Environmental specifications

Operating temperature	-20°C to +70°C (-4°F to +158°F) max. +60°C (+140°F) for RS..A60/80/100E
Storage temperature	-40°C to +100°C (-40°F to +212°F)
Relative humidity	< 95% non-condensing
Pollution degree	2
Installation altitude	0-1000 m. Above 1000 m derate linearly by 1% of FLC per 100 m up to a maximum of 2000 m
EU RoHS compliant	Yes
China RoHS	

The declaration in this section is prepared in compliance with People's Republic of China Electronic Industry Standard SJ/T11364-2014: Marking for the Restricted Use of Hazardous Substances in Electronic and Electrical Products.

Part Name	Toxic or Hazardous Substances and Elements					
	Lead (Pb)	Mercury (Hg)	Cadmium (Cd)	Hexavalent Chromium (Cr(VI))	Polybrominated biphenyls (PBB)	Polybrominated diphenyl ethers (PBDE)
Power Unit Assembly	x	○	○	○	○	○

O: Indicates that said hazardous substance contained in homogeneous materials for this part are below the limit requirement of GB/T 26572.

X: Indicates that said hazardous substance contained in one of the homogeneous materials used for this part is above the limit requirement of GB/T 26572.

这份申明根据中华人民共和国电子工业标准
SJ/T11364-2014：标注在电子电气产品中限定使用的有害物质

零件名称	有毒或有害物质与元素					
	铅 (Pb)	汞 (Hg)	镉 (Cd)	六价铬 (Cr(VI))	多溴联苯 (PBB)	多溴联苯醚 (PBDE)
功率单元	x	○	○	○	○	○

O:此零件所有材料中含有的该有害物低于GB/T 26572的限定。

X: 此零件某种材料中含有的该有害物高于GB/T 26572的限定。

Short circuit protection, co-ordination type 2

Part No.	Prospective short circuit current [kArms]	Ferraz Shawmut (Mersen)		Max. voltage [VAC]
		Max fuse size [A]	Part number	
RS1A..25E	-	-		-
RS1A..40E				
RS1A..60E	5	40	5014006.40 VC22-40A700VAC	528
RS1A..80E		63	5014006.63 VC22-63A700VAC	528
RS1A..100E		80	5014006.80 VC22-80A700VAC	528

Connection diagram

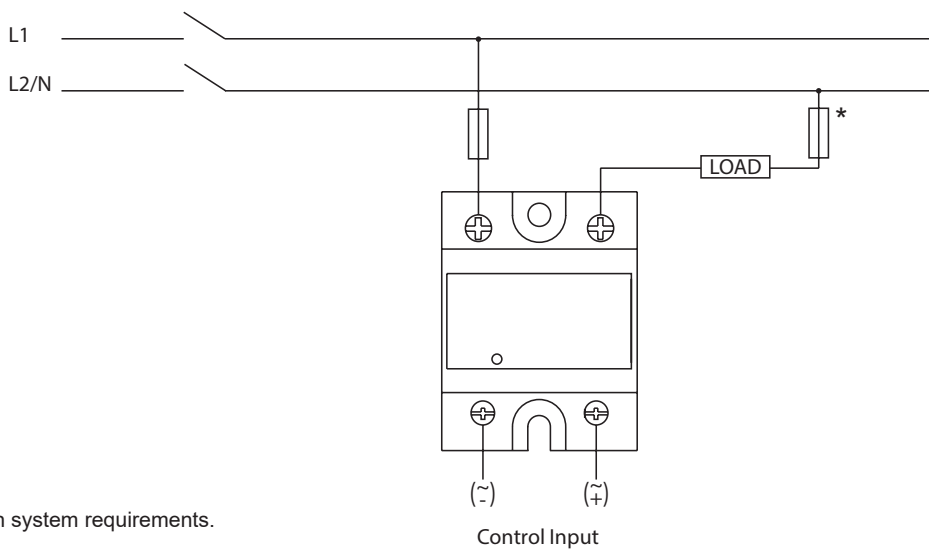

* Depends on system requirements.

Functional diagram

RS1A..25, 40, 60, 80E

DC control

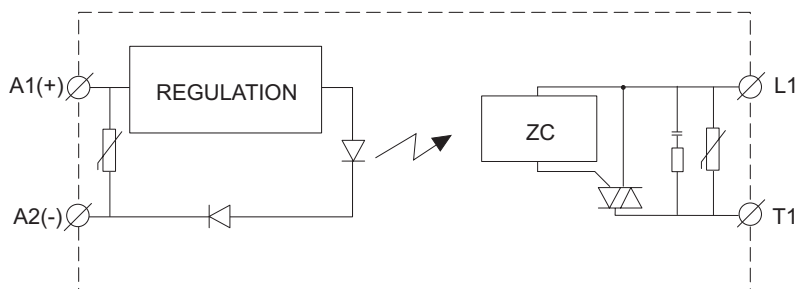

AC control

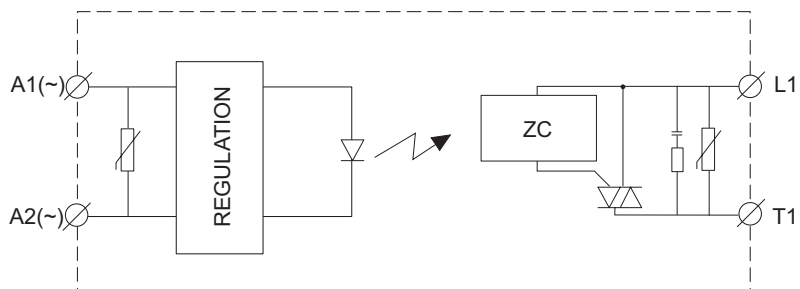

RS1A..100E

DC control

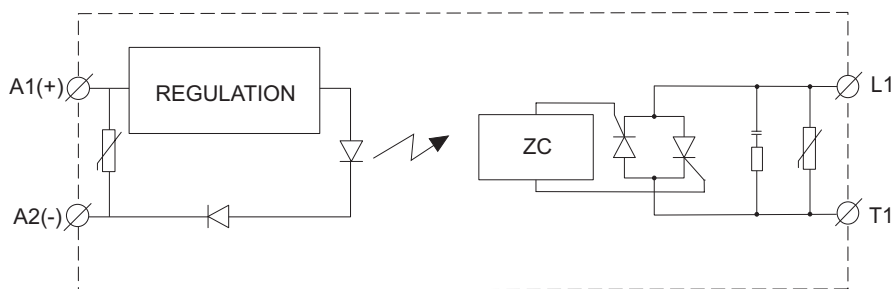

AC control

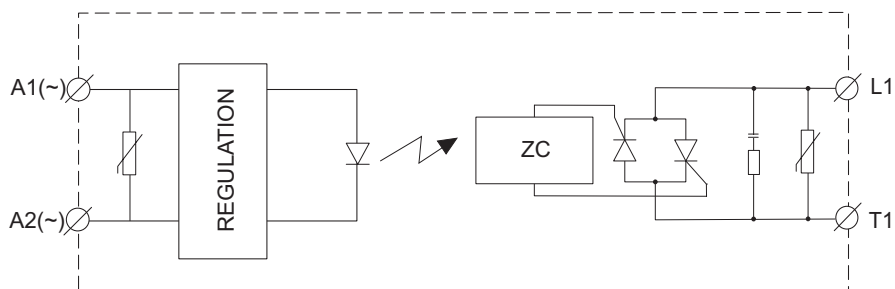

Connection Specifications

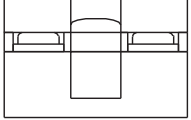
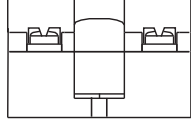
	1/L2, 2/T1		A1+, A2-	
				
Mounting screws (SSR to heatsink)	M5, not provided with SSR (refer to SRWKITM5X10MM in the Compatible components section)			
Mounting torque (SSR to heatsink)	1.5 - 2.0 Nm (13.3 - 17.7 lb-in)			
Connection type	M5 screw with captivated washer		M3 screw with captivated washer	
Stripping length	12 mm		8 mm	
Rigid (solid & stranded) UR/cUR rated data	1 x 2.5 – 6.0 mm ² 1 x 14 – 10 AWG	2x 2.5 – 6.0 mm ² 2x 14 – 10 AWG	1x 0.5 – 2.5 mm ² 1x 18 – 12 AWG	2x 0.5 - 2.5 mm ² 2x 18 - 12 AWG
Flexible with end sleeve	1 x 1.0 – 4.0 mm ² 1 x 18 – 12 AWG	2x 1.0 – 2.5 mm ² 2x 2.5 – 4.0 mm ² 2x 18 – 14 AWG 2x 14 – 12 AWG	1x 0.5 – 2.5 mm ² 1x 18 – 12 AWG	2x 0.5 - 2.5 mm ² 2x 18 - 12 AWG
Flexible without end sleeve	2x 1.0 – 6.0 mm ² 2x 18 – 10 AWG	2x 1.0 – 2.5 mm ² 2x 2.5 – 6.0 mm ² 2x 18 – 14 AWG 2x 14 – 10 AWG	1x 1.0 – 6.0mm ² 1x 18 –10 AWG	
Torque specifications	Posidrive bit 2 2.4 Nm (21.2 lb-in)		Posidrive bit 1 0.5 Nm (4.4 lb-in)	
Aperture for termination lug (fork or ring)	12 mm		7.5 mm	



COPYRIGHT ©2023
 Content subject to change.
 Download the PDF: <https://gavazziautomation.com>