

Main Product Characteristics

$V_{(BR)DSS}$	60V
$R_{DS(ON)}$	12m Ω
I_D	50A

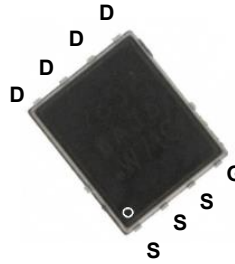

PPAK5x6

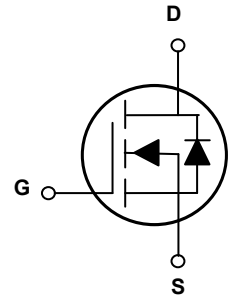

Schematic Diagram

Features and Benefits

- Advanced MOSFET process technology
- Ideal for high efficiency switched mode power supplies
- Low on-resistance with low gate charge
- Fast switching and reverse body recovery



Description

The SSFP6904 utilizes the latest techniques to achieve high cell density and low on-resistance. These features make this device extremely efficient and reliable for use in high efficiency switch mode power supply and a wide variety of other applications.

Absolute Maximum Ratings ($T_C=25^\circ\text{C}$ unless otherwise specified)

Parameter	Symbol	Rating	Unit
Drain-Source Voltage	V_{DS}	60	V
Gate-Source Voltage	V_{GS}	± 20	V
Drain Current – Continuous ($T_C=25^\circ\text{C}$)	I_D	50	A
Drain Current – Continuous ($T_C=100^\circ\text{C}$)		31	A
Drain Current – Pulsed ¹	I_{DM}	200	A
Single Pulse Avalanche Energy ²	E_{AS}	61	mJ
Single Pulse Avalanche Current ²	I_{AS}	35	A
Power Dissipation ($T_C=25^\circ\text{C}$)	P_D	96	W
Power Dissipation – Derate above 25°C		0.77	W/ $^\circ\text{C}$
Storage Temperature Range	T_{STG}	-55 to +150	$^\circ\text{C}$
Operating Junction Temperature Range	T_J	-55 to +150	$^\circ\text{C}$

Thermal Characteristics

Parameter	Symbol	Typ.	Max.	Unit
Thermal Resistance Junction to Ambient	$R_{\theta JA}$	---	62	$^\circ\text{C}/\text{W}$
Thermal Resistance Junction to Case	$R_{\theta JC}$	---	1.3	$^\circ\text{C}/\text{W}$

Electrical Characteristics (T_J=25°C unless otherwise specified)

Parameter	Symbol	Conditions	Min.	Typ.	Max.	Unit
Off Characteristics						
Drain-Source Breakdown Voltage	BV _{DSS}	V _{GS} =0V, I _D =250uA	60	---	---	V
BV _{DSS} Temperature Coefficient	ΔBV _{DSS} /ΔT _J	Reference to 25°C, I _D =1mA	---	0.03	---	V/°C
Drain-Source Leakage Current	I _{DSS}	V _{DS} =60V, V _{GS} =0V, T _J =25°C	---	---	1	uA
		V _{DS} =48V, V _{GS} =0V, T _J =125°C	---	---	10	uA
Gate-Source Leakage Current	I _{GSS}	V _{GS} =±20V, V _{DS} =0V	---	---	±100	nA
On Characteristics						
Static Drain-Source On-Resistance	R _{DS(ON)}	V _{GS} =10V, I _D =10A	---	10	12	mΩ
		V _{GS} =4.5V, I _D =8A	---	12	15	mΩ
Gate Threshold Voltage	V _{GS(th)}	V _{GS} =V _{DS} , I _D =250uA	1.2	1.6	2.5	V
V _{GS(th)} Temperature Coefficient	ΔV _{GS(th)}		---	-4	---	mV/°C
Forward Transconductance	g _{fs}	V _{DS} =10V, I _D =6A	---	11.7	---	S
Dynamic and Switching Characteristics						
Total Gate Charge ^{3,4}	Q _g	V _{DS} =30V, V _{GS} =10V, I _D =10A	---	39.2	59	nC
Gate-Source Charge ^{3,4}	Q _{gs}		---	5.9	9	
Gate-Drain Charge ^{3,4}	Q _{gd}		---	8.8	14	
Turn-On Delay Time ^{3,4}	T _{d(on)}	V _{DD} =15V, V _{GS} =10V, R _G =6Ω I _D =1A	---	9.6	18	nS
Rise Time ^{3,4}	T _r		---	28.2	54	
Turn-Off Delay Time ^{3,4}	T _{d(off)}		---	45.3	86	
Fall Time ^{3,4}	T _f		---	10.9	21	
Input Capacitance	C _{iss}	V _{DS} =25V, V _{GS} =0V, F=1MHz	---	2100	3050	pF
Output Capacitance	C _{oss}		---	165	240	
Reverse Transfer Capacitance	C _{rss}		---	80	120	
Gate Resistance	R _g	V _{GS} =0V, V _{DS} =0V, F=1MHz	---	1.6	3.2	Ω
Drain-Source Diode Characteristics and Maximum Ratings						
Parameter	Symbol	Conditions	Min.	Typ.	Max.	Unit
Continuous Source Current	I _S	V _G =V _D =0V, Force Current	---	---	55	A
Pulsed Source Current	I _{SM}		---	---	200	A
Diode Forward Voltage	V _{SD}	V _{GS} =0V, I _S =1A, T _J =25°C	---	---	1	V

Note:

1. Repetitive Rating: Pulsed width limited by maximum junction temperature.
2. V_{DD}=25V, V_{GS}=10V, L=0.1mH, I_{AS}=35A, R_G=25Ω, Starting T_J=25°C.
3. The data tested by pulsed, pulse width ≤ 300uS, duty cycle ≤ 2%.
4. Essentially independent of operating temperature.

Typical Electrical and Thermal Characteristic Curves

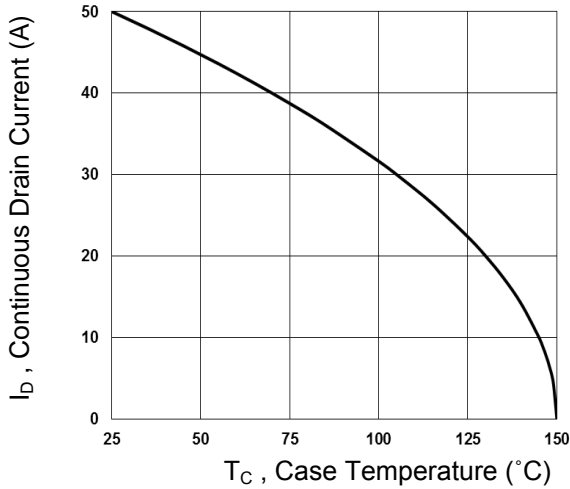

Fig.1 Continuous Drain Current vs. T_C

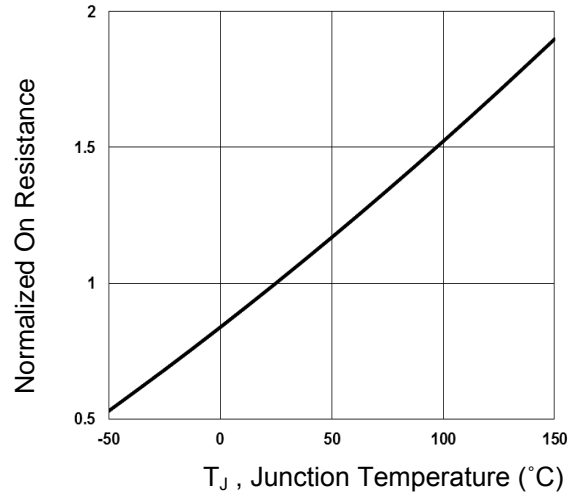

Fig.2 Normalized $R_{DS(ON)}$ vs. T_J

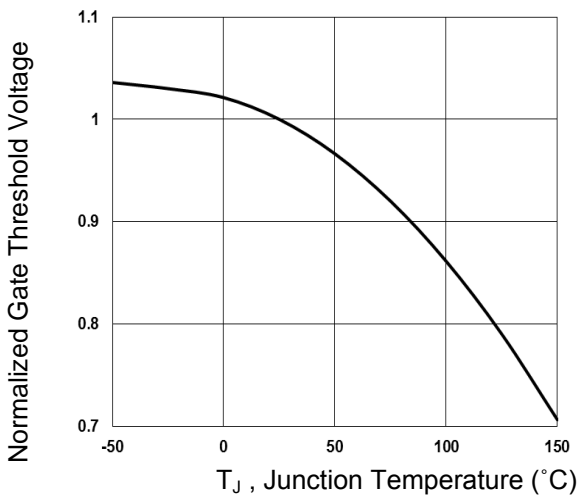

Fig.3 Normalized V_{th} vs. T_J

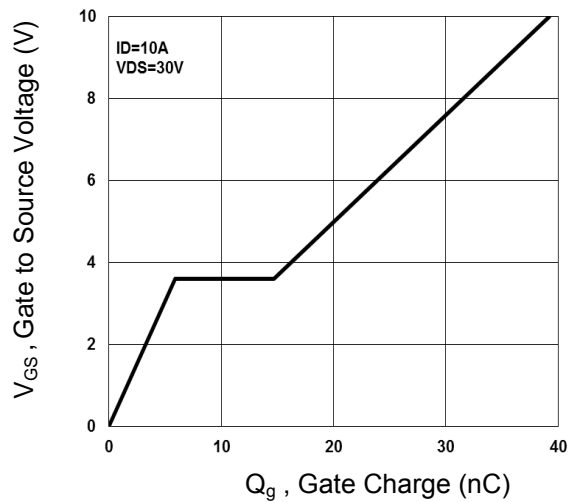

Fig.4 Gate Charge Waveform

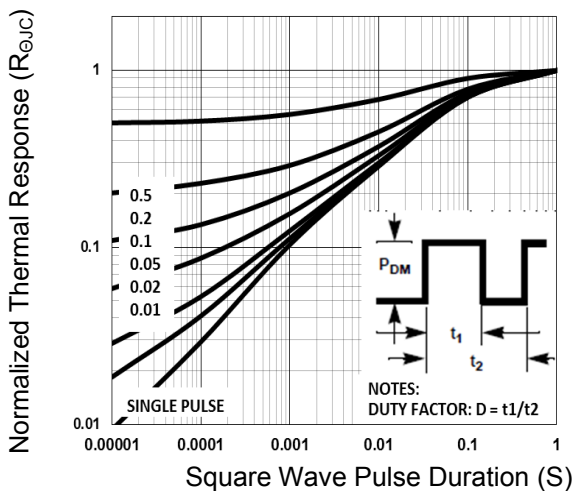

Fig.5 Normalized Transient Impedance

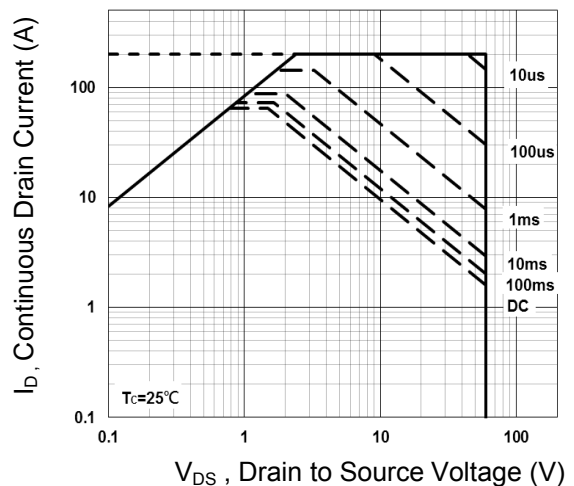

Fig.6 Maximum Safe Operation Area

Typical Electrical and Thermal Characteristic Curves

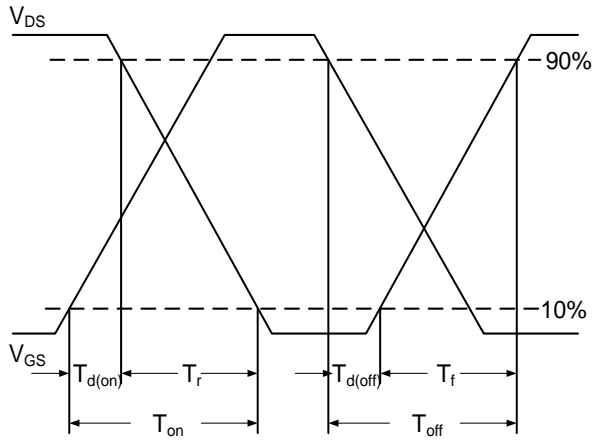

Fig.7 Switching Time Waveform

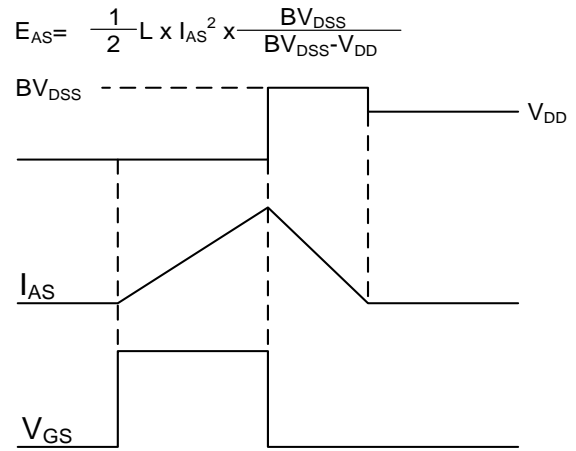
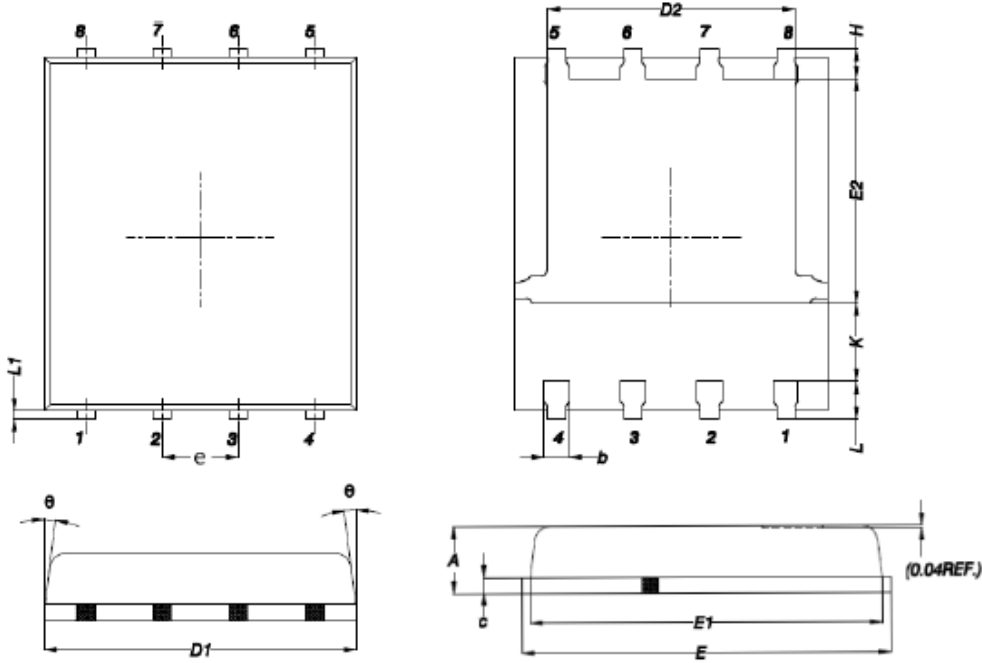

Fig. 8 E_{AS} Waveform

Package Outline Dimensions

PPAK5x6



Symbol	Dimensions In Millimeters		Dimensions In Inches	
	MAX	MIN	MAX	MIN
A	1.200	0.850	0.047	0.031
b	0.510	0.300	0.020	0.012
C	0.300	0.200	0.012	0.008
D1	5.400	4.800	0.212	0.189
D2	4.310	3.610	0.170	0.142
E	6.300	5.850	0.248	0.230
E1	5.960	5.450	0.235	0.215
E2	3.920	3.300	0.154	0.130
e	1.27BSC		0.05BSC	
H	0.650	0.380	0.026	0.015
K	-	1.100	-	0.043
L	0.710	0.380	0.028	0.015
L1	0.250	0.050	0.009	0.002
θ	12°	0°	12°	0°