

Main Product Characteristics

$V_{(BR)DSS}$	60V
$R_{DS(ON)}$	75mΩ
I_D	2.9A

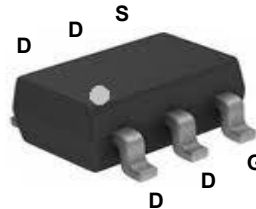

SOT-23-6L

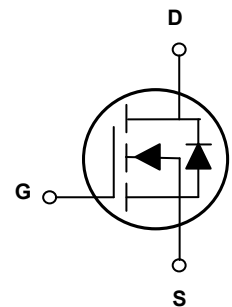

Schematic Diagram

Features and Benefits

- Advanced MOSFET process technology
- Ideal for high efficiency switched mode power supplies
- Low on-resistance with low gate charge
- Fast switching and reverse body recovery



Description

The SSF6912 utilizes the latest techniques to achieve high cell density and low on-resistance. These features make this device extremely efficient and reliable for use in high efficiency switch mode power supply and a wide variety of other applications.

Absolute Maximum Ratings ($T_C=25^{\circ}\text{C}$ unless otherwise specified)

Parameter	Symbol	Rating	Unit
Drain-Source Voltage	V_{DS}	60	V
Gate-Source Voltage	V_{GS}	±20	V
Drain Current – Continuous ($T_A=25^{\circ}\text{C}$)	I_D	2.9	A
Drain Current – Continuous ($T_A=70^{\circ}\text{C}$)		2.3	A
Drain Current – Pulsed ¹	I_{DM}	11.6	A
Power Dissipation ($T_A=25^{\circ}\text{C}$)	P_D	1	W
Power Dissipation – Derate above 25°C		0.008	W/°C
Storage Temperature Range	T_{STG}	-50 to +150	°C
Operating Junction Temperature Range	T_J	-50 to +150	°C

Thermal Characteristics

Parameter	Symbol	Typ.	Max.	Unit
Thermal Resistance Junction to Ambient	$R_{\theta JA}$	---	125	°C/W

Electrical Characteristics ($T_J=25^{\circ}\text{C}$ unless otherwise specified)

Parameter	Symbol	Conditions	Min.	Typ.	Max.	Unit
Off Characteristics						
Drain-Source Breakdown Voltage	BV_{DSS}	$V_{GS}=0V, I_D=250\mu A$	60	---	---	V
BV_{DSS} Temperature Coefficient	$\Delta BV_{DSS}/\Delta T_J$	Reference to 25°C , $I_D=1\text{mA}$	---	0.05	---	$V/^{\circ}\text{C}$
Drain-Source Leakage Current	I_{DSS}	$V_{DS}=60V, V_{GS}=0V, T_J=25^{\circ}\text{C}$	---	---	1	μA
		$V_{DS}=48V, V_{GS}=0V, T_J=125^{\circ}\text{C}$	---	---	10	μA
Gate-Source Leakage Current	I_{GSS}	$V_{GS}=\pm 20V, V_{DS}=0V$	---	---	± 100	nA
On Characteristics						
Static Drain-Source On-Resistance	$R_{DS(ON)}$	$V_{GS}=10V, I_D=2A$	---	60	75	m Ω
		$V_{GS}=4.5V, I_D=1.5A$	---	70	90	m Ω
Gate Threshold Voltage	$V_{GS(th)}$	$V_{GS}=V_{DS}, I_D=250\mu A$	1.2	1.8	2.5	V
$V_{GS(th)}$ Temperature Coefficient	$\Delta V_{GS(th)}$		---	-5	---	mV/ $^{\circ}\text{C}$
Forward Transconductance	g_{fs}	$V_{DS}=10V, I_D=1A$	---	7	---	S
Dynamic and Switching Characteristics						
Total Gate Charge ^{2, 3}	Q_g	$V_{DS}=48V, V_{GS}=10V, I_D=2A$	---	9.3	14	nC
Gate-Source Charge ^{2, 3}	Q_{gs}		---	2.1	4	
Gate-Drain Charge ^{2, 3}	Q_{gd}		---	1.8	4	
Turn-On Delay Time ^{2, 3}	$T_{d(on)}$	$V_{DD}=30V, V_{GS}=10V, R_G=3.3\Omega, I_D=1A$	---	2.9	6	nS
Rise Time ^{2, 3}	T_r		---	9.5	18	
Turn-Off Delay Time ^{2, 3}	$T_{d(off)}$		---	18.4	35	
Fall Time ^{2, 3}	T_f		---	5.3	10	
Input Capacitance	C_{iss}	$V_{DS}=15V, V_{GS}=0V, F=1\text{MHz}$	---	500	725	pF
Output Capacitance	C_{oss}		---	45	65	
Reverse Transfer Capacitance	C_{rss}		---	16	30	
Gate Resistance	R_g	$V_{GS}=0V, V_{DS}=0V, F=1\text{MHz}$	---	2	4	Ω
Drain-Source Diode Characteristics and Maximum Ratings						
Continuous Source Current	I_S	$V_G=V_D=0V$, Force Current	---	---	2.9	A
Pulsed Source Current	I_{SM}		---	---	5.8	A
Diode Forward Voltage	V_{SD}	$V_{GS}=0V, I_S=1A, T_J=25^{\circ}\text{C}$	---	---	1	V
Reverse Recovery Time ²	t_{rr}	$V_{GS}=30V, I_S=1A, di/dt=100A/\mu S, T_J=25^{\circ}\text{C}$	---	23.2	---	nS
Reverse Recovery Charge ²	Q_{rr}		---	14.3	---	nC

Note:

1. Repetitive Rating: Pulsed width limited by maximum junction temperature.
2. The data tested by pulsed, pulse width $\leq 300\mu S$, duty cycle $\leq 2\%$.
3. Essentially independent of operating temperature.

Typical Electrical and Thermal Characteristic Curves

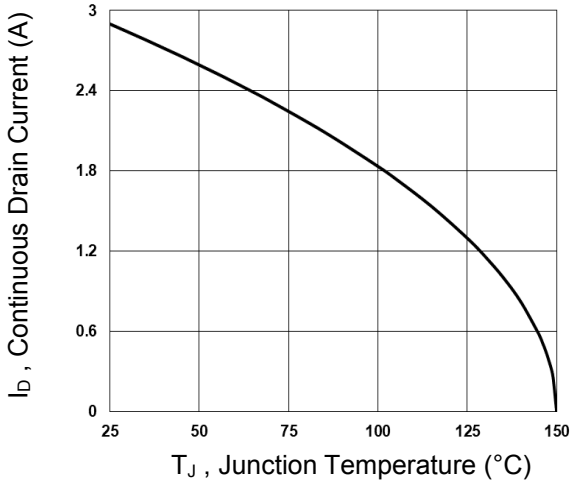

Fig.1 Continuous Drain Current vs. T_J

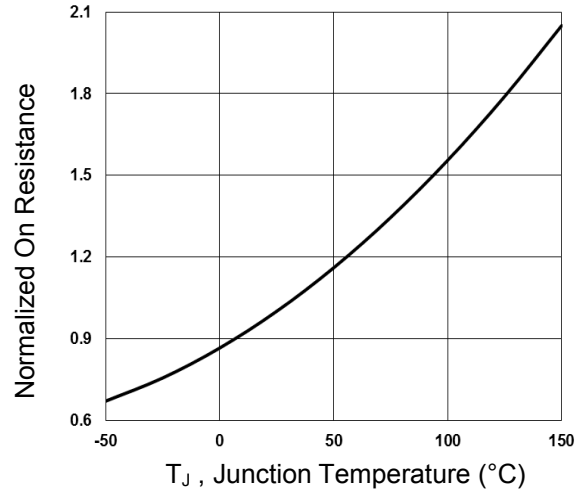

Fig.2 Normalized $R_{DS(ON)}$ vs. T_J

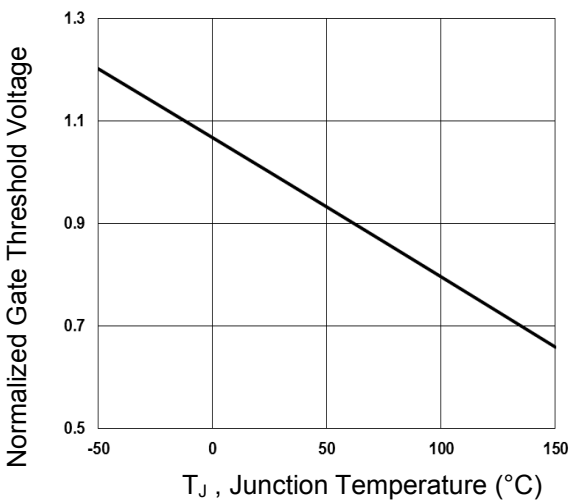

Fig.3 Normalized V_{th} vs. T_J

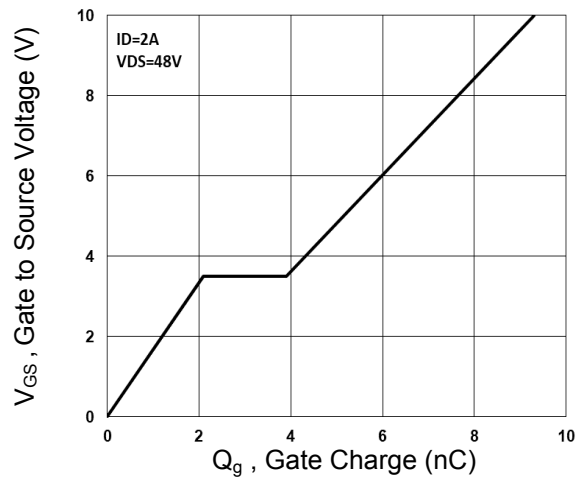

Fig.4 Gate Charge Waveform

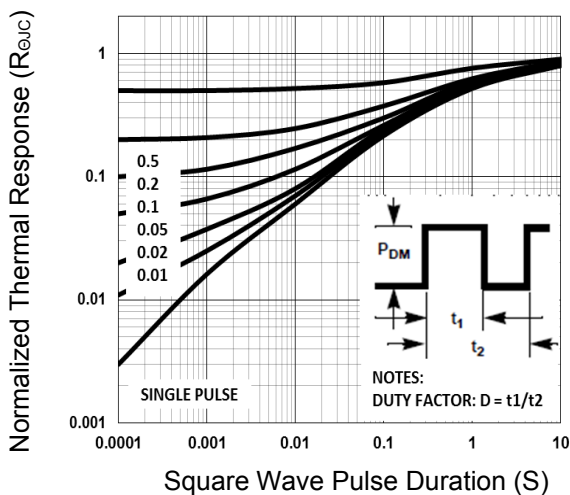

Fig.5 Normalized Transient Response

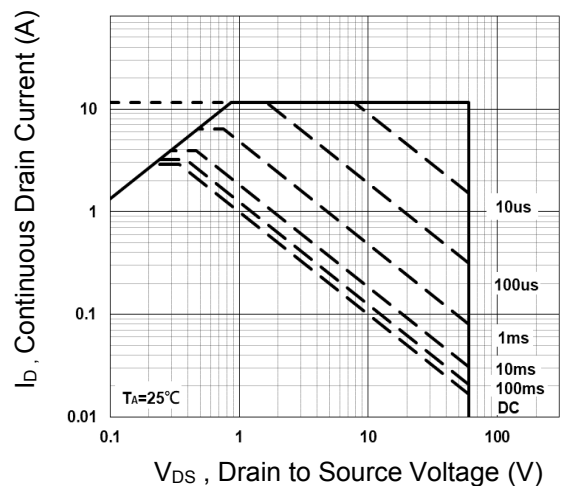

Fig.6 Maximum Safe Operation Area

Typical Electrical and Thermal Characteristic Curves

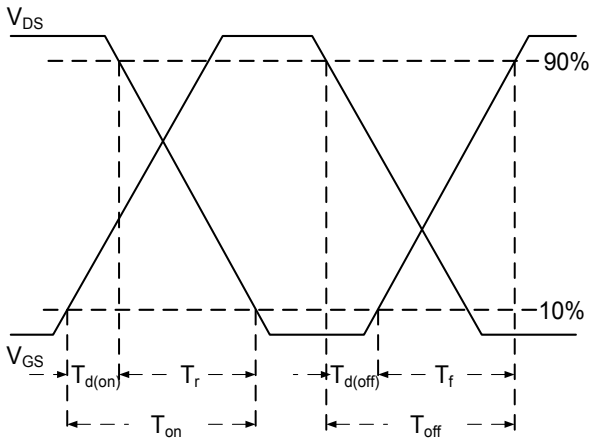

Fig.7 Switching Time Waveform

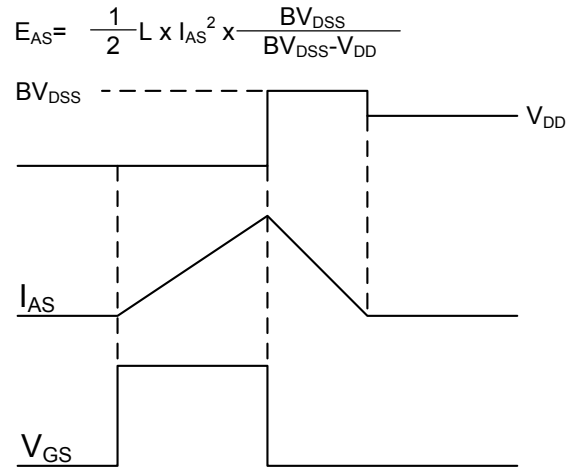
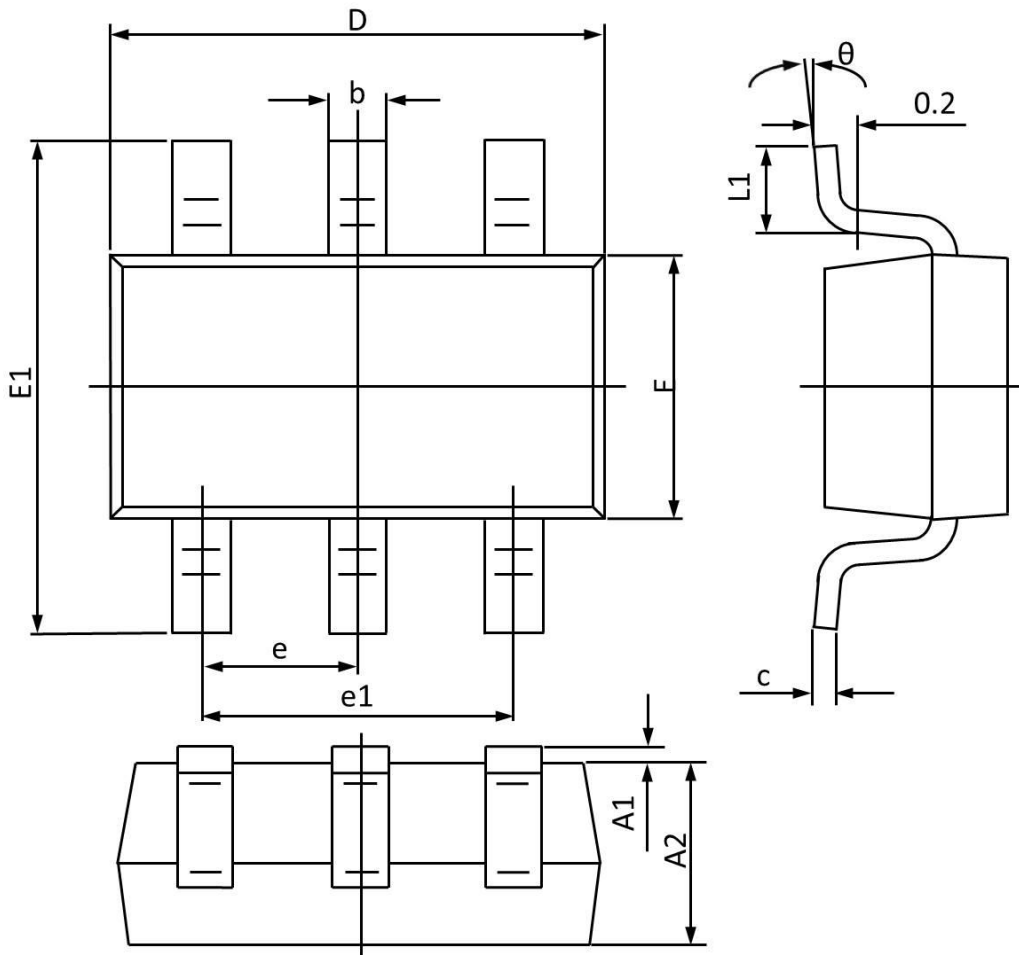

Fig.8 E_{AS} Waveform

Package Outline Dimensions

SOT-23-6L



Symbol	Dimensions In Millimeters		Dimensions In Inches	
	Min	Max	Min	Max
A1	0.000	0.100	0.000	0.004
A2	1.000	1.200	0.040	0.047
b	0.300	0.500	0.012	0.019
c	0.047	0.207	0.002	0.008
D	2.800	3.000	0.110	0.118
E1	2.600	3.000	0.103	0.118
e	0.950 TYP		0.037 TYP	
e1	1.900 TYP		0.075 TYP	
L1	0.250	0.550	0.010	0.021
theta	0°	8°	0°	8°