



SANYO Semiconductors

DATA SHEET

LA47536 — Monolithic Linear IC Four-Channel 45 W BTL Car Audio Power Amplifier

Overview

The LA47536 is a 4-channel BTL power amplifier IC developed for use in car audio systems. The output stage features a pure complimentary structure that uses V-pnp transistors on the high side and npn transistors on the low side to provide high power and superb audio quality.

The LA47536 includes almost all the functions required for car audio use, including a standby switch, a muting function, and each protection circuit. It also provides a self-diagnosis function (output offset detection).

Functions and Features

- Voltage gain: 32 dB
- High output power
 - Pomax(1) = 45 W (typical)
(At $V_{CC} = 14.4$ V, $f = 1$ kHz, $V_i = 2.5$ Vrms, $R_L = 4$ Ω)
 - Pomax(2) = 40 W (typical)
(At $V_{CC} = 13.7$ V, $f = 1$ kHz, $V_i = 2.5$ Vrms, $R_L = 4$ Ω)
 - Po = 28 W (typical)
(At $V_{CC} = 14.4$ V, $f = 1$ kHz, THD = 10%, $R_L = 4$ Ω)
- Muting function (pin 22)
- Standby switch (pin 4)
- Built-in various protection circuits
 - Output pin-to- V_{CC} short
 - Output pin-to-GND short
 - Load short
 - Over voltage
 - Thermal shut down
- Self-diagnosis function that detects the output offset (pin 25)
- Output offset detection on/off switch (pin 1)

■ Any and all SANYO products described or contained herein do not have specifications that can handle applications that require extremely high levels of reliability, such as life-support systems, aircraft's control systems, or other applications whose failure can be reasonably expected to result in serious physical and/or material damage. Consult with your SANYO representative nearest you before using any SANYO products described or contained herein in such applications.

■ SANYO assumes no responsibility for equipment failures that result from using products at values that exceed, even momentarily, rated values (such as maximum ratings, operating condition ranges, or other parameters) listed in products specifications of any and all SANYO products described or contained herein.

SANYO Electric Co., Ltd. Semiconductor Company

TOKYO OFFICE Tokyo Bldg., 1-10, 1 Chome, Ueno, Taito-ku, TOKYO, 110-8534 JAPAN

Specifications

Maximum Ratings at Ta = 25°C

Parameter	Symbol	Conditions	Ratings	Unit
Maximum supply voltage	V _{CC} max1	No signal, t = 1 minute	26	V
	V _{CC} max2	With an input signal applied	18	V
Maximum output current	I _O peak	Per channel	4.5/ch	A
Allowable power dissipation	Pd max	Assuming an infinite heat sink	50	W
Operating temperature	Topr		-40 to +85	°C
Storage temperature	Tstg		-40 to +150	°C
Junction to case thermal resistance	θj-c		1	°C/W

Recommended Operating Conditions at Ta = 25°C

Parameter	Symbol	Conditions	Ratings	Unit
Recommended supply voltage	V _{CC}		14.4	V
Recommended load resistance	R _L op		4	Ω
Operating supply voltage range	V _{CC} op	The range where Pd max is not exceeded	9 to 18	V

Electrical Characteristics at Ta = 25°C, V_{CC} = 14.4 V, R_L = 4 Ω, f = 1 kHz, R_g = 600 Ω

Parameter	Symbol	Conditions	Ratings			Unit
			min	typ	max	
Quiescent current	I _{CCO}	R _L = ∞, R _g = 0		200	400	mA
Standby current	I _{st}	V _{st} = 0			10	μA
Output offset	V _N offset	R _g = 0	-150		+150	mV
Voltage gain	V _G	V _O = 0 dBm	31	32	33	dB
Voltage gain difference	ΔV _G		-1		+1	dB
Output power	P _O 1	THD = 10%	23	28		W
	P _O max1	V _{CC} = 13.7 V, V _{IN} = 2.5 Vrms		40		W
	P _O max2	V _{IN} = 2.5 Vrms		45		W
Total harmonic distortion	THD	P _O = 4 W		0.1	0.4	%
Channel separation	CHsep	V _O = 0 dBm, R _g = 10 kΩ	50	60		dB
Ripple rejection ratio	SVRR	R _g = 0, fr = 100 Hz, V _{ccr} = 0 dBm, 20 Hz to 20 kHz	40	45		dB
Output noise voltage	V _{NO}	R _g = 0, 20 Hz to 20 kHz		300	450	μVrms
Muting attenuation	Ma	V _O = 20 dBm	70	90		dB
Output center point potential	V _N	R _g = 0		2.65		V

Package Dimensions

unit : mm

3236

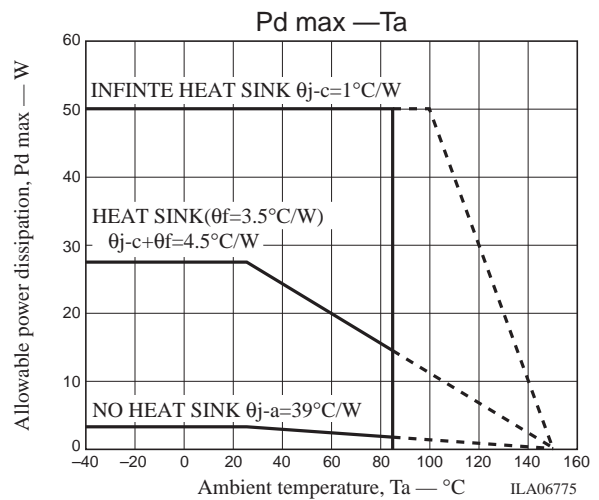
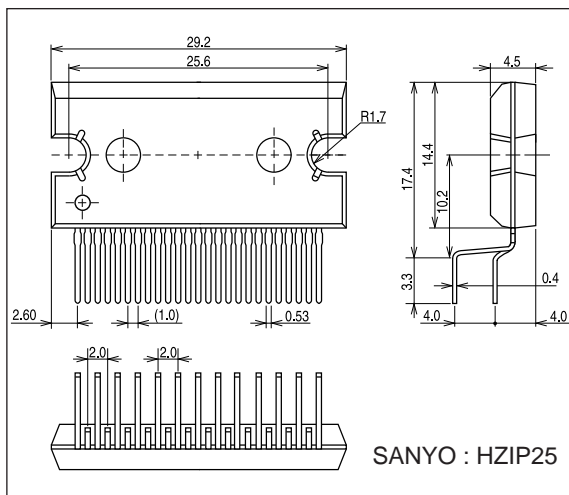

Functional Description

1. Standby Switch Function (pin 4)

The pin 4 threshold voltage is set to be $2 V_{BE}$. When V_{st} is 2.0V or higher, the amplifier will be on, and when V_{st} is 0.7V or lower, the amplifier will be off. Note that pin 4 requires an operating current of at least 40 μ A.

2. Muting Function

The IC is set to the muted state by setting pin 22 to the ground potential. In this state, the audio output is muted. The time constant with which the muting function operates is set by an external RC circuit, and this time constant influences the pop noise that occurs when the amplifier is turned on or off.

The muting on and off times due to the recommended external component values ($R=10k\Omega$, $C=3.3\mu F$) are as follows.

Muting on time: 50ms

Muting off time: 20ms

3. Self-Diagnosis Function (Speaker burnout prevention)

During steady state operation, the LA47536 detects, internally, whether or not an abnormal amplifier output offset has occurred, and outputs this signal from pin 25. Applications can prevent speaker burnout and other problems by having the system microcontroller detect this pin 25 output signal and control either the standby state or the power supply. (An abnormal output offset may be caused by, for example, input capacitor leakage current.)

The pin 25 signal is turned off by setting pin 1 to the ground potential.

4. Oscillator Stability

In some cases, parasitic oscillations may be induced by the PCB layout. This oscillation can be eliminated by adding the components listed below. Note that the optimal capacitor value must be verified by testing in the actual mounted state in the end product.

- Connect a capacitor and resistor (0.1 μ F and 2.2 Ω) in series between each output pin and ground.

5. Audio Quality (Low band)

The frequency characteristics in the low frequencies can be improved by making the capacitance of the input capacitors variable.

The recommended capacitance is 2.2 μ F and smaller.

6. Protection Circuits

Do not ground the outputs with the STBY voltage at around 1.4V. Also, do not turn the IC off in the grounded state with a time constant provided for the STBY voltage.

7. Pop Noise

Although the LA47536 includes a pop noise prevention circuit, pop noise can be reduced even further by using the muting function as well.

- Activate the muting function at the same time as power is applied. Then, after the output DC potential has stabilized, turn off the muting function.
- When turning the amplifier off, first turn on the muting function and then turn off the power supply. These two methods are effective at minimizing pop noise.

Block and Application Diagram

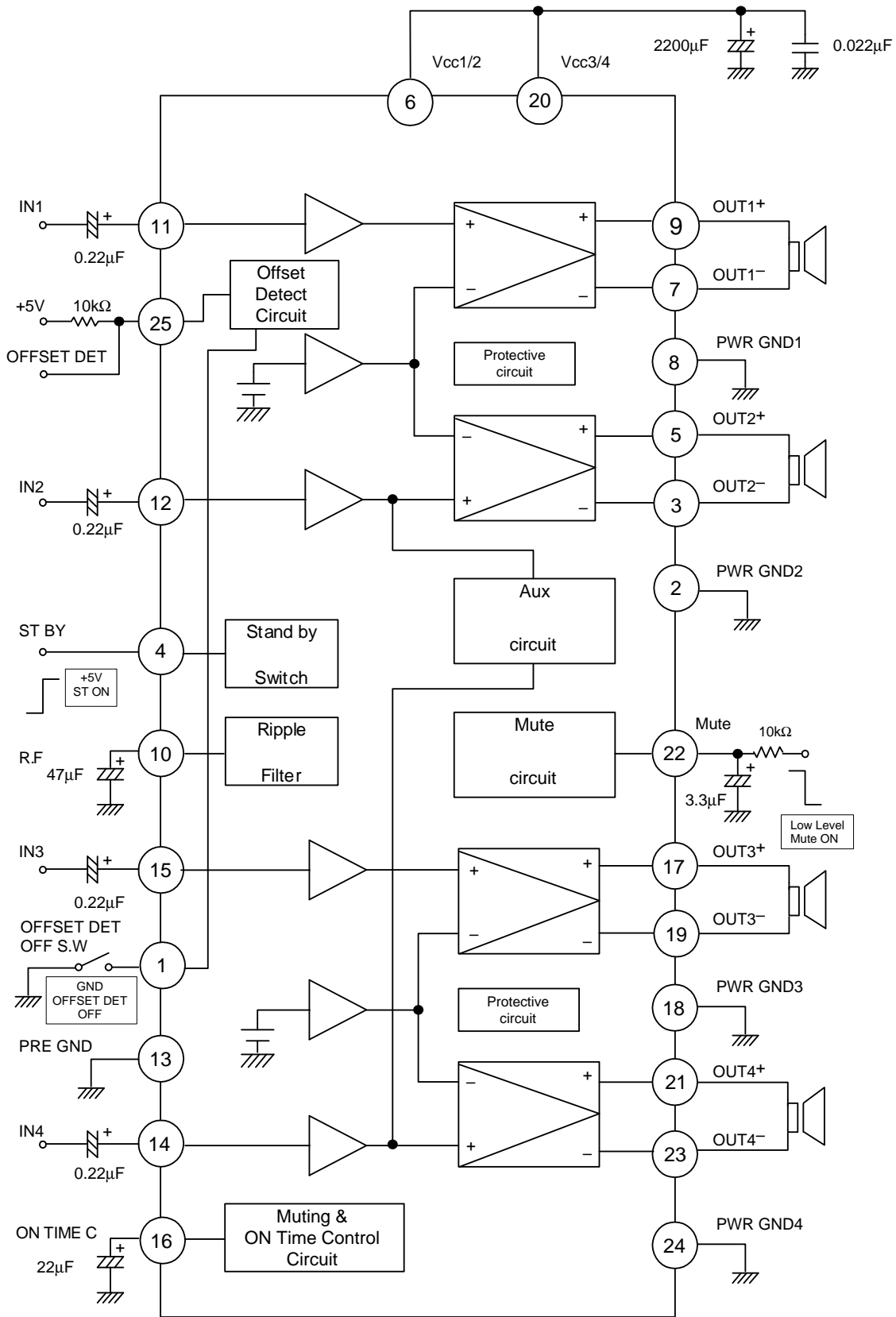

* Package: HZIP25

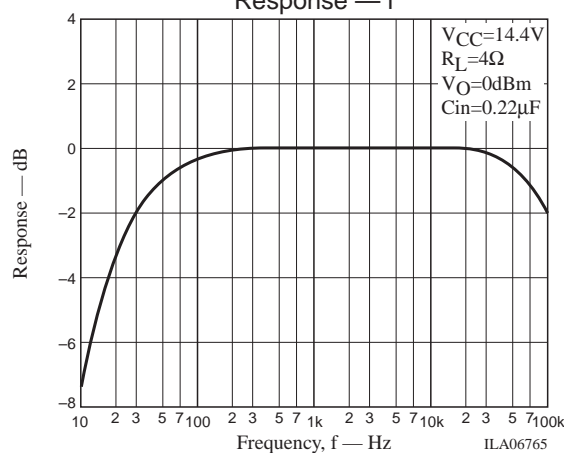
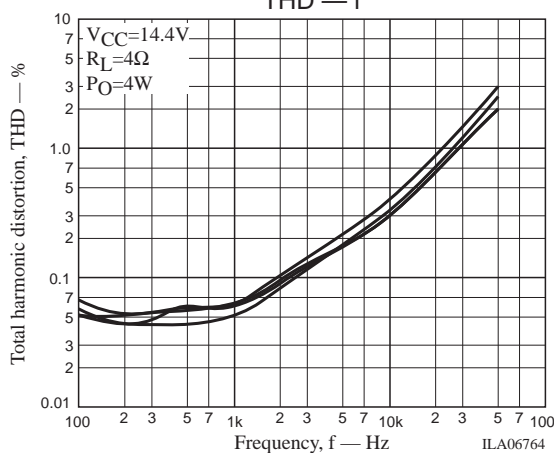
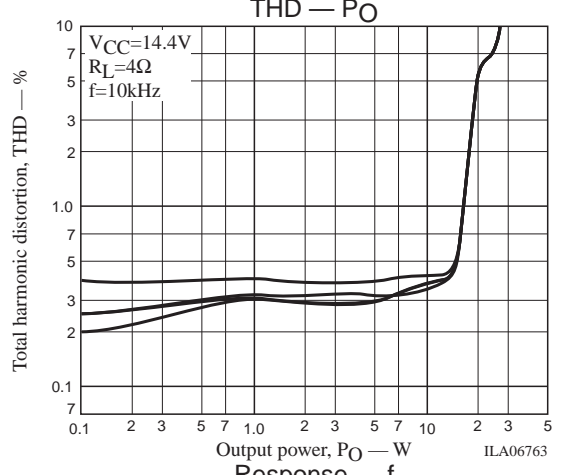
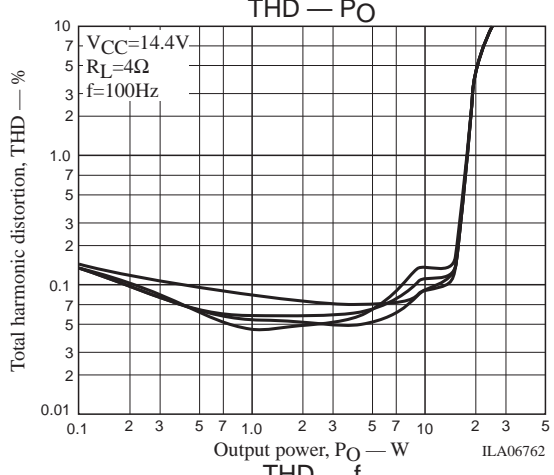
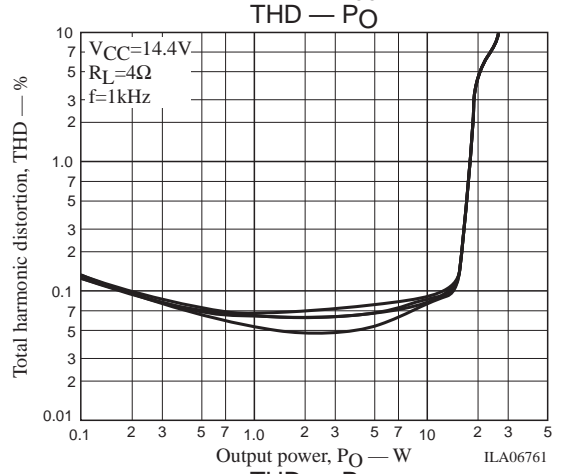
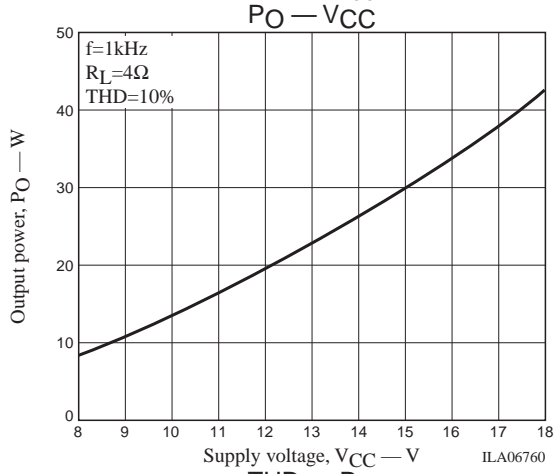
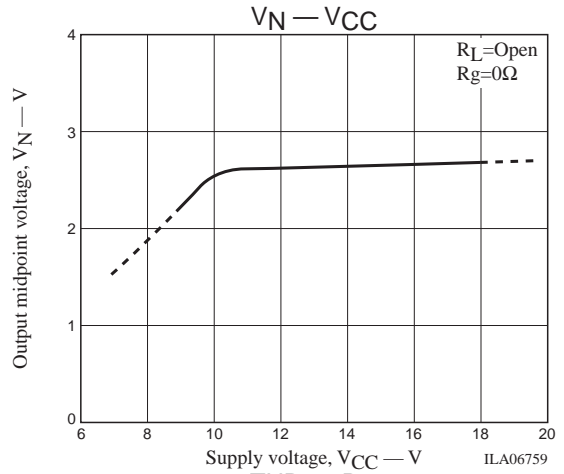
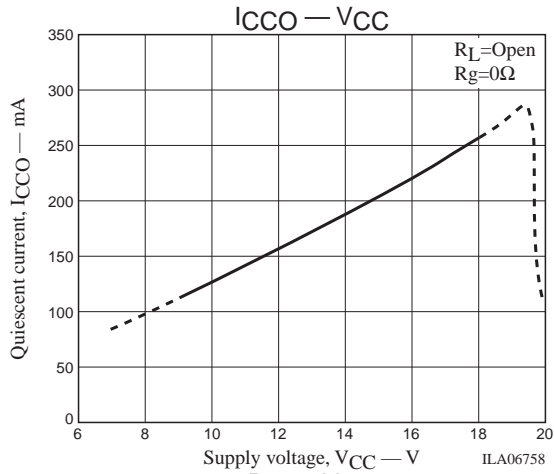

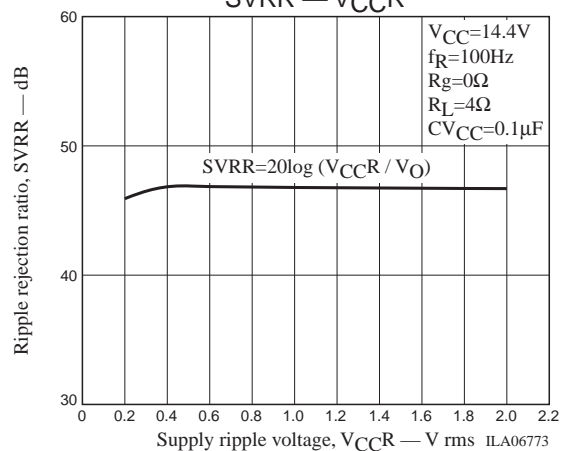
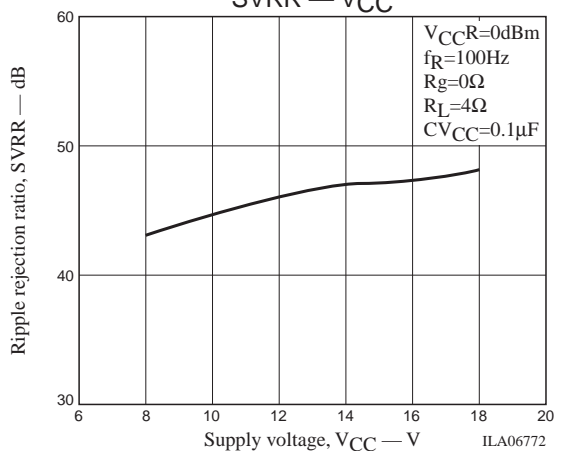
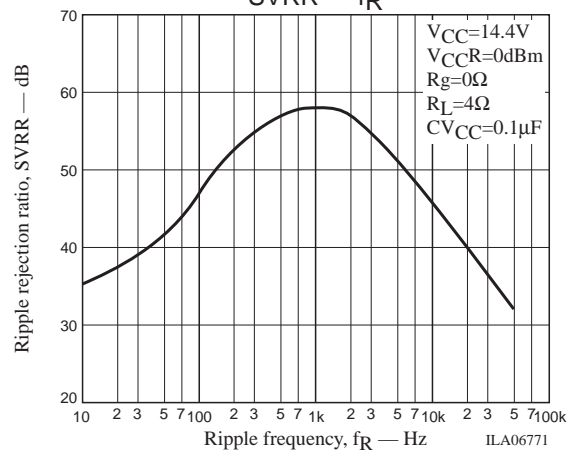
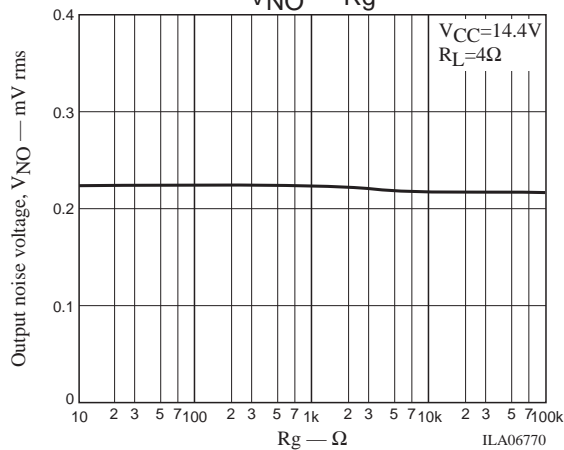
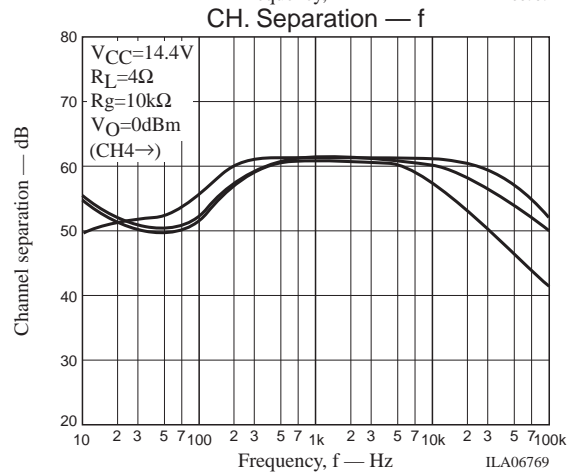
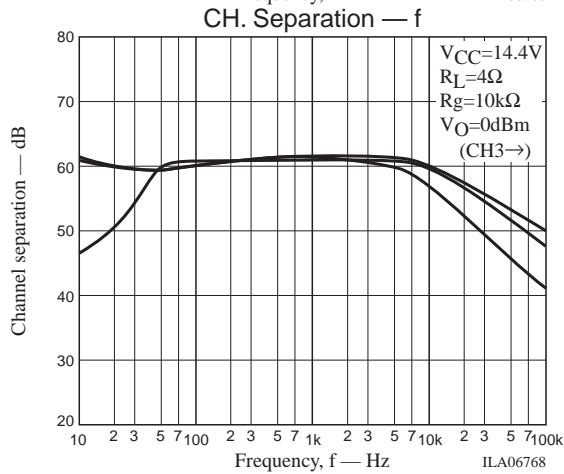
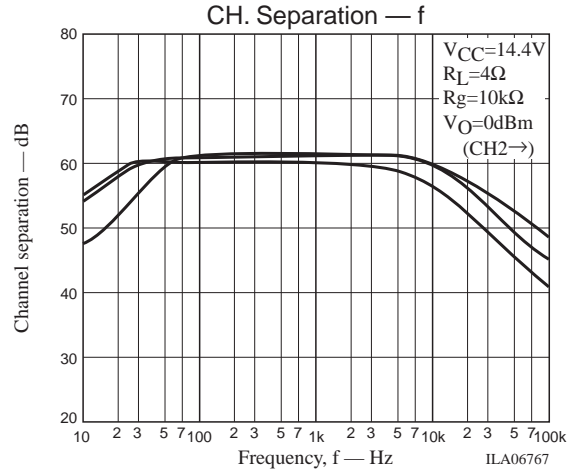
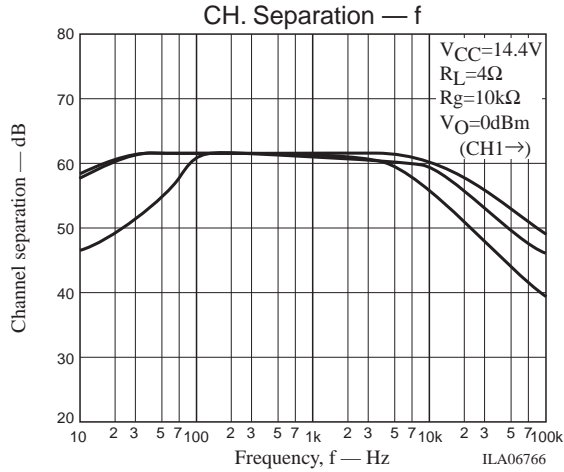

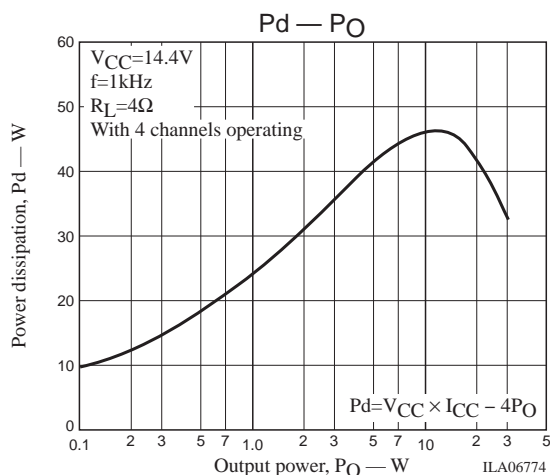

- Specifications of any and all SANYO products described or contained herein stipulate the performance, characteristics, and functions of the described products in the independent state, and are not guarantees of the performance, characteristics, and functions of the described products as mounted in the customer's products or equipment. To verify symptoms and states that cannot be evaluated in an independent device, the customer should always evaluate and test devices mounted in the customer's products or equipment.
- SANYO Electric Co., Ltd. strives to supply high-quality high-reliability products. However, any and all semiconductor products fail with some probability. It is possible that these probabilistic failures could give rise to accidents or events that could endanger human lives, that could give rise to smoke or fire, or that could cause damage to other property. When designing equipment, adopt safety measures so that these kinds of accidents or events cannot occur. Such measures include but are not limited to protective circuits and error prevention circuits for safe design, redundant design, and structural design.
- In the event that any or all SANYO products (including technical data, services) described or contained herein are controlled under any of applicable local export control laws and regulations, such products must not be exported without obtaining the export license from the authorities concerned in accordance with the above law.
- No part of this publication may be reproduced or transmitted in any form or by any means, electronic or mechanical, including photocopying and recording, or any information storage or retrieval system, or otherwise, without the prior written permission of SANYO Electric Co., Ltd.
- Any and all information described or contained herein are subject to change without notice due to product/technology improvement, etc. When designing equipment, refer to the "Delivery Specification" for the SANYO product that you intend to use.
- Information (including circuit diagrams and circuit parameters) herein is for example only; it is not guaranteed for volume production. SANYO believes information herein is accurate and reliable, but no guarantees are made or implied regarding its use or any infringements of intellectual property rights or other rights of third parties.

This catalog provides information as of April, 2004. Specifications and information herein are subject to change without notice.