



SPECIFICATION SHEET

SPECIFICATION SHEET NO.	N0310-SMAFSS14F0S104
DATE	Mar. 10, 2021
REVISION	A0
DESCRIPTION	SMD Schottky Barrier Rectifier, 2 Pads, SMAF series, SS14F Type Reverse Voltage 40V Max. Forward Current 1.0A Max. Operating Temp. Range -50°C ~+125°C Package in Tape/Reel, 3000pcs/Reel RoHS/RoHS III compliant
CUSTOMER	
CUSTOMER PART NUMBER	
CROSS REF. PART NUMBER	
ORIGINAL PART NUMBER	MDD SS14F
PART CODE	SMAFSS14F0S104

VENDOR APPROVE			
Issued/Checked/Approved			
DATE: March 10, 2021			

CUSTOMER APPROVE	
DATE:	

SMD SCHOTTKY BARRIER RECTIFIER SMAF SERIES



MAIN FEATURE

- The plastic package carries Underwriters Laboratory Flammability Classification 94V-0
- Low power loss and high efficiency
- Built-in strain relief,
- High forward surge current capability
- Metal silicon junction, majority carrier conduction
- High temperature soldering guaranteed: 250°C/ 10 seconds at terminals

APPLICATION

- For surface mounted applications

RFQ

[Request For Quotation](#)

PART CODE GUIDE

SMAF	SS14F0	S	104
1	2	3	4

- 1) **SMAF**: SMD Schottky Barrier Rectifier, 2 Pads, Package SMAF series,
- 2) **SS14F0**: Type code for original part number SS14F
- 3) **S**: Package code, Tape/reel, 3000pcs/reel.
- 4) **104**: Specification code for Reverse Voltage 40V Max. Forward Current 1.0A Max.

MORE ITEMS AVAILABLE

SMAFSS12F0S102	SMAFSS13F0S103	SMAFSS14F0S104	SMAFSS15F0S105	SMAFSS16F0S106
SMAFSS18F0S108	SMAFSS1100S110	SMAFSS1150S115	SMAFSS1200S120	
SMAFSS22F0S202	SMAFSS23F0S203	SMAFSS24F0S204	SMAFSS25F0S205	SMAFSS26F0S206
SMAFSS28F0S208	SMAFSS2100S210	SMAFSS2150S215	SMAFSS2200S220	
SMAFSS32F0S302	SMAFSS33F0S303	SMAFSS34F0S304	SMAFSS35F0S305	SMAFSS36F0S306
SMAFSS38F0S308	SMAFSS3100S310	SMAFSS3150S315	SMAFSS3200S320	
SMAFSS52F0S502	SMAFSS53F0S503	SMAFSS54F0S504	SMAFSS55F0S505	SMAFSS56F0S506
SMAFSS58F0S508	SMAFSS5100S510	SMAFSS5150S515	SMAFSS5200S520	

SMD SCHOTTKY BARRIER RECTIFIER SMAF SERIES

DIMENSION (Unit: Inch/mm)

Image for reference



Marking: SS14F

SMAF

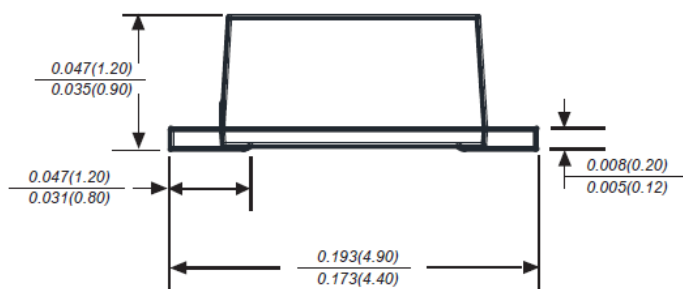
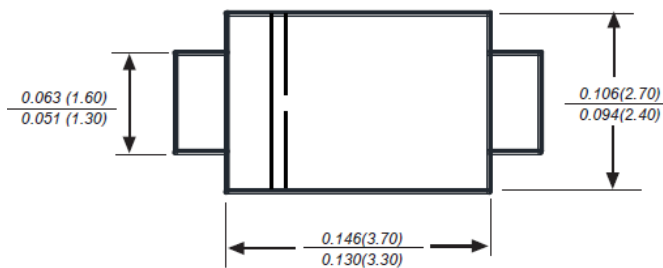

Recommend Pad Layout

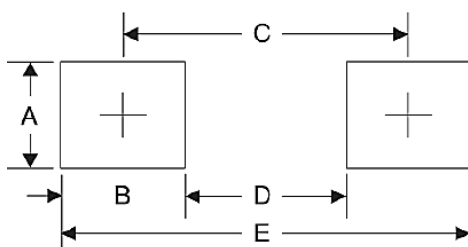

Symbol	Unit (Inch)	Unit (mm)
A	0.071	1.80
B	0.063	1.60
C	0.150	3.80
D	0.087	2.21
E	0.213	5.40

SMD SCHOTTKY BARRIER RECTIFIER SMAF SERIES

MECHANICAL DATA

Case	Terminals	Polarity	Mounting Position	Weight per piece
JEDEC SMAF molded plastic body	Solder plated, Solderable per MIL-STD-750, Method 2026	Color band denotes cathode end	Any	0.0018 Ounce, 0.0510 grams

MAX. RATING & CHARACTERISTICS

Parameter	SYMBOLS	VALUE			UNITS
		Min.	Typical	Max.	
Repetitive peak reverse voltage	V_{RRM}			40	Volts
RMS voltage	V_{RMS}			28	Volts
DC blocking voltage	V_{DC}			40	Volts
Average forward output rectified current at TL(see fig.1)	I_{AV}			1.0	A
Peak forward surge current 8.3ms single half sine-wave superimposed on rated load (JEDEC Method)	I_{FSM}		30		A
Instantaneous forward voltage at 1.0A	V_F			0.55	Volts
DC reverse current at rated DC blocking voltage		I_R		0.50	mA
				10.0	mA
Junction capacitance (Note 2)	C_J		110		pF
Thermal resistance (Note 3)	R_{QJA}		88		°C/W
Operating junction temperature range	T_J	-55		+125	°C
Storage temperature range	T_{STG}	-55		+150	°C

Note

1. Ratings at 25 C ambient temperature unless otherwise specified. Single phase half-wave 60Hz, resistive or inductive load, for capacitive load current derate by 20%.
2. Measured at 1.0MHz and applied reverse voltage of 4.0Voltage
3. P.C.B. mounted with 0.2x0.2"(5.0x5.0mm) copper pad areas.

SMD SCHOTTKY BARRIER RECTIFIER SMAF SERIES
RELIABILITY

Number	Experiment Items	Experiment Method And Conditions	Reference Documents
1	Solder Resistance Test	Test 260°C± 5°C for 10 ± 2 sec. Immerse body into solder 1/16" ± 1/32"	MIL-STD-750D METHOD-2031.2
2	Solderability Test	230°C ±5°C for 5 sec.	MIL-STD-750D METHOD-2026.1 0
3	Pull Test	1 kg in axial lead direction for 10 sec.	MIL-STD-750D METHOD-2036.4
4	Bend Test	0.5Kg Weight Applied To Each Lead, Bending Arcs 90 °C ± 5 °C For 3 Times	MIL-STD-750D METHOD-2036.4
5	High Temperature Reverse Bias Test	TA=100°C for 1000 Hours at VR=80% Rated VR	MIL-STD-750D METHOD-1038.4
6	Forward Operation Life Test	TA=25°C Rated Average Rectified Current	MIL-STD-750D METHOD-1027.3
7	Intermittent Operation Life Test	On state: 5 min with rated IRMS Power Off state: 5 min with Cool Forced Air. On and off for 1000 cycles.	MIL-STD-750D METHOD-1036.3
8	Pressure Cooker Test	15 PSIG, TA=121°C, 4 hours	MIL-S-19500 APPENOIXC
9	Temperature Cycling Test	-55°C~+125°C; 30 Minutes For Dwelled Time 5 minutes for transferred time. Total: 10 cycles.	MIL-STD-750D METHOD-1051.7
10	Thermal Shock Test	0°C for 5 minutes., 100°C for 5minutes, Total: 10 cycles	MIL-STD-750D METHOD-1056.7
11	Forward Surge Test	8.3ms Single Sale Sine-wave One Surge.	MIL-STD-750D METHOD-4066.4
12	Humidity Test	TA=65°C, RH=98% for 1000 hours.	MIL-STD-750D METHOD-1021.3
13	High Temperature Storage life Test	150°C for 1000 Hours	MIL-STD-750D METHOD-1031.5

SMD SCHOTTKY BARRIER RECTIFIER SMAF SERIES

SUGGESTED REFLOW PROFILE (For Reference Only)

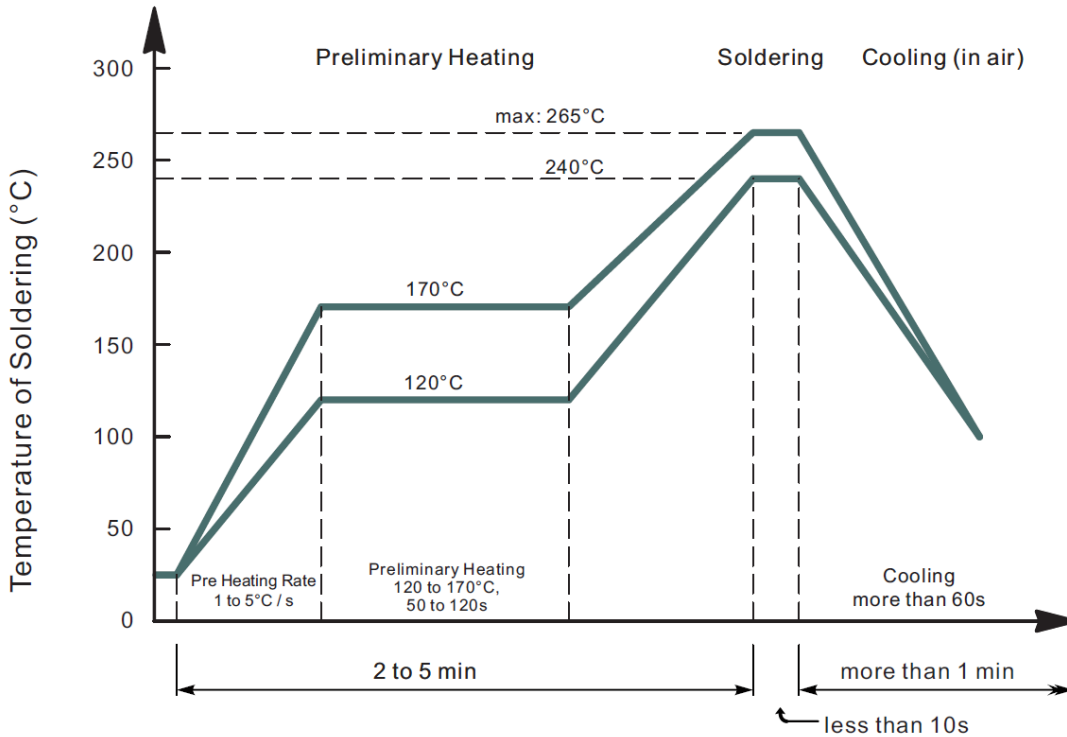

- Recommended peak temperature is over 245°C, If peak temperature is below 245 °C, you may adjust the following parameters; time length of peak temperature (longer), time length of soldering (longer), thickness of solder paste (thicker)
- Welding shall not exceed 2 times
- Remark: lead free solder paste (96.5 sn/3.0 Ag/0.5Cu)

SMD SCHOTTKY BARRIER RECTIFIER SMAF SERIES

RATINGS AND CHARACTERISTIC CURVES (For Reference Only)

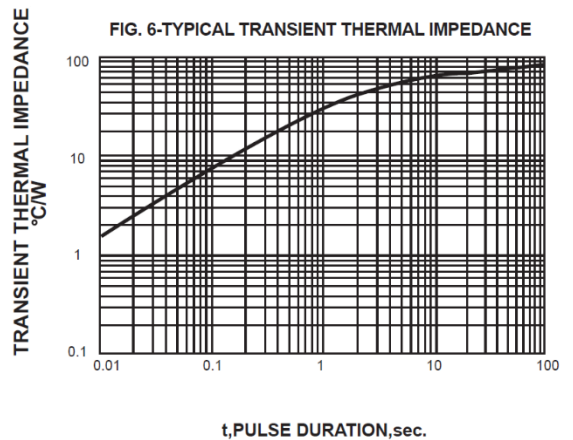
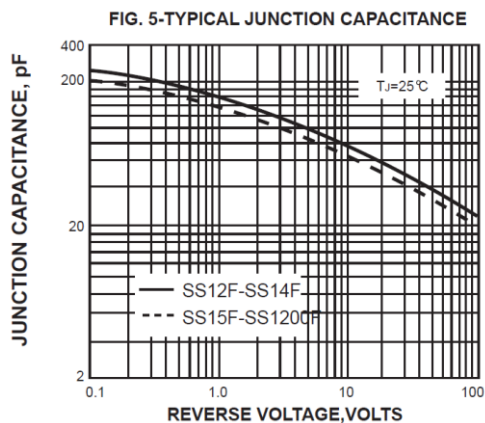
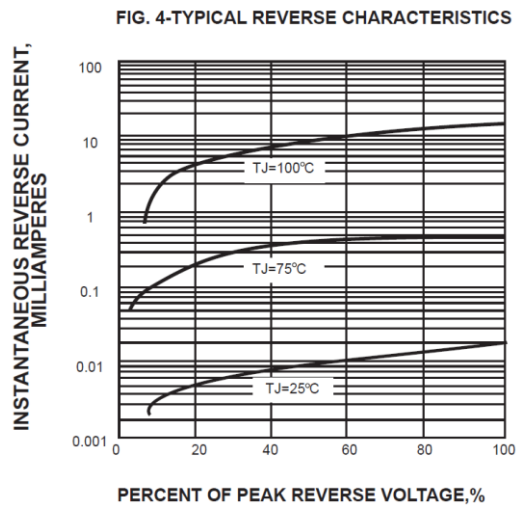
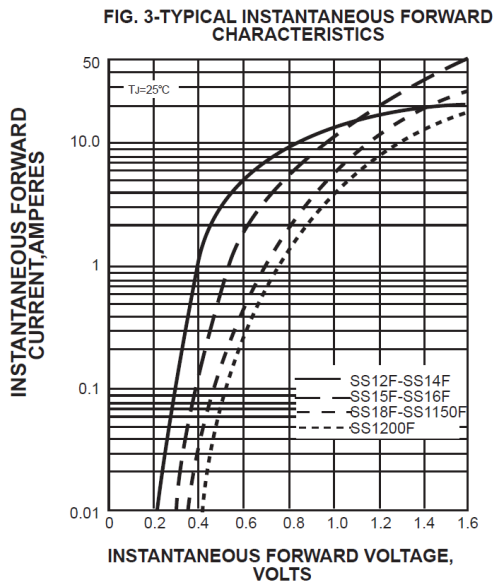
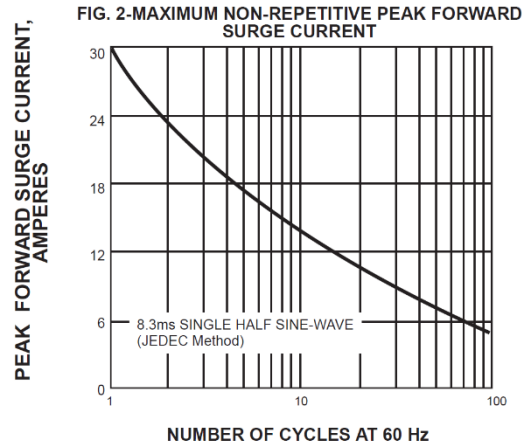
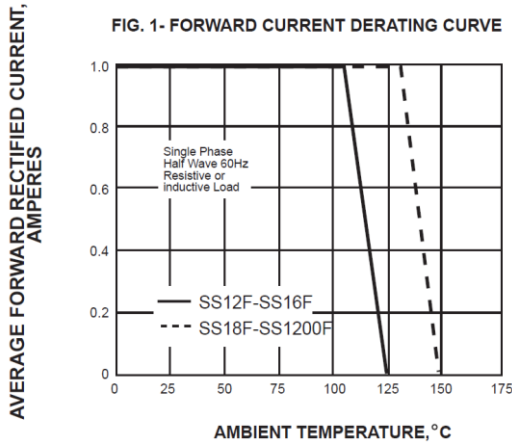

SMD SCHOTTKY BARRIER RECTIFIER SMAF SERIES

TAPE/REEL (Unit: mm)

All Devices are packed in accordance with EIA standard RS-481-A and specifications.

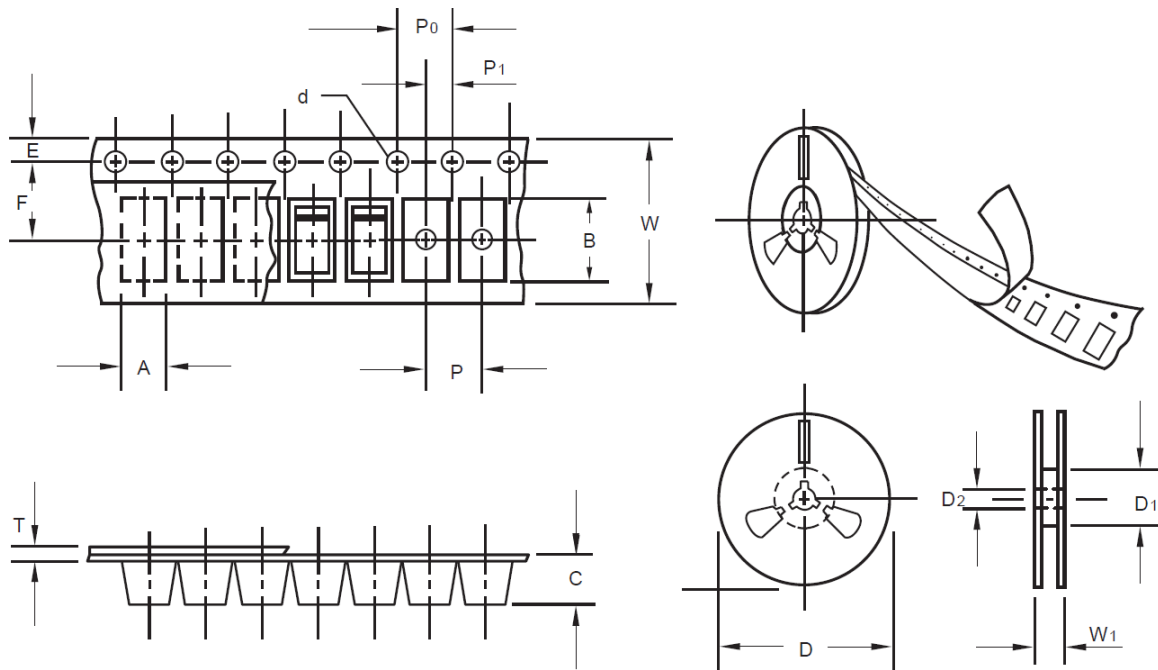

Item	Symbol	Tolerance	SMAF
Carrier width	A	0.1	2.80
Carrier Length	B	0.1	4.75
Carrier Depth	C	0.1	1.42
Sprocket hole	d	0.05	1.50
7" Reel outside diameter	D	2.0	178.00
7" Reel inner diameter	D1	Min.	54.40
Feed hole diameter	D2	0.5	13.00
Sprocket hole position	E	0.1	1.75
Punch hole position	F	0.1	5.05
Punch hole pitch	P	0.1	4.00
Sprocket hole pitch	P0	0.1	4.00
Embossment center	P1	0.1	2.00
Overall tape thickness	T	0.1	0.30
Tape width	W	0.3	8.00
Reel width	W1	1.0	12.30

SMD SCHOTTKY BARRIER RECTIFIER SMAF SERIES

PACKAGE

Case Code	Reel Size	MPQ (pcs)	Component Spacing (mm)	Qty. Per Box (pcs)	Inner Box L*W*H (mm)	Reel Size (mm)	Carton size L*W*H (mm)	Qty. Per Carton (pcs)	G. W (kg)
SMAF	7"	3,000		6,000	210*208*203	178	400*400*250	120,000	10.0

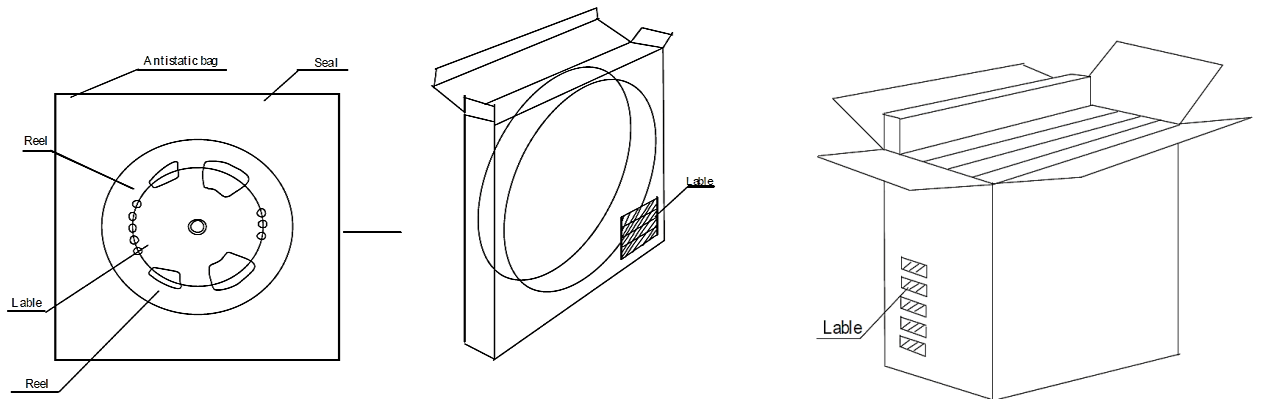

DISCLAIMER

NextGen Component, Inc. reserves the right to make changes to the product(s) and or information contained herein without notice. No liability is assumed as a result of their use or application. No rights under any patent accompany the sale of any such product(s) or information