



SPECIFICATION SHEET

SPECIFICATION SHEET NO.	N0929- SOD123AV21WST3
DATE	Sept. 29, 2021
REVISION	A0
DESCRIPTION	SMD Small Signal Fast Switching diodes, SOD-123 series, 2 pads Reverse Voltage 250V Max. Forward Current 250mA Max. Operating Temp. Range -55°C ~+150°C, Package in Tape/Reel, 3000pcs/Reel RoHS/RoHS III compliant
CUSTOMER	
CUSTOMER PART NUMBER	
CROSS REF. PART NUMBER	
ORIGINAL PART NUMBER	MDD BAV21W
PART CODE	SOD123AV21WST3

VENDOR APPROVE			
Issued/Checked/Approved			
DATE: Sept. 29, 2021			

CUSTOMER APPROVE	
DATE:	

SMD FAST SWITCHING DIODES SOD123 SERIES

MAIN FEATURE

- Fast switching speed
- Glass Passivated Chip Junction
- Fast reverse recovery time
- High conductance



APPLICATION

- For general purpose switching applications

RFQ

[Request For Quotation](#)

PART CODE GUIDE

SOD123	AV21W	S	T3
1	2	3	4

- 1) **SOD123**: SMD Small Signal Fast Switching diodes, 2 pads, SOD-123 series
- 2) **AV21W**: Type code for original part number BAV21W
- 3) **S**: Package code, Tape/reel, 3000pcs/reel.
- 4) **T3**: Marking code for "T3" on the case surface, Different Marking for different specification.

MORE ITEMS AVAILABLE

SOD123AV19WSA8	SOD123AV20WST2	SOD123AV21WST3		

SMD FAST SWITCHING DIODES SOD123 SERIES

DIMENSION (Unit: Inch/mm)

Image for reference



Marking: T3

SOD-123

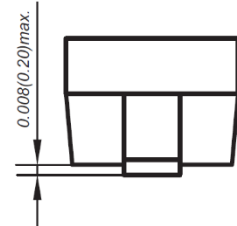
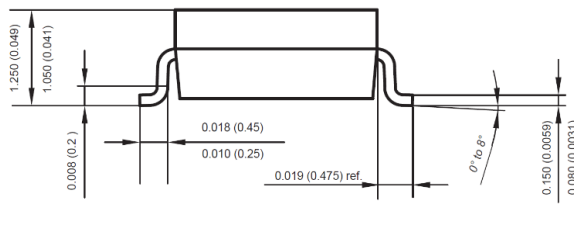
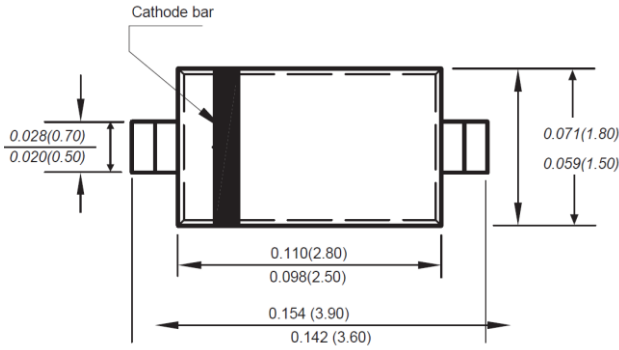

Recommend Pad Layout

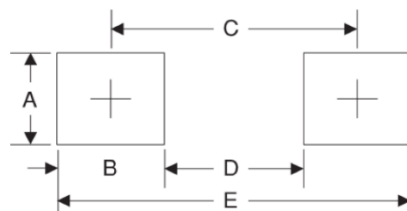

Symbol	Unit (inch)	Unit (mm)
A	0.047	1.20
B	0.047	1.20
C	0.126	3.20
D	0.079	2.00
E	0.173	4.40

SMD FAST SWITCHING DIODES SOD123 SERIES
MECHANICAL DATA

Case	Terminals	Polarity	Mounting Position	Weight per piece
JEDEC SOD-123 molded plastic body	Solder plated, Solderable per MIL-STD-750, Method 2026	Polarity symbol marking on case	Any	0.0007 Ounce, 0.0021 grams

ABSOLUTE MAX. RATING AT 25 °C

Parameter	SYMBOLS	VALUE			UNITS
		Min.	Typical	Max.	
Repetitive peak reverse voltage Working peak reverse Voltage DC Blocking Voltage Non-Repetitive Peak Reverse Voltage	V_{RRM} V_{RWM} V_R V_{RM}			250	Volts
RMS Reverse Voltage	$V_{R(RMS)}$			141	Volts
Forward Continuous Current	I_{FM}			250	mA
Average Rectified Output Current	I_O			200	mA
Peak forward surge current	@ = 1s	I_{FSM}		1	A
	@ = 1 ms			3	
	@ = 1 μ s			9	
Repetitive Peak Forward Current	I_{FRM}			625	mA
Power Dissipation	P_d			500	mW
Thermal Resistance Junction to Ambient	$R_{\theta JA}$			500	
Operating Junction temperature range	T_J	-55		+150	°C
Storage temperature range	T_{STG}	-55		+150	°C

CHARACTERISTICS AT Ta= 25 °C

Parameter	SYMBOLS	VALUE			UNIT	Condition
		Min.	Typ.	Max.		
Reverse Current	I_R			0.1	μ A	at $V_R = 250$ V
Forward Voltage	V_F			1	V	$I_F = 100$ mA
				1.25		$I = 200$ mA
Capacitance between terminals	C_{tot}			5	pF	$V_R = 4$ V, $f = 1.0$ MHz
Reverse recovery time	t_{rr}			50	ns	$I_F = I_R = 10$ mA $I_{rr} = 0.1 I_{I_R}$, $R_L = 100 \Omega$

SMD FAST SWITCHING DIODES SOD123 SERIES

RELIABILITY

Number	Experiment Items	Experiment Method And Conditions	Reference Documents
1	Solder Resistance Test	Test 260°C± 5°C for 10 ± 2 sec. Immerse body into solder 1/16" ± 1/32"	MIL-STD-750D METHOD-2031.2
2	Solderability Test	230°C ±5°C for 5 sec.	MIL-STD-750D METHOD-2026.1 0
3	Pull Test	1 kg in axial lead direction for 10 sec.	MIL-STD-750D METHOD-2036.4
4	Bend Test	0.5Kg Weight Applied To Each Lead, Bending Arcs 90 °C ± 5 °C For 3 Times	MIL-STD-750D METHOD-2036.4
5	High Temperature Reverse Bias Test	TA=100°C for 1000 Hours at VR=80% Rated VR	MIL-STD-750D METHOD-1038.4
6	Forward Operation Life Test	TA=25°C Rated Average Rectified Current	MIL-STD-750D METHOD-1027.3
7	Intermittent Operation Life Test	On state: 5 min with rated IRMS Power Off state: 5 min with Cool Forced Air. On and off for 1000 cycles.	MIL-STD-750D METHOD-1036.3
8	Pressure Cooker Test	15 PSIG, TA=121°C, 4 hours	MIL-S-19500 APPENOIXC
9	Temperature Cycling Test	-55°C~+125°C; 30 Minutes For Dwelled Time 5 minutes for transferred time. Total: 10 cycles.	MIL-STD-750D METHOD-1051.7
10	Thermal Shock Test	0°C for 5 minutes., 100°C for 5minutes, Total: 10 cycles	MIL-STD-750D METHOD-1056.7
11	Forward Surge Test	8.3ms Single Sale Sine-wave One Surge.	MIL-STD-750D METHOD-4066.4
12	Humidity Test	TA=65°C, RH=98% for 1000 hours.	MIL-STD-750D METHOD-1021.3
13	High Temperature Storage life Test	150°C for 1000 Hours	MIL-STD-750D METHOD-1031.5

SMD FAST SWITCHING DIODES SOD123 SERIES

SUGGESTED REFLOW PROFILE (For Reference Only)

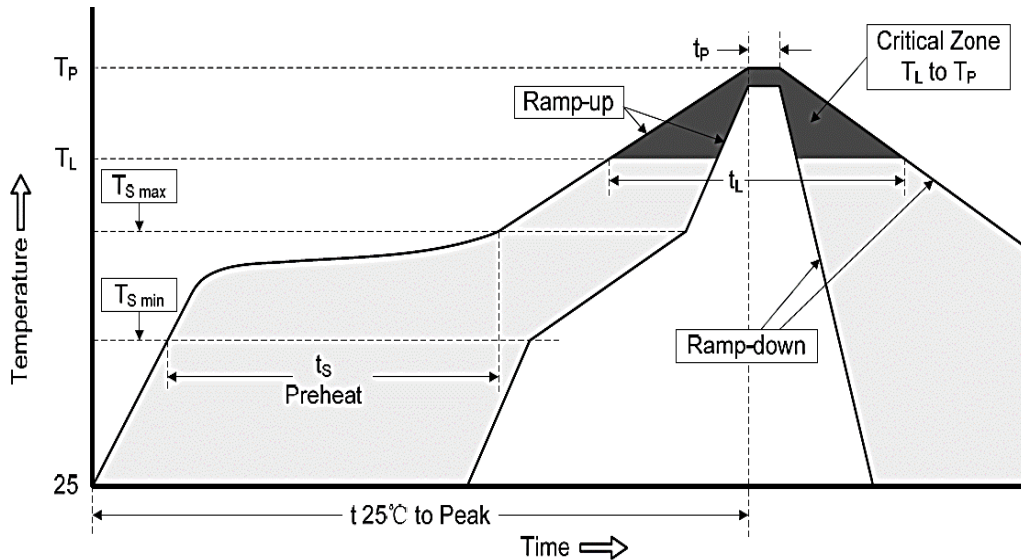

Profile Feature		Pb-Free Assembly
Average Ramp-up Rate (Ts Max to Tp)		3°C/second Max
Preheat	Temperature Min (Ts Min.)	150°C
	Temperature Max (Ts Max.)	200°C
	Time (ts Min. to ts Max.)	60 ~ 180 seconds
Time maintained above	Temperature (Tl)	217°C
	Time (ti)	60 ~ 150 seconds
Peak/Classification Temperature (Tp)		260 °C
Time within 5°C of actual Peak Temperature (tp)		20 ~ 40 seconds
Ramp-down rate		6 °C /Second Max.
Time 25 °C to Peak Temperature		8 minutes Max.
Suggest reflow times		3 Times Max.

SMD FAST SWITCHING DIODES SOD123 SERIES

RATINGS AND CHARACTERISTIC CURVES (For Reference Only)

Fig.1 Power Derating Curve

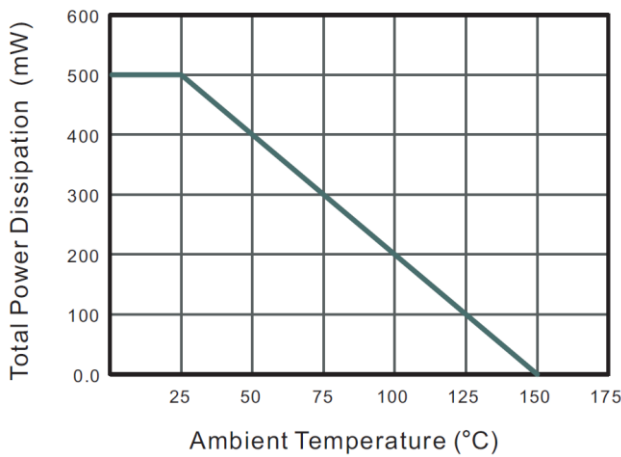

Fig.2 Typical Reverse Characteristics

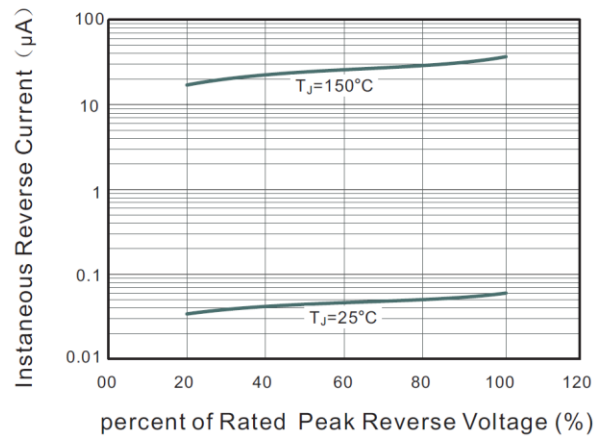

Fig.3 Typical Instantaneous Forward Characteristics

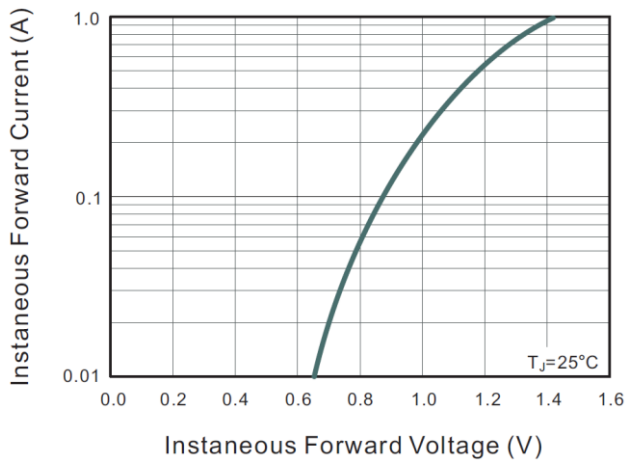
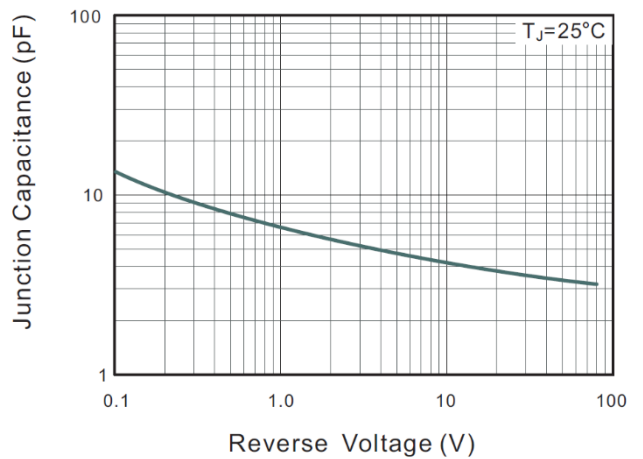

Fig.4 Typical Junction Capacitance



SMD FAST SWITCHING DIODES SOD123 SERIES

TAPE/REEL (Unit: mm)

All Devices are packed in accordance with EIA standard RS-481-A and specifications.

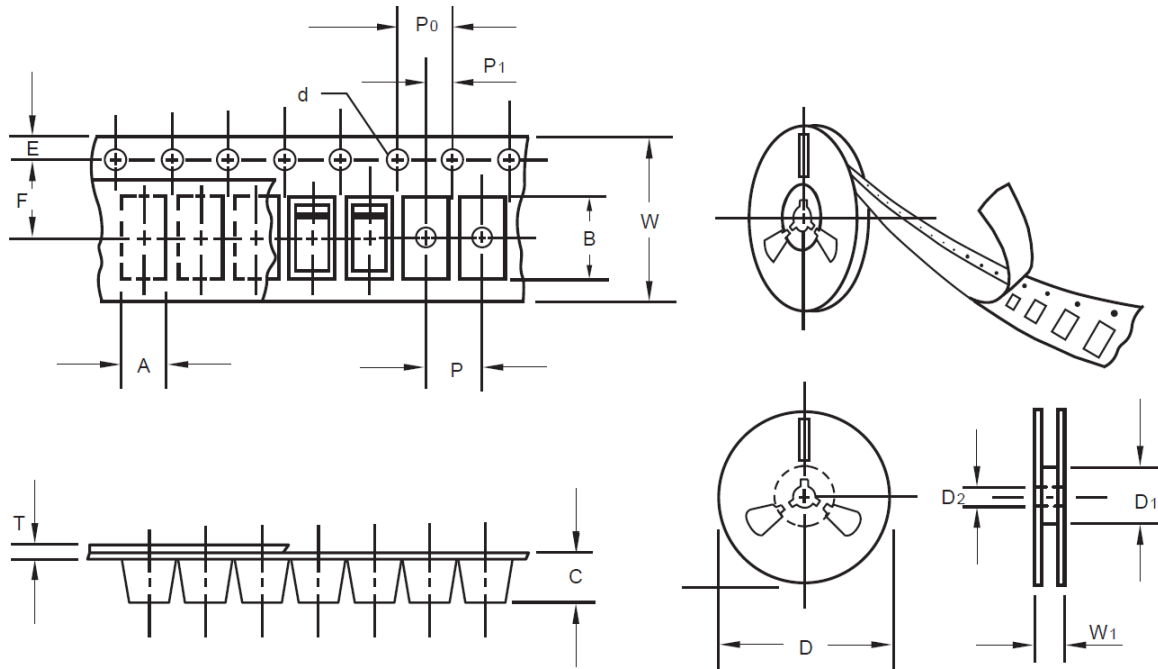

Item	Symbol	Tolerance	SO-123
Carrier width	A	0.1	2.10
Carrier Length	B	0.1	4.00
Carrier Depth	C	0.1	1.60
Sprocket hole	d	0.05	1.55
13" Reel outside diameter	-	-	-
13" Reel inner diameter	-	-	-
7" Reel outside diameter	D	2.0	178.00
7" Reel inner diameter	D1	Min.	50.00
Feed hole diameter	D2	0.5	13.00
Sprocket hole position	E	0.1	1.75
Punch hole position	F	0.1	3.50
Punch hole pitch	P	0.1	4.00
Sprocket hole pitch	P0	0.1	4.00
Embossment center	P1	0.1	2.00
Overall tape thickness	T	0.1	0.25
Tape width	W	0.3	8.15
Reel width	W1	1.0	10.50

SMD FAST SWITCHING DIODES SOD123 SERIES

SPQ PACKAGE for Reference

Item	Unit	Value
Case Code		SOD-123
Reel Size	Inch	7
Reel Size	mm	178
Tape Space	mm	/
SPQ /Reel	pcs	3000
Weigh /SPQ	LBs	0.22
Weigh /SPQ	KGs	0.1
Qty. Per Box	pcs	6,000
Inner Box	Inch	L8.0*W8.0*H1.5

DISCLAIMER

NextGen Component, Inc. reserves the right to make changes to the product(s) and or information contained herein without notice. No liability is assumed as a result of their use or application. No rights under any patent accompany the sale of any such product(s) or information