



SANYO Semiconductors

DATA SHEET

LA47202P — Monolithic Linear IC Four-Channel BTL Power Amplifier for Car Audio Systems

Overview

The LA47202P is a 4-channel BTL power amplifier IC developed for use in car audio applications. The LA47202P adopts a pure complementary output stage circuit structure with a v-pnp transistor for the high side and an npn transistor for the low side to provide both high output power and high quality sound.

The LA47202P integrates all the functions required for car audio applications on the same chip, including a standby switch, a muting function, and a full complement of protection circuits. It also features a self diagnostics function.

Functions

- High output : P_O max = 47W (typ.) ($V_{CC} = 14.4V$, $f = 1kHz$, JEITA max, $R_L = 4\Omega$)
 : P_O max = 29W (typ.) ($V_{CC} = 14.4V$, $f = 1kHz$, THD = 10%, $R_L = 4\Omega$)
 : P_O max = 22W (typ.) ($V_{CC} = 14.4V$, $f = 1kHz$, THD = 1%, $R_L = 4\Omega$)
- Muting function incorporated (pin 22)
- Built-in standby switch (pin 4)
- Self diagnostics function incorporated (pin 25) :
 Output of both output offset detection, shorting to V_{CC} or ground and load shorting signals
- Electric mirror noise decrease
- Full compliment of protection circuits (shorting to V_{CC} , shorting to ground, load shorting, overvoltage, and thermal protection).
- Improved oscillation stability

Note 1 : Take care to avoid wrong connection. Otherwise, IC or equipment may suffer breakdown, damage, or deterioration.

Note 2 : The protective circuit function is to avoid the abnormal state (wrong connection of the output) temporarily and does not guarantee that IC is not broken.

These protective functions do not operate outside the operation guarantee range, and wrong connection of output may cause breakdown of IC.

Note 3 : External parts, such as the anti-oscillation part, diode to prevent breakdown, may become necessary depending on the set condition. Check their necessity for each set.

■ Any and all SANYO Semiconductor products described or contained herein do not have specifications that can handle applications that require extremely high levels of reliability, such as life-support systems, aircraft's control systems, or other applications whose failure can be reasonably expected to result in serious physical and/or material damage. Consult with your SANYO Semiconductor representative nearest you before using any SANYO Semiconductor products described or contained herein in such applications.

■ SANYO Semiconductor assumes no responsibility for equipment failures that result from using products at values that exceed, even momentarily, rated values (such as maximum ratings, operating condition ranges, or other parameters) listed in products specifications of any and all SANYO Semiconductor products described or contained herein.

SANYO Semiconductor Co., Ltd.

TOKYO OFFICE Tokyo Bldg., 1-10, 1 Chome, Ueno, Taito-ku, TOKYO, 110-8534 JAPAN

LA47202P

Specifications

Maximum Ratings at Ta = 25°C

Parameter	Symbol	Conditions	Ratings	Unit
Maximum supply voltage	V _{CC} max1	Without signal, t = 1 minute	26	V
	V _{CC} max2	When operating	18	V
Maximum output current	I _O peak	Per channel	4.5	A
Allowable power dissipation	P _d max	With an infinitely large heat sink	50	W
Operating temperature	T _{opr}		-40 to +85	°C
Storage temperature	T _{stg}		-40 to +150	°C
Thermal resistance between junction cases	θ _{j-c}		1	°C/W

Note) The relationship between the power dissipation (Pd) and the junction-to-case thermal resistance (θ_{j-c}), heat sink thermal resistance (θ_f) and junction temperature (T_j), case temperature (T_c), and ambient temperature (T_a) is as expressed by the following equation :

$$T_j = P_d (\theta_{j-c} + \theta_f) + T_a$$

$$= P_d \times \theta_{j-c} + T_c, \quad *T_c = P_d \times \theta_f + T_a$$

Note that T_j max must be limited with T_{stg} max (150°C).

Recommended Operating Ranges at Ta = 25°C

Parameter	Symbol	Conditions	Ratings	Unit
Recommended supply voltage	V _{CC}		14.4	V
Recommended load resistance	R _L		4	Ω
Operating supply voltage range	V _{CC} op	Range not exceeding P _d max	9 to 16	V

Electrical Characteristics at Ta = 25°C, V_{CC} = 14.4V, R_L = 4Ω, f = 1kHz, R_g = 600Ω

Parameter	Symbol	Conditions	Ratings			Unit
			min	typ	max	
Quiescent current	I _{CCO}	R _L = ∞, R _g = 0		200	400	mA
Standby current	I _{st}	V _{st} = 0V			10	μA
Voltage gain	V _G	V _O = 0dBm	25	26	27	dB
Voltage gain difference	ΔV _G		-1		+1	dB
Output power	P _O	THD = 10%	24	29		W
	P _O max1	V _{CC} = 13.7V, JEITA max		42		W
	P _O max2	JEITA max		47		W
Output offset voltage	V _{noffset}	R _g = 0	-150		+150	mV
Total harmonic distortion	THD	P _O = 4W		0.05	0.3	%
Channel separation	CHsep	V _O = 0dBm, R _g = 10kΩ	55	65		dB
Ripple rejection ratio	SVRR	R _g = 0, f _r = 100Hz, V _{CC} R = 0dBm	45	60		dB
Output noise voltage	V _{NO}	R _g = 0, BPF = 20Hz to 20kHz		100	200	μVrms
Input resistance	R _i			50		kΩ
Mute attenuation	Matt	V _O = 20dBm, mute : on	65	80		dB

* 0dBm = 0.775Vrms

LA47202P

Block Diagram

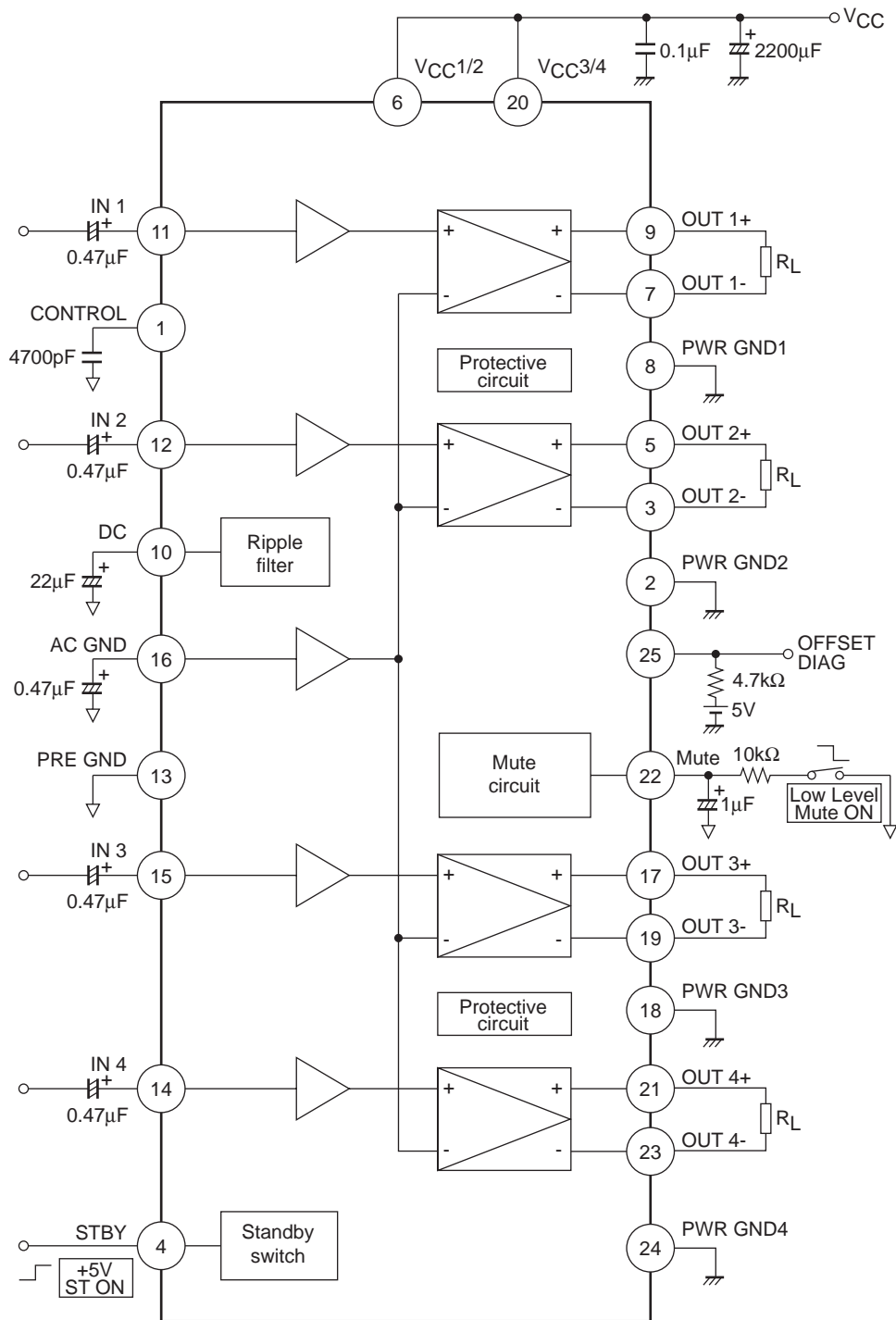

The components and constant values in the test circuit are used for confirmation of characteristics and do not guarantee that the application equipment will be free from malfunction or trouble.

Description of Operation

1. Standby switch function (pin 4)

The pin 4 threshold voltage is set to about 3 VBE.

The amplifier is turned ON at the application voltage of 3.0V or more and OFF at 0.5V or less.

2. Muting function (pin 22)

When pin 22 is set to the ground potential, the LA47202P goes to the muted state. This supports implementation of an audio muting function.

The muting function is turned on when a level of 1V or lower is applied through a 10kΩ resistor, and the function is turned off when this pin is open.

The muting time constant can be set with an external RC circuit.

3. Self diagnostics function (pin 25)

This function detects abnormal IC states, and outputs a signal from pin 25. Applications can prevent damage to speakers and other problems by using a microcontroller to detect the pin 25 signal and control the standby switch accordingly.

(1) Output short-circuit to V_{CC}/ground : Pin 25 becomes LOW.

(2) Load short-circuit : Pin 25 repeats HIGH and LOW states according to the output signal.

(3) Output offset abnormality : Pin 25 goes low if the OUT pin (V_N) voltage becomes lower than the detection level. Problems that can cause an output offset abnormality include input capacitor leakage and half shorts between the input pins and adjacent circuit components.

Note that pin 25 is the NPN open collector output (active low). Keep pin 25 open-connection when not using.

4. CONTROL pin (pin 1)

The protective circuit response speed is adjusted by the pin 1 capacitor.

By adjusting the response speed of the protective circuit, abnormal sound generated when the protective circuit operates at input of the large signal can be prevented.

When the capacitance value increases, abnormal sound is more difficult to be generated, but the response speed of the protective circuit becomes lower. The capacitance value must be limited to maximum 0.01μF. The recommended value is 4700pF.

Check the optimum value for each set.

As this is designed so that the protective circuit is activated when pin 1 has the GND potential, the protective circuit becomes normally active when the capacitor is short-circuited.

5. AC GND pin (pin 16)

Be sure to use the pin 16 capacitor with the capacity the same as that of the input capacitor and connect it to PREGND the same as that of the input capacitor.

6. Sound quality (low frequencies)

The frequency characteristics in low frequency range may be improved by varying the capacitance of input capacitor.

Note that this may cause influence on the shock noise, carry out confirmation with each set before varying the capacitance value.

7. Impulse noise related systems

While the LA47202P does include an impulse noise prevention circuit, we recommend using the muting function together with this circuit.

- When the amplifier is ON, turn ON the muting function simultaneously with power ON. When the output DC potential has stabilized, turn OFF the muting function.

- When turning OFF the amplifier, first turn ON the muting function, then turn OFF power supply.

8. Oscillation stability

Pay due attention on the following points because parasitic oscillation may occur due to effects of the capacity load, board layout, etc.

(1) Capacity load

When the capacitor is to be inserted between each output pin and GND so as to prevent electric mirror noise, select the capacitance of maximum 1200pF. (Conditions : Our recommended board, $R_L = 4\Omega$)

(2) Board layout

- Provide the V_{CC} capacitor of 0.1 μ F in the position nearest to IC.
- PREGND must be independently wired and connected to the GND point that is as stable as possible, such as the minus pin of the 2200 μ F V_{CC} capacitor.

In case of occurrence of parasitic oscillation, any one of following parts may be added as a countermeasure.

Note that the optimum capacitance must be checked for each set in the mounted state.

- Series connection of CR (0.1 μ F and 2.2 Ω) between BTL outputs
- Series connection of CR (0.1 μ F and 2.2 Ω) between each output pin and GND.

Package Dimensions

unit : mm (typ)

3236A

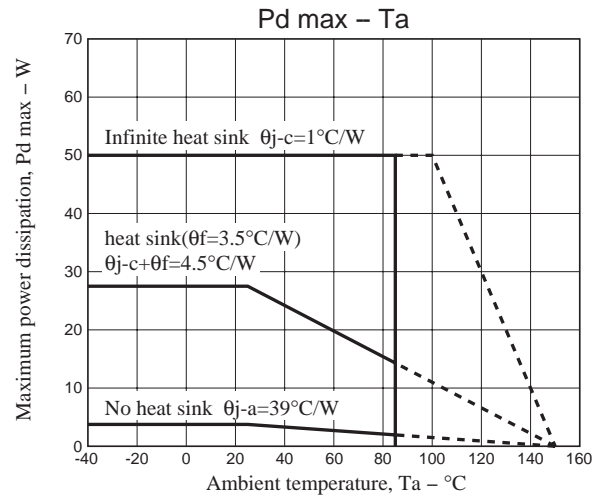
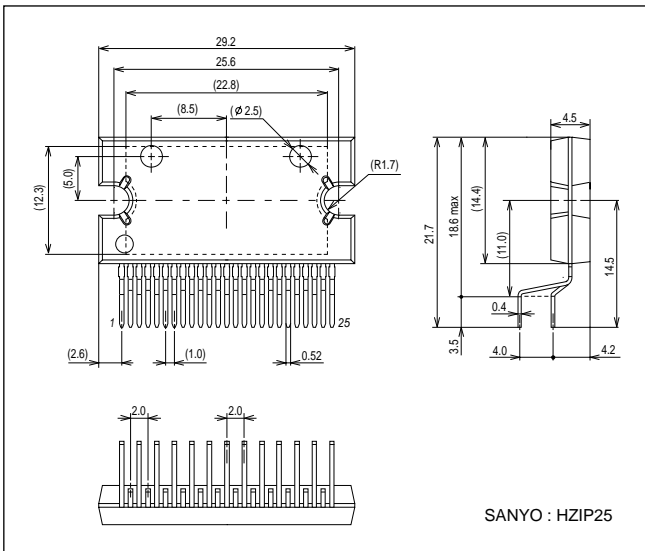

LA47202P

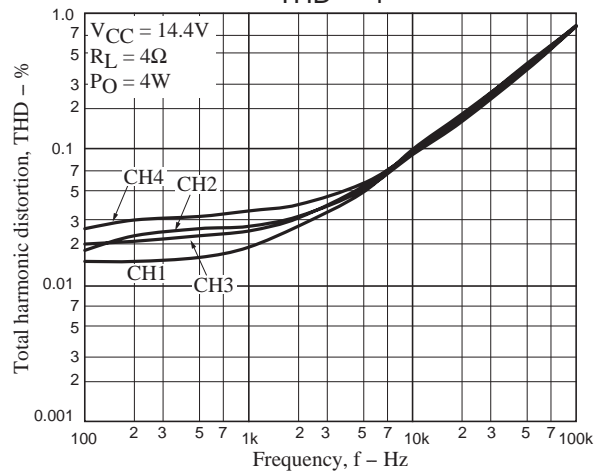
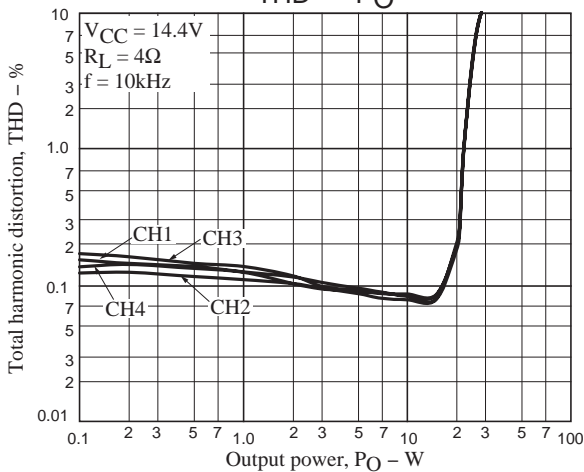
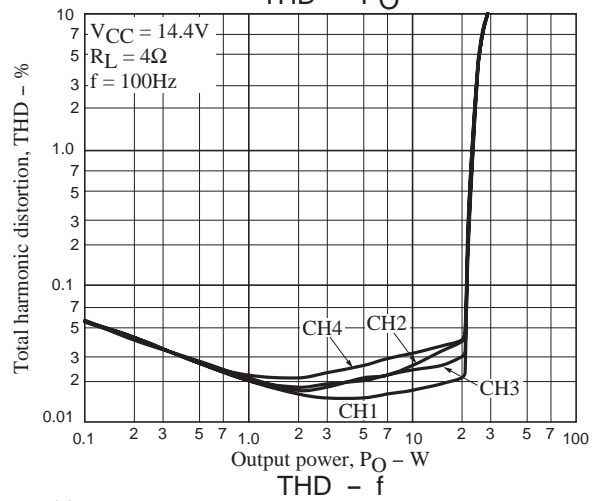
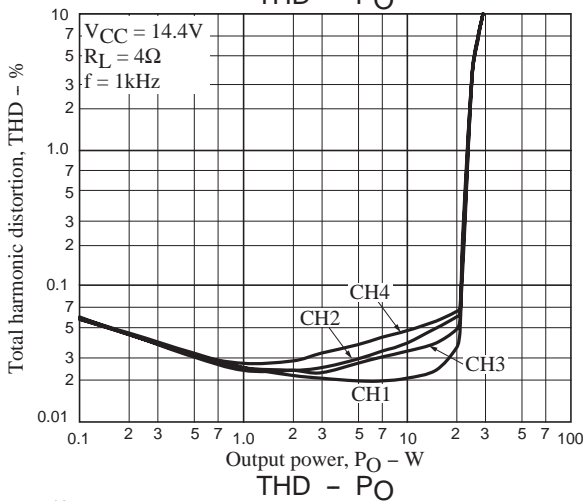
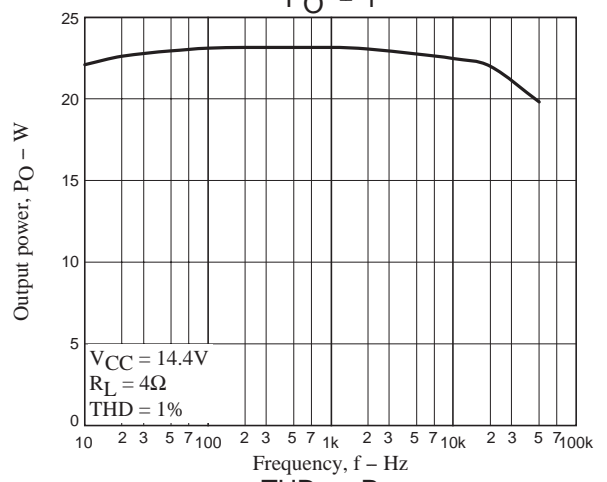
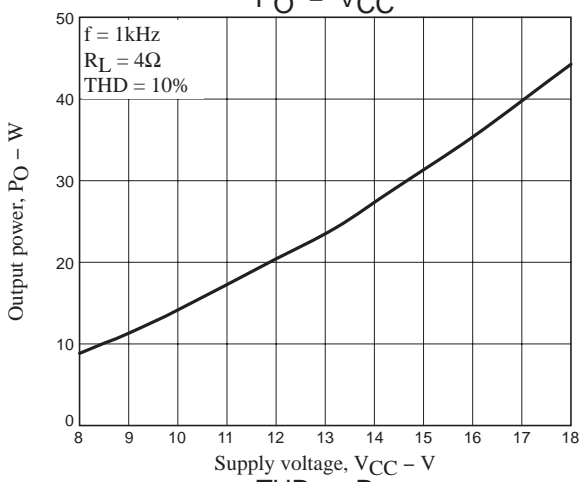
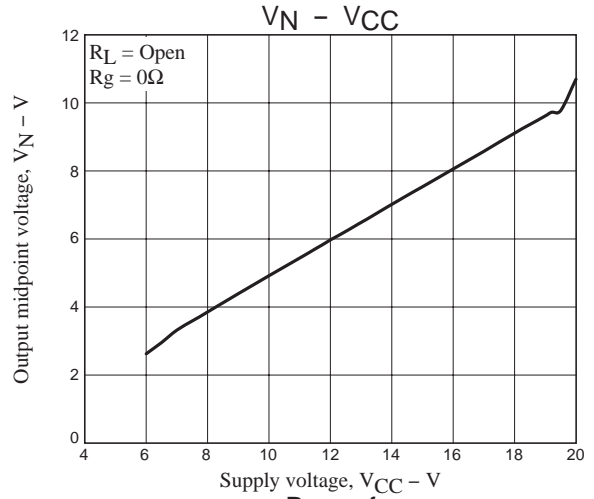
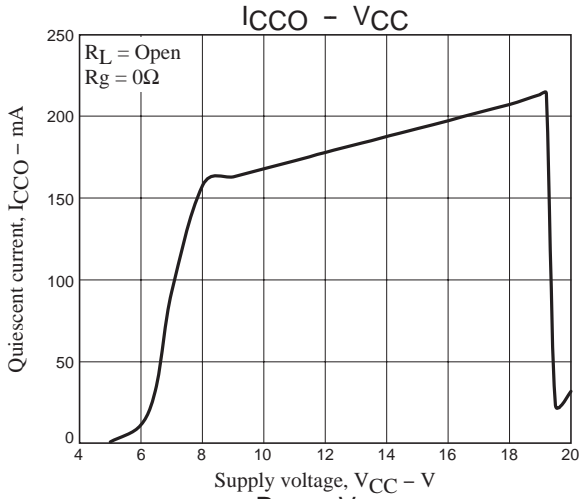

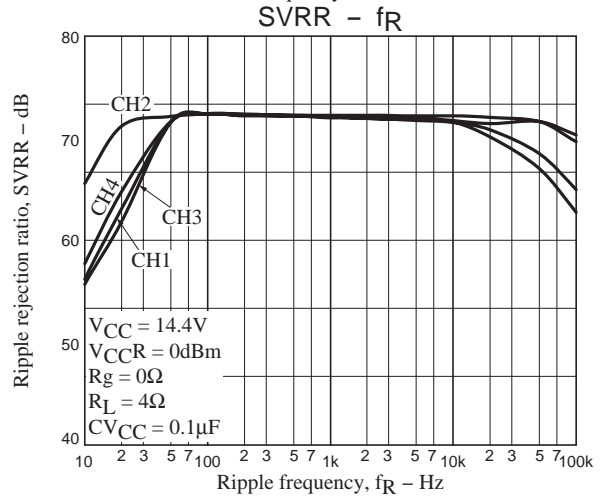
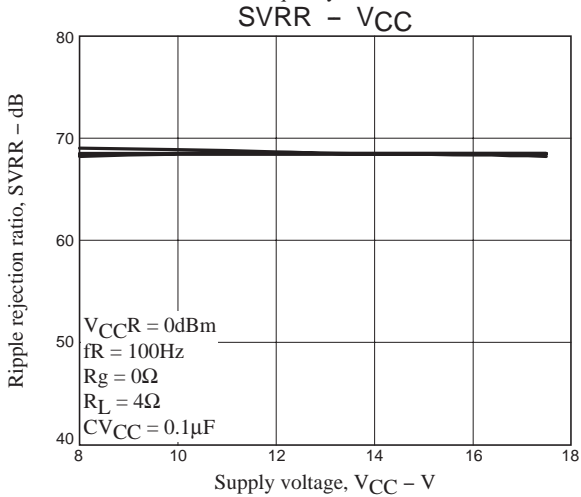
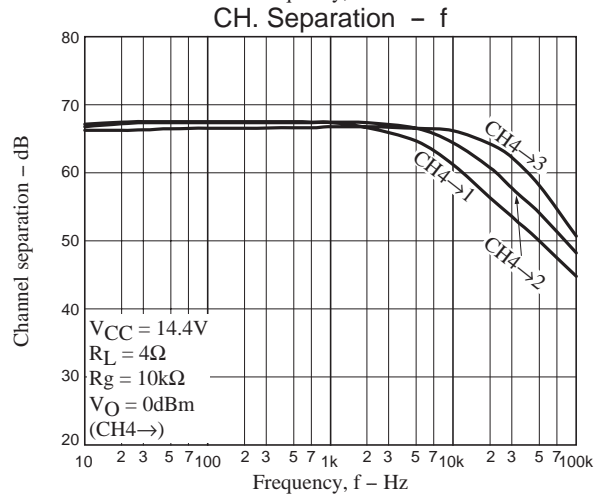
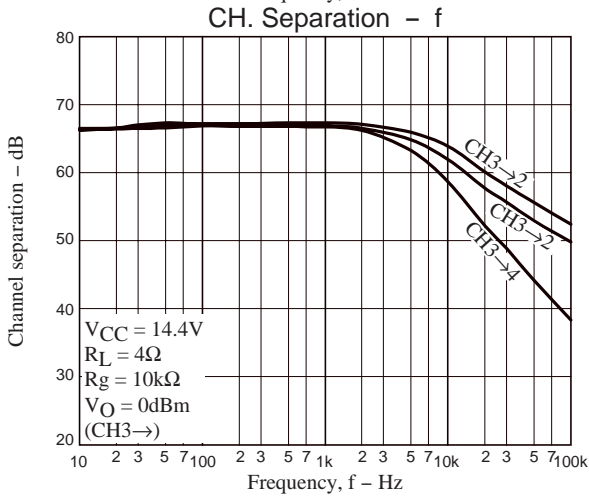
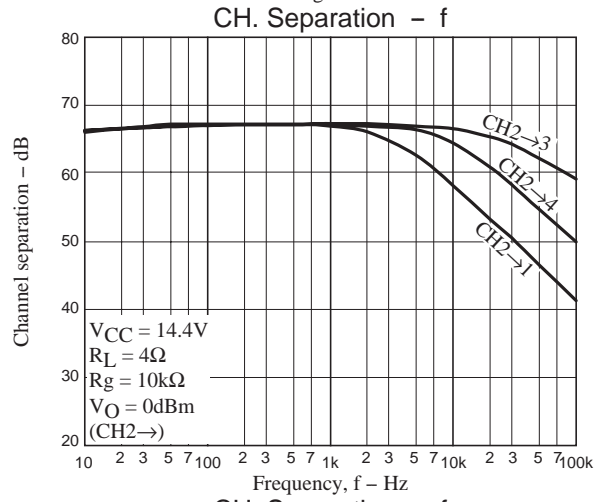
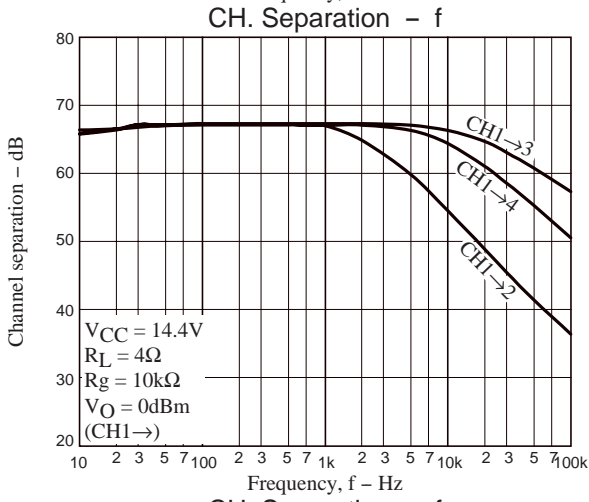
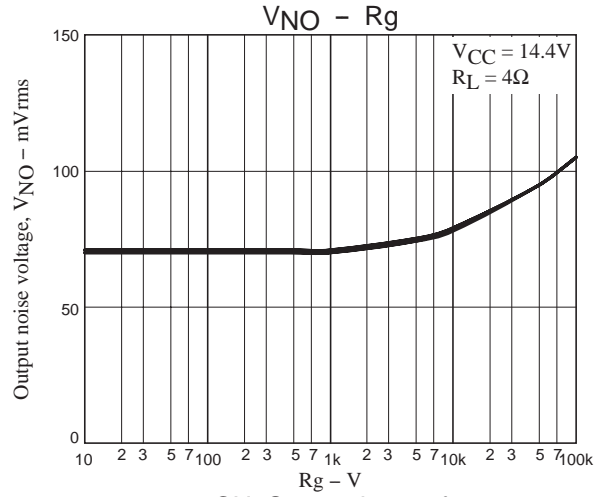
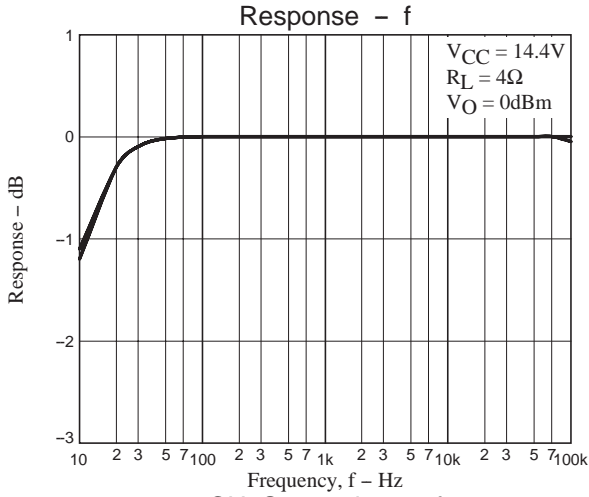

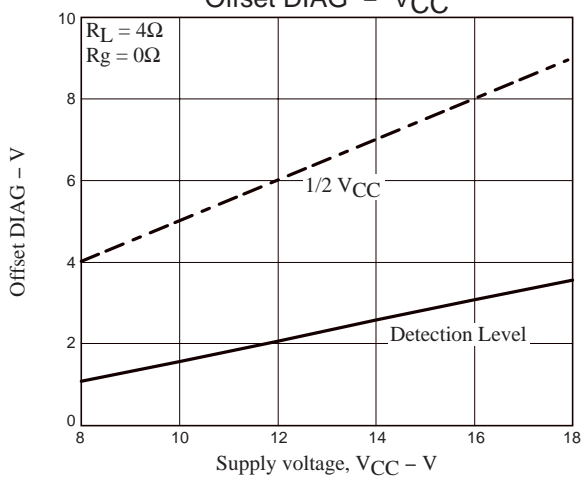
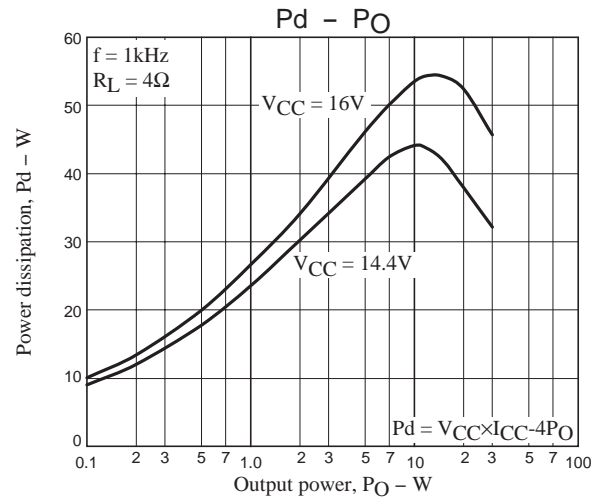
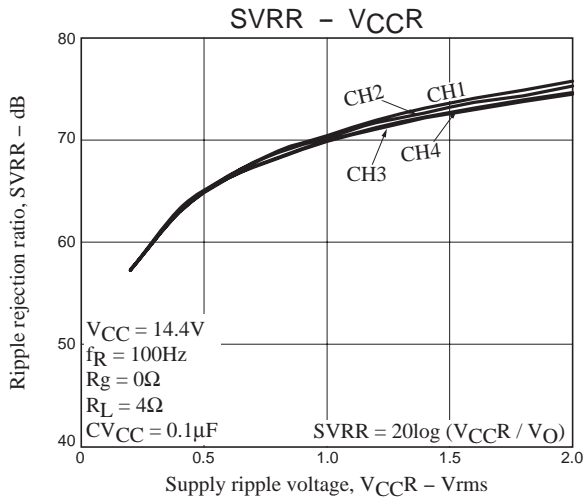

- Specifications of any and all SANYO Semiconductor products described or contained herein stipulate the performance, characteristics, and functions of the described products in the independent state, and are not guarantees of the performance, characteristics, and functions of the described products as mounted in the customer's products or equipment. To verify symptoms and states that cannot be evaluated in an independent device, the customer should always evaluate and test devices mounted in the customer's products or equipment.
- SANYO Semiconductor Co., Ltd. strives to supply high-quality high-reliability products. However, any and all semiconductor products fail with some probability. It is possible that these probabilistic failures could give rise to accidents or events that could endanger human lives, that could give rise to smoke or fire, or that could cause damage to other property. When designing equipment, adopt safety measures so that these kinds of accidents or events cannot occur. Such measures include but are not limited to protective circuits and error prevention circuits for safe design, redundant design, and structural design.
- In the event that any or all SANYO Semiconductor products (including technical data, services) described or contained herein are controlled under any of applicable local export control laws and regulations, such products must not be exported without obtaining the export license from the authorities concerned in accordance with the above law.
- No part of this publication may be reproduced or transmitted in any form or by any means, electronic or mechanical, including photocopying and recording, or any information storage or retrieval system, or otherwise, without the prior written permission of SANYO Semiconductor Co., Ltd.
- Any and all information described or contained herein are subject to change without notice due to product/technology improvement, etc. When designing equipment, refer to the "Delivery Specification" for the SANYO Semiconductor product that you intend to use.
- Information (including circuit diagrams and circuit parameters) herein is for example only; it is not guaranteed for volume production. SANYO Semiconductor believes information herein is accurate and reliable, but no guarantees are made or implied regarding its use or any infringements of intellectual property rights or other rights of third parties.

This catalog provides information as of December, 2006. Specifications and information herein are subject to change without notice.