

Dual Channel USB3.0 Redriver/Equalizer

 Check for Samples: [SN65LVPE502CP](#)

FEATURES

- Single Lane USB 3.0 Equalizer/Redriver
- Selectable Equalization, De-Emphasis and Output Swing Control
- Integrated Termination
- Hot-Plug Capable
- Low Active Power (U0 state)
 - 315 mW (TYP), $V_{CC} = 3.3V$
- USB 3.0 Low Power Support
 - 7 mW (TYP) When no Connection Detected
 - 70 mW (TYP) When Link in U2/U3 Mode
- Excellent Jitter and Loss Compensation Capability:
 - >40" of Total 4 mil Stripline on FR4
- Small Foot Print – 24 Pin (4mm x 4mm) QFN Package

- High Protection Against ESD Transient
 - HBM: 5,000 V
 - CDM: 1,500 V
 - MM: 200 V

APPLICATIONS

- Notebooks, Desktops, Docking Stations, Active Cable, Backplane and Active Cable

DESCRIPTION

The SN65LVPE502CP is a dual channel, single lane USB 3.0 redriver and signal conditioner supporting data rates of 5.0Gbps. The device complies with USB 3.0 spec revision 1.0, supporting electrical idle condition and low frequency periodic signals (LFPS) for USB 3.0 power management modes.

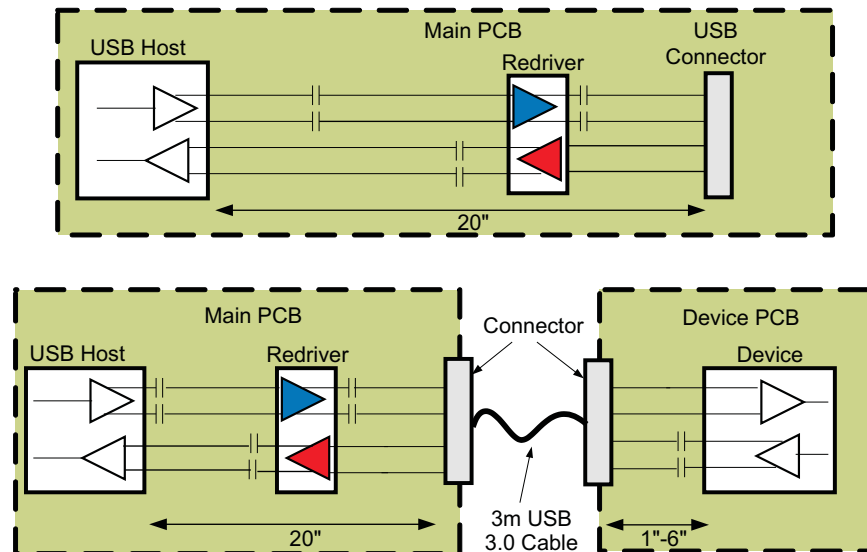

Figure 1. Typical Application



Please be aware that an important notice concerning availability, standard warranty, and use in critical applications of Texas Instruments semiconductor products and disclaimers thereto appears at the end of this data sheet.



These devices have limited built-in ESD protection. The leads should be shorted together or the device placed in conductive foam during storage or handling to prevent electrostatic damage to the MOS gates.

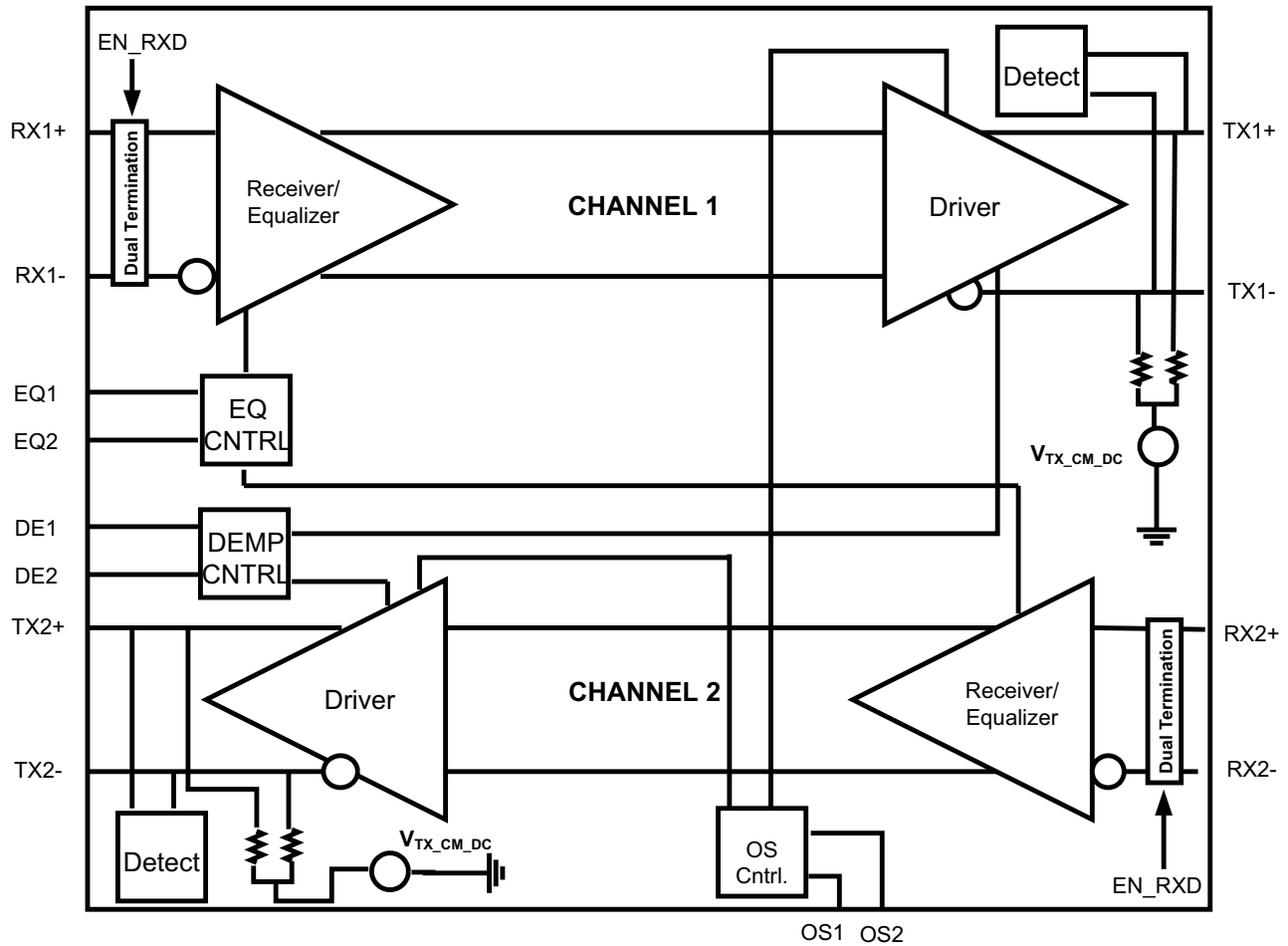

Figure 2. Data Flow Block Diagram

ORDERING INFORMATION⁽¹⁾

PART NUMBER	PART MARKING	PACKAGE
SN65LVPE502CPRGER	502CP	24-pin RGE Reel (Large)
SN65LVPE502CPRGET	502CP	24-pin RGE Reel (Small)

(1) For the most current package and ordering information, see the Package Option Addendum at the end of this document, or see the TI web site at www.ti.com.

ABSOLUTE MAXIMUM RATINGS⁽¹⁾

over operating free-air temperature range (unless otherwise noted)

		VALUE		UNIT
		MIN	MAX	
Supply voltage range ⁽²⁾	V _{CC}	–0.5	4	V
Voltage range	Differential I/O	–0.5	4	V
	Control I/O	–0.5	V _{CC} + 0.5	V
Electrostatic discharge	Human body model ⁽³⁾	±5000		V
	Charged-device model ⁽⁴⁾	±1500		V
	Machine model ⁽⁵⁾	±200		V
Continuous power dissipation		See Thermal Table		

- (1) Stresses beyond those listed under absolute maximum ratings may cause permanent damage to the device. These are stress ratings only and functional operation of the device at these or any conditions beyond those indicated under recommended operating conditions is not implied. Exposure to absolute-maximum-rated conditions for extended periods may affect device reliability.
- (2) All voltage values, except differential voltages, are with respect to network ground terminal.
- (3) Tested in accordance with JEDEC Standard 22, Test Method A114-B
- (4) Tested in accordance with JEDEC Standard 22, Test Method C101-A
- (5) Tested in accordance with JEDEC Standard 22, Test Method A115-A

THERMAL INFORMATION

THERMAL METRIC ⁽¹⁾		SN65LVPE502CP	UNITS
		RGE PACKAGE	
		24 PINS	
θ_{JA}	Junction-to-ambient thermal resistance	46	°C/W
θ_{JcTop}	Junction-to-case (top) thermal resistance	42	
θ_{JB}	Junction-to-board thermal resistance	13	
θ_{JcBot}	Junction-to-case (bottom) thermal resistance	4	

- (1) For more information about traditional and new thermal metrics, see the *IC Package Thermal Metrics* application report, [SPRA953](#).

THERMAL CHARACTERISTICS

over recommended operating free-air temperature range (unless otherwise noted)

PARAMETER		TEST CONDITIONS	MIN	TYP	MAX ⁽¹⁾	UNIT
P _D	Device power dissipation	RSVD, EN_RXD, EQ cntrl pins = NC, K28.5 pattern at 5 Gbps, V _{ID} = 1000mV _{p-p}		330	450	mW
P _{Sip}	Device power dissipation in sleep mode	EN_RXD= GND		0.3	1	mW

- (1) The maximum rating is simulated under 3.6V VCC.

Device Power

The SN65LVPE502CP is designed to operate from a single 3.3V supply.

RECOMMENDED OPERATING CONDITIONS

PARAMETER		CONDITIONS	MIN	TYP	MAX	UNITS
V _{CC}	Supply voltage		3	3.3	3.6	V
C _{COUPLING}	AC Coupling capacitor		75		200	nF
	Operating free-air temperature		0		85	°C
DEVICE PARAMETERS						
I _{CC}	Supply current	EN_RXD, RSVD, EQ cntrl = NC, K28.5 pattern at 5 Gbps, VID = 1000mVp-p	100	120		mA
I _{CC} _{Rx.Detect}		In Rx.Detect mode	2	5		
I _{CC} _{sleep}		EN_RXD = GND	0.01	0.1		
I _{CC} _{U2-U3}		Link in USB low power state	21			
	Maximum data rate			5		Gbps
t _{ENB}	Device enable time	Sleep mode exit time EN_RXD L → H With Rx termination present			100	μs
t _{DIS}	Device disable time	Sleep mode entry time EN_RXD H → L			2	μs
T _{RX.DETECT}	Rx.Detect start event	Power-up time			100	μs
CONTROL LOGIC						
V _{IH}	High level input voltage		1.4	V _{CC}		V
V _{IL}	Low level input voltage		-0.3		0.5	V
V _{HYS}	Input hysteresis			150		mV
I _{IH}	High level input current	OSx, EQx, DEx = V _{CC}			30	μA
		EN_RXD = V _{CC}			1	
		RSVD = V _{CC}			30	
I _{IL}	Low level input current	OSx, EQx, DEx = GND	-30			μA
		EN_RXD = GND	-30			
		RSVD = GND	-1			

ELECTRICAL CHARACTERISTICS

over recommended operating conditions (unless otherwise noted)

PARAMETER		CONDITIONS	MIN	TYP	MAX	UNITS
RECEIVER AC/DC						
V _{in_diff_p-p}	RX1, RX2 input voltage swing	AC coupled differential RX peak to peak signal	100		1200	mVp-p
V _{CM_RX}	RX1, RX2 common mode voltage			3.3		V
V _{in_COM_P}	RX1, RX2 AC peak common mode voltage	Measured at Rx pins with termination enabled			150	mVP
Z _{DC_RX}	DC common mode impedance		18	26	30	Ω
Z _{diff_RX}	DC differential input impedance		72	80	120	Ω
Z _{RX_High_IMP+}	DC Input high impedance	Device in sleep mode Rx termination not powered measured with respect to GND over 500mV max	50	85		kΩ
V _{RX-LFPS-DETPP}	Low voltage periodic signaling (LFPS) detect threshold	Measured at receiver pin, below minimum output is squelched, above max input signal is passed to output	100		300	mVpp
R _{L_RX-DIFF}	Differential return loss	50 MHz – 1.25 GHz	10	11		dB
		1.25 GHz – 2.5 GHz	6	7		
R _{L_RX-CM}	Common mode return loss	50 MHz– 2.5 GHz	11	13		dB
TRANSMITTER AC/DC						
V _{TxDIFF_TB_P-P}	Differential peak-to-peak output voltage (VID = 800, 1200 mVpp, 5Gbps)	R _L = 100 Ω ±1%, DEX, OSx = NC, Transition Bit	800	1042	1200	mV
		R _L = 100 Ω ±1%, DEX = NC, OSx = GND Transition Bit		908		
		R _L = 100 Ω ±1%, DEX = NC, OSx = VCC Transition Bit		1127		
V _{TxDIFF_NTb_P-P}	Differential peak-to-peak output voltage (VID = 800, 1200 mVpp, 5Gbps)	R _L = 100 Ω ±1%, DEX=NC, OSx = 0,1,NC Non-Transition Bit		1042		mV
		R _L = 100 Ω ±1%, DEX=0 OSx = 0,1,NC Non-Transition Bit		661		
		R _L = 100 Ω ±1%, DEX=1 OSx = 0,1,NC Non-Transition Bit		507		
DE	De-emphasis level OS1,2 = NC (for OS1, 2 = 1 and 0 see Table 2)	DE1/DE2 = NC		0		dB
		DE1/DE2 = 0	-3.0	-3.5	-4.0	
		DE1/DE2 = 1		-6.0		
T _{DE}	De-emphasis width			0.85		UI
Z _{diff_TX}	DC differential impedance		72	90	120	Ω
Z _{CM_TX}	DC common mode impedance	Measured w.r.t to AC ground over 0-500mV	18	23	30	Ω
R _{L_diff_TX}	Differential return loss	f = 50 MHz – 1.25 GHz	9	10		dB
		f = 1.25 GHz – 2.5 GHz	6	7		
R _{L_CM_TX}	Common mode return loss	f = 50 MHz – 2.5 GHz	11	12		dB
I _{TX_SC}	TX short circuit current	TX± shorted to GND			60	mA
V _{TX_CM_DC}	Transmitter DC common-mode voltage		2.0	2.6	3.0	V
V _{TX_CM_AC_Active}	TX AC common mode voltage active			30	100	mVpp
V _{TX_idle_diff-AC-pp}	Electrical idle differential peak to peak output voltage	HPF to remove DC	0		10	mVpp
V _{TX_CM_DeltaU1-U0}	Absolute delta of DC CM voltage during active and idle states			35	200	mV
V _{TX_idle_diff-DC}	DC Electrical idle differential output voltage	Voltage must be low pass filtered to remove any AC component	0		10	mV
V _{detect}	Voltage change to allow receiver detect	Positive voltage to sense receiver termination			600	mV
t _R , t _F	Output rise/fall time	20%–80% of differential voltage measured 1" from the output pin	30	65		ps
t _{RF_MM}	Output rise/fall time mismatch	20%–80% of differential voltage measured 1" from the output pin		1.5	20	ps
T _{diff_LH+} , T _{diff_HL}	Differential propagation delay	De-Emphasis = -3.5 dB (CH 0 and CH 1). Propagation delay between 50% level at input and output		305	370	ps
t _{idleEntry} , t _{idleExit}	Idle entry and exit times	See Figure 4		4	6	ns
C _{TX}	Tx input capacitance to GND	At 2.5 GHz		1.25		pF

ELECTRICAL CHARACTERISTICS (continued)

over recommended operating conditions (unless otherwise noted)

PARAMETER	CONDITIONS	MIN	TYP	MAX	UNITS
EQUALIZATION					
$T_{TX-EYE}^{(1)(2)}$ Total jitter (Tj) at point A	Device setting: OS1 = L, DE1 = -6 dB, EQ1 = 7 dB		0.23	0.5	UI ⁽³⁾ p-p
$DJ_{TX}^{(2)}$ Deterministic jitter (Dj)			0.14	0.3	
$RJ_{TX}^{(2)(4)}$ Random jitter (Rj)			0.08	0.2	
$T_{TX-EYE}^{(1)(2)}$ Total jitter (Tj) at point B	Device setting: OS2 = H, DE2 = -6 dB, EQ2 = 7dB		0.15	0.5	UI ⁽³⁾ p-p
$DJ_{TX}^{(2)}$ Deterministic jitter (Dj)			0.07	0.3	
$RJ_{TX}^{(2)(4)}$ Random jitter (Rj)			0.08	0.2	

- (1) Includes RJ at 10^{-12} BER
- (2) Deterministic jitter measured with K28.5 pattern, Random jitter measured with K28.5 pattern at the ends of reference channel in [Figure 6](#), VID=1000mVpp, 5Gbps, -3.5dB DE from source
- (3) UI = 200ps
- (4) Rj calculated as 14.069 times the RMS random jitter for 10^{-12} BER

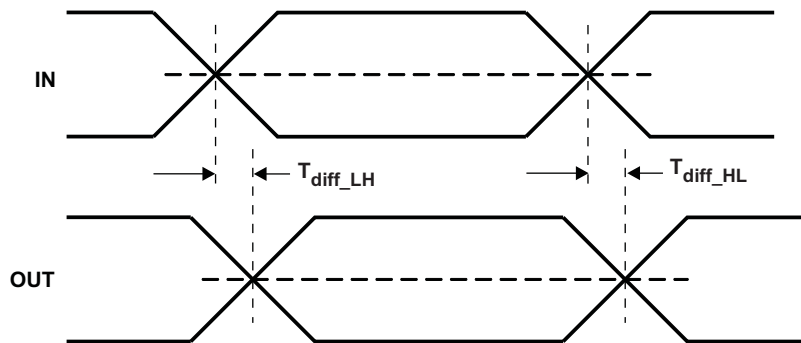

Figure 3. Propagation Delay

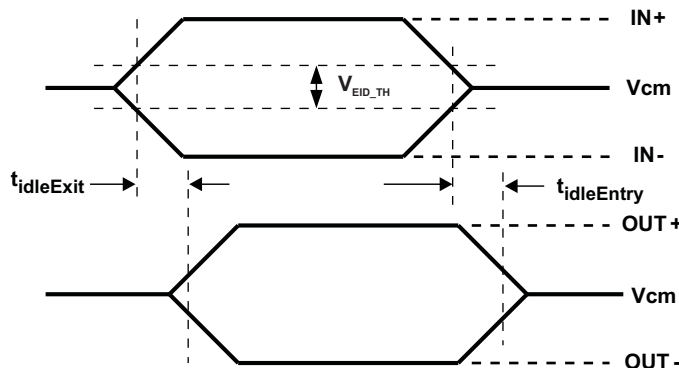

Figure 4. Electrical Idle Mode Exit and Entry Delay

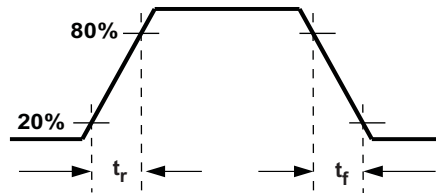

Figure 5. Output Rise and Fall Times

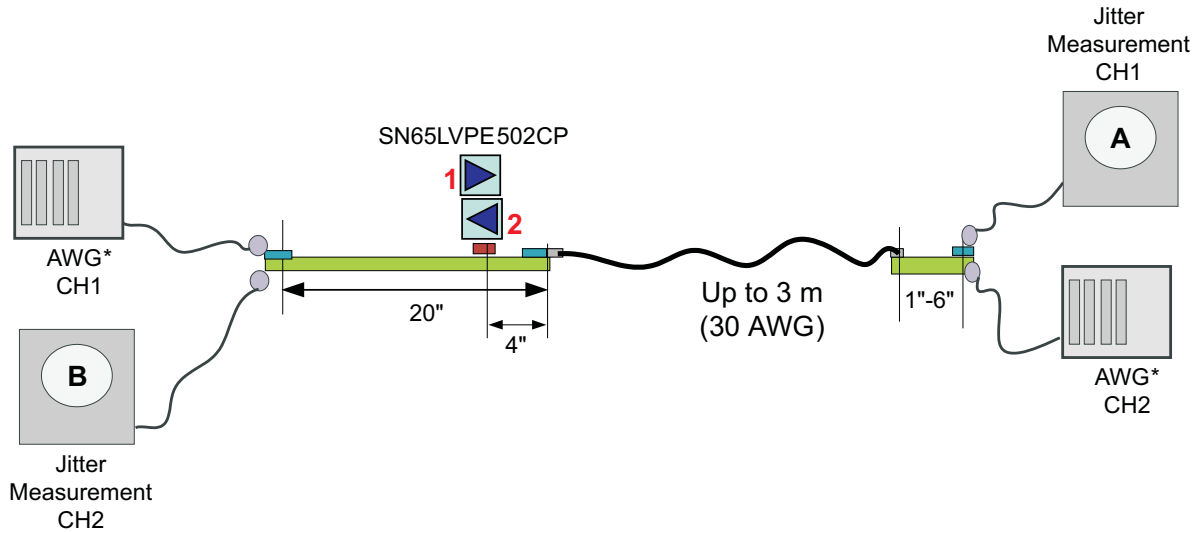

Figure 6. Jitter Measurement Setup

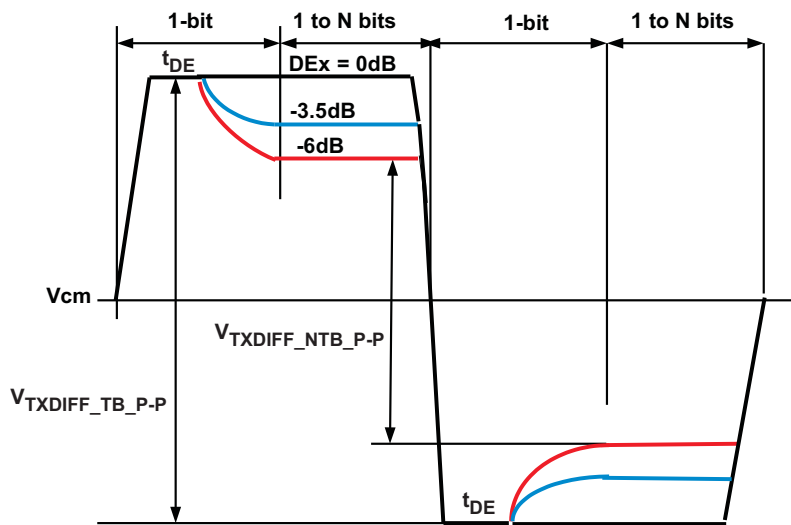
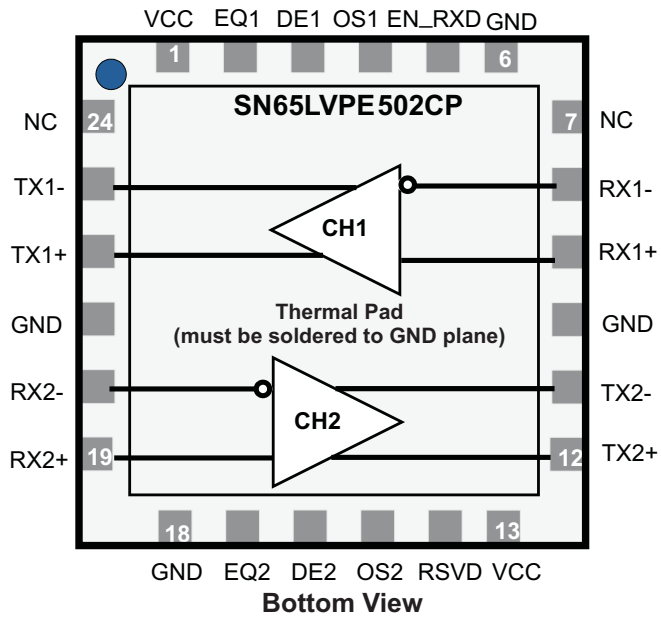
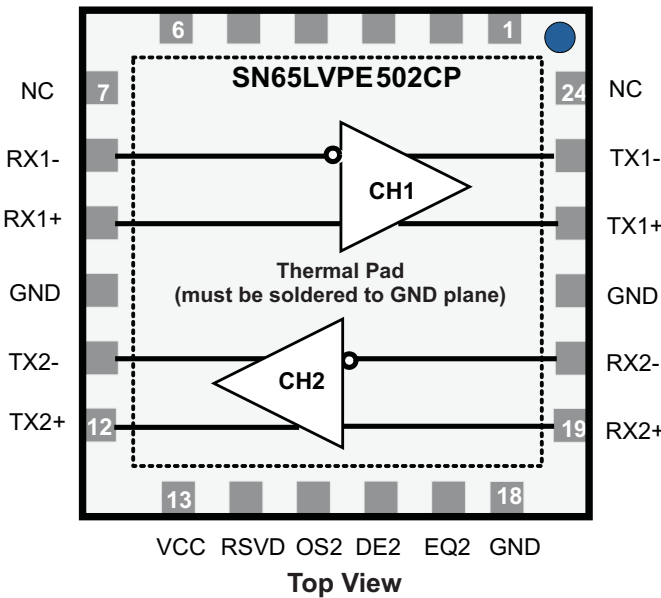

Figure 7. Output De-Emphasis Levels OSx = NC

DEVICE INFORMATION



GND EN_RXD OS1 DE1 EQ1 VCC



VCC RSVD OS2 DE2 EQ2 GND

Figure 8. Flow-Through Pin-Out

Table 1. Pin Functions

PIN		I/O Type	Description
Number	Name		
HIGH SPEED DIFFERENTIAL I/O PINS			
8	RX1-	I, CML	Non-inverting and inverting CML differential input for CH 1 and CH 2. These pins are tied to an internal voltage bias by dual termination resistor circuit.
9	RX1+	I, CML	
20	RX2-	I, CML	
19	RX2+	I, CML	

Table 1. Pin Functions (continued)

PIN		I/O Type	Description
Number	Name		
23	TX1-	O, VML	Non-inverting and inverting VML differential output for CH 1 and CH 2. These pins are internally tied to voltage bias by termination resistors.
22	TX1+	O, VML	
11	TX2-	O, VML	
12	TX2+	O, VML	
DEVICE CONTROL PIN			
5	EN_RXD	I, LVCMOS	Sets device operation modes per Table 2 . Internally pulled to VCC
14	RSVD	I, LVCMOS	RSVD, internally pulled to GND. Can be left as No-connect.
7, 24	NC	No-connect	Pads are not internally connected
EQ CONTROL PINS⁽¹⁾			
3, 16	DE1, DE2	I, LVCMOS	Selects de-emphasis settings for CH 1 and CH 2 per Table 2 . Internally tied to Vcc/2
2, 17	EQ1, EQ2	I, LVCMOS	Selects equalization settings for CH 1 and CH 2 per Table 2 . Internally tied to Vcc/2
4, 15	OS1, OS2	I, LVCMOS	Selects output amplitude for CH 1 and CH 2 per Table 2 . Internally tied to Vcc/2
POWER PINS			
1, 13	VCC	Power	Positive supply should be 3.3V ± 10%
6, 10, 18, 21	GND	Power	Supply ground

(1) Internally biased to Vcc/2 with >200kΩ pull-up/pull-down. When pins are left as NC board leakage at this pin pad must be < 1 μA otherwise drive to Vcc/2 to assert mid-level state

Table 2. Signal Control Pin Setting

OUTPUT SWING AND EQ CONTROL (at 2.5 GHz)			
OS _x ⁽¹⁾	TRANSITION BIT AMPLITUDE (TYP mVpp)	EQ _x ⁽¹⁾	EQUALIZATION (dB)
NC (default)	1042	NC (default)	0
0	908	0	7
1	1127	1	15
OUTPUT DE CONTROL (at 2.5 GHz)			
DE _x ⁽¹⁾	OS _x ⁽¹⁾ = NC	OS _x ⁽¹⁾ = 0	OS _x ⁽¹⁾ = 1
NC (default)	0 dB	0 dB	0 dB
0	-3.5 dB	-2.2 dB	-4.4 dB
1	-6.0 dB	-5.2 dB	-6.0 dB
CONTROL PINS SETTINGS			
EN_RXD	DEVICE FUNCTION		
1 (default)	Normal Operation		
0	Sleep Mode		

(1) Where x = Channel 1 or Channel 2

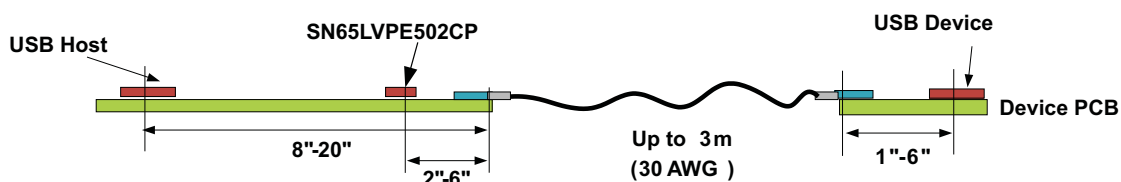

NOTE: For more detailed placement example of redriver see typical eye diagrams and jitter plots at end of data sheet.

Figure 9. Redriver Placement Example

DETAILED DESCRIPTION

Programmable EQ, De-Emphasis and Amplitude Swing

The SN65LVPE502CP is designed to minimize signal degradation effects such as crosstalk and inter-symbol interference (ISI) that limits the interconnect distance between two devices. The input stage of each channel offers selectable equalization settings that can be programmed to match loss in the channel. The differential outputs provide selectable de-emphasis to compensate for the anticipated distortion USB 3.0 signal will experience. Level of de-emphasis will depend on the length of interconnect and its characteristics. The SN65LVPE502CP provides a unique way to tailor output de-emphasis on a per channel basis with use of DE and OS pins. All Rx and Tx equalization settings supported by the device are programmed by six 3-state pins as shown in [Table 2](#).

Low Power Modes

Device supports three low power modes as described below

1. Sleep Mode

Initiated anytime EN_RXD undergoes a high to low transition and stays low or when device powers up with EN_RXD set low. In sleep mode both input and output terminations are held at HiZ and device ceases operation to conserve power. Sleep mode max power consumption is 1mW, entry time is 2 μ s, device exits sleep mode to Rx.Detect mode after EN_RXD is driven to Vcc, exit time is 100 μ s max.

2. RX Detect Mode--When no remote device is connected

Anytime LVPE502CP detects a break in link (i.e. when upstream device is disconnected) or after power-up fails to find a remote device, LVPE502CP goes to Rx Detect mode and conserves power by shutting down majority of its internal circuitry. In this mode input termination for both channels are driven to Hi-Z. In Rx Detect mode device power is <10mW (TYP) or less than 5% of its normal operating power. This feature is very useful in saving system power in mobile applications like notebook PC where battery life is critical.

Anytime an upstream device gets reconnected the redriver automatically senses the connection and goes to normal operating mode. This operation requires no setting to the device.

3. U2/U3 Mode

With the help of internal timers the device tracks when link enters USB 3.0 low power modes U2 and U3; in these modes link is in electrical idle state. LVPE502CP will selectively turn-off internal circuitry to save on power. Typical power saving is about 75% lower than normal operating mode. The device will automatically revert to active mode when signal activity (LFPS) is detected.

Receiver Detection

At Power Up or Reset

After power-up or anytime EN_RXD is toggled, RX.Detect cycle is performed by first setting Rx termination for each channel to Hi-Z, device then starts sensing for receiver termination that may be attached at the other end of each TX.

If receiver is detected on both channel

- The TX and RX terminations are switched to Z_{DIFF_TX} , Z_{DIFF_RX} respectively.

If no receiver is detected on one or both channels

- The transmitter is pulled to Hi-Z
- The channel is put in low power mode
- Device attempts to detect Rx termination in 12 ms (TYP) interval until termination is found or device is put in sleep mode

During U2/U3 Link State

Rx detection is also performed periodically when link is in U2/U3 states. However in these states during Rx detection, input termination is not automatically disabled before performing Rx.Detect. If termination is found device goes back to its low power state if termination is not found then device disables its input termination and then jumps to power-up RX.Detect state.

Electrical Idle Support

Electrical idle support is needed for low frequency periodic signaling (LFPS) used in USB 3.0 side band communication. A link is in an electrical idle state when the TX± voltage is held at a steady constant value like the common mode voltage. LVPE502CP detects an electrical idle state when RX± voltage at the device pin falls below VRX_LFPS_DIFFp-p min. After detection of an idle state in a given channel the device asserts electrical idle state in its corresponding TX. When RX± voltage exceeds VRX_LFPS_DIFFp-p max normal operation is restored and output start passing input signal. Electrical idle exit and entry time is speccified at < 6ns.

TYPICAL EYE DIAGRAM AND PERFORMANCE CURVES

Measurement equipment details:

- Generator (source) LeCroy PERT3,
- Signal: 5Gbps, 1000mVp-p, 3.5 dB De-Emphasis
- Tj and Dj measurements based on CP0 (USB 3 compliance pattern) which is D0.0 or logical idle with SKP sequences removed
- Rj measurements based on CP1 or D10.2 symbol containing alternating 0s and 1s at Nyquist frequency
- Oscilloscope (Sink) LeCroy 25GHz Real Time Oscilloscope
- LeCroy QualiPHY software used to measure jitter and collect compliance eye diagrams

Device Operating Conditions: VCC = 3.3 V, Temp = 25°C, EQx/DEx/OSx set to their default value when not mentioned

PLOT #1 FIXED OUTPUT TRACE +3m USB 3 CABLE WITH VARIABLE INPUT TRACE

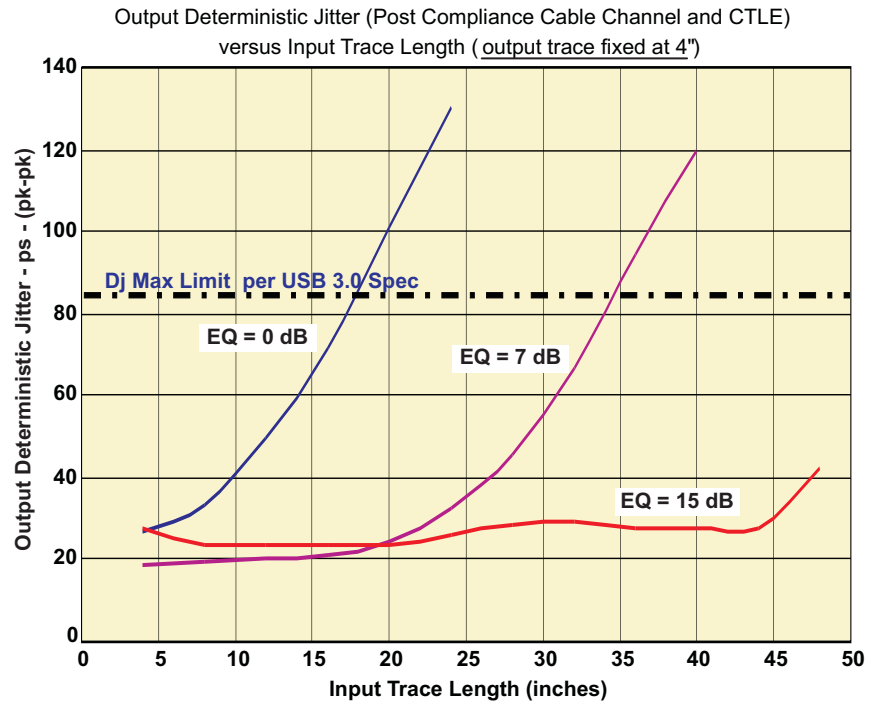
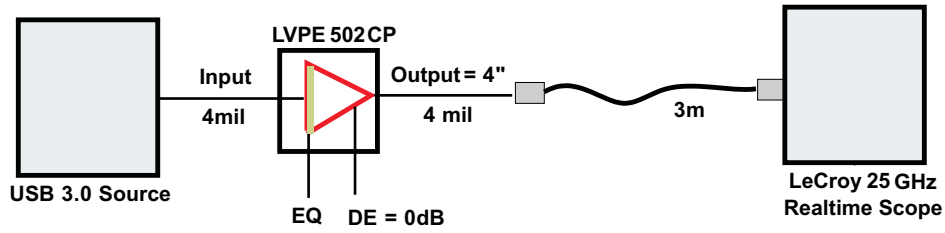

PLOT #2 FIXED INPUT TRACE WITH VARIABLE OUTPUT TRACE and +3m USB 3.0 CABLE

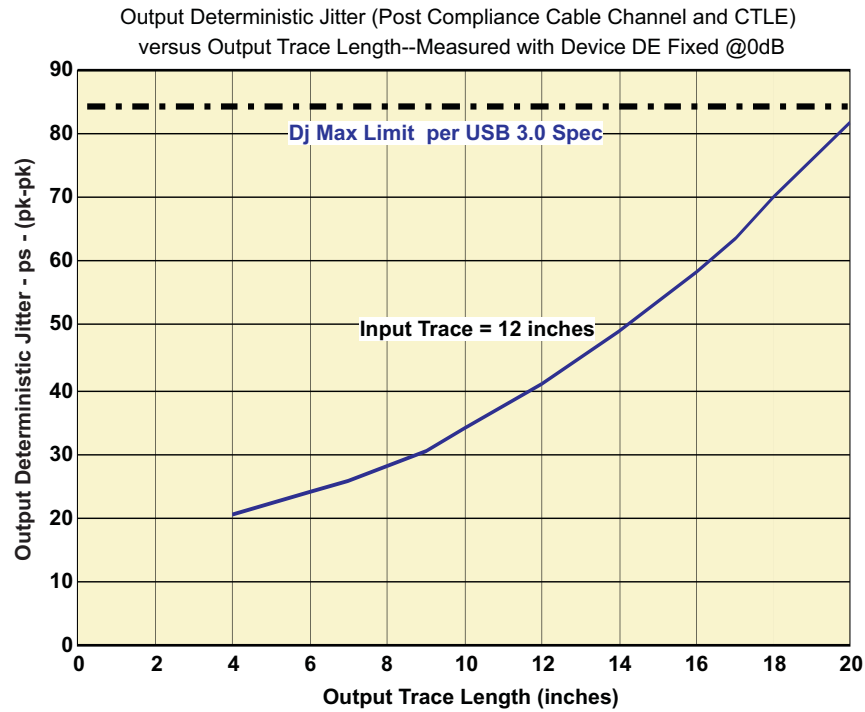
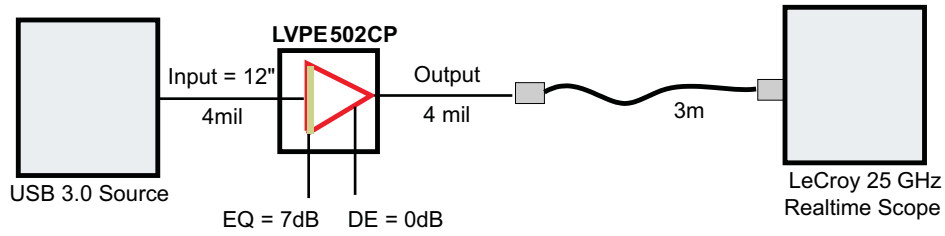

PLOT #3 FIXED INPUT TRACE WITH VARIABLE OUTPUT TRACE and (No Cable)

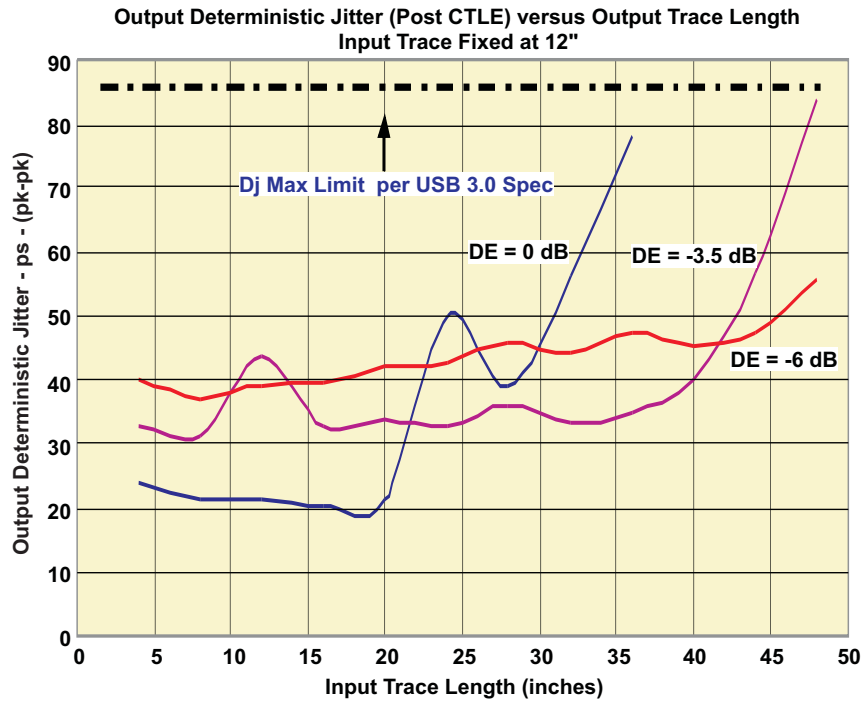
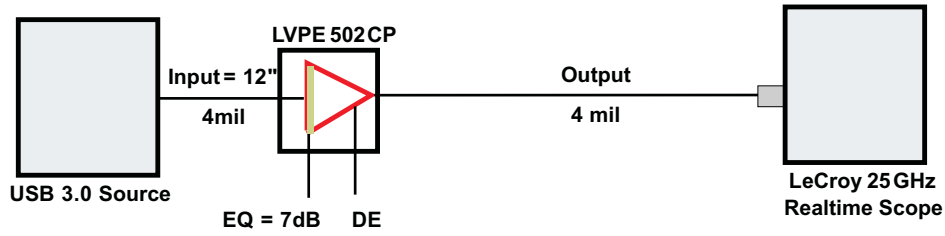

USB 3.0 MASK EYE DIAGRAM TEST

CASE I FIXED OUTPUT AND VARIABLE INPUT TRACE

DE= 0dB, EQ = 0dB, Input = 4", Output = 4" + 3m Cable

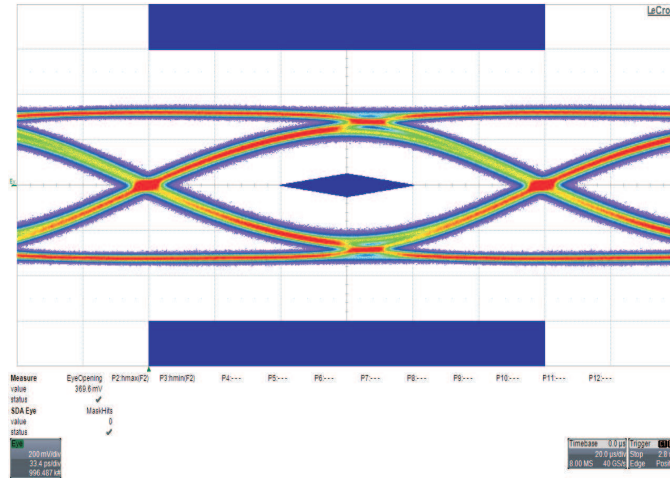

DE= 0dB, EQ = 0dB, Input = 8", Output = 4" + 3m Cable

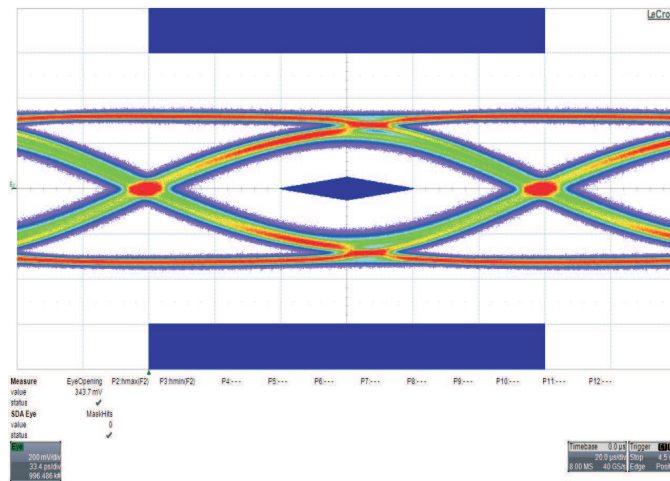

DE= 0dB, EQ = 0dB, Input = 12", Output = 4" + 3m Cable

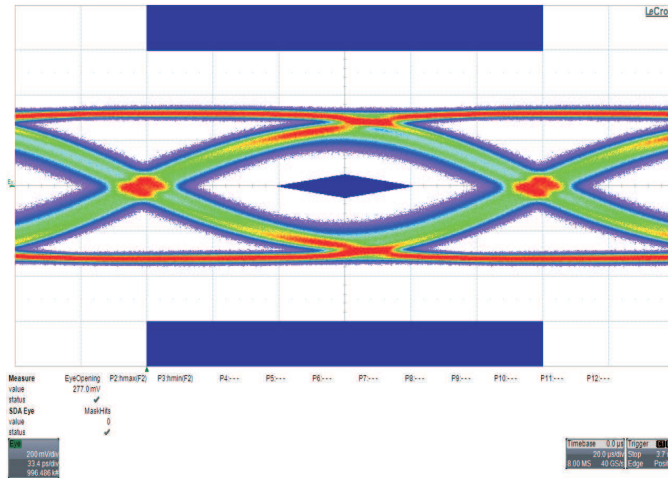

DE= 0dB, EQ = 0dB, Input = 16", Output = 4" + 3m Cable

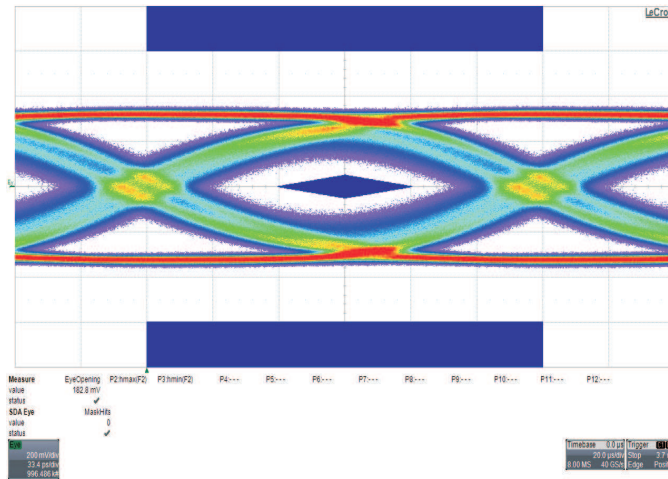

DE= 0dB, EQ = 0dB, Input = 20", Output = 4" + 3m Cable

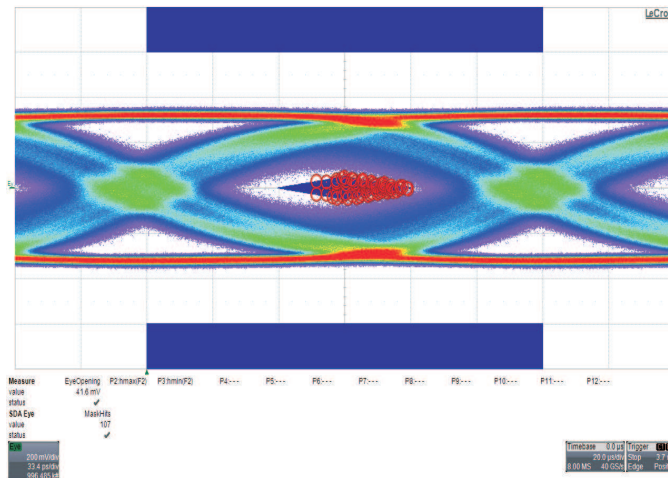

DE= 0dB, EQ = 7dB, Input = 24", Output = 4" + 3m Cable

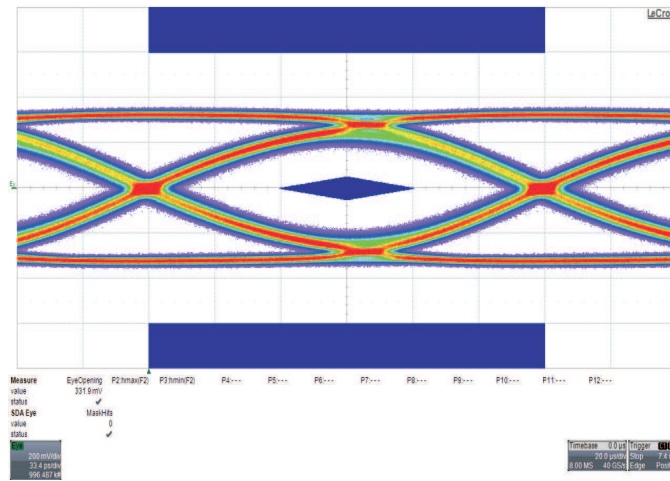

DE= 0dB, EQ = 7dB, Input = 32", Output = 4" + 3m Cable

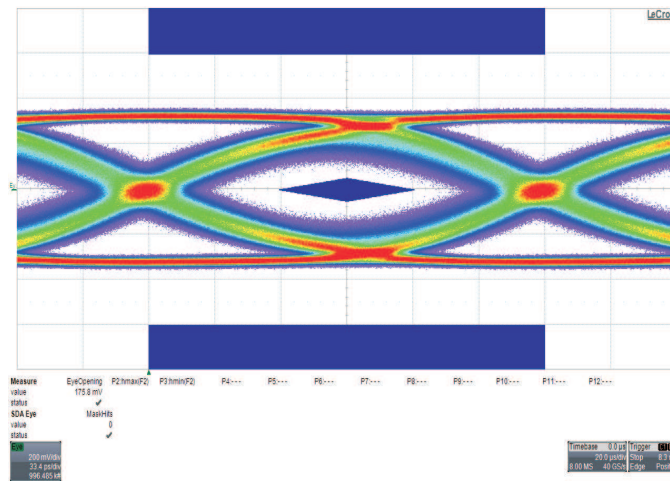

DE= 0dB, EQ = 7dB, Input = 36", Output = 4" + 3m Cable

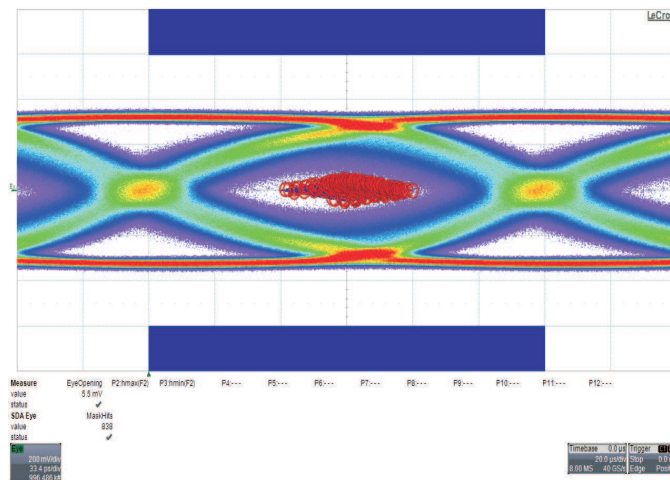

DE= 0dB, EQ = 15dB, Input = 36", Output = 4" + 3m Cable

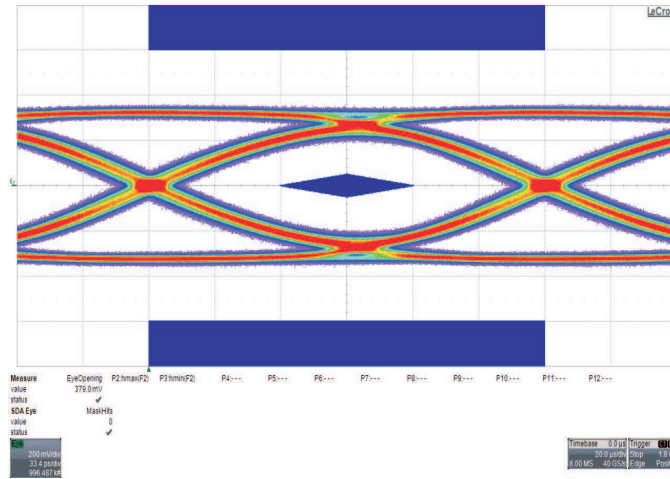

DE= 0dB, EQ = 15dB, Input = 48", Output = 4" + 3m Cable

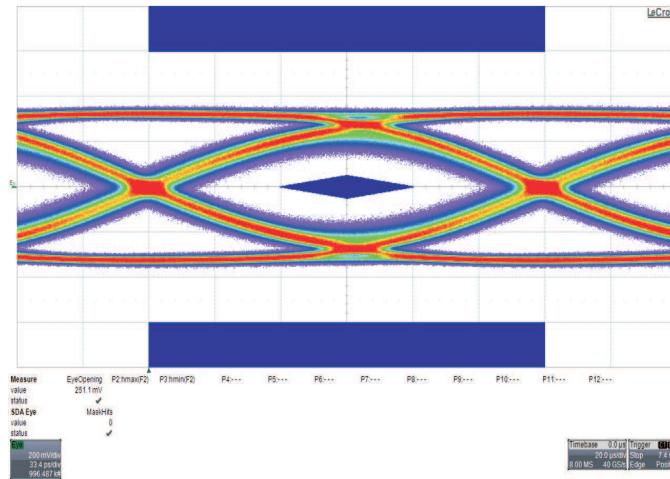

CASE II FIXED INPUT AND VARIABLE OUTPUT TRACE+ 3m CABLE

DE= 0dB, EQ = 7dB, Input = 12", Output = 4" + 3m Cable

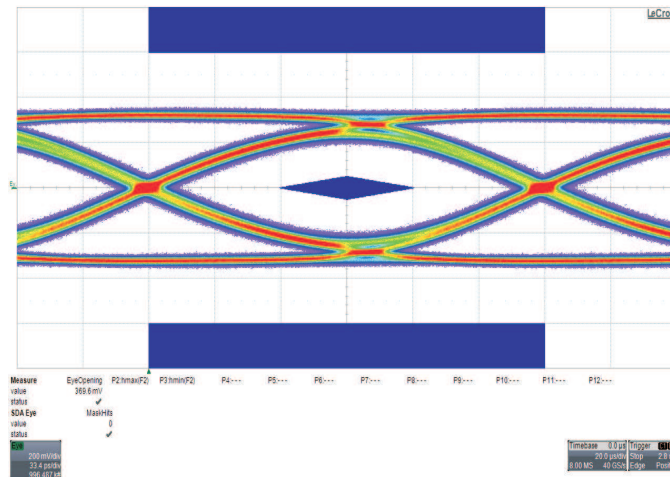

DE= 0dB, EQ = 7dB, Input = 12", Output = 8" + 3m Cable

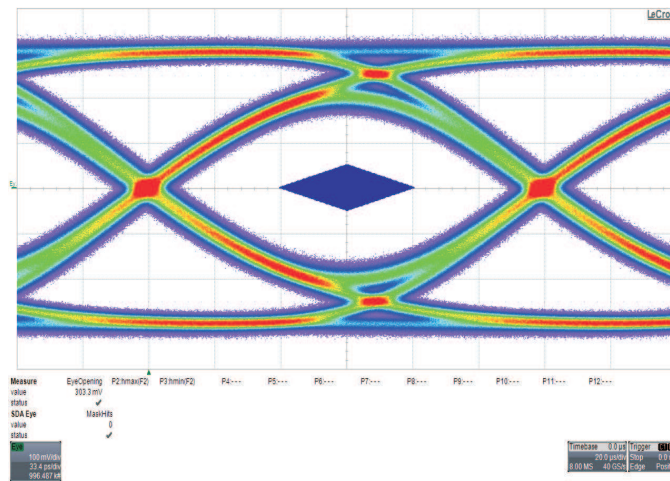

DE= 0dB, EQ = 7dB, Input = 12", Output = 12" + 3m Cable

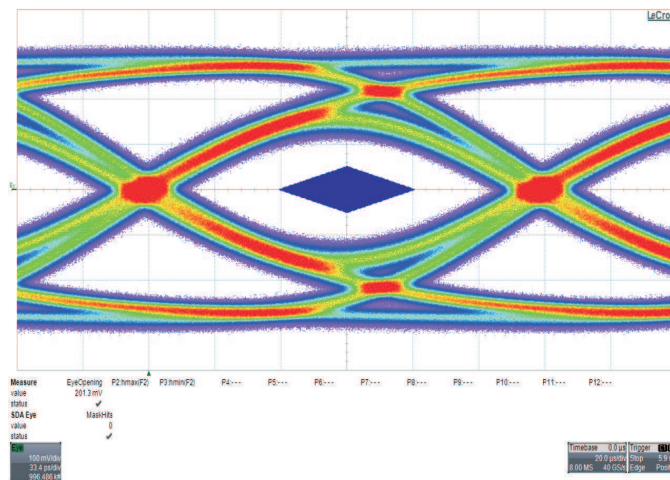

DE= 0dB, EQ = 7dB, Input = 12", Output = 16" + 3m Cable

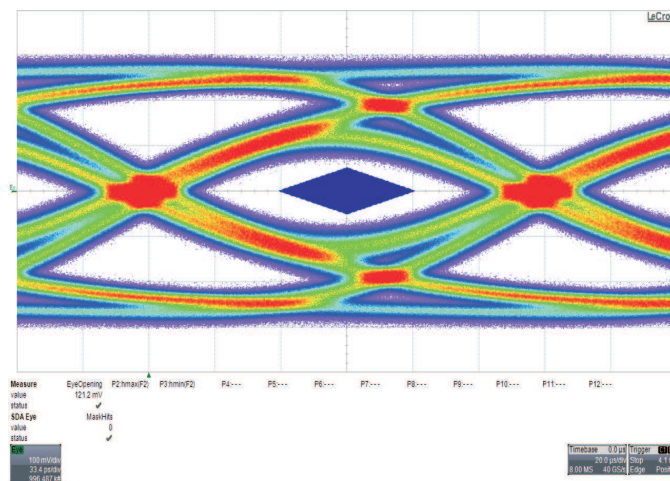

DE= 0dB, EQ = 7dB, Input = 12", Output = 20" + 3m Cable

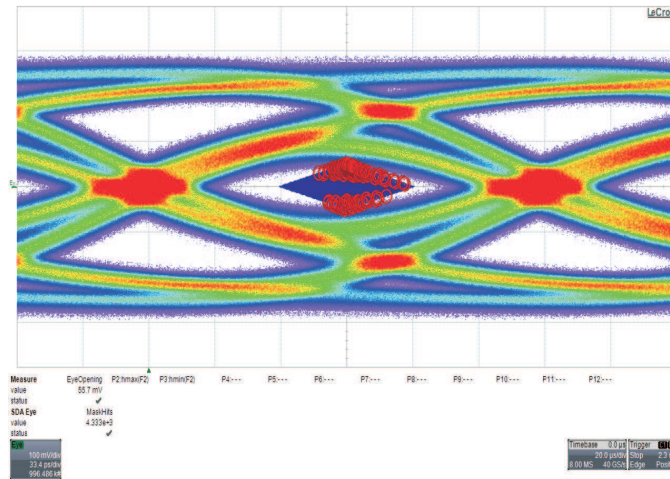

CASE III FIXED INPUT AND VARIABLE OUTPUT TRACE (No Cable)

DE= 0dB, EQ = 7dB, Input = 12", Output = 8"

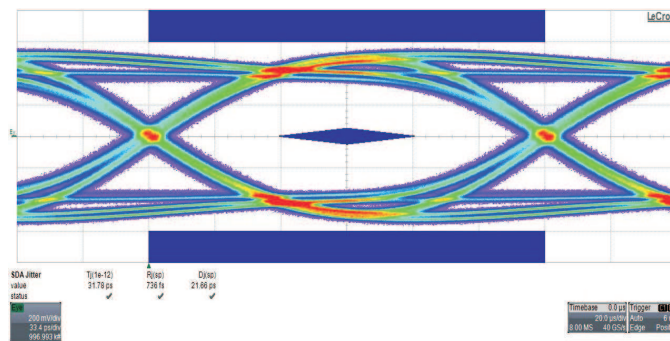

DE= 0dB, EQ = 7dB, Input = 12", Output = 32"

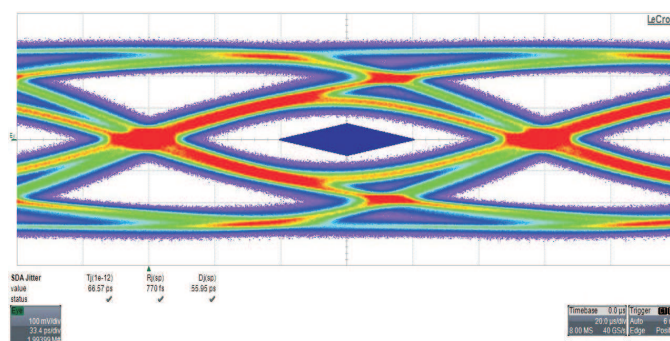

DE= 0dB, EQ = 7dB, Input = 12", Output = 36"

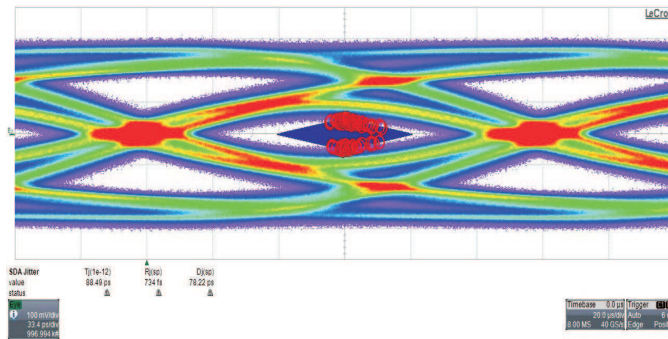

DE= -3.5dB, EQ = 7dB, Input = 12", Output = 36"

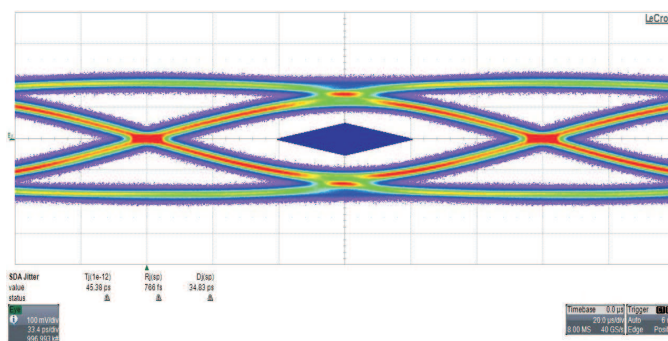

DE= -6.0dB, EQ = 7dB, Input = 12", Output = 40"

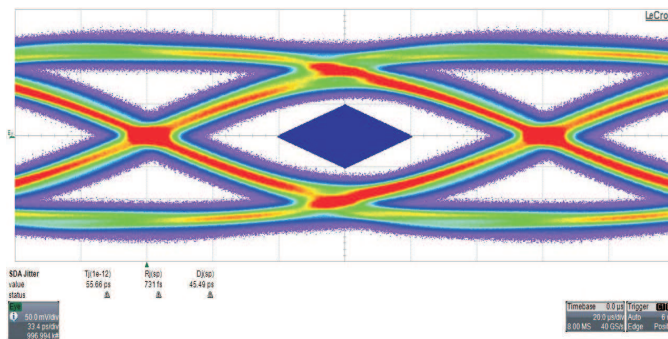

DE= -6.0dB, EQ = 7dB, Input = 12", Output = 44"

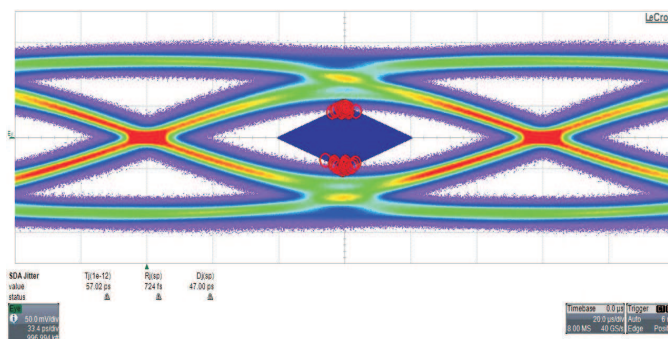

REVISION HISTORY

Changes from Original (March 2011) to Revision A	Page
• Changed the Block Diagram label From: CM/EN_RXD To: EN_RXD	2
• Changed From: CM To: RSVD in the THERMAL CHARACTERISTICS table Test Conditions	3
• Changed From: CM To: RSVD in the RECOMMENDED OPERATING CONDITIONS table Test Conditions	4
• Changed pin name From: CM To: RSVD in the Flow-Through Pin-Out illustration	8
• Changed pin name and description From: CM To: RSVD in the Pin Functions table	9
• Deleted CM and Device Functions columns from the Control Pins Settings of Table 2	9
• Deleted the USB Compliance Mode section	11

Changes from Revision A (September 2011) to Revision B	Page
• Changed the I/O type for the TX pins (11, 12, 22, 23) From: O, CML To: O, VML	9
• Changed the pin Description for the TX pins (11, 12, 22, 23) From: Non-inverting and inverting CML differential output for CH 1 and CH 2 To: Non-inverting and inverting VML differential output for CH 1 and CH 2	9

PACKAGING INFORMATION

Orderable Device	Status (1)	Package Type	Package Drawing	Pins	Package Qty	Eco Plan (2)	Lead/Ball Finish (6)	MSL Peak Temp (3)	Op Temp (°C)	Device Marking (4/5)	Samples
SN65LVPE502CPRGER	NRND	VQFN	RGE	24	3000	Green (RoHS & no Sb/Br)	CU NIPDAU	Level-2-260C-1 YEAR	0 to 85	502CP	
SN65LVPE502CPRGET	NRND	VQFN	RGE	24	250	Green (RoHS & no Sb/Br)	CU NIPDAU	Level-2-260C-1 YEAR	0 to 85	502CP	

(1) The marketing status values are defined as follows:

ACTIVE: Product device recommended for new designs.

LIFEBUY: TI has announced that the device will be discontinued, and a lifetime-buy period is in effect.

NRND: Not recommended for new designs. Device is in production to support existing customers, but TI does not recommend using this part in a new design.

PREVIEW: Device has been announced but is not in production. Samples may or may not be available.

OBSELETE: TI has discontinued the production of the device.

(2) **RoHS:** TI defines "RoHS" to mean semiconductor products that are compliant with the current EU RoHS requirements for all 10 RoHS substances, including the requirement that RoHS substance do not exceed 0.1% by weight in homogeneous materials. Where designed to be soldered at high temperatures, "RoHS" products are suitable for use in specified lead-free processes. TI may reference these types of products as "Pb-Free".

RoHS Exempt: TI defines "RoHS Exempt" to mean products that contain lead but are compliant with EU RoHS pursuant to a specific EU RoHS exemption.

Green: TI defines "Green" to mean the content of Chlorine (Cl) and Bromine (Br) based flame retardants meet JS709B low halogen requirements of <=1000ppm threshold. Antimony trioxide based flame retardants must also meet the <=1000ppm threshold requirement.

(3) MSL, Peak Temp. - The Moisture Sensitivity Level rating according to the JEDEC industry standard classifications, and peak solder temperature.

(4) There may be additional marking, which relates to the logo, the lot trace code information, or the environmental category on the device.

(5) Multiple Device Markings will be inside parentheses. Only one Device Marking contained in parentheses and separated by a "~" will appear on a device. If a line is indented then it is a continuation of the previous line and the two combined represent the entire Device Marking for that device.

(6) Lead/Ball Finish - Orderable Devices may have multiple material finish options. Finish options are separated by a vertical ruled line. Lead/Ball Finish values may wrap to two lines if the finish value exceeds the maximum column width.

Important Information and Disclaimer:The information provided on this page represents TI's knowledge and belief as of the date that it is provided. TI bases its knowledge and belief on information provided by third parties, and makes no representation or warranty as to the accuracy of such information. Efforts are underway to better integrate information from third parties. TI has taken and continues to take reasonable steps to provide representative and accurate information but may not have conducted destructive testing or chemical analysis on incoming materials and chemicals. TI and TI suppliers consider certain information to be proprietary, and thus CAS numbers and other limited information may not be available for release.

In no event shall TI's liability arising out of such information exceed the total purchase price of the TI part(s) at issue in this document sold by TI to Customer on an annual basis.

TAPE AND REEL INFORMATION

QUADRANT ASSIGNMENTS FOR PIN 1 ORIENTATION IN TAPE

*All dimensions are nominal

Device	Package Type	Package Drawing	Pins	SPQ	Reel Diameter (mm)	Reel Width W1 (mm)	A0 (mm)	B0 (mm)	K0 (mm)	P1 (mm)	W (mm)	Pin1 Quadrant
SN65LVPE502CPRGER	VQFN	RGE	24	3000	330.0	12.4	4.25	4.25	1.15	8.0	12.0	Q2
SN65LVPE502CPRGET	VQFN	RGE	24	250	180.0	12.4	4.25	4.25	1.15	8.0	12.0	Q2

TAPE AND REEL BOX DIMENSIONS

*All dimensions are nominal

Device	Package Type	Package Drawing	Pins	SPQ	Length (mm)	Width (mm)	Height (mm)
SN65LVPE502CPRGER	VQFN	RGE	24	3000	367.0	367.0	35.0
SN65LVPE502CPRGET	VQFN	RGE	24	250	210.0	185.0	35.0

RGE 24

GENERIC PACKAGE VIEW

VQFN - 1 mm max height

PLASTIC QUAD FLATPACK - NO LEAD



Images above are just a representation of the package family, actual package may vary.
Refer to the product data sheet for package details.

4204104/H

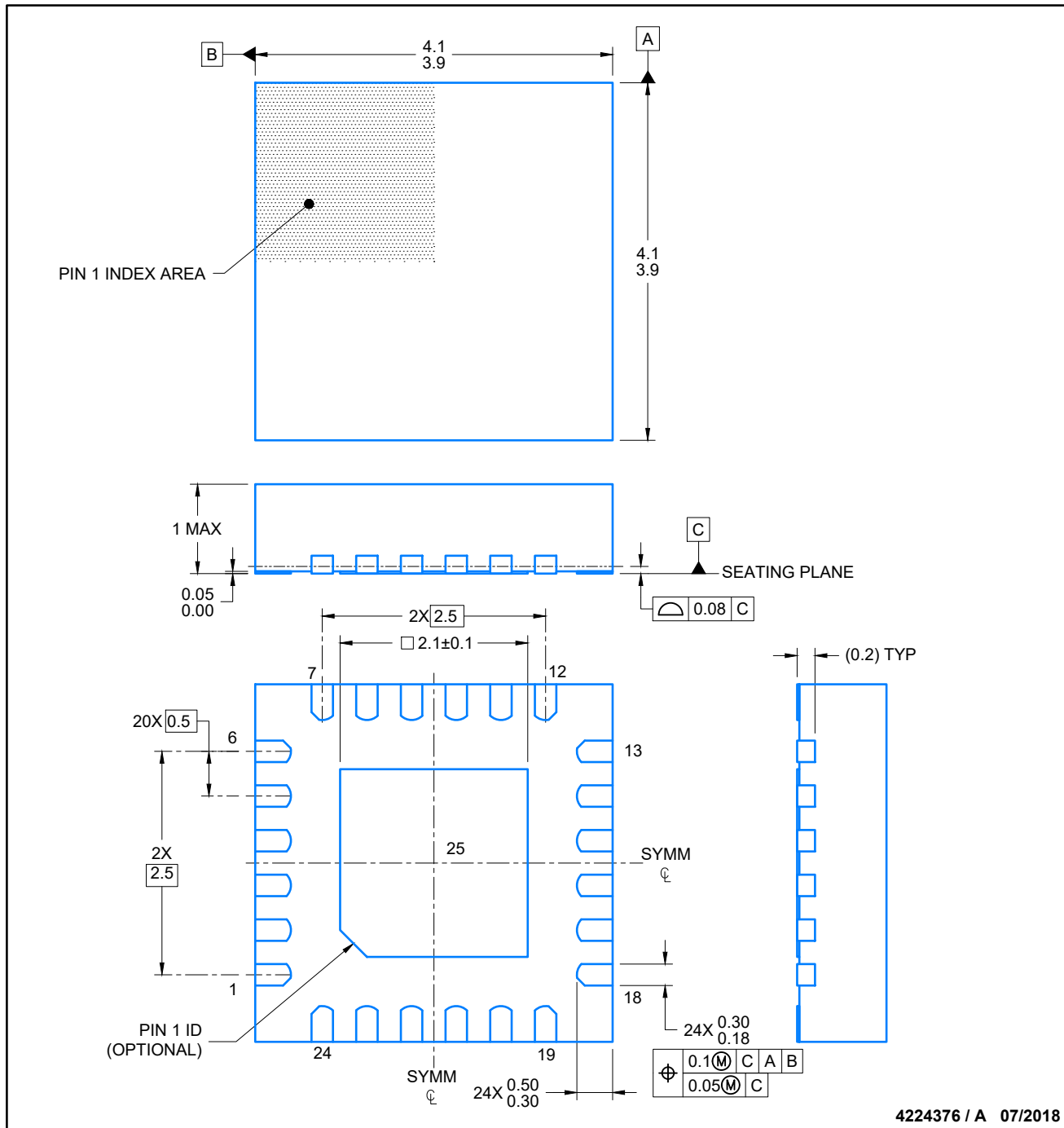

4224376 / A 07/2018

NOTES:

1. All linear dimensions are in millimeters. Any dimensions in parenthesis are for reference only. Dimensioning and tolerancing per ASME Y14.5M.
2. This drawing is subject to change without notice.
3. The package thermal pad must be soldered to the printed circuit board for thermal and mechanical performance.

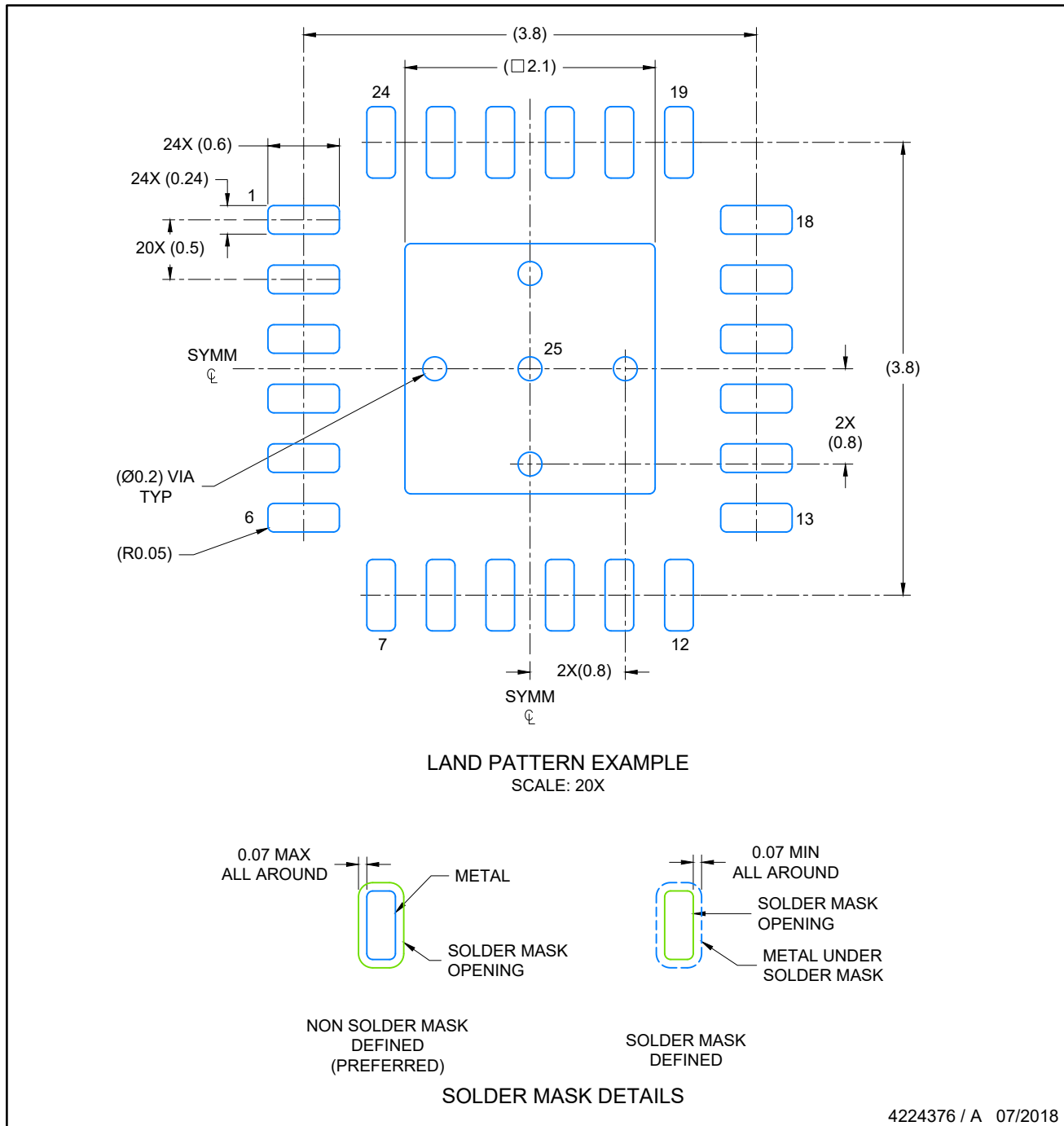

NOTES: (continued)

4. This package is designed to be soldered to a thermal pad on the board. For more information, see Texas Instruments literature number SLUA271 (www.ti.com/lit/slua271).
5. Solder mask tolerances between and around signal pads can vary based on board fabrication site.

EXAMPLE STENCIL DESIGN

VQFN - 1 mm max height

RGE0024C

PLASTIC QUAD FLATPACK- NO LEAD

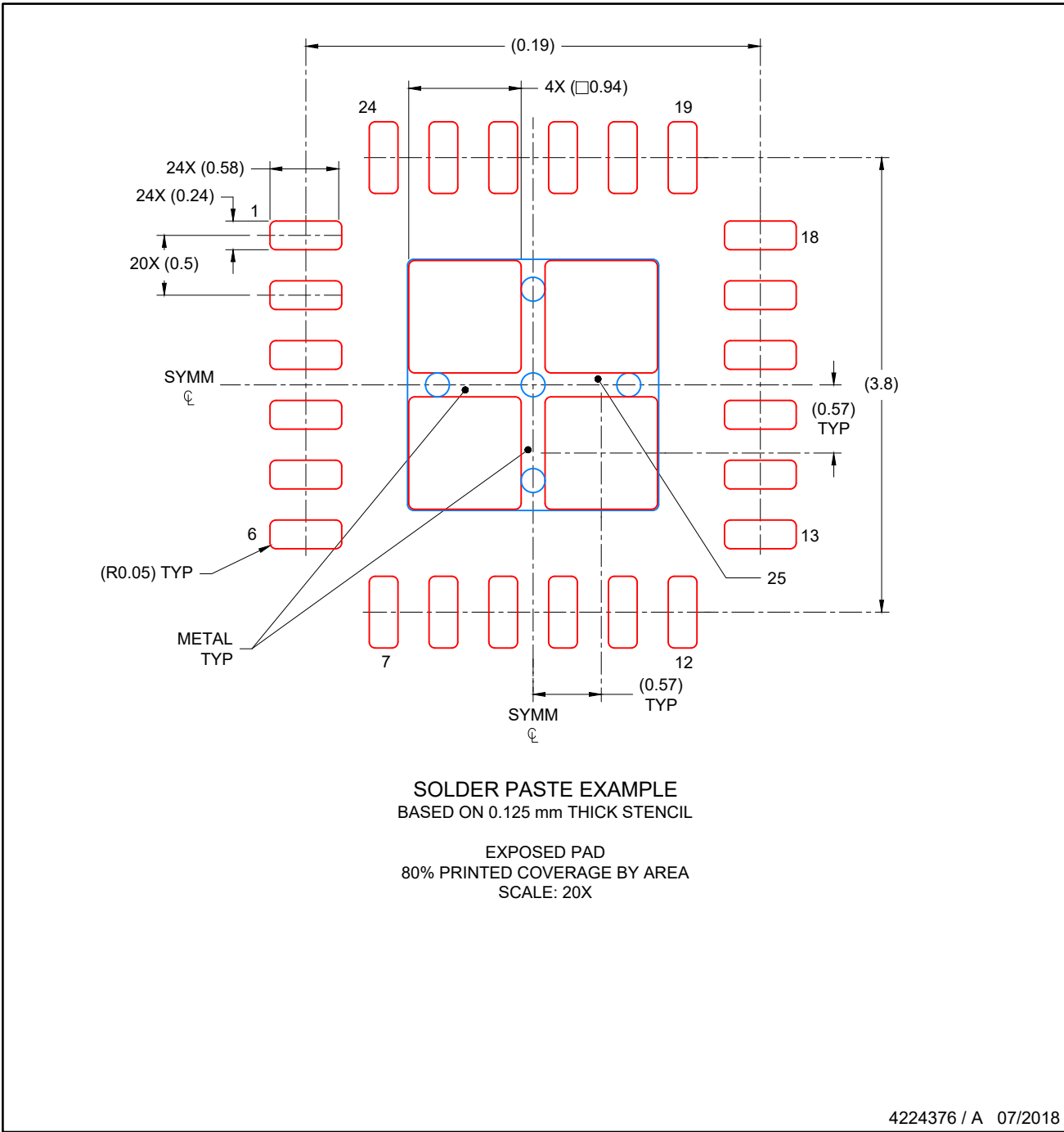

NOTES: (continued)

- 6. Laser cutting apertures with trapezoidal walls and rounded corners may offer better paste release. IPC-7525 may have alternate design recommendations..

IMPORTANT NOTICE

Texas Instruments Incorporated (TI) reserves the right to make corrections, enhancements, improvements and other changes to its semiconductor products and services per JESD46, latest issue, and to discontinue any product or service per JESD48, latest issue. Buyers should obtain the latest relevant information before placing orders and should verify that such information is current and complete.

TI's published terms of sale for semiconductor products (<http://www.ti.com/sc/docs/stdterms.htm>) apply to the sale of packaged integrated circuit products that TI has qualified and released to market. Additional terms may apply to the use or sale of other types of TI products and services.

Reproduction of significant portions of TI information in TI data sheets is permissible only if reproduction is without alteration and is accompanied by all associated warranties, conditions, limitations, and notices. TI is not responsible or liable for such reproduced documentation. Information of third parties may be subject to additional restrictions. Resale of TI products or services with statements different from or beyond the parameters stated by TI for that product or service voids all express and any implied warranties for the associated TI product or service and is an unfair and deceptive business practice. TI is not responsible or liable for any such statements.

Buyers and others who are developing systems that incorporate TI products (collectively, "Designers") understand and agree that Designers remain responsible for using their independent analysis, evaluation and judgment in designing their applications and that Designers have full and exclusive responsibility to assure the safety of Designers' applications and compliance of their applications (and of all TI products used in or for Designers' applications) with all applicable regulations, laws and other applicable requirements. Designer represents that, with respect to their applications, Designer has all the necessary expertise to create and implement safeguards that (1) anticipate dangerous consequences of failures, (2) monitor failures and their consequences, and (3) lessen the likelihood of failures that might cause harm and take appropriate actions. Designer agrees that prior to using or distributing any applications that include TI products, Designer will thoroughly test such applications and the functionality of such TI products as used in such applications.

TI's provision of technical, application or other design advice, quality characterization, reliability data or other services or information, including, but not limited to, reference designs and materials relating to evaluation modules, (collectively, "TI Resources") are intended to assist designers who are developing applications that incorporate TI products; by downloading, accessing or using TI Resources in any way, Designer (individually or, if Designer is acting on behalf of a company, Designer's company) agrees to use any particular TI Resource solely for this purpose and subject to the terms of this Notice.

TI's provision of TI Resources does not expand or otherwise alter TI's applicable published warranties or warranty disclaimers for TI products, and no additional obligations or liabilities arise from TI providing such TI Resources. TI reserves the right to make corrections, enhancements, improvements and other changes to its TI Resources. TI has not conducted any testing other than that specifically described in the published documentation for a particular TI Resource.

Designer is authorized to use, copy and modify any individual TI Resource only in connection with the development of applications that include the TI product(s) identified in such TI Resource. NO OTHER LICENSE, EXPRESS OR IMPLIED, BY ESTOPPEL OR OTHERWISE TO ANY OTHER TI INTELLECTUAL PROPERTY RIGHT, AND NO LICENSE TO ANY TECHNOLOGY OR INTELLECTUAL PROPERTY RIGHT OF TI OR ANY THIRD PARTY IS GRANTED HEREIN, including but not limited to any patent right, copyright, mask work right, or other intellectual property right relating to any combination, machine, or process in which TI products or services are used. Information regarding or referencing third-party products or services does not constitute a license to use such products or services, or a warranty or endorsement thereof. Use of TI Resources may require a license from a third party under the patents or other intellectual property of the third party, or a license from TI under the patents or other intellectual property of TI.

TI RESOURCES ARE PROVIDED "AS IS" AND WITH ALL FAULTS. TI DISCLAIMS ALL OTHER WARRANTIES OR REPRESENTATIONS, EXPRESS OR IMPLIED, REGARDING RESOURCES OR USE THEREOF, INCLUDING BUT NOT LIMITED TO ACCURACY OR COMPLETENESS, TITLE, ANY EPIDEMIC FAILURE WARRANTY AND ANY IMPLIED WARRANTIES OF MERCHANTABILITY, FITNESS FOR A PARTICULAR PURPOSE, AND NON-INFRINGEMENT OF ANY THIRD PARTY INTELLECTUAL PROPERTY RIGHTS. TI SHALL NOT BE LIABLE FOR AND SHALL NOT DEFEND OR INDEMNIFY DESIGNER AGAINST ANY CLAIM, INCLUDING BUT NOT LIMITED TO ANY INFRINGEMENT CLAIM THAT RELATES TO OR IS BASED ON ANY COMBINATION OF PRODUCTS EVEN IF DESCRIBED IN TI RESOURCES OR OTHERWISE. IN NO EVENT SHALL TI BE LIABLE FOR ANY ACTUAL, DIRECT, SPECIAL, COLLATERAL, INDIRECT, PUNITIVE, INCIDENTAL, CONSEQUENTIAL OR EXEMPLARY DAMAGES IN CONNECTION WITH OR ARISING OUT OF TI RESOURCES OR USE THEREOF, AND REGARDLESS OF WHETHER TI HAS BEEN ADVISED OF THE POSSIBILITY OF SUCH DAMAGES.

Unless TI has explicitly designated an individual product as meeting the requirements of a particular industry standard (e.g., ISO/TS 16949 and ISO 26262), TI is not responsible for any failure to meet such industry standard requirements.

Where TI specifically promotes products as facilitating functional safety or as compliant with industry functional safety standards, such products are intended to help enable customers to design and create their own applications that meet applicable functional safety standards and requirements. Using products in an application does not by itself establish any safety features in the application. Designers must ensure compliance with safety-related requirements and standards applicable to their applications. Designer may not use any TI products in life-critical medical equipment unless authorized officers of the parties have executed a special contract specifically governing such use. Life-critical medical equipment is medical equipment where failure of such equipment would cause serious bodily injury or death (e.g., life support, pacemakers, defibrillators, heart pumps, neurostimulators, and implantables). Such equipment includes, without limitation, all medical devices identified by the U.S. Food and Drug Administration as Class III devices and equivalent classifications outside the U.S.

TI may expressly designate certain products as completing a particular qualification (e.g., Q100, Military Grade, or Enhanced Product). Designers agree that it has the necessary expertise to select the product with the appropriate qualification designation for their applications and that proper product selection is at Designers' own risk. Designers are solely responsible for compliance with all legal and regulatory requirements in connection with such selection.

Designer will fully indemnify TI and its representatives against any damages, costs, losses, and/or liabilities arising out of Designer's non-compliance with the terms and provisions of this Notice.