

PART NUMBER	SML-LXT0805SBW-TR	REV.	G
DATE	E.C.N. NUMBER AND REVISION COMMENTS		REV.
02.25.02	E.C.N. #10814.		A
03.22.04	E.C.N. #10967.		B
08.12.05	E.C.N. #11248.		C
09.30.09	E.C.N. #11508.		D
09.26.11	E.C.N. #10BRDR. & REDRAWN.		E
03.14.15	E.C.N. #11935		F
12.17.19	ECN-Lumex201900133		G

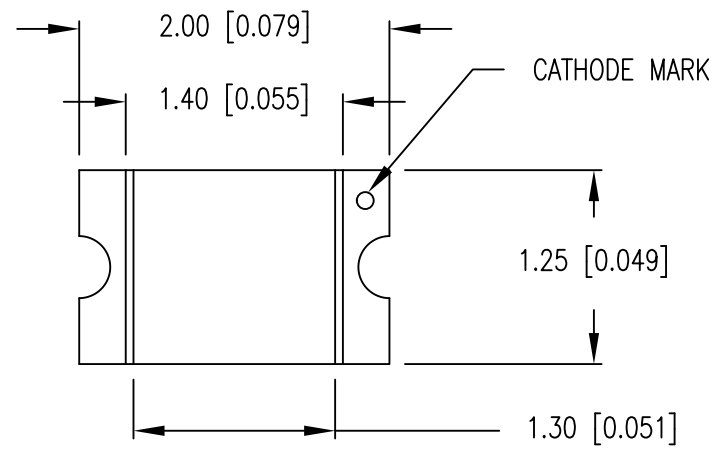

CAUTION: STATIC SENSITIVE DEVICE
FOLLOW PROPER E.S.D. HANDLING PROCEDURES
WHEN WORKING WITH THIS PART.

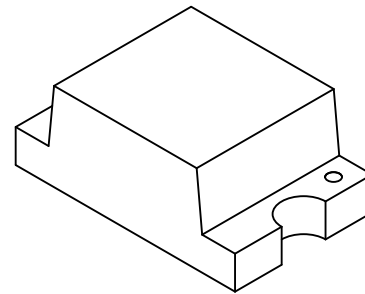

ELECTRO-OPTICAL CHARACTERISTICS $T_A=25^\circ\text{C}$ $I_f=20\text{mA}$

PARAMETER	MIN	TYP	MAX	UNITS	TEST COND
PEAK WAVELENGTH		470		nm	
FORWARD VOLTAGE		3.3	3.9	V_f	
REVERSE VOLTAGE	5.0			V_r	$I_r=100\mu\text{A}$
AXIAL INTENSITY		71.5		mcd	$I_f=20\text{mA}$
VIEWING ANGLE		130		2x theta	
EMITTED COLOR:	BLUE				
EPOXY LENS FINISH:	MILKY WHITE DIFFUSED				

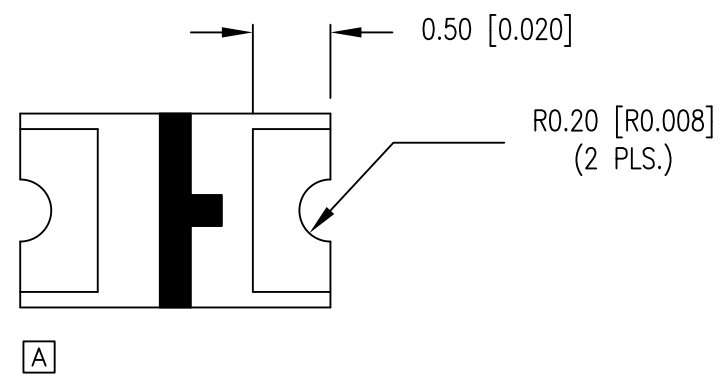
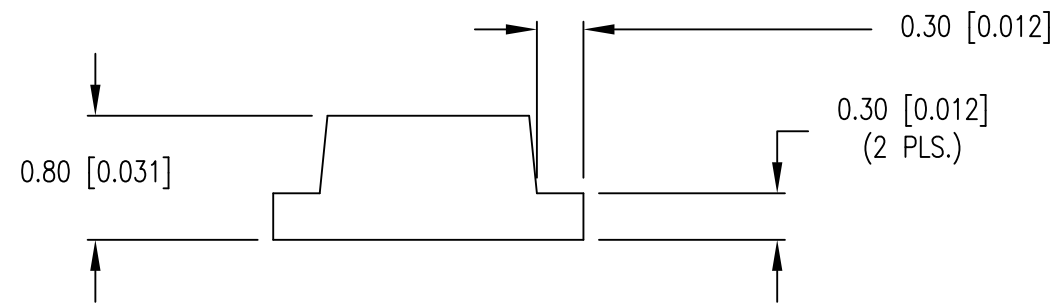

LEAD FREE REFLOW PROFILE

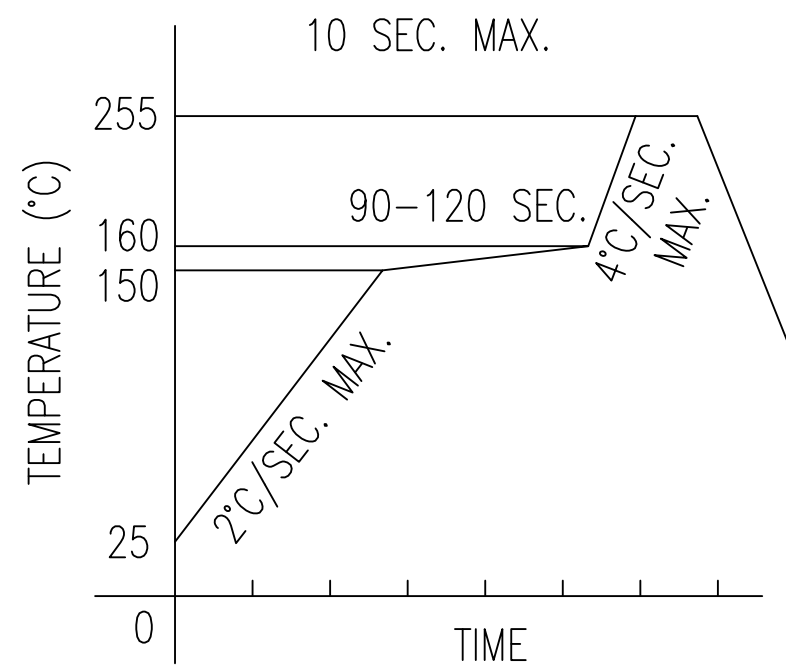

TOTAL TIME ABOVE 220°C IS 60 SECONDS MAX.

LIMITS OF SAFE OPERATION AT 25°C

PARAMETER	MAX	UNITS
PEAK FORWARD CURRENT*	60	mA
STEADY CURRENT	20	mA
POWER DISSIPATION	78	mW
DERATE FROM 25°C	-1.2	mW/°C
OPERATING TEMP.	-40 TO +85	°C
STORAGE TEMP.	-40 TO +100	°C

* $t < 10\mu\text{s}$

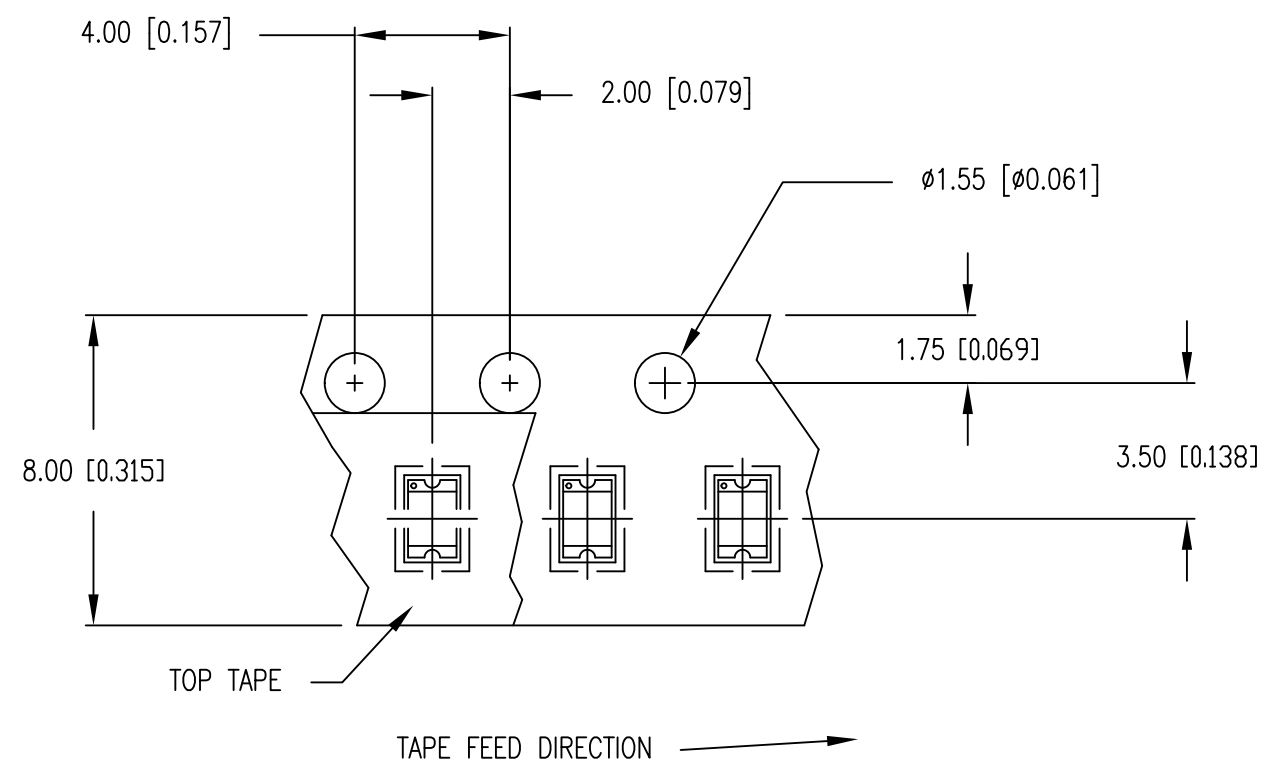

RECOMMENDED SOLDER PAD LAYOUT

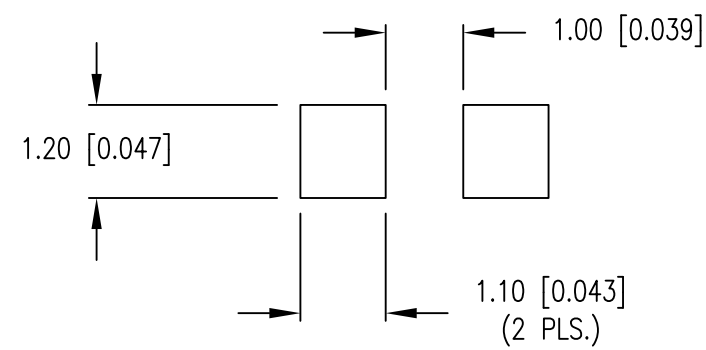

NOTES:

- 4K PER REEL
- CATHODE IS ORIENTED TOWARDS THE TAPE SPROCKET HOLE.

CAUTION: MOISTURE SENSITIVE DEVICE
PER JEDEC LEVEL 2a STANDARDS

*UNLESS OTHERWISE SPECIFIED TOLERANCES PER DECIMAL PRECISION ARE: X=±1 (±0.039), X.X=±0.5 (±0.020), X.XX=±0.25 (±0.010), X.XXX=±0.127 (±0.005). LEAD SIZE=±0.05 (±0.002), LEAD LENGTH=±0.75 (±0.030). MIN.= +DECIMAL PRECISION -0.00 MAX.= +0.00 -DECIMAL PRECISION



425 N. GARY AVE.
CAROL STREAM, IL 60188
PHONE: 800.278.5666
FAX: 630.315.2150
WEB: WWW.LUMEX.COM

2.0x1.25mm THIN PCB SURFACE MOUNT, 430nm SUPER BLUE LED, MILKY WHITE DIFFUSED LENS, TAPE & REEL.

THE SPECIFICATIONS MAY CHANGE AT ANY TIME WITHOUT NOTICE.

CONFIDENTIAL INFORMATION
THE INFORMATION CONTAINED IN THIS DOCUMENT IS THE PROPERTY OF LUMEX INC. EXCEPT AS SPECIFICALLY AUTHORIZED IN WRITING BY LUMEX INC., THE HOLDER OF THIS DOCUMENT SHALL KEEP ALL INFORMATION CONTAINED HEREIN CONFIDENTIAL AND SHALL PROTECT SAME IN WHOLE OR IN PART FROM DISCLOSURE AND DISSEMINATION TO ALL THIRD PARTIES.

DATE:	12.17.19	DRAWN BY:	C.S.
PAGE:	1 OF 1	CHKD BY:	E.C.
SCALE:	NTS	APRVD BY:	G.Y.
UNIT:	mm [INCH]		(Rb)