

<b>PART NUMBER</b>	SML-LX1206YC-TR	<b>REV</b>	O
<b>REV</b>	<b>E.C.N. NUMBER AND REVISION COMMENTS</b>	<b>DATE</b>	
A	ADDED TAPE DIRECTION AND POLARITY.	11.01.95	
B	E.C.N. #10BRDR. & REDRAWN IN 3D.	12.18.97	
C	E.C.N. #10644. & REDRAWN IN 3D.	07.18.00	
D	E.C.N. #10814.	12.03.01	
E	E.C.N. #10967.	03.14.03	
F	E.C.N. #11148.	01.20.05	
G	E.C.N. #11466.	01.07.08	
H	E.C.N. #11508.	03.09.09	
I	E.C.N. #11644.	07.19.10	
J	E.C.N. #10BRDR. & REDRAWN IN 3D.	04.20.11	
K	E.C.N. #11829.	08.08.12	
L	E.C.N. #10BRDR.	10.31.14	
M	ECN-Lumex201700127	12.18.17	
N	ECN-Lumex201900133	11.18.19	
O	ECN-Lumex202100079	11.07.22	

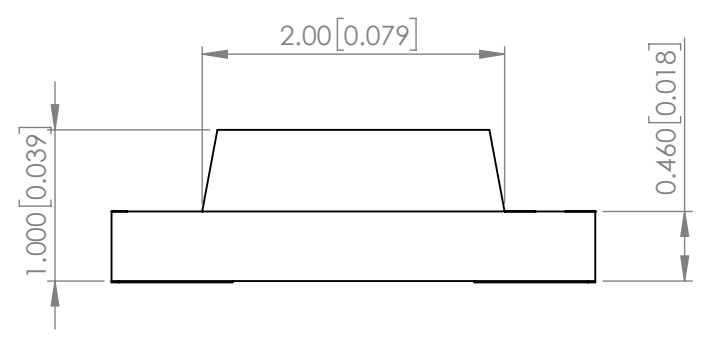

**RECOMMENDED SOLDER PAD LAYOUT**

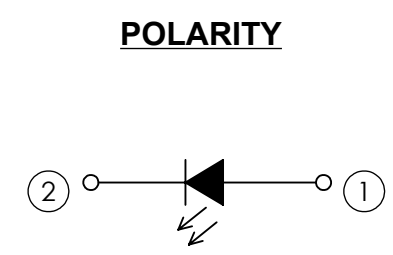
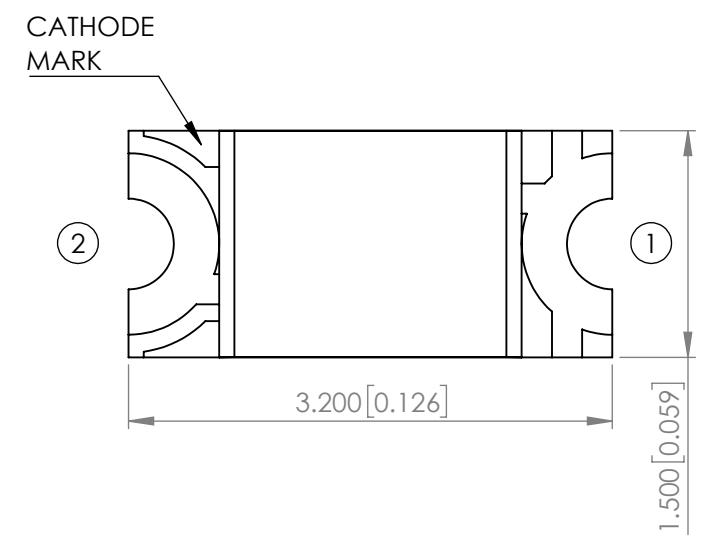
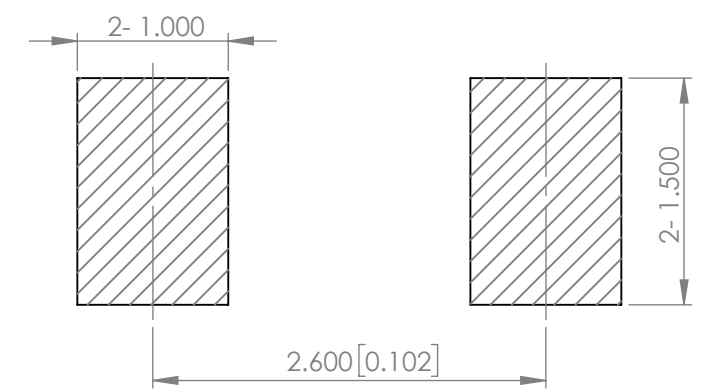
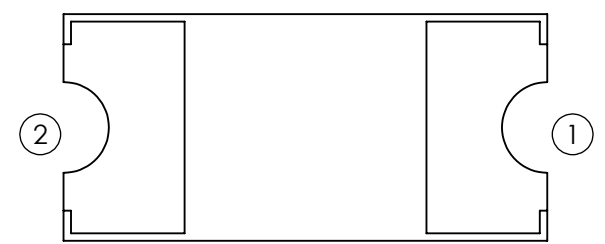

**ELECTRO-OPTICAL CHARACTERISTIC TA=25°C**

PARAMETER	MIN	TYP	MAX	UNITS	TEST COND
PEAK WAVELENGTH	-	590	-	nm	If=20mA
FORWARD VOLTAGE	-	2.0	2.4	Vf	If=20mA
REVERSE CURRENT	-	-	10	uA	VR=5V
LUMINOUS INTENSITY	-	39	-	mcd	If=20mA
VIEWING ANGLE	-	130	-	2x theta1/2	-
EMITTED COLOR	YELLOW				
EPOXY LENS FINISH	WATER CLEAR				

**ABSOLUTE MAXIMUM RATINGS TA=25°C**

PARAMETER	MAX	UNITS
PEAK FORWARD CURRENT*	60	mA
FORWARD CURRENT	25	mA
REVERSE VOLTAGE	5	V
POWER DISSIPATION	60	mW
STORAGE TEMPERATURE	-40 TO +90	°C
OPERATING TEMPERATURE	-40 TO +85	°C

\* 1/10 DUTY CYCLE 0.1ms PULSE.

**MOISTURE SENSITIVE DEVICE  
PER JEDEC LEVEL 3 STANDARDS**

\*UNLESS OTHERWISE SPECIFIED TOLERANCES PER DECIMAL PRECISION ARE: X=±1 (±0.039), X.X=±0.5 (±0.020), X.XX=±0.25 (±0.010), X.XXX=±0.127 (±0.005). LEAD SIZE=±0.05 (±0.002), LEAD LENGTH=±0.75 (±0.030). MIN= <sup>+DECIMAL PRECISION</sup>/<sub>-0.00</sub> MAX= <sup>+0.00</sup>/<sub>-DECIMAL PRECISION</sub>

**PROFILE**

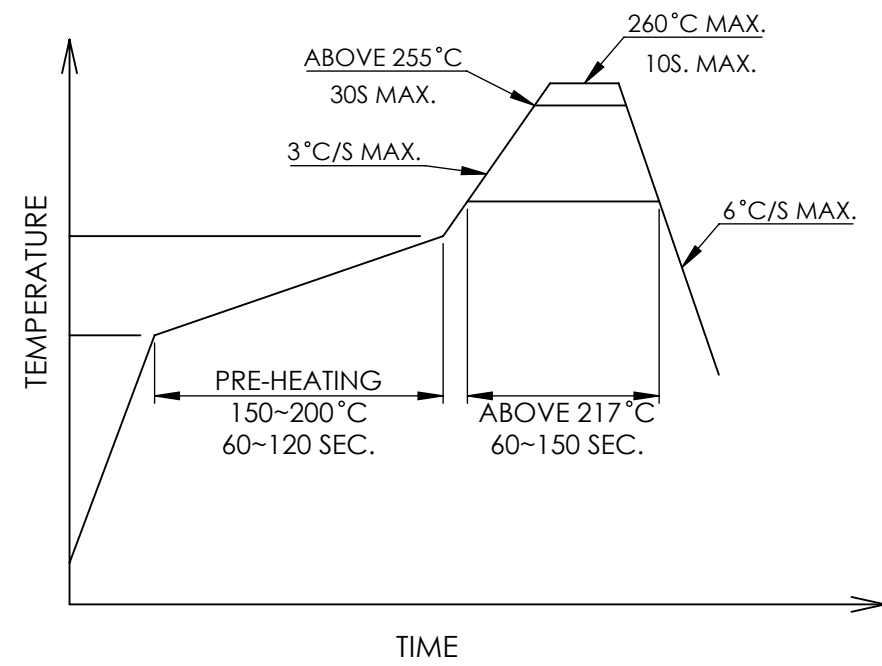

**CARRIER TAPE DIMENSION**

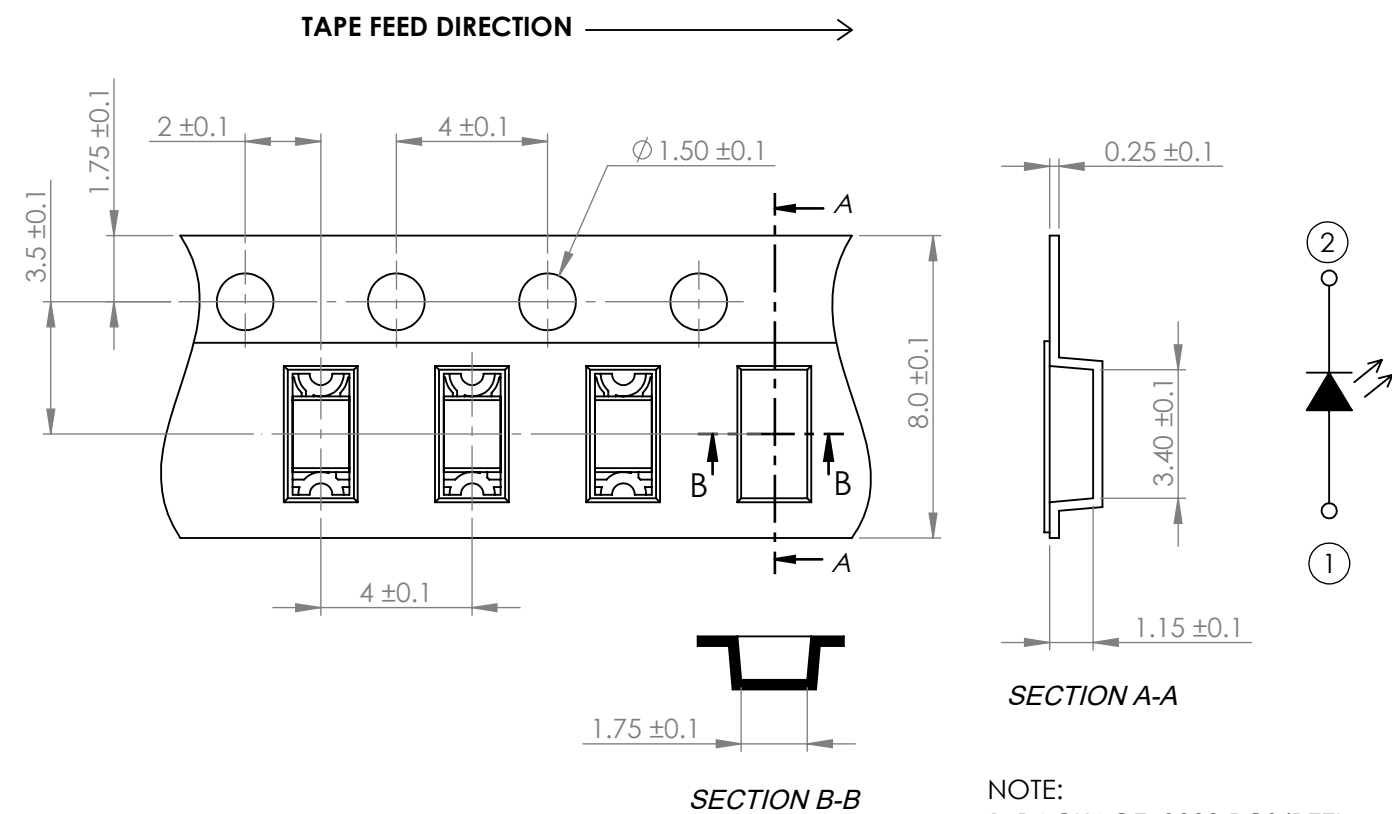

NOTE:  
1. PACKAGE: 3000 PCS/REEL.

\*UNLESS OTHERWISE SPECIFIED TOLERANCES PER DECIMAL PRECISION ARE: X=±1 (±0.039), X.X=±0.5 (±0.020), X.XX=±0.25 (±0.010), X.XXX=±0.127 (±0.005). LEAD SIZE=±0.05 (±0.002), LEAD LENGTH=±0.75 (±0.030). MIN= <sup>+DECIMAL PRECISION</sup>/<sub>-0.00</sub> MAX= <sup>+0.00</sup>/<sub>-DECIMAL PRECISION</sub>

 <p>425 N. GARY AVE. CAROL STREAM, IL 60188 PHONE : 800-278-5666 FAX : 630-315-2150 WEB : WWW.LUMEX.COM</p>	3.2(L)*1.5(W)*1.0(H)mm, PCB SURFACE MOUNT TOP VIEW LED, 590nm YELLOW, WATER CLEAR LENS, TAPE & REEL		DATE : 2017.12.18	DRAWN BY : C.C.	
	**THE SPECIFICATIONS MAY CHANGE AT ANY TIME WITHOUT NOTICE.**			PAGE : 2 OF 2	CHKD BY : G.Y.
	CONFIDENTIAL INFORMATION THE INFORMATION CONTAINED IN THIS DOCUMENT IS THE PROPERTY OF LUMEX INC. EXCEPT AS SPECIFICALLY AUTHORIZED IN WRITING BY LUMEX INC., THE HOLDER OF THIS DOCUMENT SHALL KEEP ALL INFORMATION CONTAINED HEREIN CONFIDENTIAL AND SHALL PROTECT SAME IN WHOLE OR IN PART FROM DISCLOSURE AND DISSEMINATION TO ALL THIRD PARTIES.			SCALE : NTF	APRVD BY : E.C.
				UNIT : mm [INCH]	(No)