



SPECIFICATION SHEET

| | |
|--------------------------------|--|
| SPECIFICATION SHEET NO. | P1102 - SMF050CAS050CA |
| DATE | Nov. 02, 2022 |
| REVISION | A1 |
| DESCRIPTION | SMD Transient Voltage Suppressor (TVs) Diodes, SMF/SOD-123FL series, SMF5.0CA Type, 2 Pads, Bidirectional Type Stand-off Voltage 5.0V, Peak Pulse Current: 21.7A Operating Temp. Range -55°C ~+150°C Package in Tape/Reel, 3000pcs/Reel RoHS/RoHS III compliant |
| CUSTOMER | |
| CUSTOMER PART NUMBER | |
| CROSS REF. PART NUMBER | |
| ORIGINAL PART NUMBER | MDD SMF5.0CA |
| PART CODE | SMF050CAS050CA |

| | | | |
|-------------------------|---|--|---|
| VENDOR APPROVE | | | |
| Issued/Checked/Approved |  |  |  |
| DATE: Nov. 02, 2022 | | | |

| | |
|-------------------------|--|
| CUSTOMER APPROVE | |
| | |
| DATE: | |

11/3/2022

SMD TRANSIENT VOLTAGE SUPPRESSORS DIODES SMF SERIES

MAIN FEATURE

- Low profile package
- Glass passivated chip junction
- Low inductance
- Plastic package has Underwriters Laboratory Flammability



APPLICATION

- For SMD application

RFQ

[Request For Quotation](#)

PART CODE GUIDE

| SMF | 050CA | S | 050CA |
|-----|-------|---|-------|
| 1 | 2 | 3 | 4 |

- 1) **SMF**: SMD Transient Voltage Suppressor (TVs) Diodes, SMF/SOD-123FL series
- 2) **050CA**: Type code for original part number SMF5.0CA
- 3) **S**: Package code, Tape/reel, 3000pcs/reel.
- 4) **050CA**: Marking code for “5.0CA” on the case surface, Different Marking for different specification.

SMD TRANSIENT VOLTAGE SUPPRESSORS DIODES SMF SERIES

MORE ITEMS AVAILABLE- Unidirectional Type

| | | | | |
|----------------|----------------|----------------|----------------|----------------|
| SMF050A00S050A | SMF060A00S060A | SMF065A00S065A | SMF070A00S070A | SMF075A00S075A |
| SMF080A00S080A | SMF085A00S085A | SMF090A00S090A | SMF10A0000S10A | SMF11A0000S11A |
| SMF12A0000S12A | SMF13A0000S13A | SMF14A0000S14A | SMF15A0000S15A | SMF16A0000S16A |
| SMF17A0000S17A | SMF18A0000S18A | SMF20A0000S20A | SMF22A0000S22A | SMF24A0000S24A |
| SMF26A0000S26A | SMF28A0000S28A | SMF30A0000S30A | SMF33A0000S33A | SMF36A0000S36A |
| SMF40A0000S40A | SMF43A0000S43A | SMF45A0000S45A | SMF48A0000S48A | SMF51A0000S51A |
| SMF54A0000S54A | SMF58A0000S58A | SMF60A0000S60A | SMF64A0000S64A | SMF70A0000S70A |
| SMF75A0000S75A | SMF78A0000S78A | SMF85A0000S85A | SMF90A0000S90A | SMF100A00S100A |
| SMF110A00S110A | SMF120A00S120A | SMF130A00S130A | SMF150A00S150A | SMF160A00S160A |
| SMF170A00S170A | SMF180A00S180A | SMF200A00S200A | SMF220A00S220A | SMF250A00S250A |
| SMF300A00S300A | SMF350A00S350A | SMF400A00S400A | SMF440A00S440A | |

MORE ITEMS AVAILABLE- Bidirectional Type

| | | | | |
|-----------------------|----------------|----------------|----------------|----------------|
| SMF050CAS050CA | SMF060CAS060CA | SMF065CAS065CA | SMF070CAS070CA | SMF075CAS075CA |
| SMF080CA0S080CA | SMF085CAS085CA | SMF090CAS090CA | SMF10CA00S10CA | SMF11CA00S11CA |
| SMF12CA00S12CA | SMF13CA00S13CA | SMF14CA00S14CA | SMF15CA00S15CA | SMF16CA00S16CA |
| SMF17CA00S17CA | SMF18CA00S18CA | SMF20CA00S20CA | SMF22CA00S22CA | SMF24CA00S24CA |
| SMF26CA00S26CA | SMF28CA00S28CA | SMF30CA00S30CA | SMF33CA00S33CA | SMF36CA00S36CA |
| SMF40CA00S40CA | SMF43CA00S43CA | SMF45CA00S45CA | SMF48CA00S48CA | SMF51CA00S51CA |
| SMF54CA00S54CA | SMF58CA00S58CA | SMF60CA00S60CA | SMF64CA00S64CA | SMF70CA00S70CA |
| SMF75CA00S75CA | SMF78CA00S78CA | SMF85CA00S85CA | SMF90CA00S90CA | SMF100CAS100CA |
| SMF110CAS110CA | SMF120CAS120CA | SMF130CAS130CA | SMF150CAS150CA | SMF160CAS160CA |
| SMF170CAS170CA | SMF180CAS180CA | SMF200CAS200CA | SMF220CAS220CA | SMF250CAS250CA |
| SMF300CAS300CA | SMF350CAS350CA | SMF400CAS400CA | SMF440CAS440CA | |

SMD TRANSIENT VOLTAGE SUPPRESSORS DIODES SMF SERIES

DIMENSION (Unit: Inch/mm)

Image for reference



Marking: 5.0CA

SMF/SOD-123FL

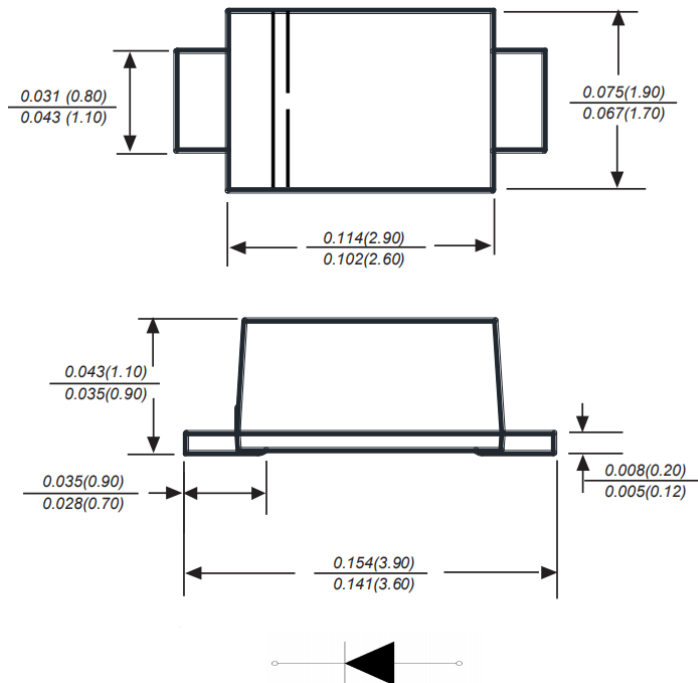

Recommend Pad Layout

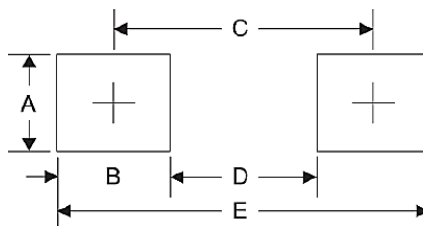

| Symbol | Unit (Inch) | Unit (mm) |
|--------|-------------|-----------|
| A | 0.047 | 1.20 |
| B | 0.047 | 1.20 |
| C | 0.126 | 3.20 |
| D | 0.079 | 2.00 |
| E | 0.173 | 4.40 |

SMD TRANSIENT VOLTAGE SUPPRESSORS DIODES SMF SERIES
MECHANICAL DATA

| Case | Terminals | Polarity | Mounting Position | Weight per piece |
|---|--|---------------------------------|-------------------|---------------------------|
| JEDEC SMF/SOD-123FL molded plastic body | Solder plated, Solderable per MIL-STD-750, Method 2026 | Polarity symbol marking on case | Any | 0.0048 Ounce, 0.015 grams |

MAX. RATING & CHARACTERISTICS - Ratings at 25°C ambient temperature unless otherwise specified.

| Parameter | SYMBOLS | VALUE | | | UNITS |
|--|--------------------|-------|---------|------|-------|
| | | Min. | Typical | Max. | |
| Peak pulse power dissipation (Note 1,2,5, Fig.1) | P _{ppm} | 200 | | | W |
| Peak Forward surge current (Note 3) | I _{FSM} | | 20 | | A |
| Peak pulse current on 10/1000µs waveform (Note 1, Fig.2) | I _{ppm} | | | 21.7 | A |
| Steady state power dissipation (Note 4) | P _{M(AV)} | | 1.0 | | W |
| Operating junction temperature range | T _J | -55 | | +150 | °C |
| Storage temperature range | T _{STG} | -55 | | +150 | °C |
| Thermal resistance junction to ambient | R _{θJA} | | 180 | | °C/W |

Note

1. Non-repetitive current pulse, per Fig 3 and derated above TA=25 °C per Fig 2
2. Mounted on 5.0*5.0mm copper pads to each terminal
3. 8.3ms single half sinewave or equivalent square wave, duty cycle=4 pulsed per minute Max.
4. Lead temperature at T_L =75 °C
5. Peak pulse power waveform is tp =10/1000µs
6. A transient suppressor is selected according to the working peak reverse voltage (V_{RWM}), which should be equal to or great than the DC or continuous peak operating voltage level.

SMD TRANSIENT VOLTAGE SUPPRESSORS DIODES SMF SERIES

ELECTRICAL CHARACTERISTICS - Ratings at 25°C

| Parameter | SYMBOLS | VALUE | UNITS |
|---|------------------|-------|-------|
| Reverse Stand-Off | V _{RWM} | 5.0 | V |
| Min. Breakdown Voltage @I _T | V _{BR} | 6.4 | V |
| Max. Breakdown Voltage @I _T | V _{BR} | 7.0 | V |
| Test Current | I _T | 10 | mA |
| Reverse Leakage @V _{RWM} | I _R | 400 | μA |
| Maximum Clamping Voltage @I _{PP} | V _C | 9.2 | V |
| Peak Pulse Current | I _{PP} | 21.7 | A |

SMD TRANSIENT VOLTAGE SUPPRESSORS DIODES SMF SERIES
RELIABILITY

| Number | Experiment Items | Experiment Method And Conditions | Reference Documents |
|--------|------------------------------------|--|---------------------------------|
| 1 | Solder Resistance Test | Test 260°C± 5°C for 10 ± 2 sec. Immerse body into solder 1/16" ± 1/32" | MIL-STD-750D METHOD-2031.2 |
| 2 | Solderability Test | 230°C ±5°C for 5 sec. | MIL-STD-750D METHOD-2026.1 0 |
| 3 | Pull Test | 1 kg in axial lead direction for 10 sec. | MIL-STD-750D METHOD-2036.4 |
| 4 | Bend Test | 0.5Kg Weight Applied To Each Lead, Bending Arcs 90 °C ± 5 °C For 3 Times | MIL-STD-750D METHOD-2036.4 |
| 5 | High Temperature Reverse Bias Test | TA=100°C for 1000 Hours at VR=80% Rated VR | MIL-STD-750D METHOD-1038.4 |
| 6 | Forward Operation Life Test | TA=25°C Rated Average Rectified Current | MIL-STD-750D METHOD-1027.3 |
| 7 | Intermittent Operation Life Test | On state: 5 min with rated IRMS Power Off state: 5 min with Cool Forced Air. On and off for 1000 cycles. | MIL-STD-750D METHOD-1036.3 |
| 8 | Pressure Cooker Test | 15 PSIG, TA=121°C, 4 hours | MIL-S-19500 APPENOIXC |
| 9 | Temperature Cycling Test | -55°C~+125°C; 30 Minutes For Dwelled Time 5 minutes for transferred time. Total: 10 cycles. | MIL-STD-750D METHOD-1051.7 |
| 10 | Thermal Shock Test | 0°C for 5 minutes., 100°C for 5minutes, Total: 10 cycles | MIL-STD-750D METHOD-1056.7 |
| 11 | Forward Surge Test | 8.3ms Single Sale Sine-wave One Surge. | MIL-STD-750D METHOD-4066.4 |
| 12 | Humidity Test | TA=65°C, RH=98% for 1000 hours. | MIL-STD-750D METHOD-1021.3 |
| 13 | High Temperature Storage life Test | 150°C for 1000 Hours | MIL-STD-750D METHOD-1031.5 |

SMD TRANSIENT VOLTAGE SUPPRESSORS DIODES SMF SERIES

SUGGESTED REFLOW PROFILE (For Reference Only)

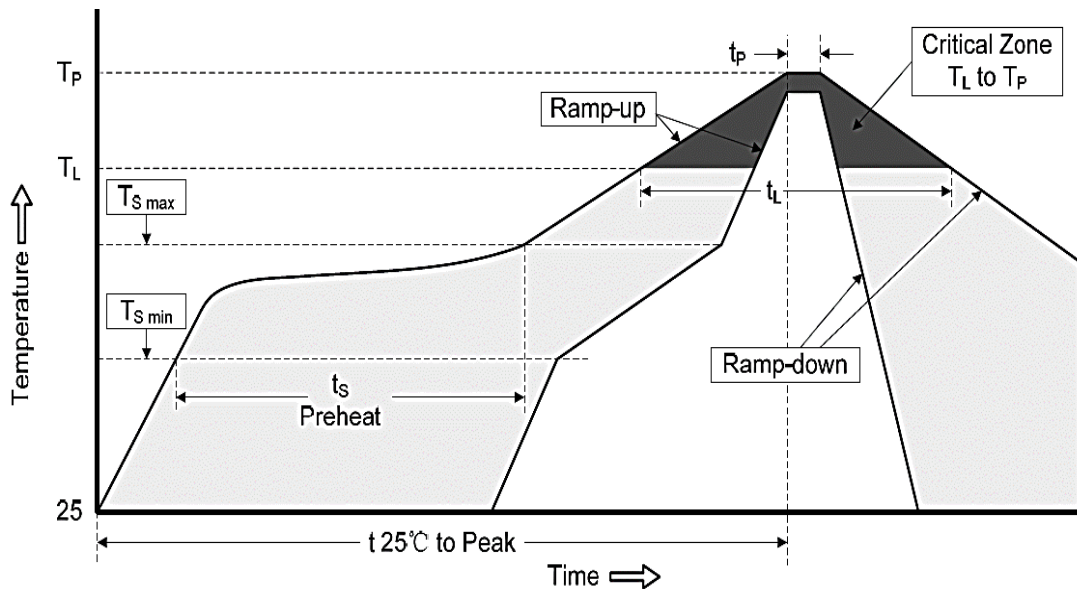

| | | |
|--|----------------------------------|-------------------|
| Profile Feature | | Pb-Free Assembly |
| Average Ramp-up Rate (Ts Max to Tp) | | 3°C/second Max |
| Preheat | Temperature Min (Ts Min.) | 150°C |
| | Temperature Max (Ts Max.) | 200°C |
| | Time (ts Min. to ts Max.) | 60 ~ 180 seconds |
| Time maintained above | Temperature (Tl) | 217°C |
| | Time (tL) | 60 ~ 150 seconds |
| Peak/Classification Temperature (Tp) | | 260 °C |
| Time within 5°C of actual Peak Temperature (tp) | | 20 ~ 40 seconds |
| Ramp-down rate | | 6 °C /Second Max. |
| Time 25 °C to Peak Temperature | | 8 minutes Max. |
| Suggest reflow times | | 3 Times Max. |

SMD TRANSIENT VOLTAGE SUPPRESSORS DIODES SMF SERIES

RATINGS AND CHARACTERISTIC CURVES (For Reference Only)

Fig.1 Peak Pulse Power Rating Curve

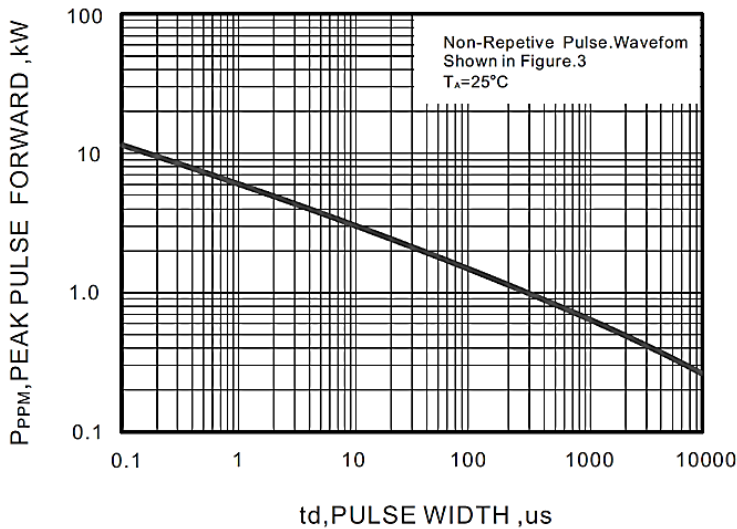
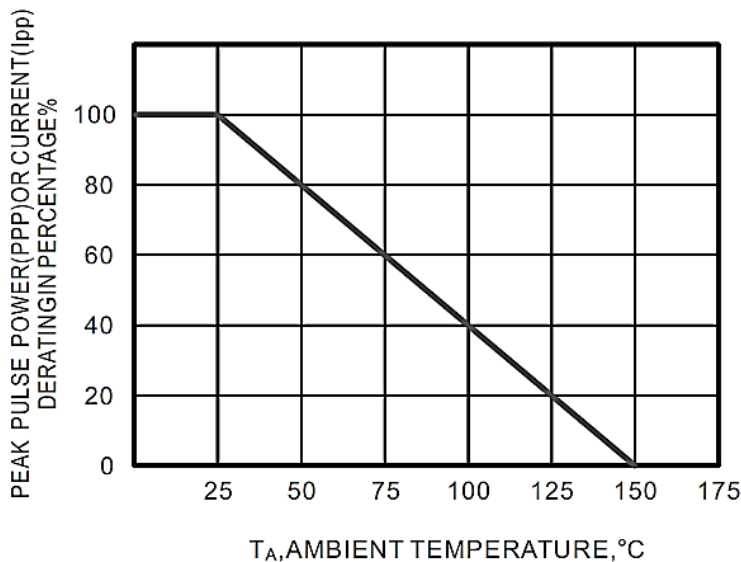

Fig.2 Forward Current Derating Curve



SMD TRANSIENT VOLTAGE SUPPRESSORS DIODES SMF SERIES

RATINGS AND CHARACTERISTIC CURVES (For Reference Only)

Fig.3 Pulse Waveform

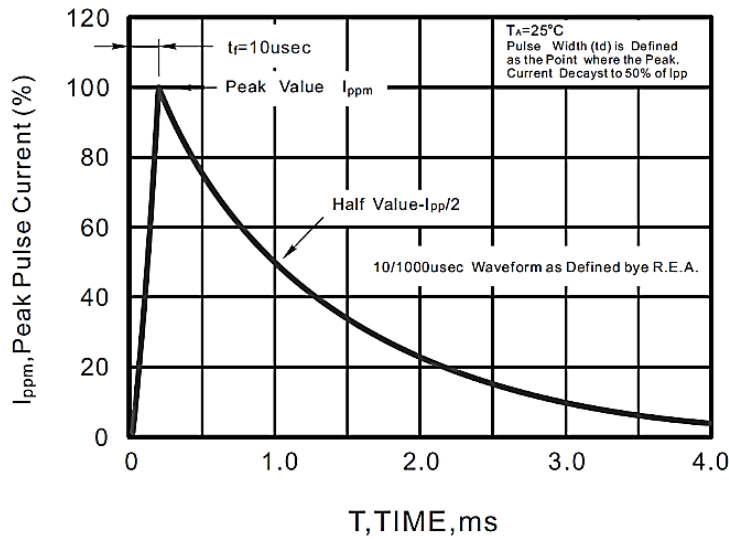
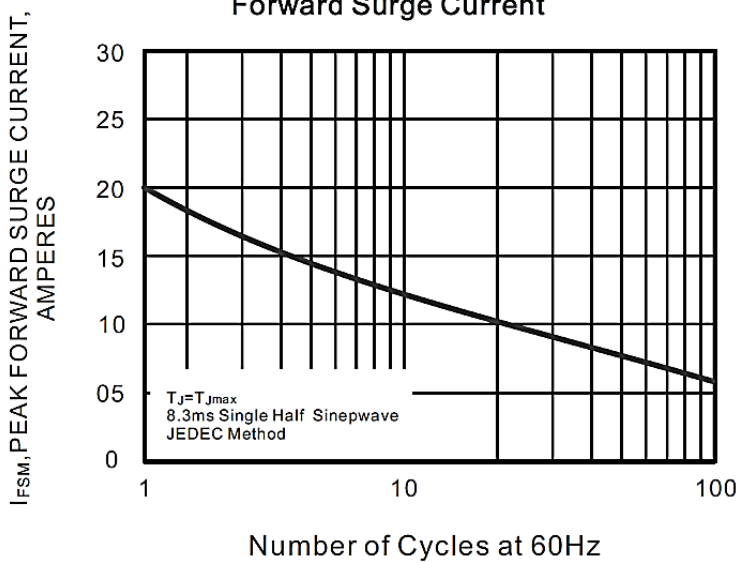

Fig.4 Maximum Non-Repetitive Peak Forward Surge Current



SMD TRANSIENT VOLTAGE SUPPRESSORS DIODES SMF SERIES

TAPE/REEL (Unit: mm)

All Devices are packed in accordance with EIA standard RS-481-A and specifications.

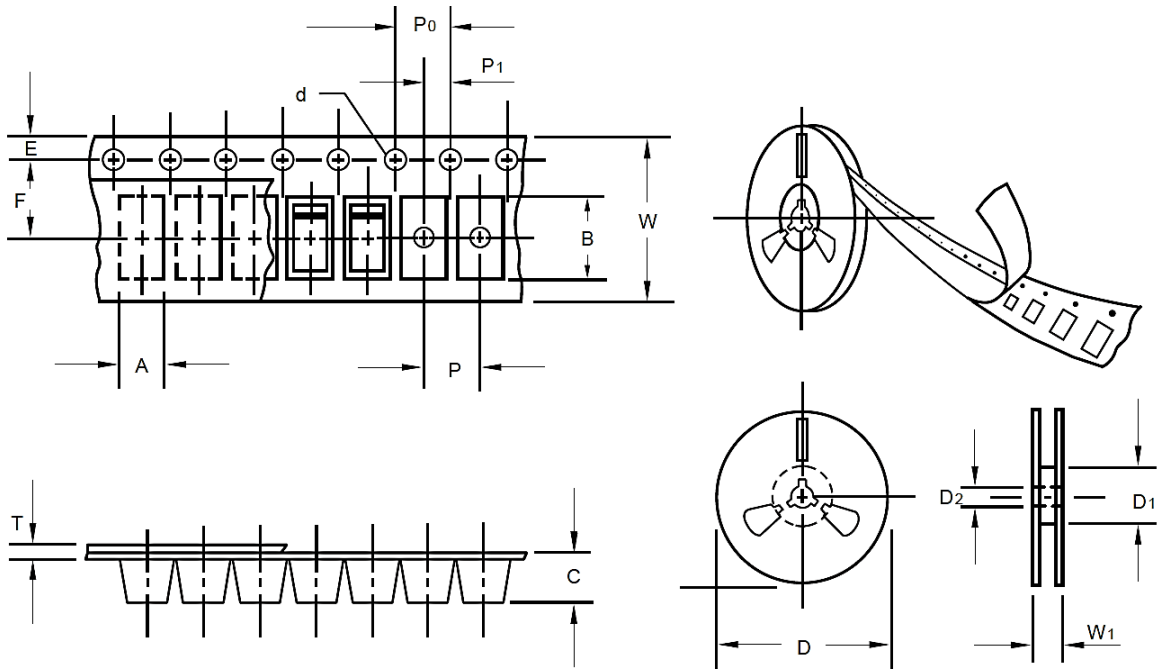

| Item | Symbol | Tolerance | SMF/SOD-123FL |
|-------------------------|--------|-----------|---------------|
| Carrier width | A | 0.1 | 2.10 |
| Carrier Length | B | 0.1 | 4.00 |
| Carrier Depth | C | 0.1 | 1.60 |
| Sprocket hole | d | 0.05 | 1.55 |
| 7"Reel outside diameter | D | 2.0 | 178.00 |
| 7"Reel inner diameter | D1 | Min. | 50.00 |
| Feed hole diameter | D2 | 0.5 | 13.00 |
| Sprocket hole position | E | 0.1 | 1.75 |
| Punch hole position | F | 0.1 | 3.50 |
| Punch hole pitch | P | 0.1 | 4.00 |
| Sprocket hole pitch | P0 | 0.1 | 4.00 |
| Embossment center | P1 | 0.1 | 2.00 |
| Overall tape thickness | T | 0.1 | 0.25 |
| Tape width | W | 0.3 | 8.15 |
| Reel width | W1 | 1.0 | 10.50 |

SMD TRANSIENT VOLTAGE SUPPRESSORS DIODES SMF SERIES

PACKAGE For Reference

| | |
|------------------|-----------|
| Case Code | SOD-123FL |
| Reel Size | 7" |
| Reel Size | 178 mm |
| MPQ/Reel | 3000 pcs |
| Qty. /Box | 6000 pcs |
| G.W/Box | 1 lbs |

IMPORTANT NOTICE AND DISCLAIMER

- 1) NextGen Component, Inc. reserves the right to make changes to this document and its products and specifications at any time without notice. Customers should obtain and confirm the latest product information and specifications before final design, purchase or use.
- 2) NextGen Component, Inc makes no warranty, representation or guarantee regarding the suitability of its products for any particular purpose, nor does NextGen Component, Inc assume any liability for application assistance or customer product design.
- 3) NextGen Component, Inc does not warrant or accept any liability with products which are purchased or used for any unintended or unauthorized application. No license is granted by implication or otherwise under any intellectual property rights of NextGen Component, Inc
- 4) NextGen Component, Inc. products are not authorized for use as critical components in life support devices or systems without express written approval of NextGen Component, Inc.