



SPECIFICATION SHEET

SPECIFICATION SHEET NO.	N1230- SMBSS240000S24
DATE	Dec.30, 2021
REVISION	A0
DESCRIPTION	SMD Schottky Barrier Rectifier, 2 Pads, SMB series, SS24B Type Reverse Voltage 40V Max. Forward Current 2.0A Max. Operating Temp. Range -55°C ~+125°C, Package in Tape/Reel, 3000pcs/Reel RoHS/RoHS III compliant
CUSTOMER	
CUSTOMER PART NUMBER	
CROSS REF. PART NUMBER	
ORIGINAL PART NUMBER	MDD SS24B
PART CODE	SMBSS240000S24

VENDOR APPROVE			
Issued/Checked/Approved			
DATE: Dec.30, 2021			

CUSTOMER APPROVE	
DATE:	

1/8/2022

SMD SCHOTTKY BARRIER RECTIFIER SMB SERIES



MAIN FEATURE

- The plastic package carries Underwriters Laboratory Flammability Classification 94V-0
- Low reverse leakage
- Built-in strain relief
- Low power loss, high efficiency
- High forward surge current capability
- High temperature soldering guaranteed: 250°C/ 10 seconds at terminals
- Metal silicon junction, majority carrier conduction

APPLICATION

- For surface mounted applications

RFQ

[Request For Quotation](#)

PART CODE GUIDE

SMB	SS240000	S	24
1	2	3	4

- 1) **SMB**: SMD Schottky Barrier Rectifier, 2 Pads, Package SMB series
- 2) **SS240000**: Type code for original part number SS24B
- 3) **S**: Package code, Tape/reel, 3000pcs/reel.
- 4) **24**: Specification code for Reverse Voltage 40V Max. Forward Current 2.0A Max.

SMD SCHOTTKY BARRIER RECTIFIER SMB SERIES

DIMENSION (Unit: Inch/mm)

Image for reference



Marking: SS24B

SMB/DO-214AA

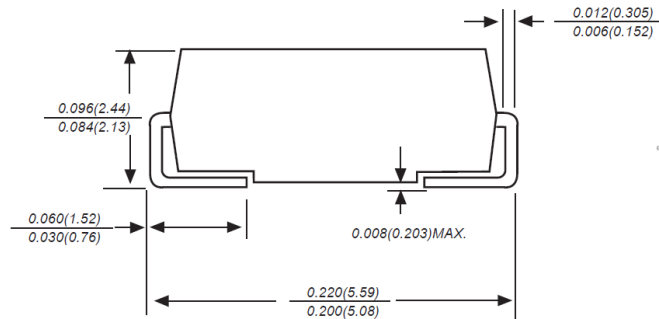
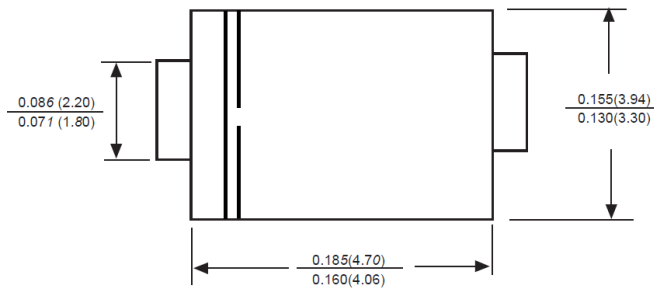

Recommend Pad Layout

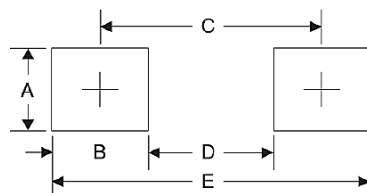

Symbol	Unit (inch)	Unit (mm)
A	0.110	2.80
B	0.094	2.40
C	0.181	4.60
D	0.086	2.20
E	0.276	7.00

SMD SCHOTTKY BARRIER RECTIFIER SMB SERIES
MECHANICAL DATA

Case	Terminals	Polarity	Mounting Position	Weight per piece
JEDEC SMB/DO-214AA molded plastic body	Solder plated, Solderable per MIL-STD-750, Method 2026	Polarity symbol marking on case	Any	0.0030 Ounce, 0.0850 grams

MAX. RATING & CHARACTERISTICS

Parameter	SYMBOLS	VALUE			UNITS
		Min.	Typical	Max.	
Repetitive peak reverse voltage	V _{RRM}			40	Volts
RMS voltage	V _{RMS}			28	Volts
DC blocking voltage	V _{DC}			40	Volts
Average forward output rectified current at TL (see fig.1)	I _{AV}			2.0	A
Peak forward surge current 8.3ms single half sine-wave superimposed on rated load (JEDEC Method)	I _{FSM}		55		A
Instantaneous forward voltage at 2.0A	V _F			0.55	Volts
DC reverse current at rated DC blocking voltage	I _R			0.5	mA
				10	mA
Junction capacitance (NOTE 2)	C _J		220		pF
Thermal resistance (Note 3)	R _{QJA}		75.0		°C/W
Operating junction temperature range	T _J	-55		+125	°C
Storage temperature range	T _{STG}	-55		+150	°C

Note

- Ratings at 25 C ambient temperature unless otherwise specified. Single phase half-wave 60Hz, resistive or inductive load, for capacitive load current derate by 20%.
- Measured at 1.0MHz and applied reverse voltage of 4.0Voltage
- P.C.B. mounted with 0.2x0.2"(5.0x5.0mm) copper pad areas.

SMD SCHOTTKY BARRIER RECTIFIER SMB SERIES
RELIABILITY

Number	Experiment Items	Experiment Method And Conditions	Reference Documents
1	Solder Resistance Test	Test 250°C± 5°C for 10 ± 2 sec. Immerse body into solder 1/16" ± 1/32"	MIL-STD-750D METHOD-2031.2
2	Solderability Test	230°C ±5°C for 5 sec.	MIL-STD-750D METHOD-2026.1 0
3	Pull Test	1 kg in axial lead direction for 10 sec.	MIL-STD-750D METHOD-2036.4
4	Bend Test	0.5Kg Weight Applied To Each Lead, Bending Arcs 90 °C ± 5 °C For 3 Times	MIL-STD-750D METHOD-2036.4
5	High Temperature Reverse Bias Test	TA=100°C for 1000 Hours at VR=80% Rated VR	MIL-STD-750D METHOD-1038.4
6	Forward Operation Life Test	TA=25°C Rated Average Rectified Current	MIL-STD-750D METHOD-1027.3
7	Intermittent Operation Life Test	On state: 5 min with rated IRMS Power Off state: 5 min with Cool Forced Air. On and off for 1000 cycles.	MIL-STD-750D METHOD-1036.3
8	Pressure Cooker Test	15 PSIG, TA=121°C, 4 hours	MIL-S-19500 APPENOIXC
9	Temperature Cycling Test	-55°C~+125°C; 30 Minutes For Dwelled Time 5 minutes for transferred time. Total: 10 cycles.	MIL-STD-750D METHOD-1051.7
10	Thermal Shock Test	0°C for 5 minutes., 100°C for 5minutes, Total: 10 cycles	MIL-STD-750D METHOD-1056.7
11	Forward Surge Test	8.3ms Single Sale Sine-wave One Surge.	MIL-STD-750D METHOD-4066.4
12	Humidity Test	TA=65°C, RH=98% for 1000 hours.	MIL-STD-750D METHOD-1021.3
13	High Temperature Storage life Test	150°C for 1000 Hours	MIL-STD-750D METHOD-1031.5

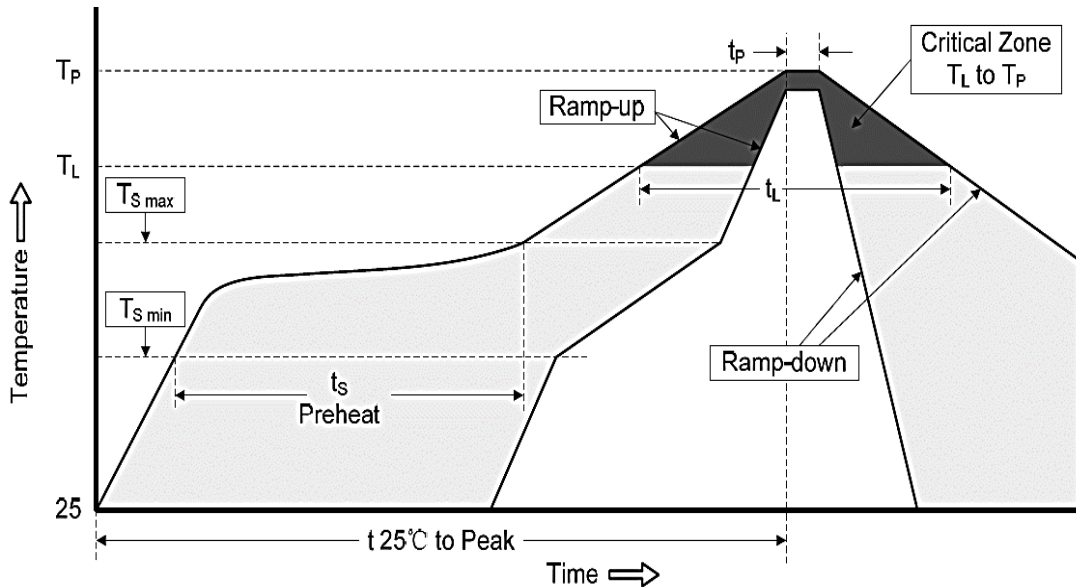
SMD SCHOTTKY BARRIER RECTIFIER SMB SERIES
SUGGESTED REFLOW PROFILE (For Reference Only)

Profile Feature		Pb-Free Assembly
Average Ramp-up Rate (Ts Max to Tp)		3°C/second Max
Preheat	Temperature Min (Ts Min.)	150°C
	Temperature Max (Ts Max.)	200°C
	Time (ts Min. to ts Max.)	60 ~ 180 seconds
Time maintained above	Temperature (Tl)	217°C
	Time (tl)	60 ~ 150 seconds
Peak/Classification Temperature (Tp)		250 °C
Time within 5°C of actual Peak Temperature (tp)		10 seconds
Ramp-down rate		6 °C /Second Max.
Time 25 °C to Peak Temperature		6 minutes Max.
Suggest reflow times		3 Times Max.

SMD SCHOTTKY BARRIER RECTIFIER SMB SERIES

RATINGS AND CHARACTERISTIC CURVES (For Reference Only)

Fig.1 Forward Current Derating Curve

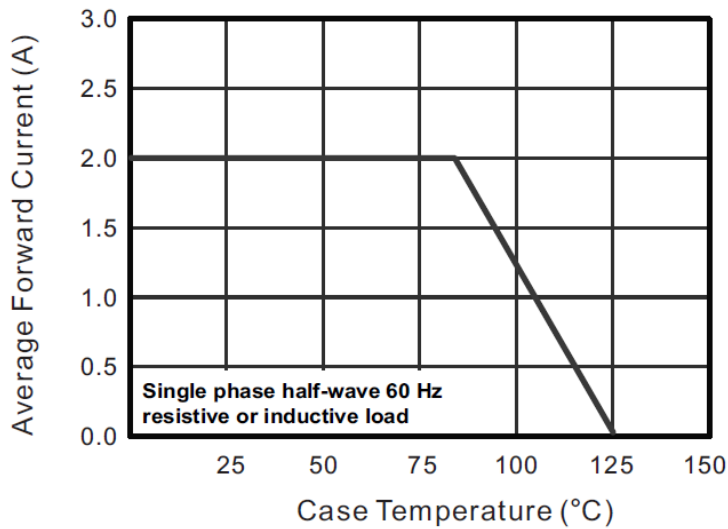
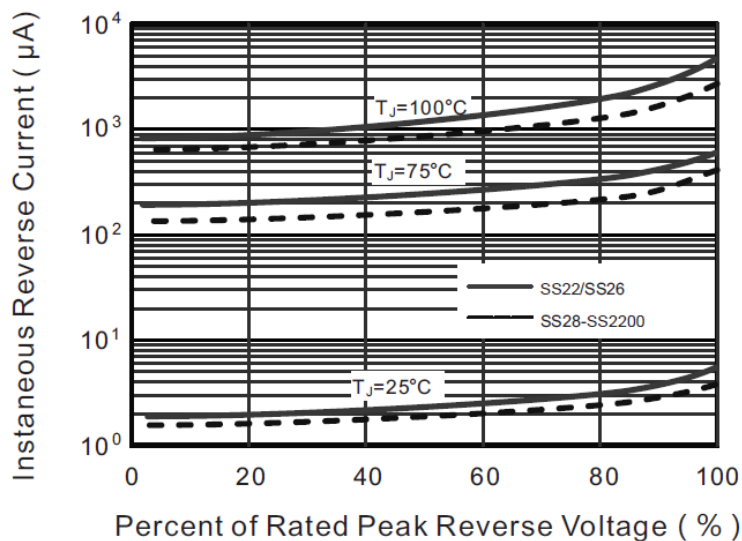

Fig.2 Typical Reverse Characteristics



SMD SCHOTTKY BARRIER RECTIFIER SMB SERIES

RATINGS AND CHARACTERISTIC CURVES (For Reference Only)

Fig.3 Typical Forward Characteristic

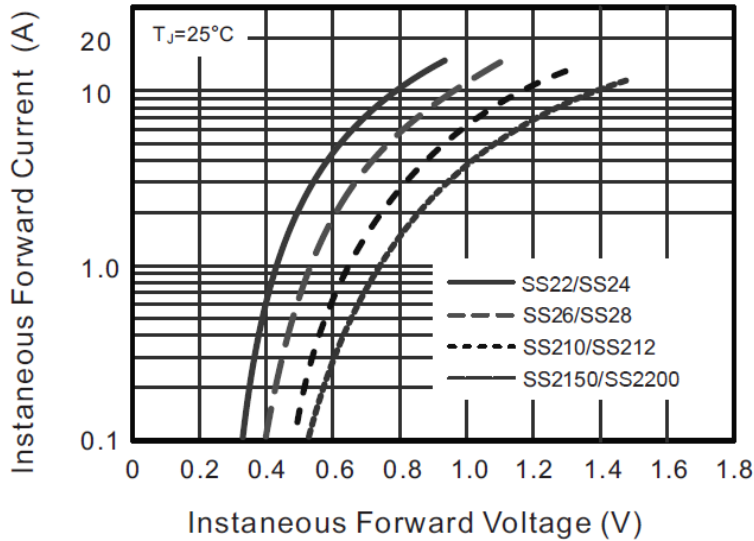
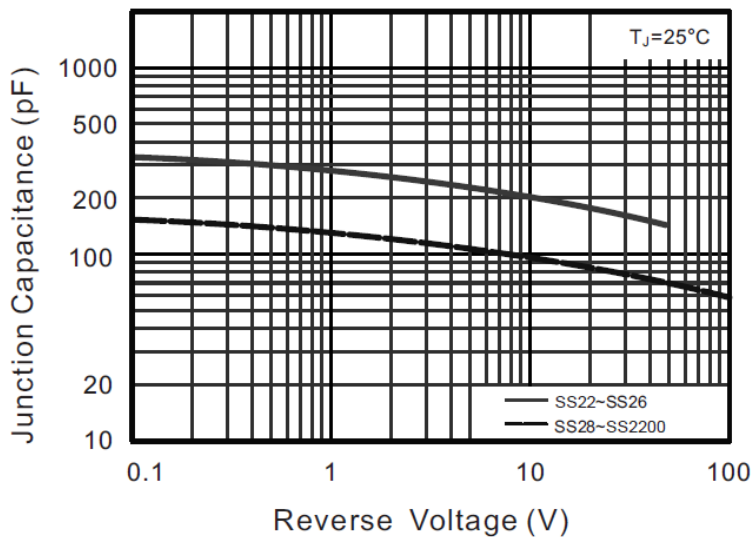

Fig.4 Typical Junction Capacitance



SMD SCHOTTKY BARRIER RECTIFIER SMB SERIES

RATINGS AND CHARACTERISTIC CURVES (For Reference Only)

Fig.5 Maximum Non-Repetitive Peak Forward Surge Current

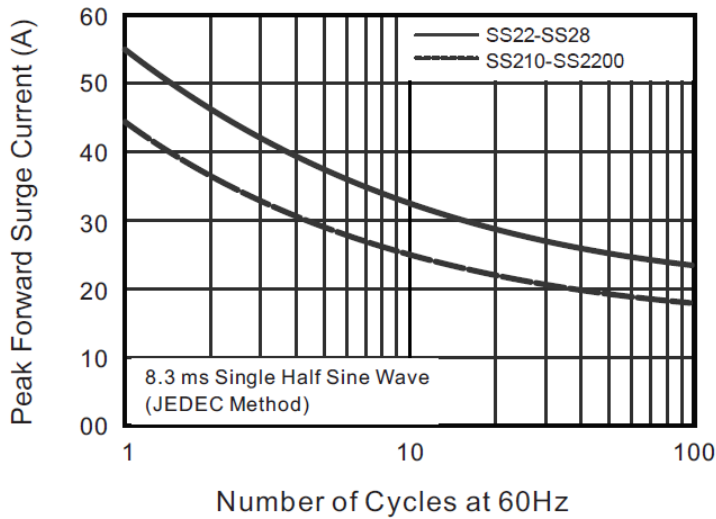
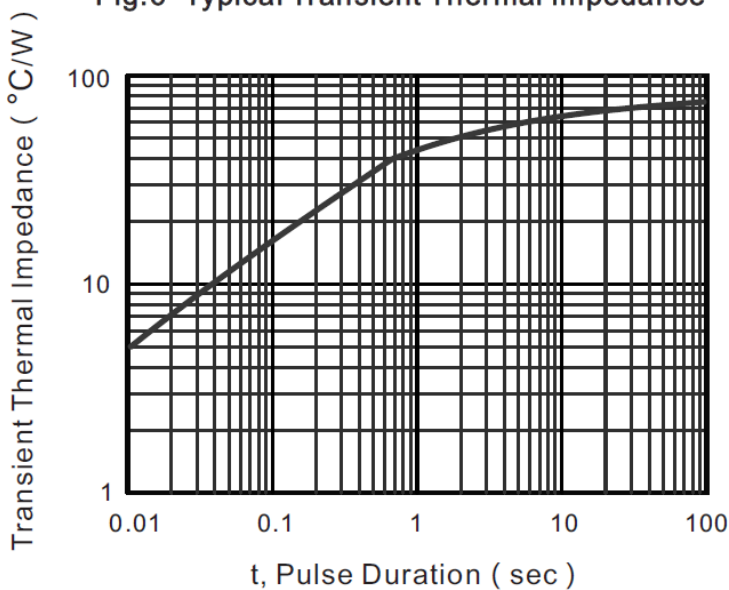

Fig.6- Typical Transient Thermal Impedance



SMD SCHOTTKY BARRIER RECTIFIER SMB SERIES

TAPE/REEL (Unit: mm)

All Devices are packed in accordance with EIA standard RS-481-A and specifications.

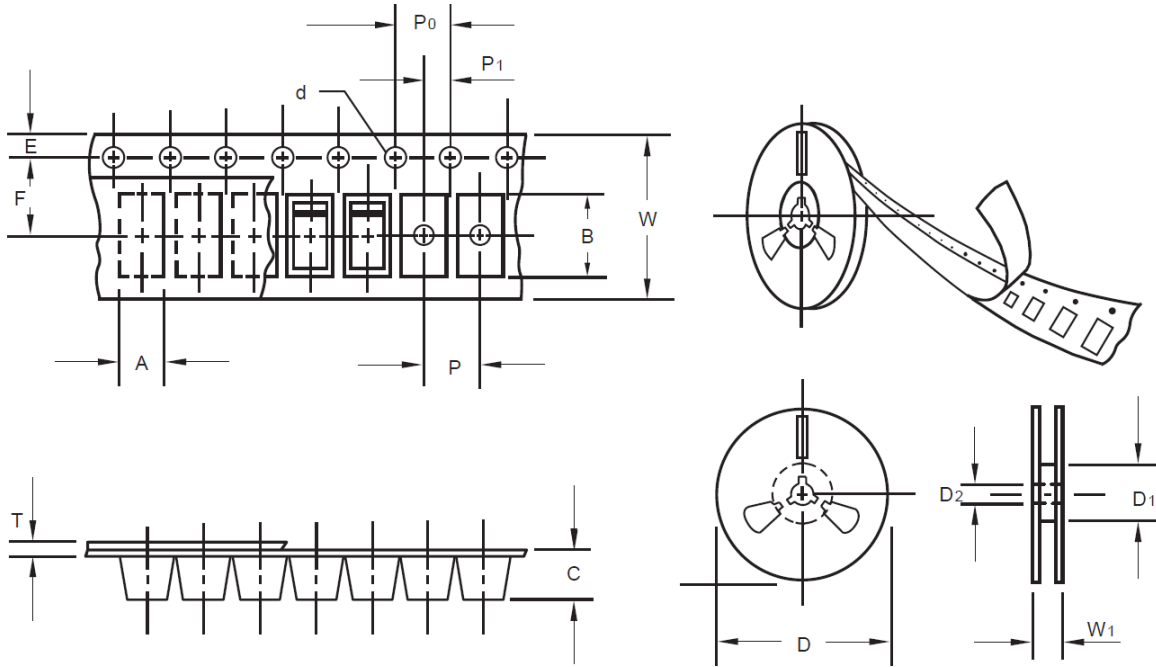

Item	Symbol	Tolerance	SMB/DO-214AA
Carrier width	A	0.1	3.81
Carrier Length	B	0.1	5.41
Carrier Depth	C	0.1	2.42
Sprocket hole	d	0.05	1.50
13" Reel outside diameter	D	2.0	330.00
13" Reel inner diameter	D1	Min.	50.00
7" Reel outside diameter	-	-	-
7" Reel inner diameter	-	-	-
Feed hole diameter	D2	0.5	13.00
Sprocket hole position	E	0.1	1.75
Punch hole position	F	0.1	5.55
Punch hole pitch	P	0.1	8.00
Sprocket hole pitch	P0	0.1	4.00
Embossment center	P1	0.1	2.00
Overall tape thickness	T	0.1	0.30
Tape width	W	0.3	12.00
Reel width	W1	1.0	12.30

SMD SCHOTTKY BARRIER RECTIFIER SMB SERIES

PACKAGE For Reference

Case Code	SMB
Reel Size	13"
Reel Size	330 mm
MPQ/Reel	3000 pcs
Qty. /Box	6000 pcs
G.W/Box	6 lbs

DISCLAIMER

NextGen Component, Inc. reserves the right to make changes to the product(s) and or information contained herein without notice. No liability is assumed as a result of their use or application. No rights under any patent accompany the sale of any such product(s) or information