

DATA SHEET

# SKY65364-11: 900 MHz Transmit/Receive Front-End Module

## Applications

- Automated meter reading
- Advanced metering infrastructure
- ISM systems

## Features

- Transmit output power > +30.5 dBm
- High efficiency PA
- Analog power control
- Receive path NF <2.1 dB
- PA bypass mode
- LNA low current mode with external resistor
- LNA bypass mode
- Integrated control logic
- Internal RF match and bias circuits
- All RF ports internally DC blocked
- Shutdown mode
- Small footprint, MCM (28-pin, 6 x 6 mm) package (MSL3, 260 °C per JEDEC J-STD-020)



Skyworks Green™ products are compliant with all applicable legislation and are halogen-free. For additional information, refer to *Skyworks Definition of Green™*, document number SQ04-0074.

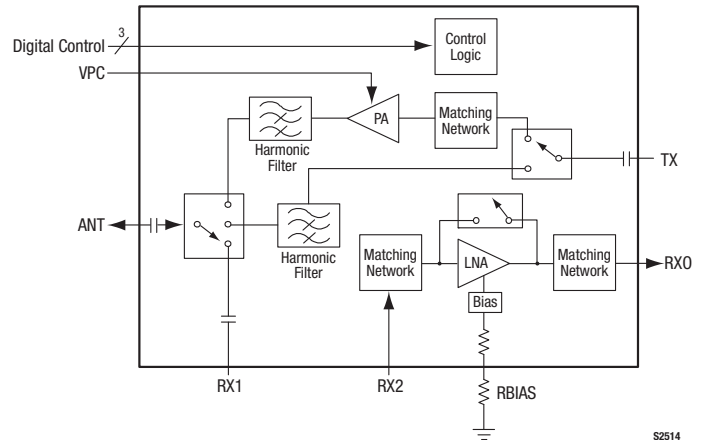


Figure 1. SKY65364-11 Block Diagram

## Description

The Skyworks SKY65364-11 is a high-performance, transmit/receive (T/R) front-end module (FEM). The device provides a complete T/R chain with T/R switches.

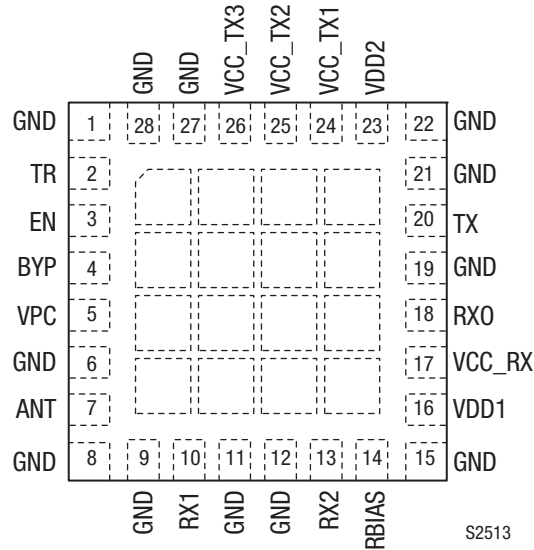
The device transmit chain features +30.5 dBm output power and a 40 percent power-added efficiency (PAE).

The device receive chain features a low-noise amplifier (LNA) with a 1.7 dB noise figure (NF) and 16.0 dB gain. The cascaded NF and gain, taking into account the 0.5 dB insertion loss transmit/receive antenna switch, are 2.2 dB and 15.5 dB, respectively, which makes the SKY65364-11 ideal for medium power microwave links such as 900 MHz Industrial, Scientific, and Medical (ISM) band applications.

The module also has a shut-down mode, PA bypass mode, and LNA bypass mode to minimize power consumption.

The device is mounted in a 28-pin, 6 x 6 mm Multi-Chip Module (MCM) surface-mount technology (SMT) package, which allows for a highly manufacturable low-cost solution.

A block diagram of the SKY65364-11 is shown in Figure 1. The device package and pinout for the 28-pin MCM are shown in Figure 2. Signal pin assignments and functional pin descriptions are provided in Table 1.



**Figure 2. SKY65364-11 Pinout (Top View)**

**Table 1. SKY65364-11 Signal Descriptions**

Pin	Name	Description	Pin	Name	Description
1	GND	Ground	15	GND	Ground
2	TR	Digital control input: transmit/receive mode	16	VDD1	3.3 V power supply
3	EN	Digital control input: shutdown mode	17	VCC_RX	3.3 V power supply
4	BYP	Digital control input: receive bypass mode	18	RX0	Receive output
5	VPC	Transmit output power adjustment	19	GND	Ground
6	GND	Ground	20	TX	Transmit path input port. Internally matched to 50 Ω.
7	ANT	Antenna switch common port. Internally matched to 50 Ω.	21	GND	Ground
8	GND	Ground	22	GND	Ground
9	GND	Ground	23	VDD2	3.6 V power supply
10	RX1	Receive arm of antenna switch. Internally matched to 50 Ω.	24	VCC_TX1	3.6 V power supply
11	GND	Ground	25	VCC_TX2	3.6 V power supply
12	GND	Ground	26	VCC_TX3	3.6 V power supply
13	RX2	LNA and bypass switch output port. Internally matched to 50 Ω.	27	GND	Ground
14	RBIAS	LNA bias setting resistor	28	GND	Ground

### Technical Description

The SKY65364-11 consists of a complete T/R chain with T/R switches contained in the module. A single-pole triple-throw (SP3T) switch selects between the receive, transmit, and transmit bypass paths. The module has a shut-down mode to minimize power consumption.

Three digital input pins (EN, TR, and BYP) are used to select between transmit, transmit bypass, receive, receive bypass, or shutdown mode.

### Transmit Path

The transmit path contains a Power Amplifier (PA) optimized for saturated performance. The PA output is internally matched for optimum output power and efficiency into a 50 Ω load impedance. The PA output is passed through an harmonic filter before being fed through the SP3T switch. The PA input provides a good return loss into a 50 Ω source impedance.

Transmit output power is controlled by the VPC pin, which is normally set to 2.25 V DC voltage. The nominal DC input impedance into the VPC pin is 50 kΩ.

### Receive Path

The receive path contains an LNA with bypass switch. The LNA impedance matching networks are internal to the module and have been optimized for a low NF while maintaining good return losses into a 50 Ω source and load impedance. The receive arm of the SP3T switch and the LNA input are connected to module pins to allow an external filter to be inserted into the receive path.

LNA biasing can be independently lowered with an external bias resistor between the RBIAS pin and ground.

### Operation Mode Control

The five SKY65364-11 operating modes are controlled by the three digital pins TR, EN, and BYP (pins 2, 3, and 4, respectively). The control logic truth table is provided in Table 2.

**Table 2. SKY65364-11 Operating Modes Truth Table<sup>1</sup>**

Operating Mode	Control Voltage			Internal States				
	TR (Pin 2)	EN (Pin 3)	BYP (Pin 4)	PA	LNA	LNA Bypass Switch	T/R Switch	PA Bypass Switch
Transmit	1	1	0	On	Off	Open	PA	PA
Transmit bypass	1	1	1	Off	Off	Open	PA bypass	PA bypass
Receive	0	1	0	Off	On	Open	RX1	Open
Receive Bypass	0	1	1	Off	Off	Through	RX1	Open
Shutdown (Note 2)	X	0	X	Off	Off	Open	Open	Open

<sup>1</sup> See Recommended Operating Conditions Table for logic 0 and 1 characteristics. "X" = don't care state, defined as a valid state of logic 1 or 0.

<sup>2</sup> In the high state, EN, TR, and BYP have an input current of 33 μA due to an internal 100 kΩ pulldown resistance. For the lowest leakage current, the high state is not recommended for TR and BYP when the device is in shutdown mode (EN = 0).

### Electrical and Mechanical Specifications

The absolute maximum ratings of the SKY65364-11 are provided in Table 3. Recommended operating conditions are specified in

Table 4. Electrical specifications are provided in Tables 5, 6, and 7. Typical performance characteristics of the SKY65364-11 are illustrated in Figures 3 through 17.

**Table 3. SKY65364-11 Absolute Maximum Ratings<sup>1</sup>**

Parameter	Symbol	Minimum	Maximum	Units
LNA supply voltage	VCC_RX	-0.3	+5.0	V
LNA supply current	I <sub>CC_RX</sub>		20	mA
PA supply voltage	VCC_TX1/2/3	-0.3	+6.0	V
PA supply current	I <sub>CC_TX</sub>		1.6	A
Digital supply voltage	V <sub>DD1</sub>	-0.5	+5.5	V
Digital supply voltage	V <sub>DD2</sub>	-0.5	+5.5	V
Digital control voltage (EN, TR, BYP)	V <sub>CTL</sub>	-0.5	V <sub>DD1</sub> + 0.3	V
Transmit output power control voltage	VPC	-0.3	+5.0	V
Receive RF input power (RX2)	P <sub>IN_RX2</sub>		+5	dBm
Receive RF input power (ANT)	P <sub>IN_ANT</sub>		+33	dBm
Transmit RF input power	P <sub>IN_TX</sub>		+15	dBm
Transmit RF input power, bypass mode	P <sub>IN_TX_BYP</sub>		+20	dBm
Operating case temperature <sup>2</sup>	T <sub>C</sub>	-40	+85	°C
Storage temperature	T <sub>STG</sub>	-55	+150	°C
Junction temperature	T <sub>J</sub>		+150	°C
T/R port load VSWR in transmit mode	VSWR		10:1	-

<sup>1</sup> Exposure to maximum rating conditions for extended periods may reduce device reliability. There is no damage to device with only one parameter set at the limit and all other parameters set at or below their nominal value.

<sup>2</sup> Nominal thermal resistance, junction to case, is 18 °C/W.

**ESD HANDLING:** *Although this device is designed to be as robust as possible, electrostatic discharge (ESD) can damage this device. This device must be protected at all times from ESD when handling or transporting. Static charges may easily produce potentials of several kilovolts on the human body or equipment, which can discharge without detection. Industry-standard ESD handling precautions should be used at all times.*

**Table 4. SKY65364-11 Recommended Operating Conditions**

Parameter	Symbol	Min	Typ	Max	Units
Transmit frequency range	f	890		960	MHz
Receive frequency range	f	900		960	MHz
LNA supply voltage	VCC_RX	3.00	3.30	3.45	V
Digital supply voltage	VDD1	3.00	VCC_RX	3.45	V
	VDD2	3.40	VCC_TX1/2/3	3.80	V
PA supply voltage	VCC_TX1/2/3	3.40	3.60	3.80	V
Digital input voltage, logic 1 (EN, TR, BYP)	V <sub>IH</sub>	1.6		VDD1	V
Digital input voltage, logic 0 (EN, TR, BYP)	V <sub>IL</sub>	0		0.7	V
Transmit output power control voltage	VPC	0	2.25	2.50	V
Receive RF input power (RX2)	P <sub>IN_RX2</sub>			-15	dBm
Transmit RF input power (TX)	P <sub>IN_TX</sub>		+10	+13	dBm

**Table 5. SKY65364-11 DC Electrical Specifications<sup>1</sup>**

**(VCC\_RX = VDD1 = 3.0 V to 3.45 V, VCC\_TX1/2/3 = VDD2 = 3.4 V to 3.8 V, Tc = -40 °C to +85 °C, RBIAS = 0 Ω, No RF Input Power, Unless Otherwise Noted)**

Parameter	Symbol	Test Condition	Min	Typ	Max	Units
Quiescent current, receive mode <sup>2</sup>	I <sub>Q_RX</sub>				20	mA
Quiescent current, receive low current mode <sup>2,3</sup>	I <sub>Q_RX_LC</sub>	RBIAS = 3.8 kΩ		5		mA
Quiescent current, receive bypass mode <sup>2</sup>	I <sub>Q_BYP</sub>			34	76	μA
VDD1 quiescent current, transmit mode	I <sub>Q_VDD1</sub>			25	30	mA
VCC_TX1/2/3 quiescent current, transmit mode	I <sub>Q_TX</sub>	T <sub>C</sub> = 25 °C, VCC_TX1/2/3 = 3.6 V, VCC_RX = 3.3 V		55		mA
VCC_TX1/2/3 operating current, transmit mode	I <sub>OP_TX</sub>	P <sub>IN</sub> = +10 dBm		730	880	mA
VDD1 quiescent current, transmit bypass mode <sup>3</sup>	I <sub>DD1</sub>			10		μA
VCC_TX1/2/3 quiescent current, transmit bypass mode <sup>3</sup>	I <sub>Q_TXB</sub>			0.030		μA
VCC_RX quiescent current, shutdown mode <sup>3</sup>	I <sub>Q_SD_RX</sub>			0.025		μA
VCC_TX1/2/3 quiescent current, shutdown mode <sup>3</sup>	I <sub>Q_SD_TX</sub>			0.030		μA
Digital input current, logic 1 <sup>3</sup>	I <sub>IH</sub>			33		μA
Digital input current, logic 0 <sup>3</sup>	I <sub>IL</sub>			0		μA

<sup>1</sup> Performance is guaranteed only under the conditions listed in this table. Modes are established as indicated in Table 2.

<sup>2</sup> Total current drawn from VCC\_RX and VDD1 supplies.

<sup>3</sup> Not production tested.

**Table 6. SKY65364-11 Electrical Specifications: Receive and Receive Bypass Mode<sup>1</sup> (1 of 2)**

**(VCC\_RX = VDD1 = 3.0 V to 3.45 V, VCC\_TX1/2/3 = VDD2 = 3.4 V to 3.8 V, Tc = -40 °C to +85 °C, f = 900 to 960 MHz, 50 Ω Source and Load Impedance, CW Input, RBIAS = 0 Ω, Unless Otherwise Noted)**

Parameter	Symbol	Test Condition	Min	Typ	Max	Units
<b>Receive Mode: RX2 to Receive Output Path</b>						
Small signal gain	G		13.5	16.5		dB
Noise figure	NF	T <sub>C</sub> = 25 °C, VCC_RX = 3.3 V		1.7	2.1	dB
Noise figure variation over temperature	NF <sub>TEMP</sub>			±0.15		dB
1 dB input compression point	IP1dB	1 dB gain compression	-16.5	-11.5		dBm
Third order input intercept point	IIP3	P <sub>IN</sub> = -30 dBm/tone, 200 kHz spacing	-5.0	-1.7		dBm
Input return loss	S <sub>11</sub>		8			dB
Output return loss	S <sub>22</sub>		8			dB
Reverse isolation	S <sub>12</sub>		16	22		dB
Non-harmonic spurious <sup>2,3</sup>	P <sub>SPUR</sub>	VSWR 10:1, all phases			-50	dBm
Transition time <sup>2</sup>	t			0.5		μs

**Table 6. SKY65364-11 Electrical Specifications: Receive and Receive Bypass Mode<sup>1</sup> (2 of 2)**  
**(VCC\_RX = VDD1 = 3.0 V to 3.45 V, VCC\_TX1/2/3 = VDD2 = 3.4 V to 3.8 V, Tc = -40 °C to +85 °C, f = 900 to 960 MHz, 50 Ω Source and Load Impedance, CW Input, RBIAS = 0 Ω, Unless Otherwise Noted)**

Parameter	Symbol	Test Condition	Min	Typ	Max	Units
<b>Receive Low Current Mode<sup>2</sup></b>						
Small signal gain	G	RBIAS = 3.8 kΩ		15		dB
Noise figure	NF	Tc = 25 °C, VCC_RX = 3.3 V, RBIAS = 3.8 kΩ		1.7		dB
1 dB input compression point	IP1dB	1 dB gain compression, RBIAS = 3.8 kΩ		-23		dBm
Third order input intercept point	IIP3	PIN = -30 dBm/tone, 200 kHz spacing, RBIAS = 3.8 kΩ		-13.5		dBm
Input return loss	IS11	RBIAS = 3.8 kΩ	8			dB
Output return loss	IS22	RBIAS = 3.8 kΩ	8			dB
Non-harmonic spurious <sup>3</sup>	PSPUR	VSWR 10:1, all phases, RBIAS = 3.8 kΩ			-50	dBm
Transition time	t	RBIAS = 3.8 kΩ		0.5		μs
<b>Receive Bypass Mode: RX2 to Receive Output Path</b>						
Insertion loss	IL			3	5	dB
1 dB input compression point	IP1dB	1 dB gain compression	+14.0	+16.5		dBm
Third order input intercept point	IIP3	PIN = -30 dBm/tone, 200 kHz spacing		+30		dBm
Input return loss	IS11		8			dB
Output return loss	IS22		10			dB
Transition time <sup>2</sup>	t			0.5		μs
<b>Receive and Receive Bypass Mode: ANT to RX1 Path</b>						
Insertion loss	IL			0.9	1.4	dB
1 dB input compression point <sup>2</sup>	IP1dBANT	1 dB gain compression		+34		dBm
Third order input intercept point <sup>2</sup>	IIP3ANT	PIN = -10 dBm/tone, 200 kHz spacing		+50		dBm
Input return loss	IS11		10	13		dB
Output return loss	IS22		10	13		dB
Transition time <sup>2</sup>	t			0.5		μs

<sup>1</sup> Performance is guaranteed only under the conditions listed in this table. Modes are established as indicated in Table 2.  
<sup>2</sup> Not production tested.  
<sup>3</sup> Measurement performed with spectrum analyzer RBW = 100 kHz for frequencies < 1 GHz and RBW = 1 MHz for frequencies between 1 GHz and 10 GHz.

**Table 7. SKY65364-11 Electrical Specifications: Transmit Mode<sup>1</sup>**

**(VCC\_RX = VDD1 = 3.0 V to 3.45 V, VCC\_TX1/2/3 = VDD2 = 3.4 V to 3.8 V, P<sub>IN</sub> = +10 dBm, VPC = 2.25 V, T<sub>c</sub> = -40 °C to +85 °C, f = 890 to 960 MHz, 50 Ω Source and Load Impedance, CW Input, Unless Otherwise Noted)**

Parameter	Symbol	Test Condition	Min	Typ	Max	Units
<b><i>TX to ANT Path</i></b>						
Output power <sup>2</sup>	P <sub>OUT</sub>	T <sub>c</sub> = 25 °C, VCC_TX1/2/3 = 3.6 V	+30.0	+30.5		dBm
Output power variation over supply voltage		T <sub>c</sub> = 25 °C		±0.4		dB
Output power variation over temperature		VCC_TX1/2/3 = 3.6 V		±0.3		dB
Output power control	P <sub>CTL</sub>	VPC = 0 V to 2.25 V <sup>3</sup>	40	50		dB
Small signal transmit PA gain	G <sub>TX</sub>	P <sub>RF</sub> input @ -30 dBm		21.9		dB
Power-added efficiency <sup>5</sup>	PAE		36	38		%
2 <sup>nd</sup> harmonic	2fo				-50	dBc
3 <sup>rd</sup> to 10 <sup>th</sup> harmonic <sup>4</sup>	3fo to 10fo				-50	dBc
Input return loss	S <sub>11</sub>		14	21		dB
Output return loss	S <sub>22</sub>			6.5		dB
Non-harmonic spurious <sup>5,6</sup>	P <sub>SPUR</sub>	VSWR 10:1, all phases			-50	dBm
Power on time <sup>5</sup>	t			0.5		μs
<b><i>TX to ANT Path, Transmit Bypass Mode</i></b>						
Insertion loss	IL			2.7	3.3	dB
1 dB input compression point <sup>5</sup>	IP1dB			+30		dBm
Third order input intercept point <sup>5</sup>	IIP3			+40		dBm
2 <sup>nd</sup> harmonic	2fo	P <sub>IN</sub> = +12 dBm		-76	-40	dBc
3 <sup>rd</sup> harmonic	3fo	P <sub>IN</sub> = +12 dBm		-70	-40	dBc
Transmit bypass path rejection	R <sub>2fo</sub>	@ 2fo (1780 MHz to 1920 MHz)	27	39		dB
	R <sub>3fo</sub>	@ 3fo (2670 MHz to 2880 MHz)	34	49		dB
Input return loss	S <sub>11</sub>		8			dB
Output return loss	S <sub>22</sub>		10			dB
Transition time <sup>5</sup>	t			0.5		μs
<b><i>ANT to RX1 Path</i></b>						
Isolation	S <sub>21</sub>		18.0	20.3		dB
<b><i>ANT to RX1 Path, Transmit Bypass Mode</i></b>						
Isolation	S <sub>21</sub>		18	29		dB

<sup>1</sup> Performance is guaranteed only under the conditions listed in this table. Modes are established as indicated in Table 2.

<sup>2</sup> Output power rated at the antenna output. PA output power is actually 1.5 dB higher or +32 dBm for a P<sub>OUT</sub> of +30.5 dBm.

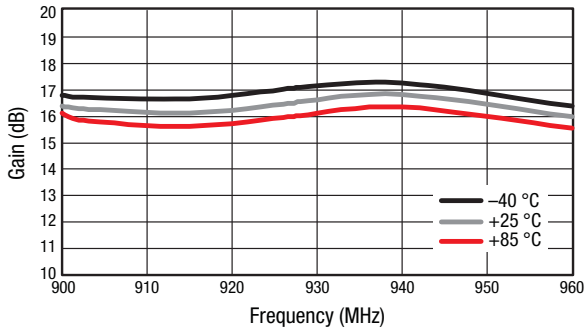
<sup>3</sup> Output power control is the difference between the output power at VPC = 2.25 V and VPC = 0 V.

<sup>4</sup> Only the 2<sup>nd</sup> to 5<sup>th</sup> harmonics have been production tested. The 6<sup>th</sup> to 10<sup>th</sup> harmonics are characterized only.

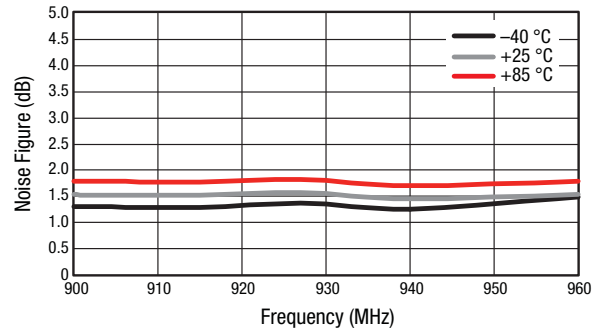
<sup>5</sup> Not production tested.

<sup>6</sup> Measurement performed with spectrum analyzer RBW = 100 kHz for frequencies < 1 GHz and RBW = 1 MHz for frequencies between 1 GHz and 10 GHz.

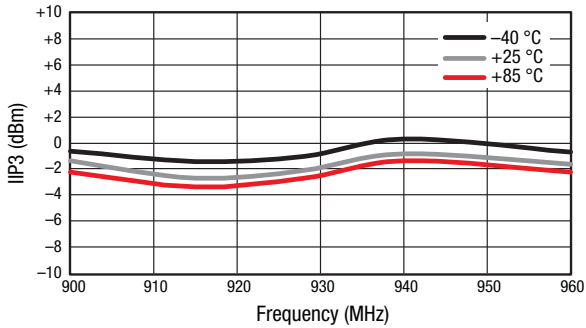
### Typical Performance Characteristics



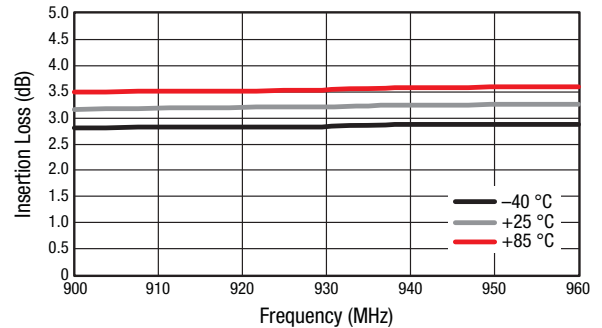
**Figure 3. Receive Mode (RX2 to RX0) Small Signal Gain vs Frequency Over Temperature**



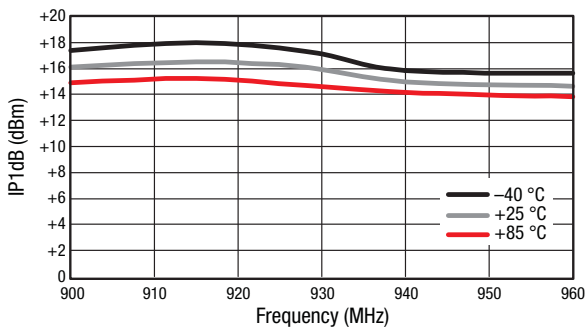
**Figure 4. Receive Mode (RX2 to RX2) Noise Figure vs Frequency Over Temperature**



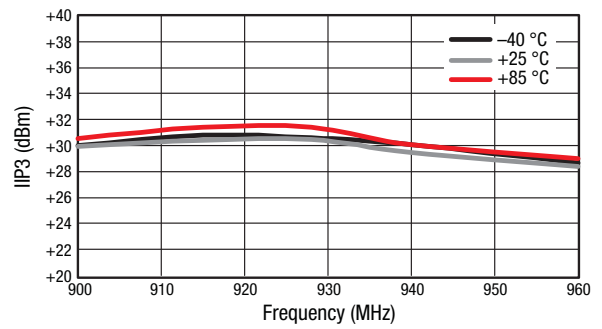
**Figure 5. Receive Mode (RX2 to RX0) IIP3 vs Frequency Over Temperature**



**Figure 6. Receive Bypass Mode (RX2 to RX0) Insertion Loss vs Frequency Over Temperature**

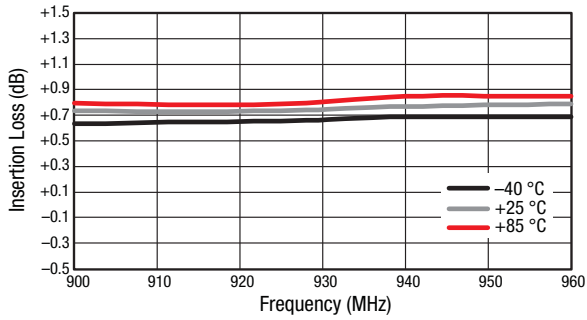


**Figure 7. Receive Bypass Mode (RX2 to RX0) IP1dB vs Frequency Over Temperature**

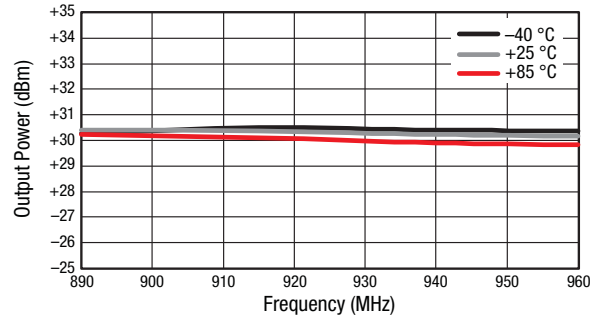


**Figure 8. Receive Bypass Mode (RX2 to RX0) IIP3 vs Frequency Over Temperature**

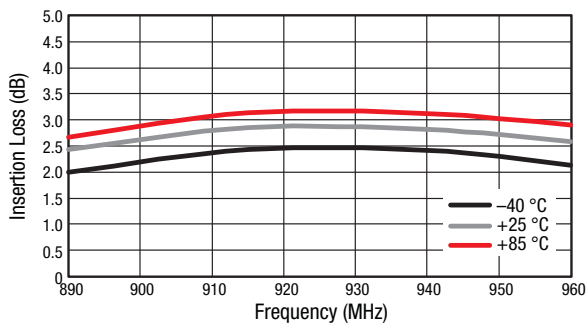




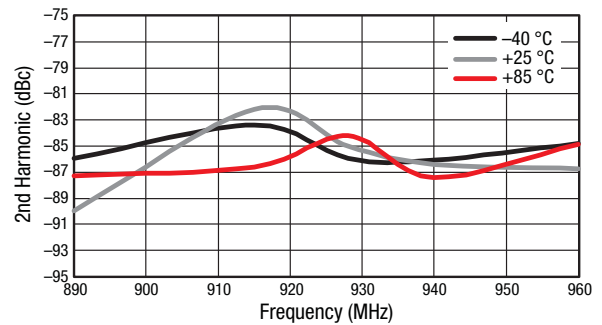
**Figure 9. Receive Bypass Mode (ANT to RX1) Insertion Loss vs Frequency Over Temperature**



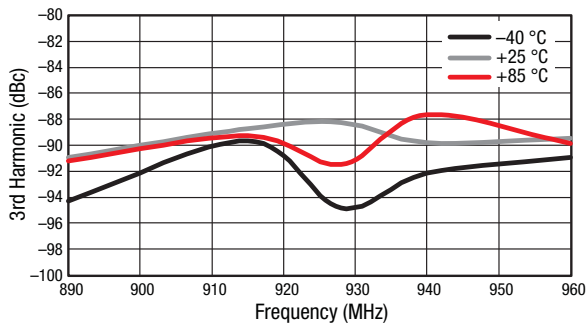
**Figure 10. Transmit Mode (TX to ANT) Output Power vs Frequency Over Temperature**



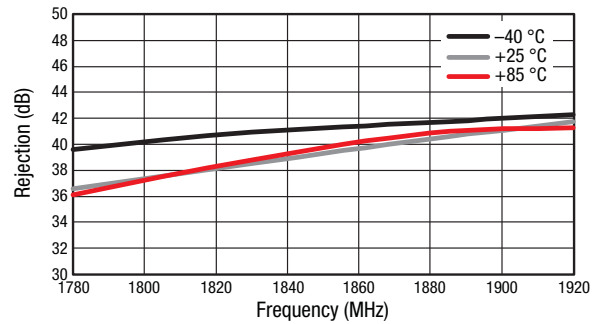
**Figure 11. Transmit Bypass Mode (TX to ANT) Insertion Loss vs Frequency Over Temperature**



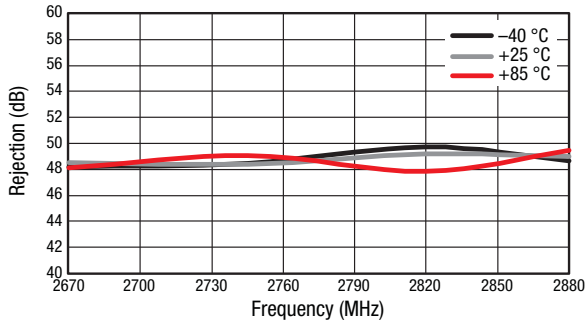
**Figure 12. Transmit Bypass Mode (TX to ANT) 2<sup>nd</sup> Harmonic vs Frequency Over Temperature**



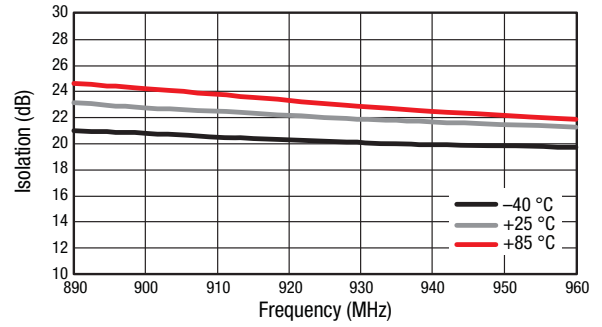
**Figure 13. Transmit Bypass Mode (TX to ANT) 3<sup>rd</sup> Harmonic vs Frequency Over Temperature**



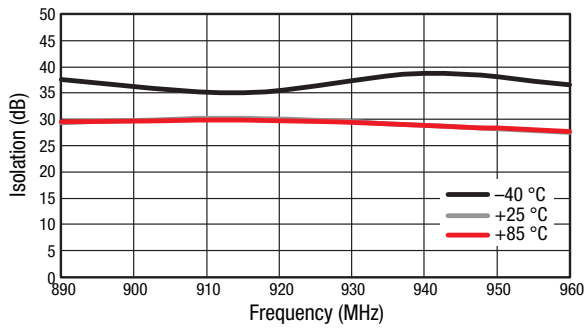
**Figure 14. Transmit Bypass Path Rejection vs Frequency Over Temperature**



**Figure 15. Transmit Bypass Path Rejection vs Frequency Over Temperature**



**Figure 16. Transmit Mode (ANT to RX1) Isolation vs Frequency Over Temperature**

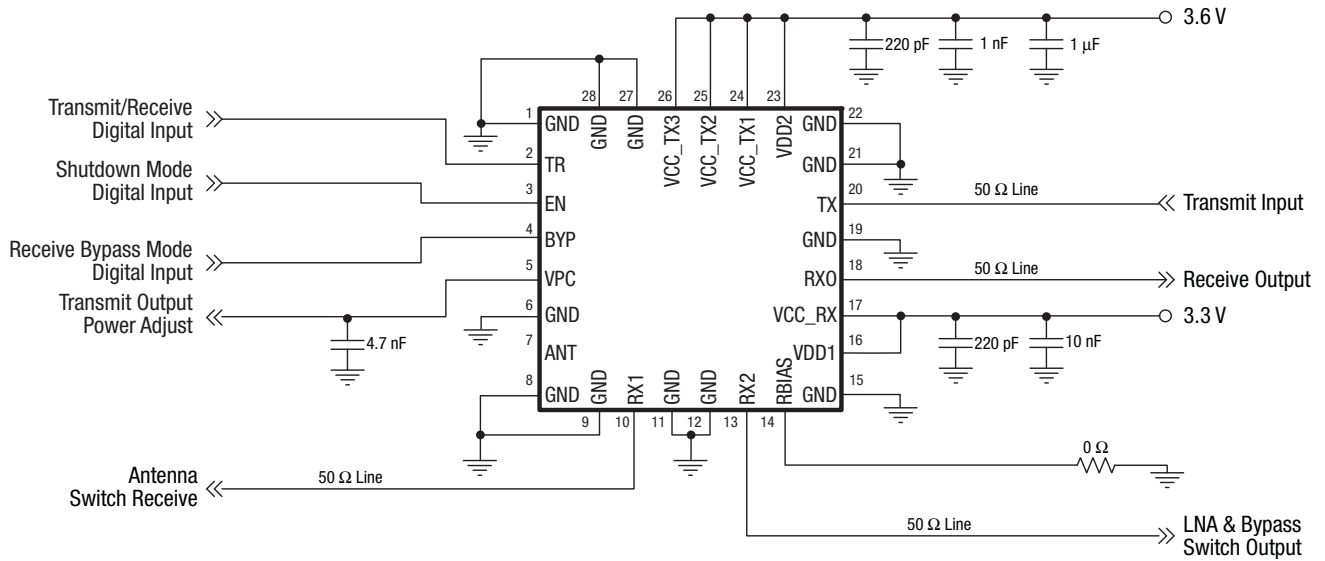


**Figure 17. Transmit Bypass Mode (ANT to RX1) Isolation vs Frequency Over Temperature**

### Evaluation Board Description

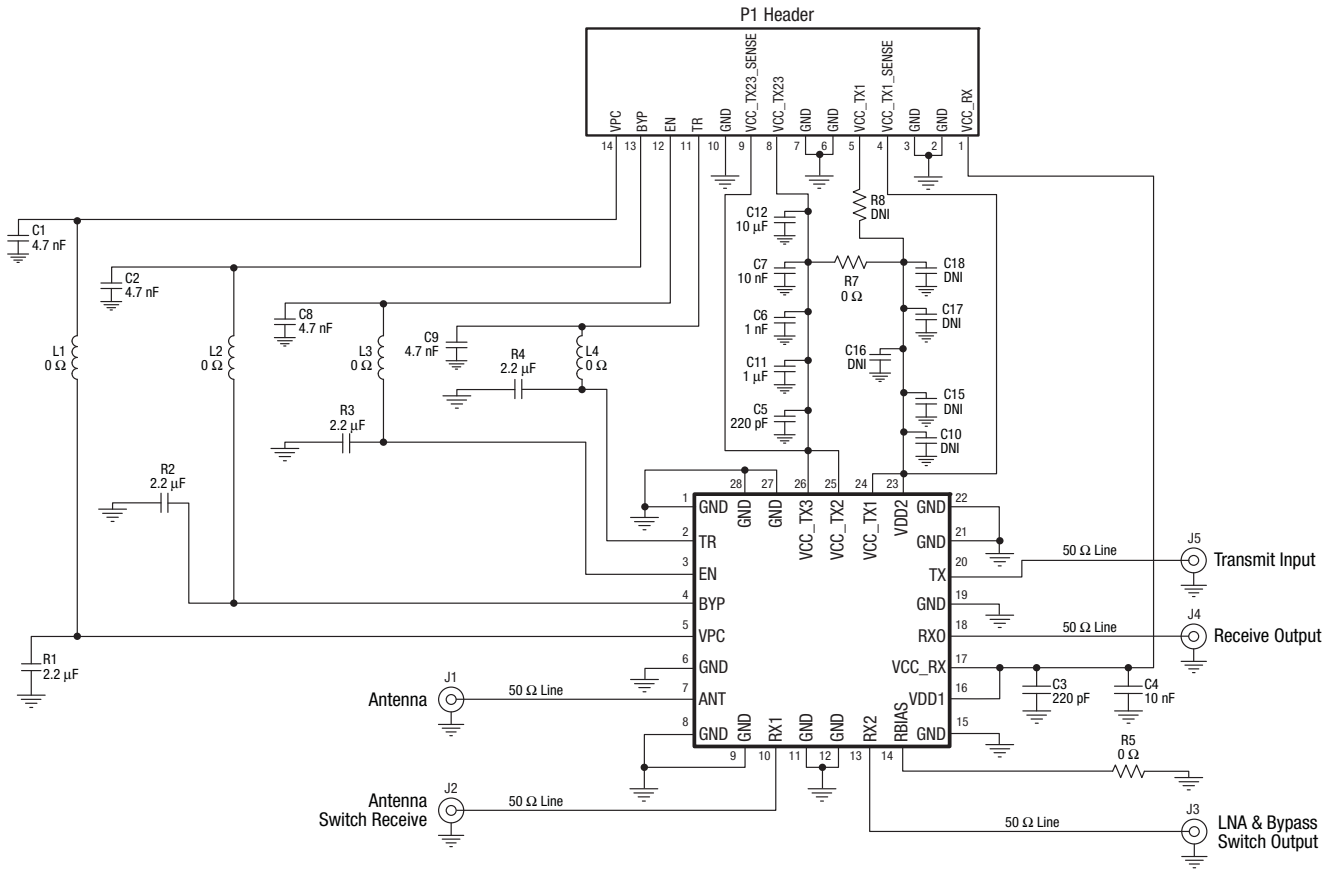
The SKY65364-11 Evaluation Board is used to test the performance of the SKY65364-11 T/R FEM. A typical application schematic diagram is provided in Figure 18.

An Evaluation Board schematic diagram is provided in Figure 19. An assembly drawing for the Evaluation Board is shown in Figure 20 and the layer is provided in Figure 21.



S2890

Figure 18. SKY65364-11 Typical Application Schematic



Note: Some component labels may be different than the corresponding component symbol shown here. Component values, however, are accurate as of the date of this Data Sheet.

S2875

Figure 19. SKY65364-11 Evaluation Board Schematic

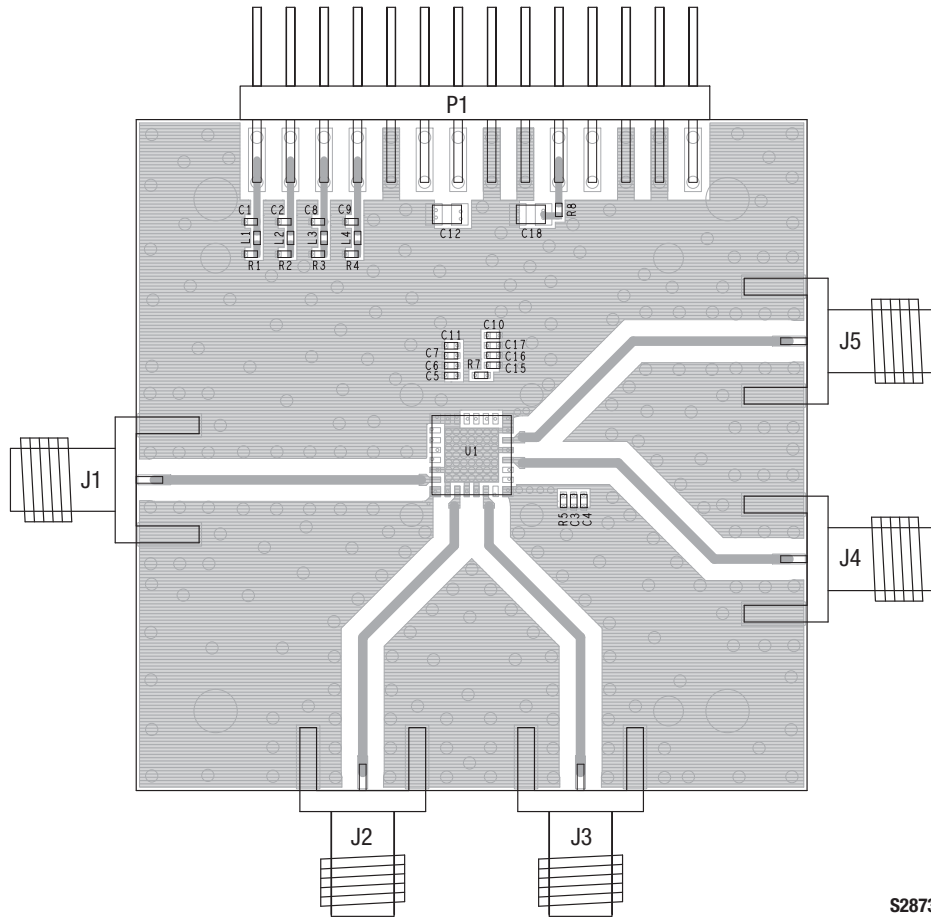
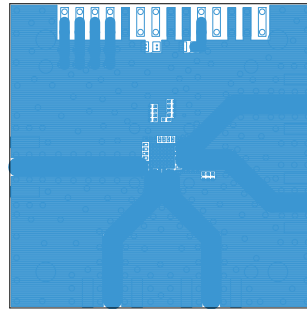
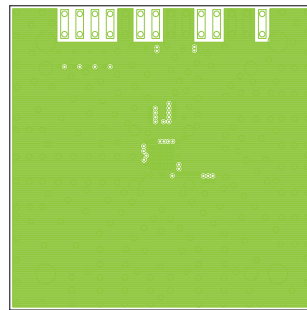


Figure 20. SKY65364-11 Evaluation Board Assembly Diagram

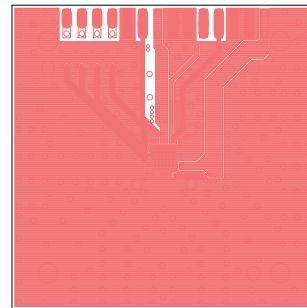
S2873



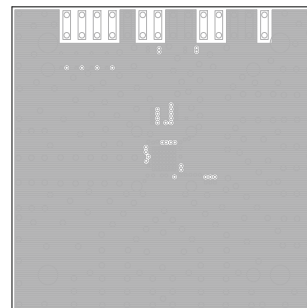
Layer 1: Top – Metal



Layer 2: Ground



Layer 3: Ground



Layer 4: Solid Ground Plane

S2874

**Figure 21. SKY65364-11 Evaluation Board Layer Detail**

## Package Dimensions

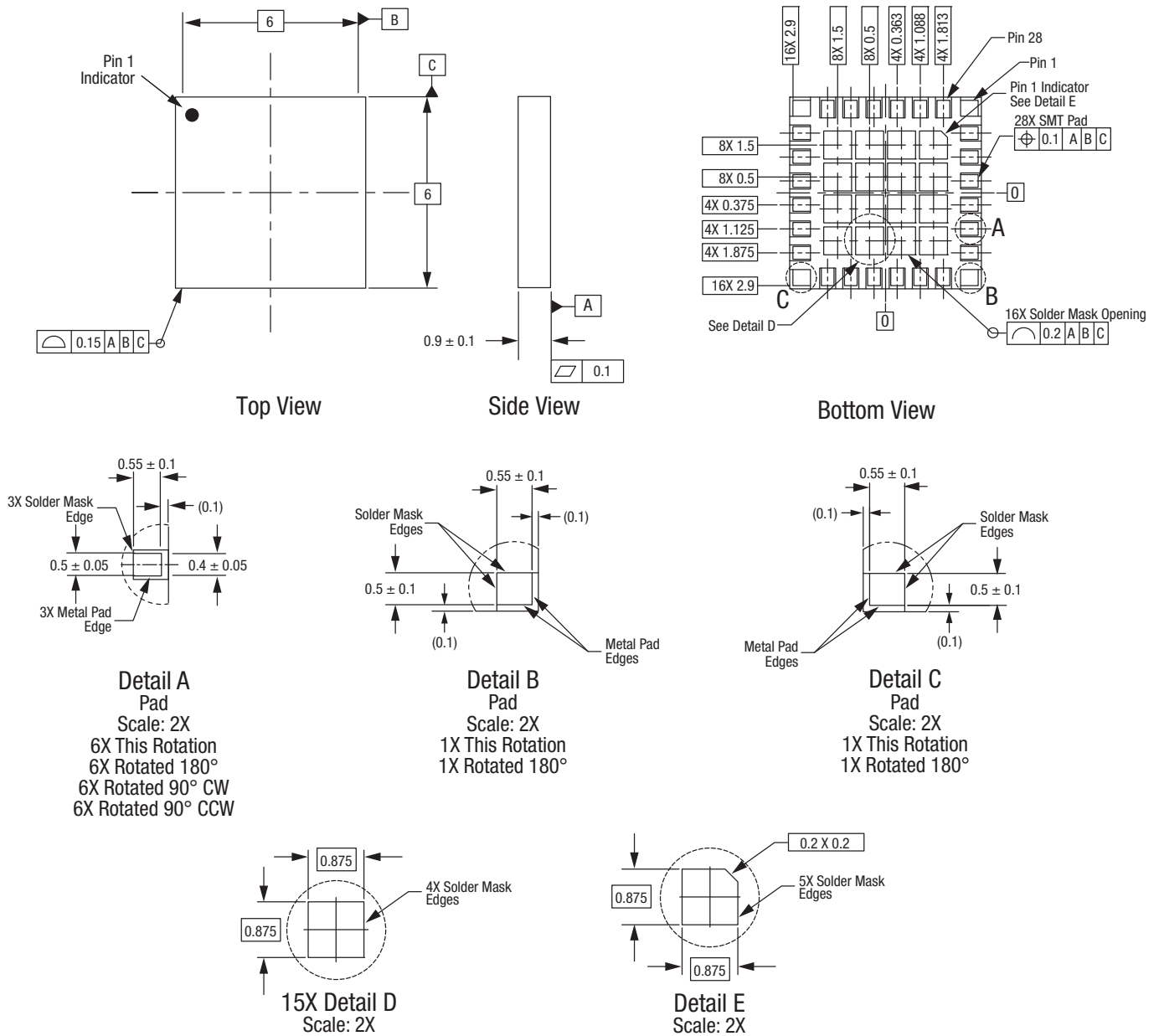
Package dimensions are shown in Figure 22, and tape and reel dimensions are provided in Figure 23.

## Package and Handling Information

Since the device package is sensitive to moisture absorption, it is baked and vacuum packed before shipping. Instructions on the shipping container label regarding exposure to moisture after the container seal is broken must be followed. Otherwise, problems related to moisture absorption may occur when the part is subjected to high temperature during solder assembly.

The SKY65364-11 is rated to Moisture Sensitivity Level 3 (MSL3) at 260 °C. It can be used for lead or lead-free soldering. For additional information, refer to Skyworks Application Note, *PCB Design and SMT Assembly/Rework Guidelines for MCM-L Packages*, document number 101752.

Care must be taken when attaching this product, whether it is done manually or in a production solder reflow environment. Production quantities of this product are shipped in a standard tape and reel format.



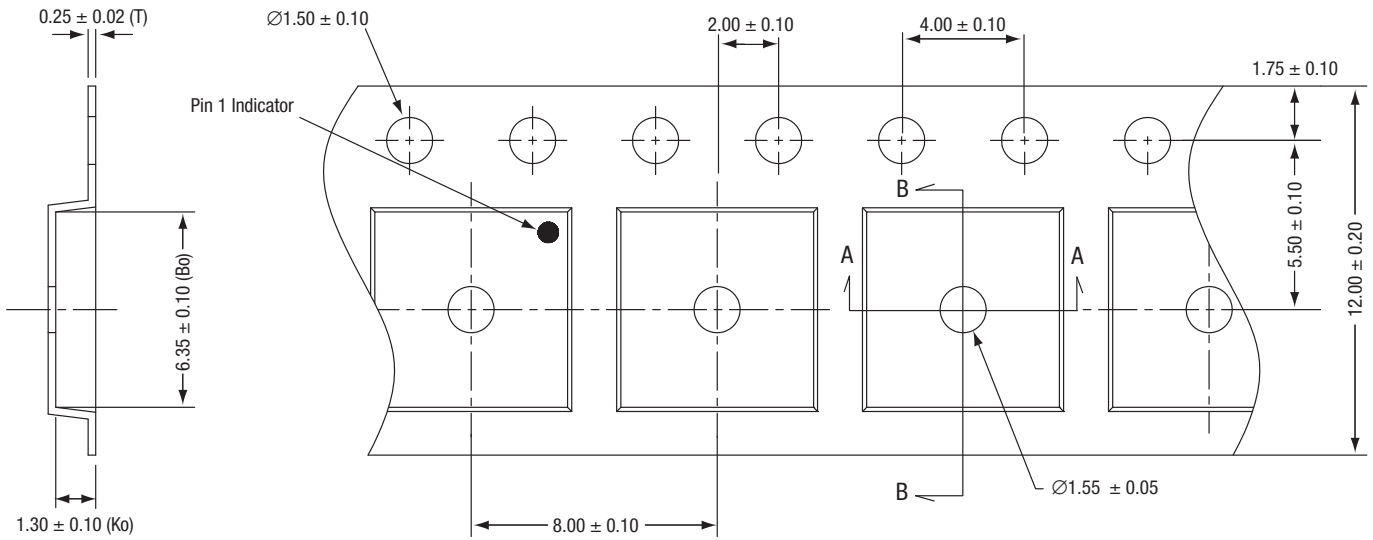
Notes:

1. All measurements are in millimeters.
2. Dimensioning and tolerancing according to ASME Y14.5M-1994.

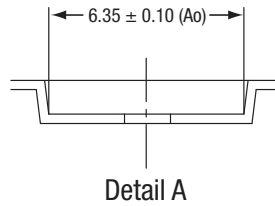
S2901

Figure 22. SKY65364-11 Package Dimensions





Detail B



Notes:

1. Carrier tape: black conductive polycarbonate or polystyrene.
2. Cover tape material: transparent conductive PSA.
3. Cover tape size: 9.3 mm width.
4. All dimensions are in millimeters.
5. ESD-surface resistivity is  $\leq 1 \times 10^{10}$  Ohms/square per EIA, JEDEC TNR Specification.

S1850

Figure 23. SKY65364-11 Tape and Reel Dimensions

## Ordering Information

Model Name	Manufacturing Part Number	Evaluation Board Part Number
SKY65364-11: T/R Front-End Module	SKY65364-11	SKY65364-11-EVB

Copyright © 2012, 2017 Skyworks Solutions, Inc. All Rights Reserved.

Information in this document is provided in connection with Skyworks Solutions, Inc. (“Skyworks”) products or services. These materials, including the information contained herein, are provided by Skyworks as a service to its customers and may be used for informational purposes only by the customer. Skyworks assumes no responsibility for errors or omissions in these materials or the information contained herein. Skyworks may change its documentation, products, services, specifications or product descriptions at any time, without notice. Skyworks makes no commitment to update the materials or information and shall have no responsibility whatsoever for conflicts, incompatibilities, or other difficulties arising from any future changes.

No license, whether express, implied, by estoppel or otherwise, is granted to any intellectual property rights by this document. Skyworks assumes no liability for any materials, products or information provided hereunder, including the sale, distribution, reproduction or use of Skyworks products, information or materials, except as may be provided in Skyworks Terms and Conditions of Sale.

THE MATERIALS, PRODUCTS AND INFORMATION ARE PROVIDED “AS IS” WITHOUT WARRANTY OF ANY KIND, WHETHER EXPRESS, IMPLIED, STATUTORY, OR OTHERWISE, INCLUDING FITNESS FOR A PARTICULAR PURPOSE OR USE, MERCHANTABILITY, PERFORMANCE, QUALITY OR NON-INFRINGEMENT OF ANY INTELLECTUAL PROPERTY RIGHT; ALL SUCH WARRANTIES ARE HEREBY EXPRESSLY DISCLAIMED. SKYWORKS DOES NOT WARRANT THE ACCURACY OR COMPLETENESS OF THE INFORMATION, TEXT, GRAPHICS OR OTHER ITEMS CONTAINED WITHIN THESE MATERIALS. SKYWORKS SHALL NOT BE LIABLE FOR ANY DAMAGES, INCLUDING BUT NOT LIMITED TO ANY SPECIAL, INDIRECT, INCIDENTAL, STATUTORY, OR CONSEQUENTIAL DAMAGES, INCLUDING WITHOUT LIMITATION, LOST REVENUES OR LOST PROFITS THAT MAY RESULT FROM THE USE OF THE MATERIALS OR INFORMATION, WHETHER OR NOT THE RECIPIENT OF MATERIALS HAS BEEN ADVISED OF THE POSSIBILITY OF SUCH DAMAGE.

Skyworks products are not intended for use in medical, lifesaving or life-sustaining applications, or other equipment in which the failure of the Skyworks products could lead to personal injury, death, physical or environmental damage. Skyworks customers using or selling Skyworks products for use in such applications do so at their own risk and agree to fully indemnify Skyworks for any damages resulting from such improper use or sale.

Customers are responsible for their products and applications using Skyworks products, which may deviate from published specifications as a result of design defects, errors, or operation of products outside of published parameters or design specifications. Customers should include design and operating safeguards to minimize these and other risks. Skyworks assumes no liability for applications assistance, customer product design, or damage to any equipment resulting from the use of Skyworks products outside of stated published specifications or parameters.

Skyworks and the Skyworks symbol are trademarks or registered trademarks of Skyworks Solutions, Inc., in the United States and other countries. Third-party brands and names are for identification purposes only, and are the property of their respective owners. Additional information, including relevant terms and conditions, posted at [www.skyworksinc.com](http://www.skyworksinc.com), are incorporated by reference.