

SOT-23 Plastic-Encapsulate MOSFETS

■ Features

- $V_{DS} (V) = 100V$
- $I_D = 1.5 A (V_{GS} = 10V)$
- $R_{DS(ON)} < 245 m\Omega (V_{GS} = 10 V)$
- $R_{DS(ON)} < 265 m\Omega (V_{GS} = 4.5V)$

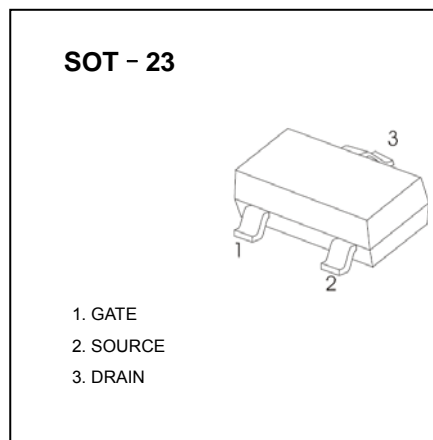

Equivalent Circuit

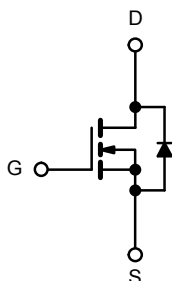

■ Absolute Maximum Ratings $T_a = 25^\circ C$

Parameter	Symbol	5 sec	Steady State	Unit
Drain-Source Voltage	V_{DS}	100		V
Gate-Source Voltage	V_{GS}	± 20		
Continuous Drain Current *1	I_D	$T_a=25^\circ C$	1.5	A
		$T_a=70^\circ C$	1.2	
Pulsed Drain Current *2	I_{DM}	6		mJ
Avalanche Current *2	I_{AS}	6		
Single Avalanche Energy	E_{AS}	1.8		
Power Dissipation *1	P_D	$T_a=25^\circ C$	1.25	W
		$T_a=70^\circ C$	0.8	
Thermal Resistance.Junction- to-Ambient *1 $t \leq 5$ sec	R_{thJA}	100		$^\circ C/W$
		Steady State		
Thermal Resistance.Junction-to-Foot	R_{thJF}	55		
Junction Temperature	T_J	150		$^\circ C$
Storage Temperature Range	T_{stg}	-55 to 150		

*1 Surface Mounted on 1" x 1" FR4 Board.

*2 Pulse width limited by maximum junction temperature

SOT-23 Plastic-Encapsulate MOSFETS
■ Electrical Characteristics Ta = 25°C

Parameter	Symbol	Test Conditions	Min	Typ	Max	Unit
Drain-Source Breakdown Voltage	V _{DSS}	I _D =1mA, V _{GS} =0V	100			V
Zero Gate Voltage Drain Current	I _{DSS}	V _{DS} =100V, V _{GS} =0V			1	μ A
		V _{DS} =100V, V _{GS} =0V, Ta=70°C			75	
Gate-Body Leakage Current	I _{GSS}	V _{DS} =0V, V _{GS} =±20V			±100	nA
Gate Threshold Voltage	V _{GS(th)}	V _{DS} =V _{GS} , I _D =250 μ A	2		4	V
On-State Drain Current *1	I _{D(on)}	V _{DS} ≥ 15 V, V _{GS} = 10 V	6			A
Static Drain-Source On-Resistance *1	R _{DS(on)}	V _{GS} =10V, I _D =1.5A			245	mΩ
		V _{GS} =4.5V, I _D = 1 A			265	mΩ
Forward Transconductance *1	g _{FS}	V _{DS} =15V, I _D =1.5A		4		S
Gate Resistance	R _g		0.5		2.4	Ω
Total Gate Charge	Q _g	V _{GS} =10V, V _{DS} =50V, I _D =1.5A		3.3	4	nC
Gate Source Charge	Q _{gs}			0.47		
Gate Drain Charge	Q _{gd}			1.45		
Turn-On DelayTime	t _{d(on)}	I _D =0.2A, V _{DS} =50V, V _{GEN} =10V R _L =33Ω, R _G =6Ω		7	11	ns
Turn-On Rise Time	t _r			11	17	
Turn-Off DelayTime	t _{d(off)}			9	15	
Turn-Off Fall Time	t _f			10	15	
Body Diode Reverse Recovery Time	t _{rr}	I _F = 1.5A, di/dt= 100A/ μ s		50	100	
Maximum Body-Diode Continuous Current	I _S				1.0	A
Diode Forward Voltage	V _{SD}	I _S =1.0A, V _{GS} =0V		0.8	1.2	V

*1 Pulse test: PW ≤ 300us duty cycle ≤ 2%.

■ Typical Characteristics

Output Characteristics

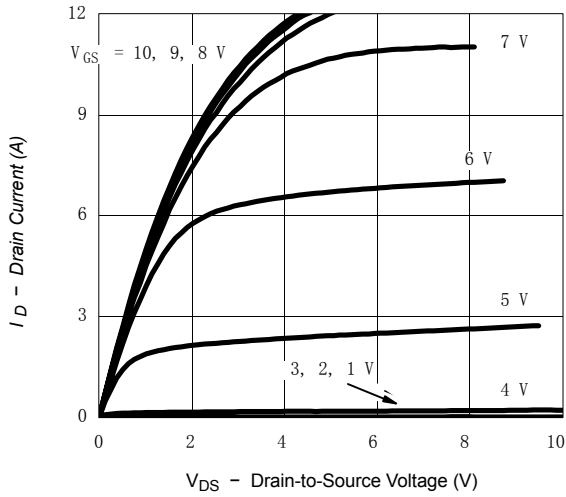

Transfer Characteristics

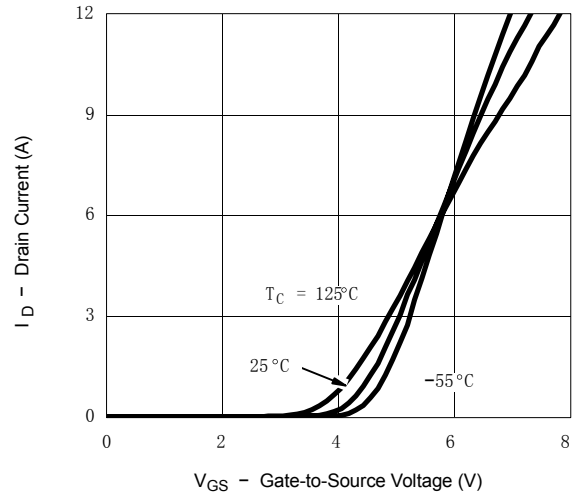

On-Resistance vs. Drain Current

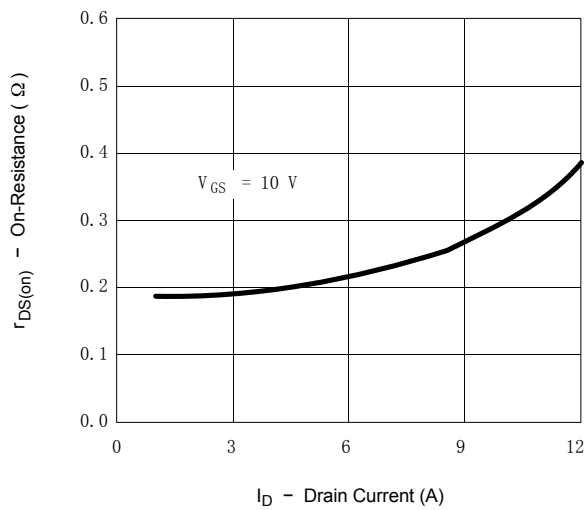

Capacitance

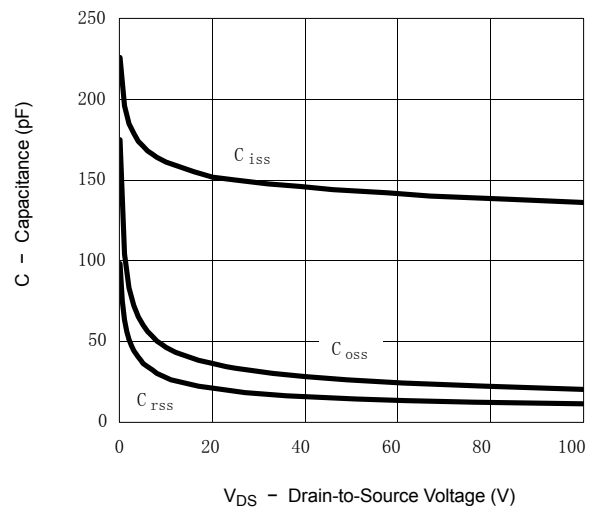

Gate Charge

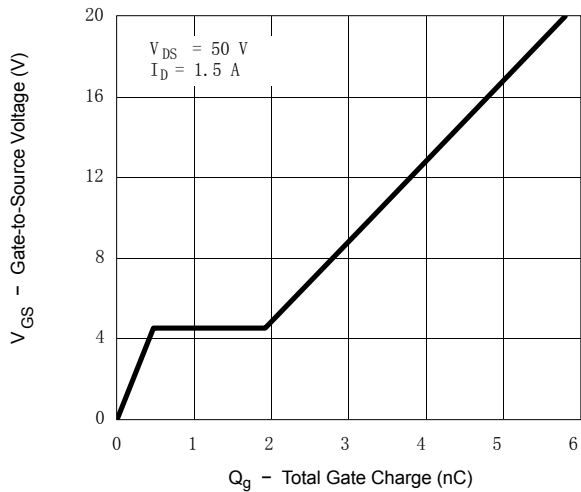

On-Resistance vs. Junction Temperature

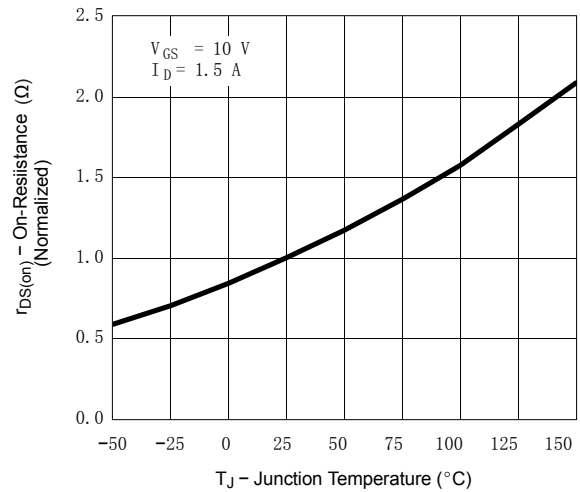

■ Typical Characteristics
Source-Drain Diode Forward Voltage

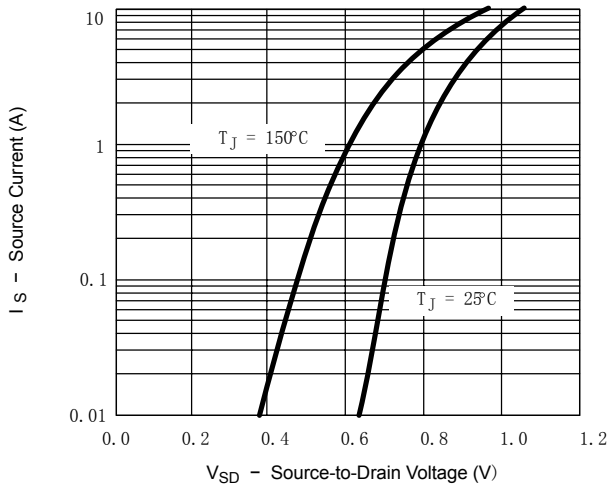

On-Resistance vs. Gate-to-Source Voltage

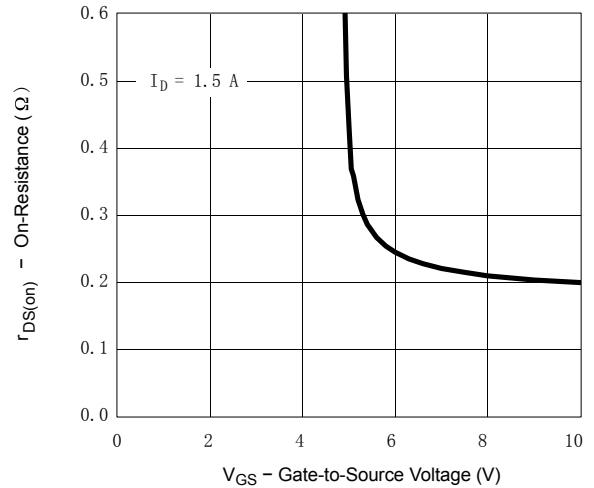

Threshold Voltage

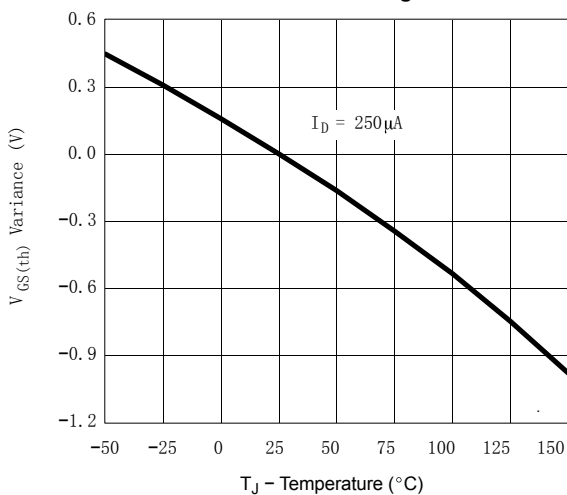

Single Pulse Power

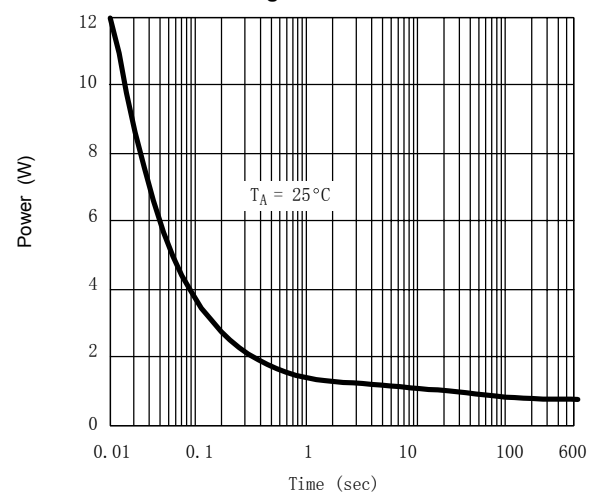

Normalized Thermal Transient Impedance, Junction-to-Ambient

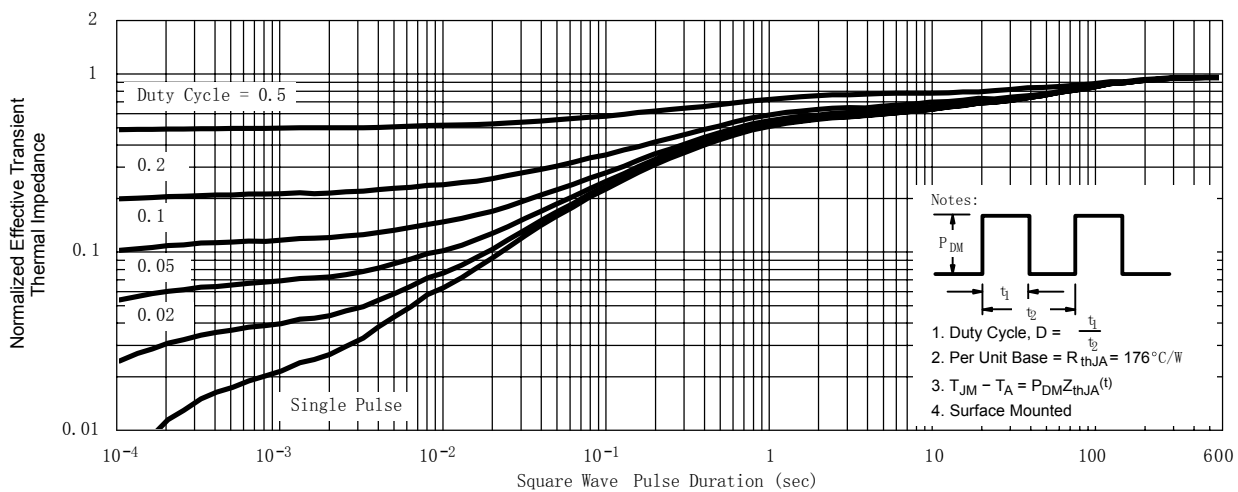

SOT-23 PACKAGE OUTLINE DIMENSIONS

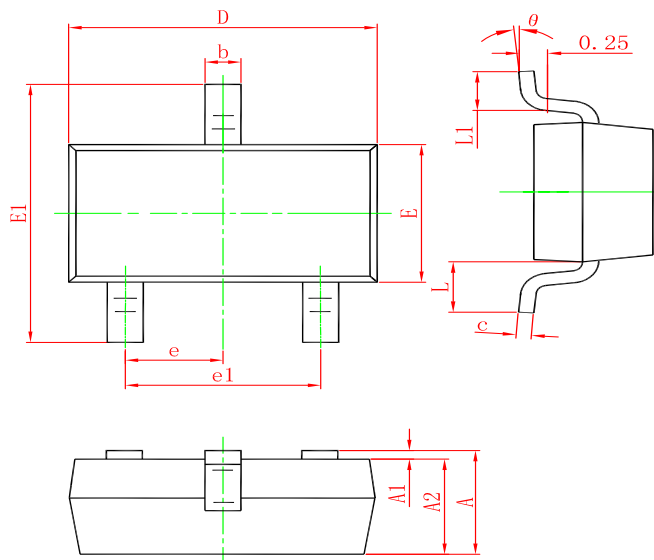

Symbol	Dimensions In Millimeters		Dimensions In Inches	
	Min.	Max.	Min.	Max.
A	0.900	1.150	0.035	0.045
A1	0.000	0.100	0.000	0.004
A2	0.900	1.050	0.035	0.041
b	0.300	0.500	0.012	0.020
c	0.080	0.150	0.003	0.006
D	2.800	3.000	0.110	0.118
E	1.200	1.400	0.047	0.055
E1	2.250	2.550	0.089	0.100
e	0.950 TYP.		0.037 TYP.	
e1	1.800	2.000	0.071	0.079
L	0.550 REF.		0.022 REF.	
L1	0.300	0.500	0.012	0.020
θ	0°	8°	0°	8°

Marking

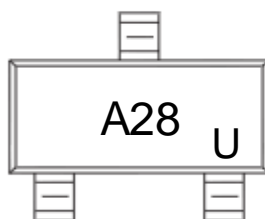

Ordering information

Order code	Package	Baseqty	Deliverymode
UMW SI2328A	SOT-23	3000	Tape and reel