

Features

- AEC-Q101 Qualification
- Lead Free Finish/RoHS Compliant ("P" Suffix Designates RoHS Compliant. See Ordering Information)
- Epoxy Meets UL 94 V-0 Flammability Rating
- Moisture Sensitivity Level 1
- Halogen Free. "Green" Device (Note 1)

Maximum Ratings

- Operating Junction Temperature Range : -55°C to +150°C
- Storage Temperature Range: -55°C to +150°C
- Thermal Resistance: 105°C/W Junction to Ambient (Note 2)

Parameter	Symbol	Rating	Unit
Drain-Source Voltage	V_{DS}	60	V
Gate-Source Voltage	V_{GS}	±20	V
Drain Current	I_D	3.0	A
Pulsed Drain Current (Note 3)	I_{DM}	10	A
Total Power Dissipation	P_D	1.2	W

Note: 1. Halogen free "Green" products are defined as those which contain <900ppm bromine, <900ppm chlorine (<1500ppm total Br + Cl) and <1000ppm antimony compounds.

2. Device Mounted on FR-4 PCB, 1 inch 2 pad of 2oz copper.

3. Repetitive Rating : Pulse Width Limited by Junction Temperature.

Internal Structure and Marking Code

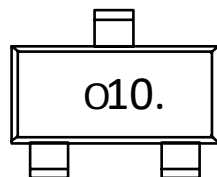
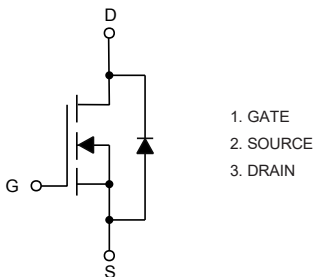

N-Channel Enhancement Mode Field Effect Transistor

SOT-23

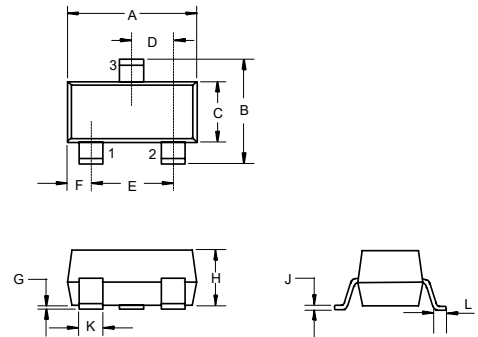

DIM	INCHES		MM		NOTE
	MIN	MAX	MIN	MAX	
A	0.110	0.120	2.80	3.04	
B	0.083	0.104	2.10	2.64	
C	0.047	0.055	1.20	1.40	
D	0.034	0.041	0.85	1.05	
E	0.067	0.083	1.70	2.10	
F	0.018	0.024	0.45	0.60	
G	0.0004	0.006	0.01	0.15	
H	0.035	0.043	0.90	1.10	
J	0.003	0.007	0.08	0.18	
K	0.014	0.020	0.35	0.51	
L	0.007	0.020	0.20	0.50	

Suggested Solder Pad Layout

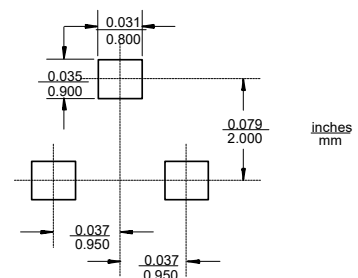

Electrical Characteristics @ 25°C (Unless Otherwise Specified)

Parameter	Symbol	Test Conditions	Min	Typ	Max	Unit
Static Characteristics						
Drain-Source Breakdown Voltage	$V_{(BR)DSS}$	$V_{GS}=0V, I_D=250\mu A$	60			V
Gate-Source Leakage Current	I_{GSS}	$V_{DS}=0V, V_{GS}=\pm 20V$			± 100	nA
		$V_{DS}=0V, V_{GS}=\pm 10V$			± 50	
Zero Gate Voltage Drain Current	I_{DSS}	$V_{DS}=60V, V_{GS}=0V$			1	μA
Gate-Threshold Voltage ^(Note4)	$V_{GS(th)}$	$V_{DS}=V_{GS}, I_D=250\mu A$	0.90		2.0	V
Drain-Source On-Resistance ^(Note4)	$R_{DS(on)}$	$V_{GS}=10V, I_D=3A$			100	m Ω
		$V_{GS}=4.5V, I_D=2A$			120	m Ω
Diode Forward Voltage ^(Note4)	V_{SD}	$V_{GS}=0V, I_S=3A$			1.2	V
Dynamic Characteristics^(Note5,6)						
Input Capacitance	C_{iss}	$V_{DS}=10V, V_{GS}=0V, f=1MHz$		409		pF
Output Capacitance	C_{oss}			50		
Reverse Transfer Capacitance	C_{rss}			41		
Total Gate Charge	Q_g	$V_{DS}=30V, V_{GS}=10V, I_D=3A$		10.27		nC
Gate-Source Charge	Q_{gs}			1.65		
Gate-Drain Charge	Q_{gd}			2.11		
Reverse Recovery Charge	Q_{rr}	$I_{SD}=3A, di/dt=100A/us$		6.99		ns
Reverse Recovery Time	T_{rr}			32.6		
Turn-On Delay Time	$t_{d(on)}$	$V_{GS}=10V, V_{DS}=30V,$ $R_L=20\Omega, R_G=3\Omega$		3.6		ns
Turn-On Rise Time	t_r			17.6		
Turn-Off Delay Time	$t_{d(off)}$			13		
Turn-Off Fall Time	t_f			23		

Note 4. Pulse Test : Pulse Width $\leq 300\mu s$, Duty Cycle $\leq 2\%$.

5. Switching characteristics are independent of operating junction temperature.

6. Guaranteed by Design, Not Subject to Production Testing.

Curve Characteristics

Fig. 1 - Output Characteristics

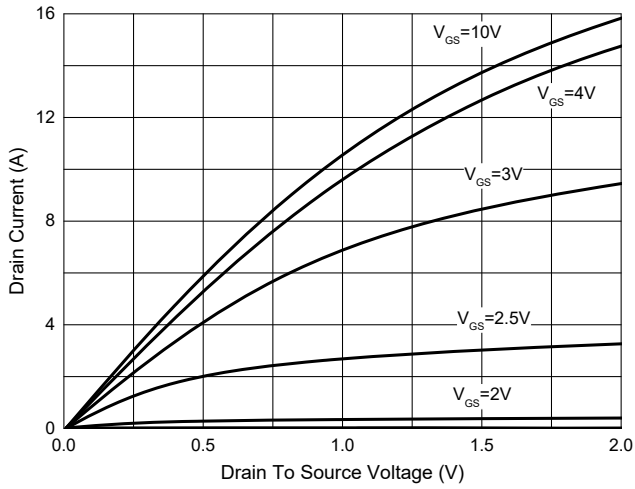

Fig. 2 - Transfer Characteristics

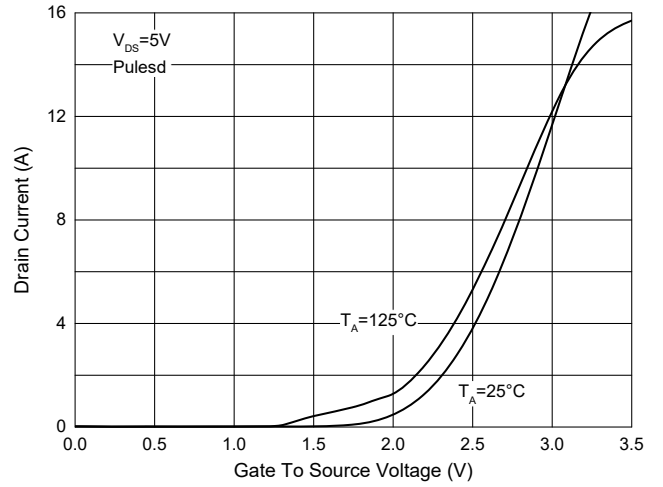

Fig. 3 - $R_{DS(ON)} - I_D$

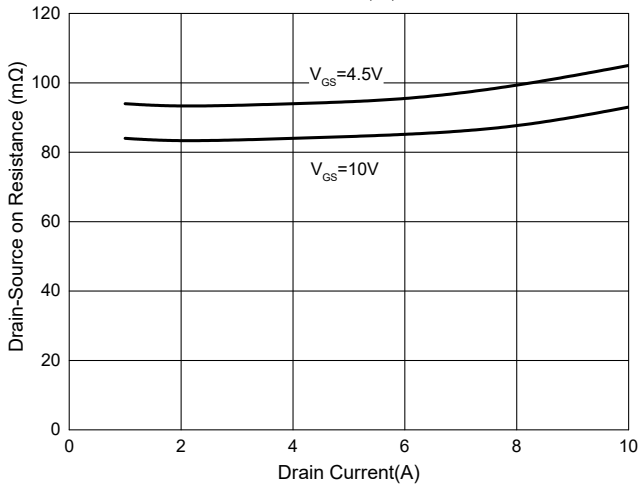

Fig. 4 - Normalized On Resistance Characteristics

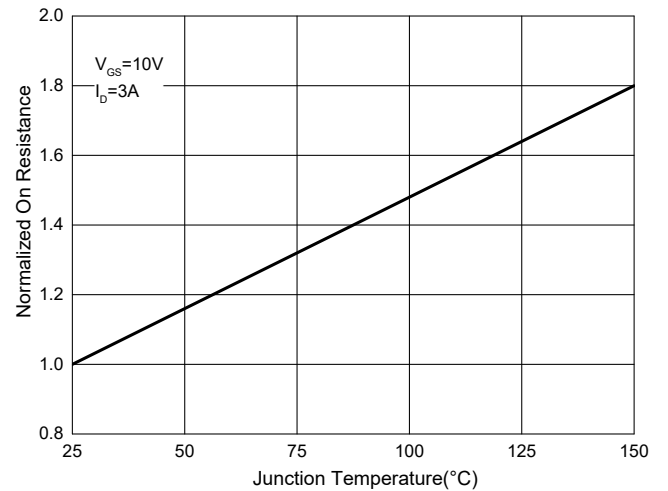

Fig. 5 - Gate Charge

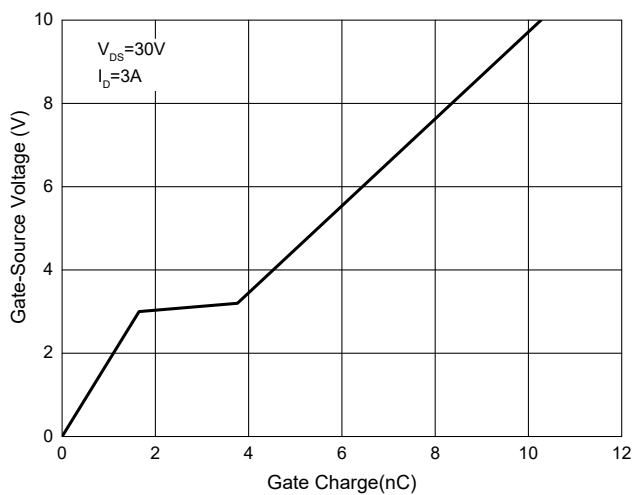
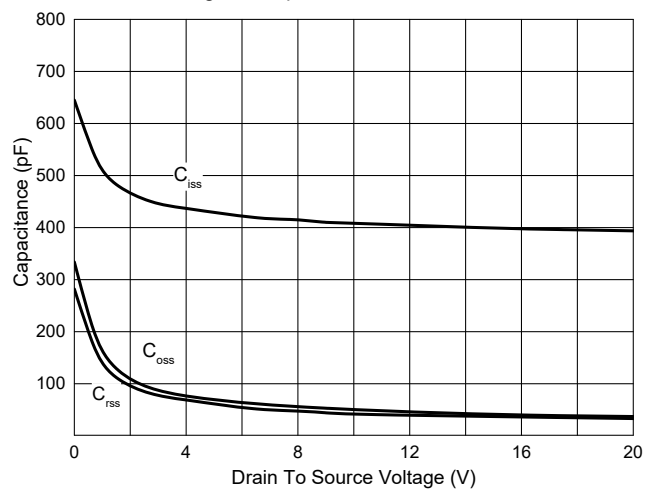

Fig. 6 - Capacitance Characteristics



Ordering Information

Device	Packing
Part Number-TP	Tape&Reel: 3Kpcs/Reel

*****IMPORTANT NOTICE*****

Micro Commercial Components Corp. reserves the right to make changes without further notice to any product herein to make corrections, modifications , enhancements , improvements , or other changes . **Micro Commercial Components Corp .** does not assume any liability arising out of the application or use of any product described herein; neither does it convey any license under its patent rights ,nor the rights of others . The user of products in such applications shall assume all risks of such use and will agree to hold **Micro Commercial Components Corp .** and all the companies whose products are represented on our website, harmless against all damages. **Micro Commercial Components Corp.** products are sold subject to the general terms and conditions of commercial sale, as published at <https://www.mccsemi.com/Home/TermsAndConditions>.

*****LIFE SUPPORT*****

MCC's products are not authorized for use as critical components in life support devices or systems without the express written approval of Micro Commercial Components Corporation.

*****CUSTOMER AWARENESS*****

Counterfeiting of semiconductor parts is a growing problem in the industry. Micro Commercial Components (MCC) is taking strong measures to protect ourselves and our customers from the proliferation of counterfeit parts. MCC strongly encourages customers to purchase MCC parts either directly from MCC or from Authorized MCC Distributors who are listed by country on our web page cited below. Products customers buy either from MCC directly or from Authorized MCC Distributors are genuine parts, have full traceability, meet MCC's quality standards for handling and storage. **MCC will not provide any warranty coverage or other assistance for parts bought from Unauthorized Sources.** MCC is committed to combat this global problem and encourage our customers to do their part in stopping this practice by buying direct or from authorized distributors.