

P-Channel Enhancement MOSFET

■ Features

- $V_{DS} (V) = -30V$
- $I_D = -3.0A (V_{GS} = -10V)$
- $R_{DS(ON)} < 50m\Omega (V_{GS} = -10V)$
- $R_{DS(ON)} < 70m\Omega (V_{GS} = -4.5V)$

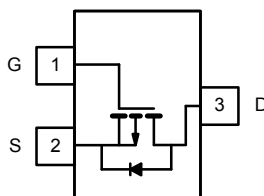
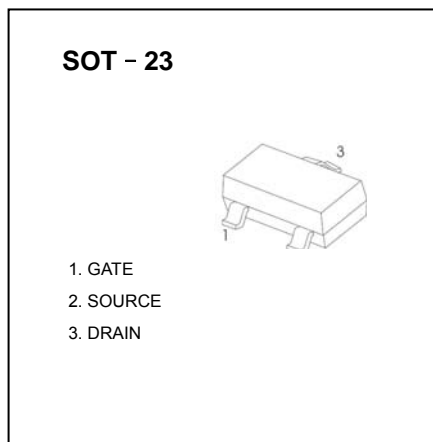

■ Absolute Maximum Ratings $T_a = 25^\circ C$

Parameter	Symbol	5 sec	Unit	
Drain-Source Voltage	V_{DS}	-30	V	
Gate-Source Voltage	V_{GS}	± 20		
Continuous Drain Current	I_D	$T_a = 25^\circ C$	A	
		$T_a = 70^\circ C$		-2.5
Pulsed Drain Current	I_{DM}	-12		
Power Dissipation	P_D	$T_a = 25^\circ C$	W	
		$T_a = 70^\circ C$		0.8
Thermal Resistance, Junction- to-Ambient	$t \leq 10 \text{ sec}$	R_{thJA}	100	$^\circ C/W$
Junction Temperature	T_J	150	$^\circ C$	
Junction and Storage Temperature Range	T_{stg}	-55 to 150		

P-Channel Enhancement MOSFET
■ Electrical Characteristics Ta = 25°C

Parameter	Symbol	Test Conditions	Min	Typ	Max	Unit
Drain-Source Breakdown Voltage	V _{DSS}	I _D =-250μA, V _{GS} =0V	-30			V
Zero Gate Voltage Drain Current	I _{DSS}	V _D =-24V, V _{GS} =0V			-1	μA
		V _D =-24V, V _{GS} =0V, T _J =55°C			-10	
Gate-Body leakage current	I _{GSS}	V _D =0V, V _{GS} =±20V			±100	nA
Gate Threshold Voltage	V _{GS(th)}	V _D =V _{GS} I _D =-250 μA	-1.0		-3.0	V
Static Drain-Source On-Resistance *1	R _{DS(on)}	V _{GS} =-10V, I _D =-3A			50	mΩ
		V _{GS} =-4.5V, I _D =-2.5A			70	
On state drain current *1	I _{D(ON)}	V _{GS} =-10V, V _D =-5V	-6			A
Forward Transconductance *1	g _{FS}	V _D =-10V, I _D =-3A		4.5		S
Input Capacitance	C _{iss}	V _{GS} =0V, V _D =-15V, f=1MHz		565		pF
Output Capacitance	C _{oss}			126		
Reverse Transfer Capacitance	C _{rss}			75		
Total Gate Charge	Q _g	V _{GS} =-15V, V _D =-15V, I _D =-3A		10	15	nC
Gate Source Charge	Q _{gs}			1.9		
Gate Drain Charge	Q _{gd}			2		
Turn-On DelayTime	t _{d(on)}	V _{GS} =-10V, V _D =-15V, R _L =15Ω, R _{GEN} =6Ω I _D =-1.0A		10	20	ns
Turn-On Rise Time	t _r			9	20	
Turn-Off DelayTime	t _{d(off)}			27	50	
Turn-Off Fall Time	t _f			7	16	
Maximum Body-Diode Continuous Current	I _S					
Diode Forward Voltage	V _{SD}	I _S =-1.25A, V _{GS} =0			-1.2	V

*1Pulse test: PW ≤ 300us duty cycle ≤ 2%.

■ Typical Characteristics

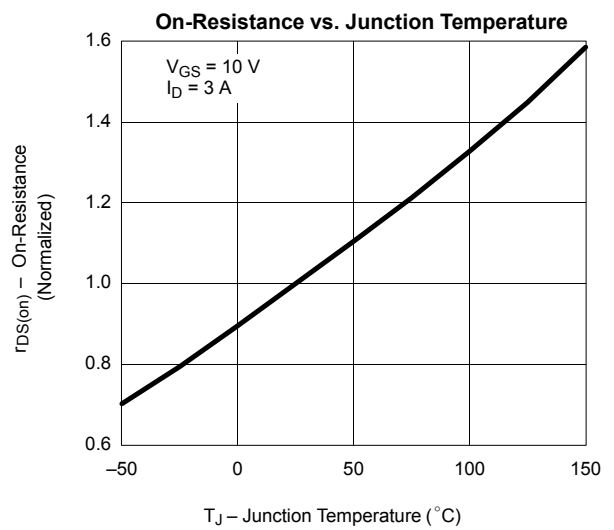
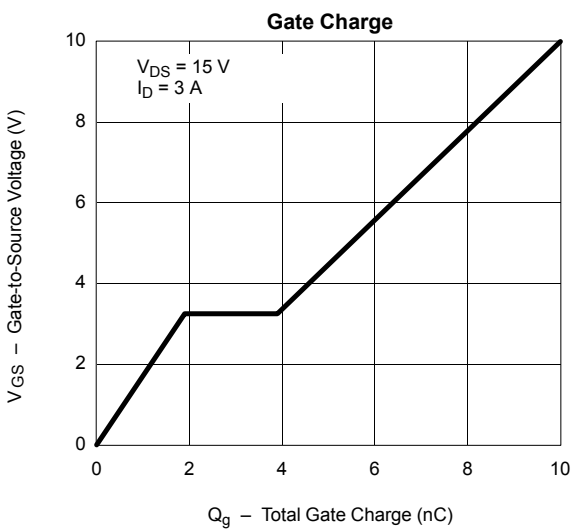
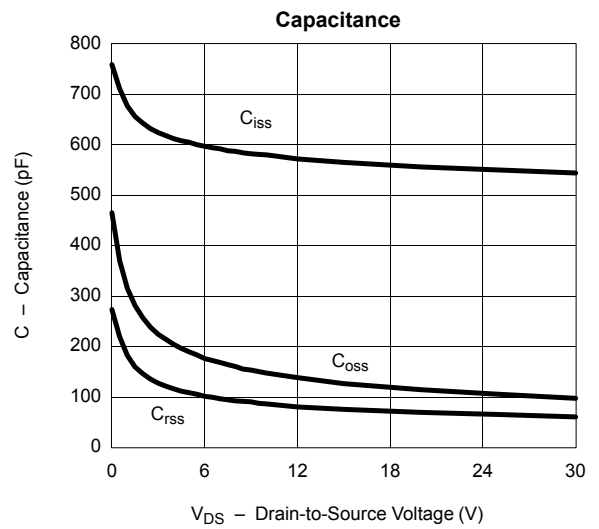
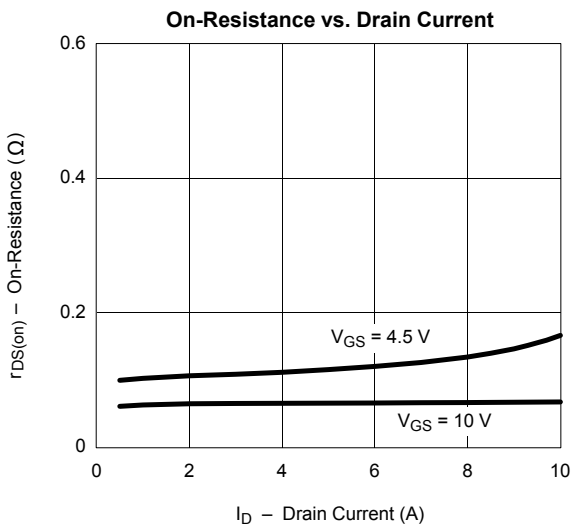
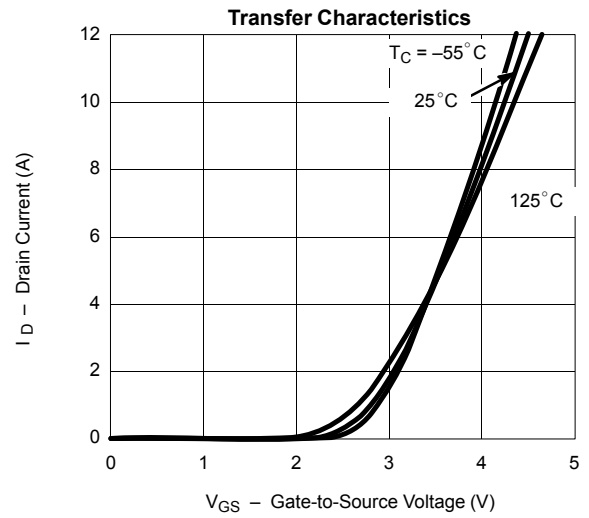
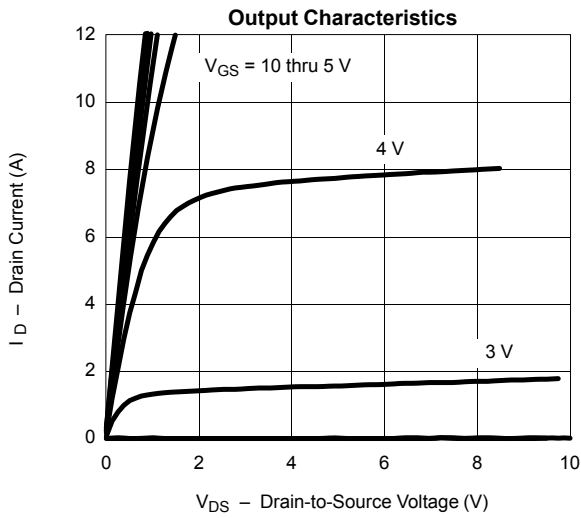

■ Typical Characteristics

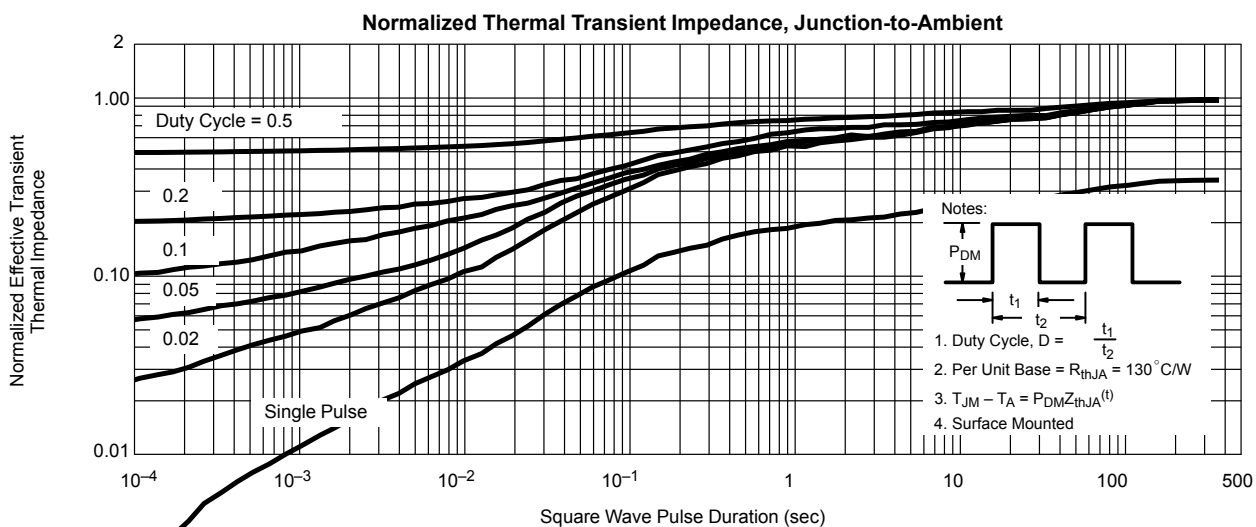
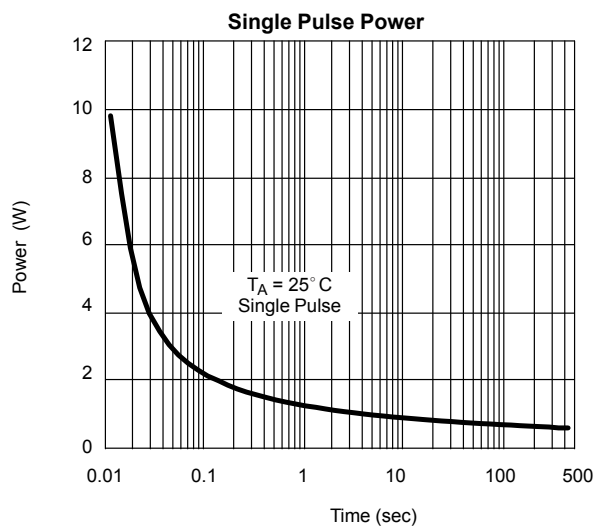
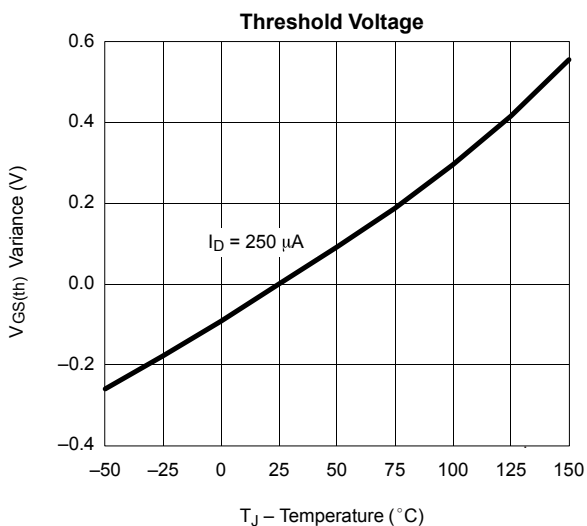
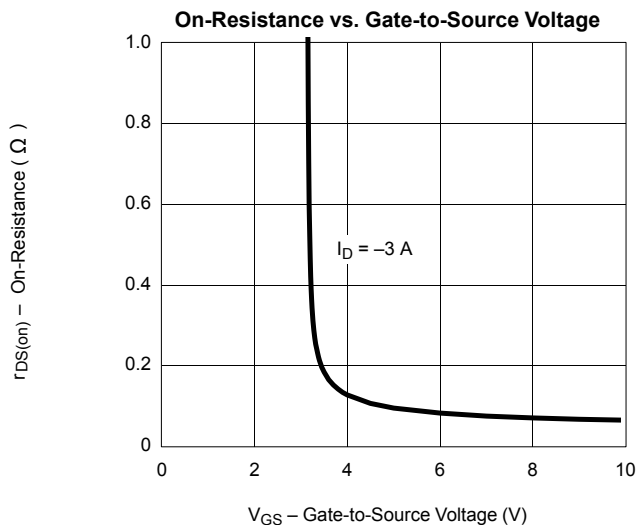
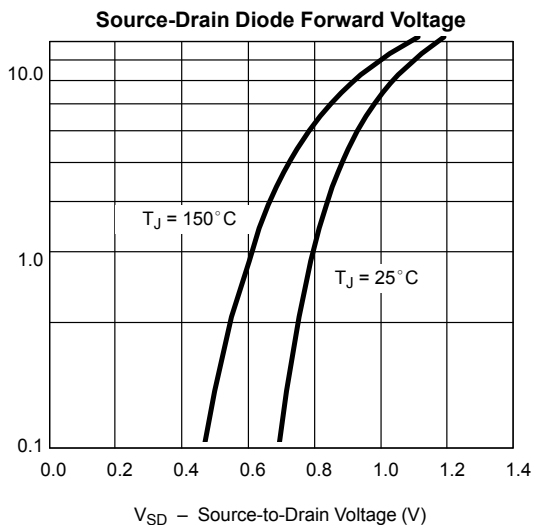

SOT-23 PACKAGE OUTLINE DIMENSIONS

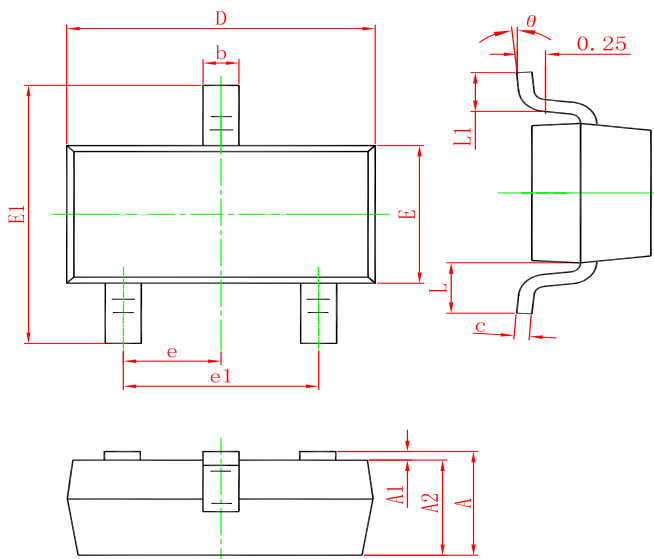

Symbol	Dimensions In Millimeters		Dimensions In Inches	
	Min.	Max.	Min.	Max.
A	0.900	1.150	0.035	0.045
A1	0.000	0.100	0.000	0.004
A2	0.900	1.050	0.035	0.041
b	0.300	0.500	0.012	0.020
c	0.080	0.150	0.003	0.006
D	2.800	3.000	0.110	0.118
E	1.200	1.400	0.047	0.055
E1	2.250	2.550	0.089	0.100
e	0.950 TYP.		0.037 TYP.	
e1	1.800	2.000	0.071	0.079
L	0.550 REF.		0.022 REF.	
L1	0.300	0.500	0.012	0.020
θ	0°	8°	0°	8°

Marking

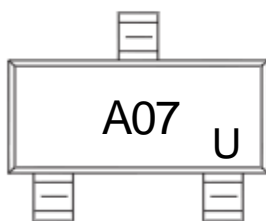

Ordering information

Order code	Package	Baseqty	Deliverymode
UMW SI2307A	SOT-23	3000	Tape and reel