

BIOFY® Sensor

Version 1.2

SFH 7072



Features:

- Multi chip package featuring two green emitters, one red emitter, one infrared emitter and two detectors
- Package size: (WxDxH) 7.5 mm x 3.9 mm x 0.9 mm
- Light Barriers to block optical crosstalk
- optimized for strong PPG signal

Applications

- Heart rate monitoring
- Pulse oximetry

for:

- Wearable devices (e.g. smart watches, fitness trackers, ...)
- Mobile devices

Ordering Information

Type	Ordering Code
SFH7072	Q65112A1516

Pin configuration

Pin	Name	Function
1	BPC	Broadband photodiode cathode
2	BPA	Broadband photodiode anode
3	IPC	IR-Cut photodiode cathode
4	IA	Infrared LED anode
5	G1A	Green LED 1 anode
6	G1C	Green LED 1 cathode
7	RA	Red LED anode
8	RC	Red LED cathode
9	IC	Infrared LED cathode
10	IPA	IR-Cut photodiode anode
11	G2A	Green LED 2 anode
12	G2C	Green LED 2 cathode

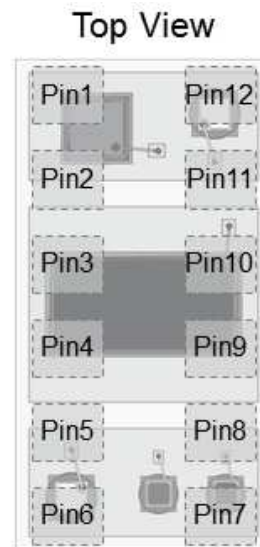

Block diagram

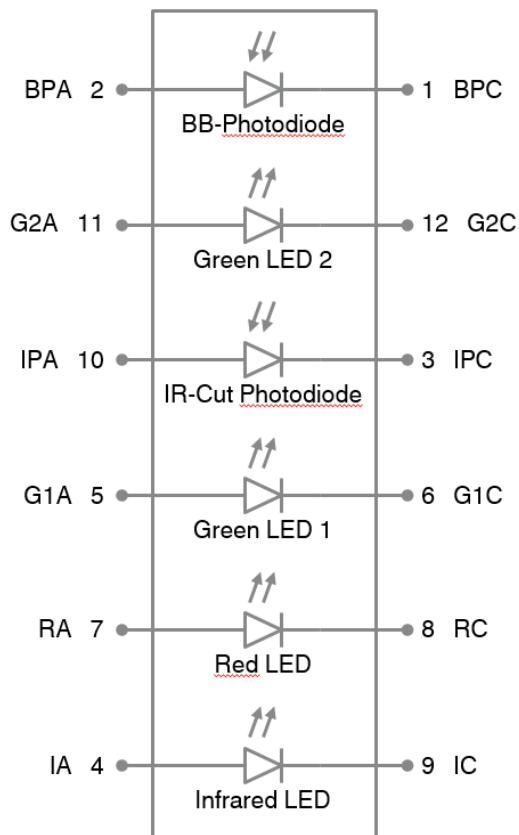

Maximum Ratings ($T_A = 25\text{ °C}$)

Parameter	Symbol	Values	Unit
General			
Operating temperature range	T_{op}	-40 ... 85	°C
Storage temperature range	T_{stg}	-40 ... 85	°C
ESD withstand voltage (acc. to ANSI/ ESDA/ JEDEC JS-001 - HBM)	V_{ESD}	2	kV
Infrared Emitter			
Reverse Voltage	V_R	5	V
Forward current	$I_{F(DC)}$	60	mA
Surge current ($t_p = 100\ \mu\text{s}$, $D = 0$)	I_{FSM}	1	A
Red Emitter			
Reverse voltage	V_R	12	V
Forward current	$I_{F(DC)}$	40	mA
Surge current ($t_p = 100\ \mu\text{s}$, $D = 0$)	I_{FSM}	600	mA
Green Emitters			
Reverse voltage	V_R	5	V
Forward current	$I_{F(DC)}$	25	mA
Surge current ($t_p = 10\ \mu\text{s}$, $D = 0$)	I_{FSM}	300	mA
Detectors			
Reverse voltage	V_R	16	V

Characteristics ($T_A = 25\text{ °C}$)

Parameter		Symbol	Value	Unit
Infrared Emitter				
Wavelength of peak emission ($I_F = 20\text{ mA}$, $t_p = 20\text{ ms}$)	(typ.)	λ_{peak}	950	nm
Centroid Wavelength ($I_F = 20\text{ mA}$, $t_p = 20\text{ ms}$)	(typ. (max.))	$\lambda_{\text{centroid}}$	940 (± 10)	nm
Spectral bandwidth at 50% of I_{max} ($I_F = 20\text{ mA}$, $t_p = 20\text{ ms}$)	(typ.)	$\Delta\lambda$	42	nm
Half angle	(typ.)	φ	± 60	$^\circ$
Rise and fall time of I_e (10% and 90% of $I_{e\text{max}}$) ($I_F = 100\text{ mA}$, $t_p = 16\text{ }\mu\text{s}$, $R_L = 50\text{ }\Omega$)	(typ.)	t_r , t_f	16	ns
Forward voltage ($I_F = 20\text{ mA}$, $t_p = 20\text{ ms}$)	(typ. (max.))	V_F	1.3 (≤ 1.8)	V
Reverse current ($V_R = 5\text{ V}$)		I_R	not designed for reverse operation	μA
Radiant intensity ($I_F = 20\text{ mA}$, $t_p = 20\text{ ms}$)	(typ.)	I_e	3.9	mW / sr
Total radiant flux ($I_F = 20\text{ mA}$, $t_p = 20\text{ ms}$)	(typ.)	Φ_e	11	mW
Temperature coefficient of I_e or Φ_e ($I_F = 20\text{ mA}$, $t_p = 20\text{ ms}$)	(typ.)	TC_I	-0.3	% / K
Temperature coefficient of V_F ($I_F = 20\text{ mA}$, $t_p = 20\text{ ms}$)	(typ.)	TC_V	-0.8	mV / K
Temperature coefficient of $\lambda_{\text{centroid}}$ ($I_F = 20\text{ mA}$, $t_p = 20\text{ ms}$)	(typ.)	$TC_{\lambda_{\text{centroid}}}$	0.25	nm / K

Characteristics ($T_A = 25\text{ °C}$)

Parameter		Symbol	Value	Unit
Red Emitter				
Wavelength of peak emission ($I_F = 20\text{ mA}$)	(typ.)	λ_{peak}	660	nm
Centroid Wavelength ($I_F = 20\text{ mA}$)	(typ. (max.))	$\lambda_{\text{centroid}}$	655 (± 3)	nm
Spectral bandwidth at 50% of I_{max} ($I_F = 20\text{ mA}$)	(typ.)	$\Delta\lambda$	17	nm
Half angle	(typ.)	φ	± 60	°
Rise and fall time of I_e (10% and 90% of $I_{e\text{max}}$) ($I_F = 100\text{ mA}$, $t_p = 16\text{ }\mu\text{s}$, $R_L = 50\text{ }\Omega$)	(typ.)	t_r, t_f	17	ns
Forward voltage ($I_F = 20\text{ mA}$)	(typ. (max.))	V_F	2.1 (≤ 2.8)	V
Reverse current ($V_R = 12\text{V}$)		I_R	not designed for reverse operation	μA
Radiant intensity ($I_F = 20\text{ mA}$, $t_p = 20\text{ ms}$)	(typ.)	I_e	4.8	mW / sr
Total radiant flux ($I_F = 20\text{ mA}$, $t_p = 20\text{ ms}$)	(typ.)	Φ_e	14	mW
Temperature coefficient of $\lambda_{\text{centroid}}$ ($I_F = 20\text{ mA}$, $-10\text{ °C} \leq T \leq 100\text{ °C}$)	(typ.)	$\text{TC}_{\lambda_{\text{centroid}}}$	0.13	nm / K

Characteristics ($T_A = 25\text{ °C}$)

Parameter		Symbol	Value	Unit
Green Emitter (single emitter)				
Wavelength of peak emission ($I_F = 20\text{ mA}$)	(typ.)	λ_{peak}	526	nm
Centroid Wavelength ($I_F = 20\text{ mA}$)	(typ. (max.))	$\lambda_{\text{centroid}}$	530 (± 10)	nm
Spectral bandwidth at 50% of I_{max} ($I_F = 20\text{ mA}$)	(typ.)	$\Delta\lambda$	32	nm
Half angle	(typ.)	φ	± 60	°
Rise and fall time of I_e (10% and 90% of $I_{e\text{max}}$) ($I_F = 100\text{ mA}$, $t_p = 16\text{ }\mu\text{s}$, $R_L = 50\text{ }\Omega$)	(typ.)	t_r, t_f	56	ns
Forward voltage ($I_F = 20\text{ mA}$)	(typ. (max.))	V_F	3.0 (≤ 3.4)	V
Reverse current ($V_R = 5\text{ V}$)		I_R	not designed for reverse operation	μA
Radiant intensity ($I_F = 20\text{ mA}$, $t_p = 20\text{ ms}$)	(typ.)	I_e	3.8	mW / sr
Total radiant flux ($I_F = 20\text{ mA}$, $t_p = 20\text{ ms}$)	(typ.)	Φ_e	11	mW
Temperature coefficient of I_e or Φ_e ($I_F = 20\text{ mA}$, $t_p = 20\text{ ms}$)	(typ.)	TC_I	-0.35	% / K
Temperature coefficient of $\lambda_{\text{centroid}}$ ($I_F = 20\text{ mA}$, $-10\text{ °C} \leq T \leq 100\text{ °C}$)	(typ.)	$TC_{\lambda_{\text{centroid}}}$	0.03	nm / K
Temperature coefficient of V_F ($I_F = 20\text{ mA}$, $-10\text{ °C} \leq T \leq 100\text{ °C}$)	(typ.)	TC_V	-3.6	mV / K

Characteristics ($T_A = 25\text{ °C}$)

Parameter		Symbol	Value	Unit
IR-Cut Detector				
Photocurrent ($E_e = 0.1\text{ mW/cm}^2$, $\lambda = 530\text{ nm}$, $V_R = 5\text{ V}$)	(typ.)	$I_{P,530}$	1.1	μA
Wavelength of max. sensitivity	(typ.)	$\lambda_{S\text{ max}}$	635	nm
Spectral range of sensitivity	(typ.)	$\lambda_{10\%}$	402 ... 694	nm
Radiation sensitive area	(typ.)	A	3.46	mm^2
Dimensions of radiant sensitive area	(typ.)	L x W	1.29 x 2.69	mm x mm
Half angle	(typ.)	φ	± 57	$^\circ$
Dark current ($V_R = 5\text{ V}$, $E_e = 0\text{ mW/cm}^2$)	(typ. (max.))	I_R	0.4 (≤ 2)	nA
Spectral sensitivity of the chip ($\lambda = 530\text{ nm}$)	(typ.)	$S_{\lambda 530}$	0.31	A / W
Spectral sensitivity of the chip ($\lambda > 690\text{ nm}$)	(typ.)	S_{IR}	0.02	A / W
Open-circuit voltage ($E_e = 0.1\text{ mW/cm}^2$, $\lambda = 530\text{ nm}$)	(typ.)	$V_{O,530}$	390	mV
Short-circuit current ($E_e = 0.1\text{ mW/cm}^2$, $\lambda = 530\text{ nm}$)	(typ.)	$I_{SC,530}$	1.1	μA
Rise and fall time ($V_R = 5\text{ V}$, $R_L = 50\ \Omega$, $\lambda = 530\text{ nm}$)	(typ.)	t_r, t_f	40	ns
Forward voltage ($I_F = 10\text{ mA}$, $E = 0\text{ mW/cm}^2$)	(typ.)	V_F	0.84	V
Capacitance ($V_R = 5\text{ V}$, $f = 1\text{ MHz}$, $E = 0\text{ mW/cm}^2$)	(typ.)	C_0	55	pF

Characteristics ($T_A = 25\text{ °C}$)

Parameter		Symbol	Value	Unit
Broadband Detector				
Photocurrent ($E_e = 0.1\text{ mW/cm}^2$, $\lambda = 530\text{ nm}$, $V_R = 5\text{ V}$)	(typ.)	$I_{P,530}$	0.4	μA
Photocurrent ($E_e = 0.1\text{ mW/cm}^2$, $\lambda = 655\text{ nm}$, $V_R = 5\text{ V}$)	(typ.)	$I_{P,655}$	0.6	μA
Photocurrent ($E_e = 0.1\text{ mW/cm}^2$, $\lambda = 940\text{ nm}$, $V_R = 5\text{ V}$)	(typ.)	$I_{P,940}$	1.1	μA
Wavelength of max. sensitivity	(typ.)	$\lambda_{S\text{ max}}$	960	nm
Spectral range of sensitivity	(typ.)	$\lambda_{10\%}$	410 ... 1100	nm
Radiation sensitive area	(typ.)	A	0.88	mm^2
Dimensions of radiant sensitive area	(typ.)	L x W	0.89 x 0.89	mm x mm
Half angle	(typ.)	φ	± 60	$^\circ$
Dark current ($V_R = 5\text{ V}$, $E_e = 0\text{ mW/cm}^2$)	(typ. (max.))	I_R	0.05 (≤ 10)	nA
Spectral sensitivity of the chip ($\lambda = 530\text{ nm}$)	(typ.)	$S_{\lambda 530}$	0.31	A / W
Spectral sensitivity of the chip ($\lambda = 655\text{ nm}$)	(typ.)	$S_{\lambda 655}$	0.56	A / W
Spectral sensitivity of the chip ($\lambda = 940\text{ nm}$)	(typ.)	$S_{\lambda 940}$	0.84	A / W
Open-circuit voltage ($E_e = 0.1\text{ mW/cm}^2$, $\lambda = 530\text{ nm}$)	(typ.)	$V_{O,530}$	211	mV
Short-circuit current ($E_e = 0.1\text{ mW/cm}^2$, $\lambda = 530\text{ nm}$)	(typ.)	$I_{SC,530}$	0.4	μA
Open-circuit voltage ($E_e = 0.1\text{ mW/cm}^2$, $\lambda = 655\text{ nm}$)	(typ.)	$V_{O,655}$	249	mV
Short-circuit current ($E_e = 0.1\text{ mW/cm}^2$, $\lambda = 655\text{ nm}$)	(typ.)	$I_{SC,655}$	0.6	μA
Open-circuit voltage ($E_e = 0.1\text{ mW/cm}^2$, $\lambda = 940\text{ nm}$)	(typ.)	$V_{O,940}$	266	mV
Short-circuit current ($E_e = 0.1\text{ mW/cm}^2$, $\lambda = 940\text{ nm}$)	(typ.)	$I_{SC,940}$	1.1	μA

Characteristics ($T_A = 25\text{ °C}$)

Parameter		Symbol	Value	Unit
Rise and fall time ($V_R = 5\text{V}$, $R_L = 50\ \Omega$, $\lambda = 940\text{ nm}$)	(typ.)	t_r, t_f	0.75	μs
Forward voltage ($I_F = 100\text{ mA}$, $E = 0\text{ mW/cm}^2$)	(typ.)	V_F	1.16	V
Capacitance ($V_R = 5\text{ V}$, $f = 1\text{ MHz}$, $E = 0\text{ mW/cm}^2$)	(typ.)	C_0	4.2	pF

Diagrams for infrared emitter**Relative spectral emission** ¹⁾

$$I_{\text{rel}} = f(\lambda), T_A = 25\text{ °C}, I_F = 20\text{ mA}$$

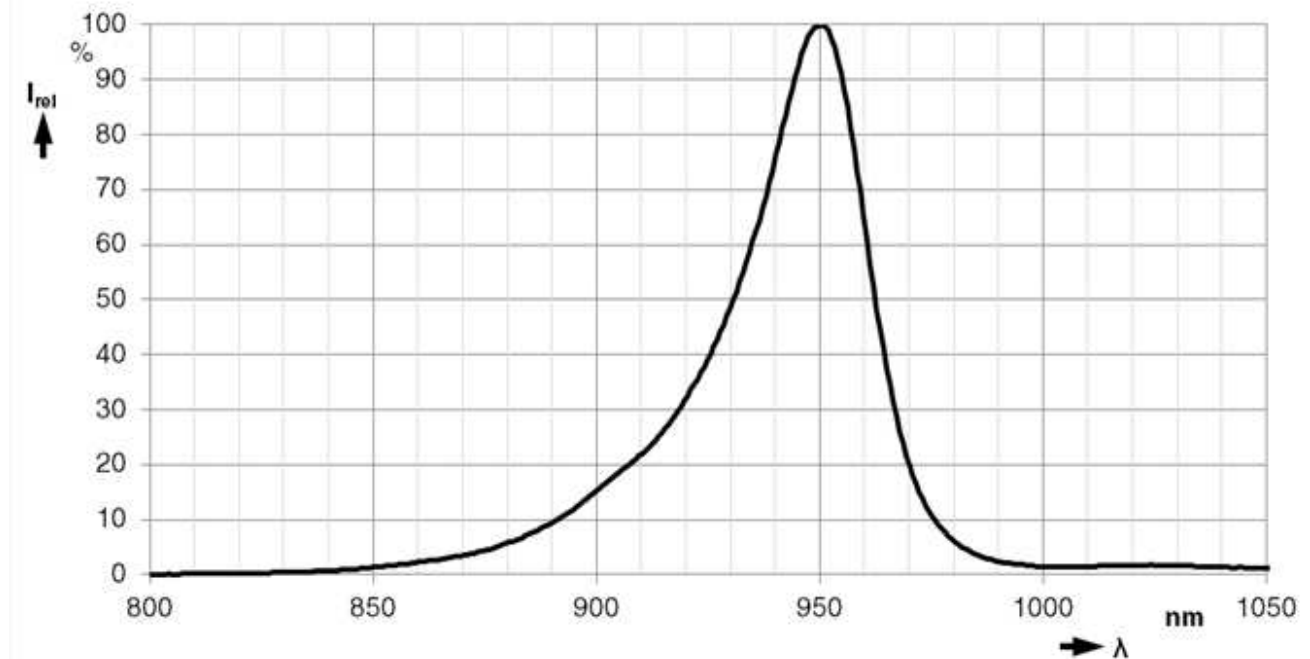

Diagrams for infrared emitter

Forward current ¹⁾

$I_F = f(V_F)$, single pulse, $t_p = 100 \mu s$, $T_A = 25^\circ C$

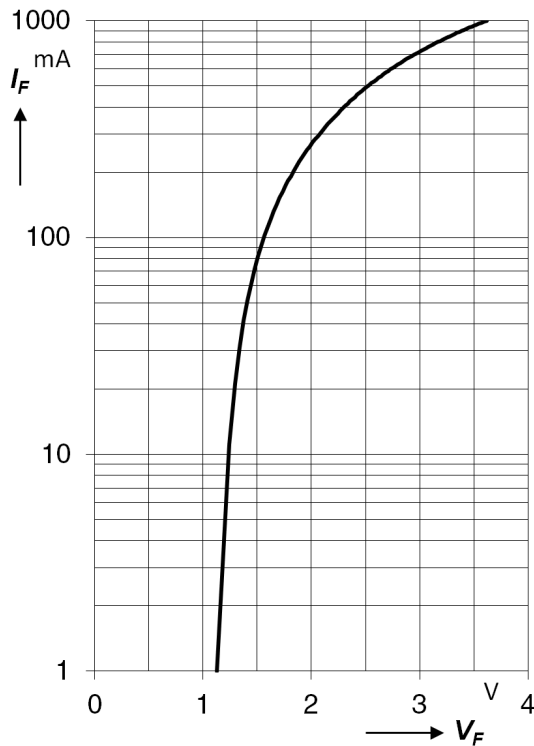

Relative radiant flux ¹⁾

$\Phi_e / \Phi_e(20 \text{ mA}) = f(I_F)$, single pulse, $t_p = 25 \mu s$, $T_A = 25^\circ C$

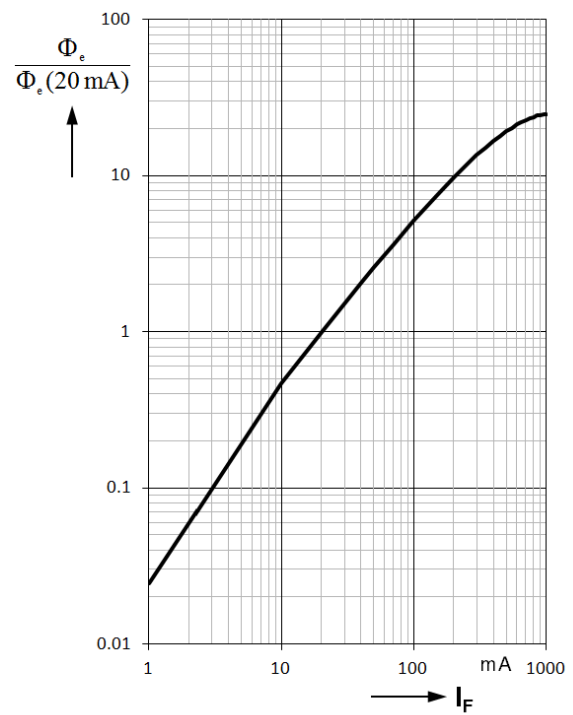

Max. permissible forward current ¹⁾

$I_{F,max} = f(T_A)$, $R_{thJA} = 800 \text{ K/W}$

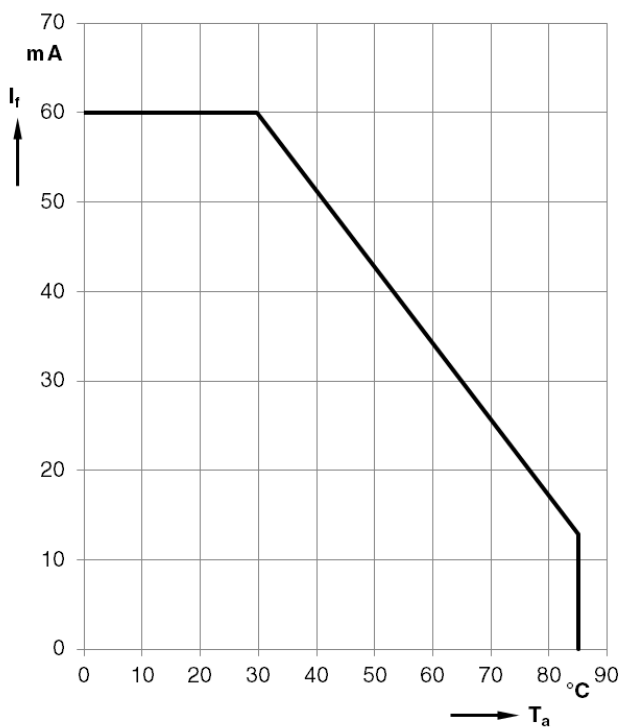

Diagrams for infrared emitter

Permissible pulse handling capability ¹⁾

$I_F = f(t_p)$, $T_A = 40^\circ\text{C}$, duty cycle $D = \text{parameter}$

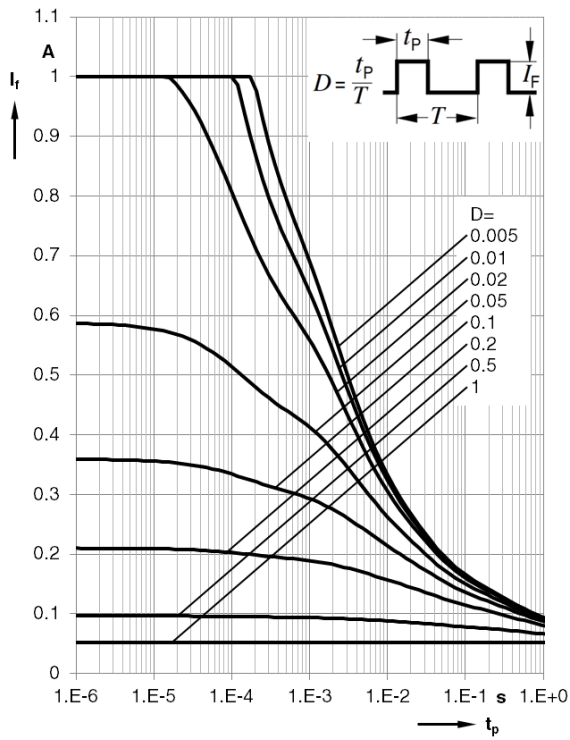

Permissible pulse handling capability ¹⁾

$I_F = f(t_p)$, $T_A = 85^\circ\text{C}$, duty cycle $D = \text{parameter}$

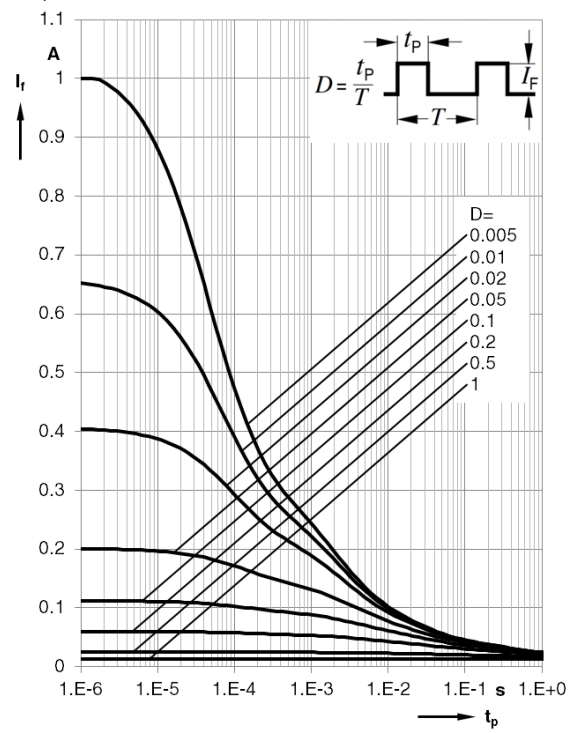

Diagrams for red emitter

Relative spectral emission ¹⁾

$I_{rel} = f(\lambda), T_A = 25\text{ }^\circ\text{C}, I_F = 20\text{ mA}$

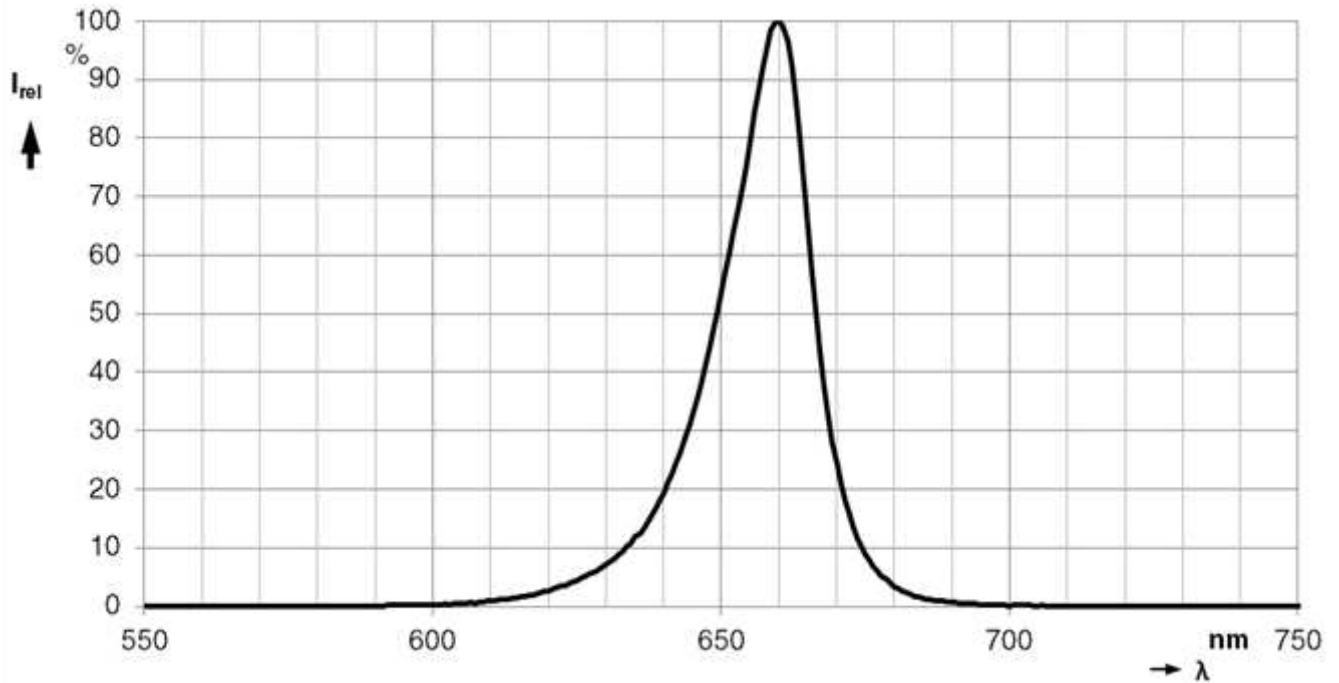

Forward current ¹⁾

$I_F = f(V_F), T_A = 25\text{ }^\circ\text{C}$

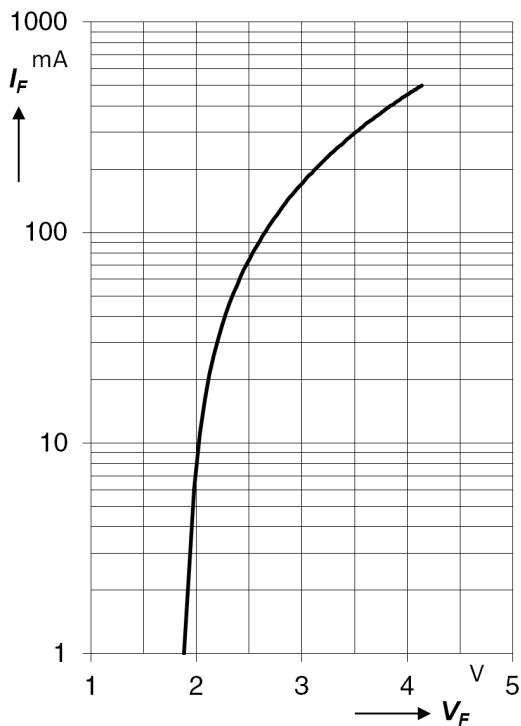

Relative radiant flux ¹⁾

$\Phi_e / \Phi_e(20\text{ mA}) = f(I_F), \text{ single pulse, } t_p = 25\mu\text{s}, T_A = 25\text{ }^\circ\text{C}$

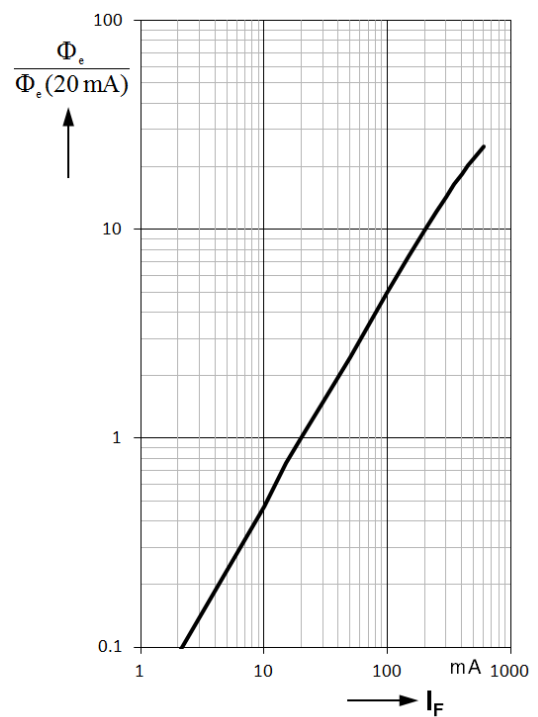

Diagrams for red emitter

Max. permissible forward current ¹⁾

$I_{F,max} = f(T_A), R_{thJA} = 800 \text{ K/W}$

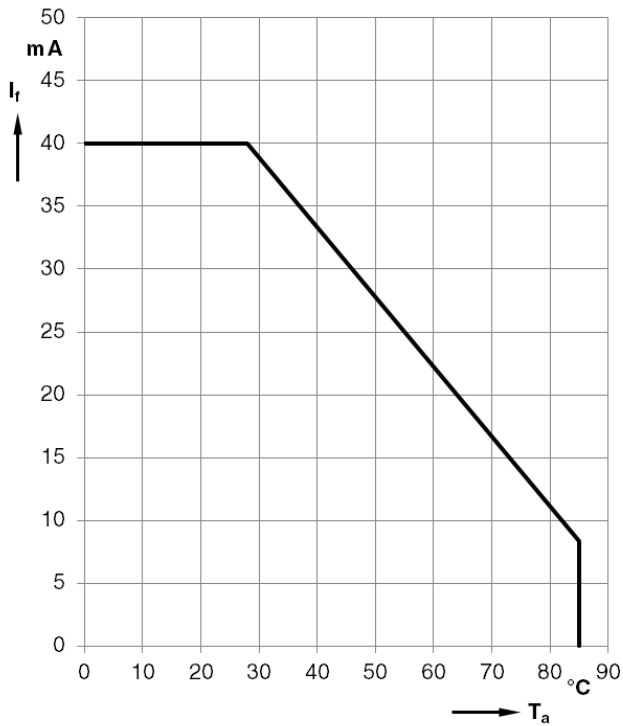

Permissible pulse handling capability ¹⁾

$I_F = f(t_p), T_A = 40^\circ\text{C}, \text{duty cycle } D = \text{parameter}$

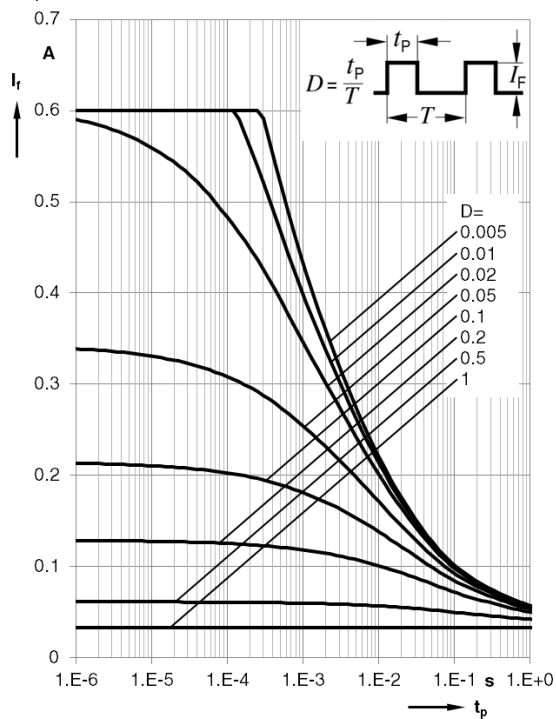

Permissible pulse handling capability ¹⁾

$I_F = f(t_p), T_A = 85^\circ\text{C}, \text{duty cycle } D = \text{parameter}$

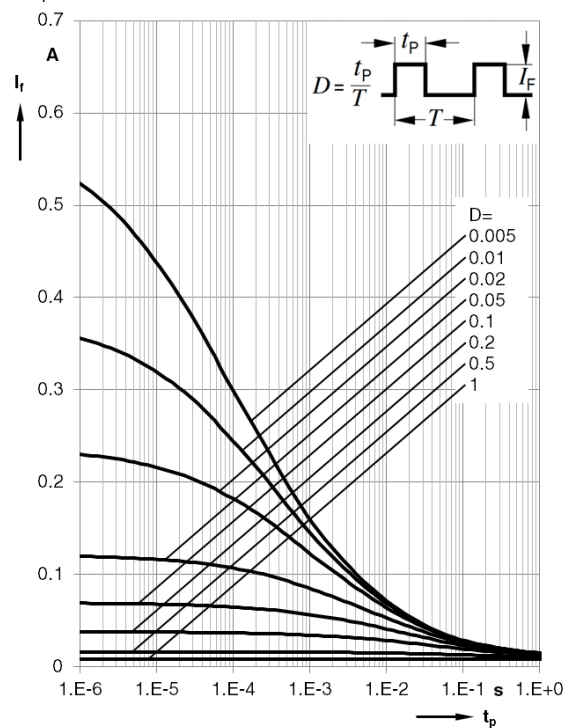

Diagrams for green emitters

Relative spectral emission ¹⁾

$I_{rel} = f(\lambda), T_A = 25\text{ }^\circ\text{C}, I_F = 20\text{ mA}$

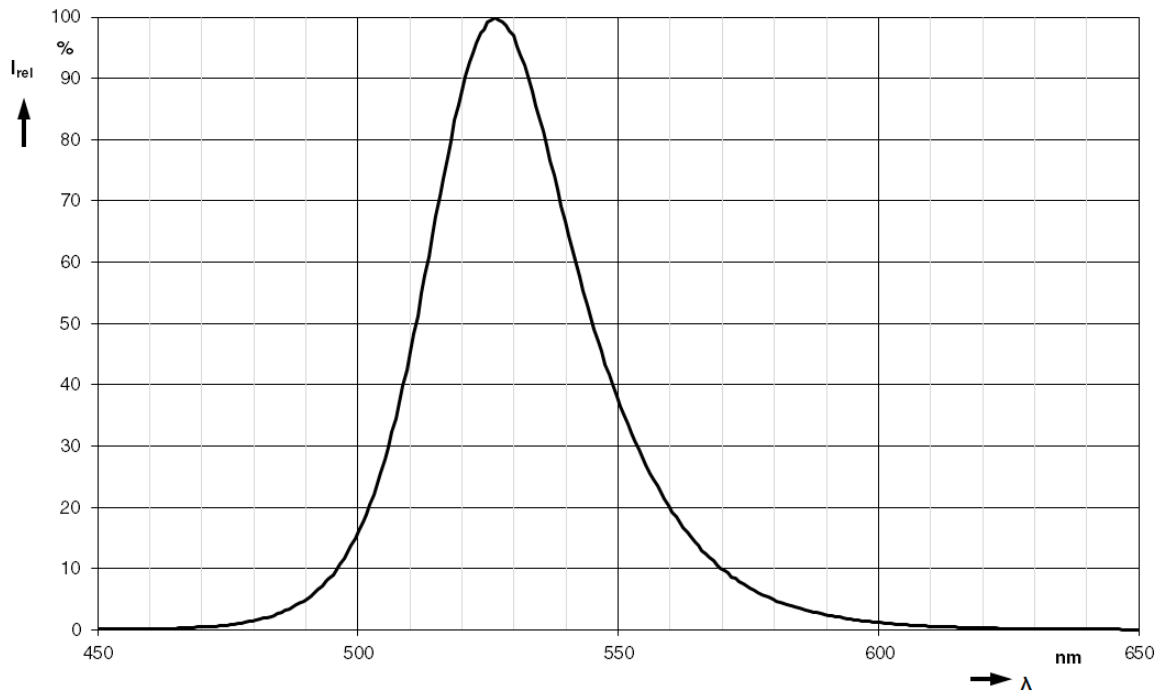

Forward current ¹⁾

$I_F = f(V_F), T_A = 25\text{ }^\circ\text{C}$

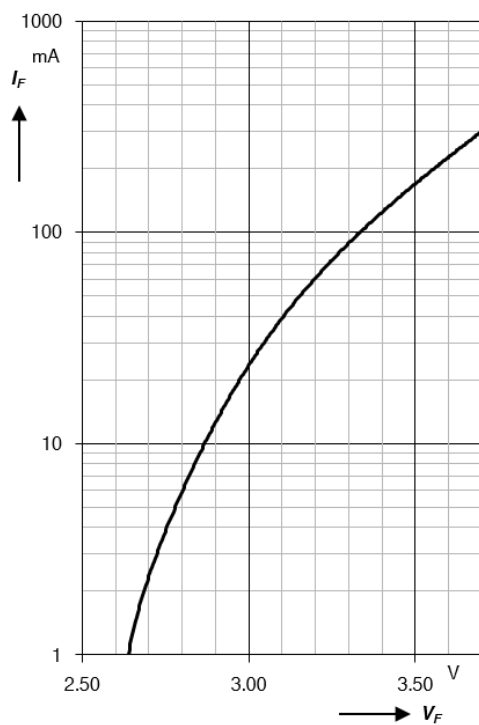

Relative radiant flux ¹⁾

$\Phi_e / \Phi_e(20\text{ mA}) = f(I_F), \text{ single pulse, } t_p = 25\mu\text{s}, T_A = 25\text{ }^\circ\text{C}$

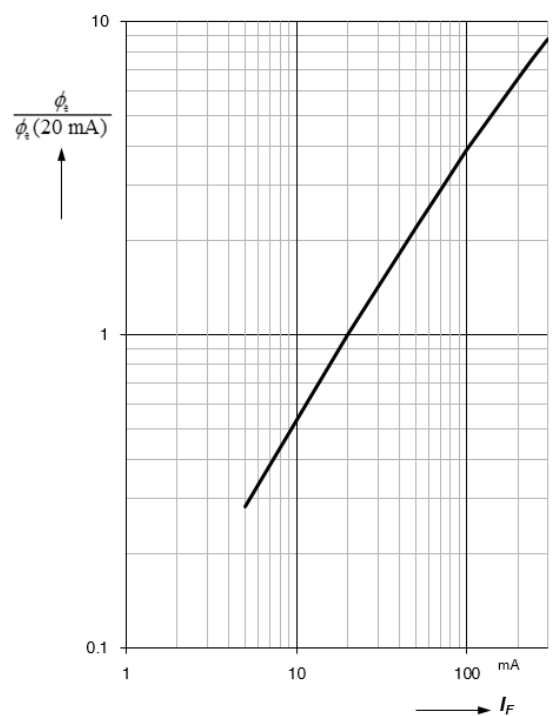

Diagrams for green emitters

Max. permissible forward current ¹⁾

$I_{F,max} = f(T_A), R_{thJA} = 800 \text{ K/W}$

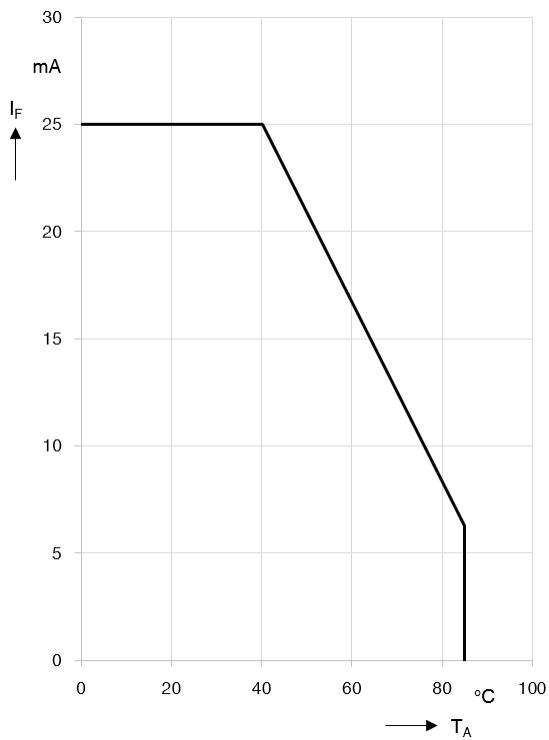

Permissible pulse handling capability ¹⁾

$I_F = f(t_p), T_A = 40^\circ\text{C}, \text{ duty cycle } D$

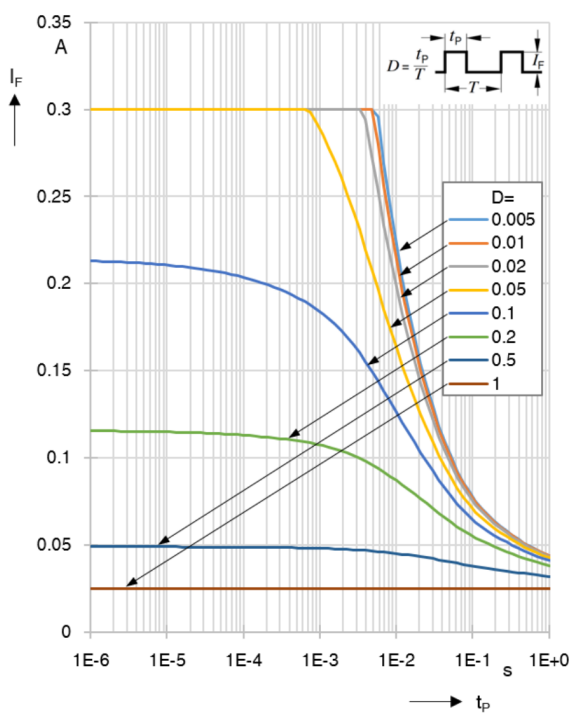

Permissible pulse handling capability ¹⁾

$I_F = f(t_p), T_A = 85^\circ\text{C}, \text{ duty cycle } D$

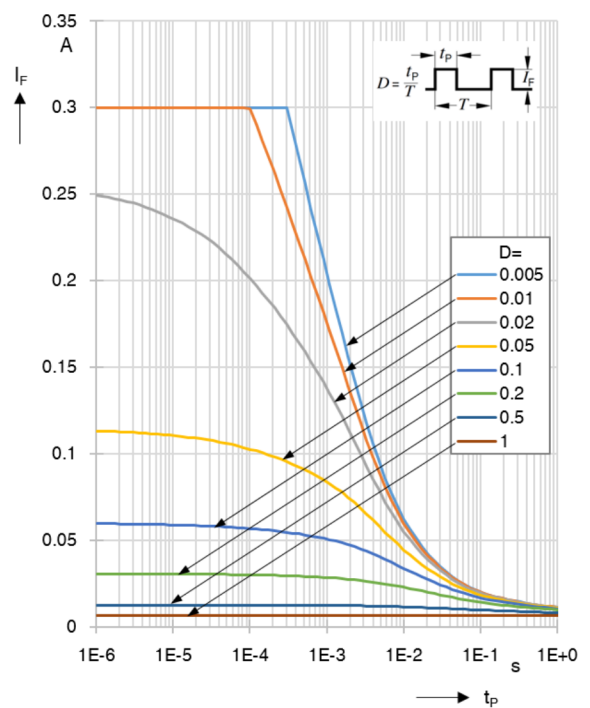

Diagrams for IR-Cut detector

Relative spectral sensitivity ¹⁾

$S_{rel} = f(\lambda), T_A = 25\text{ °C}$

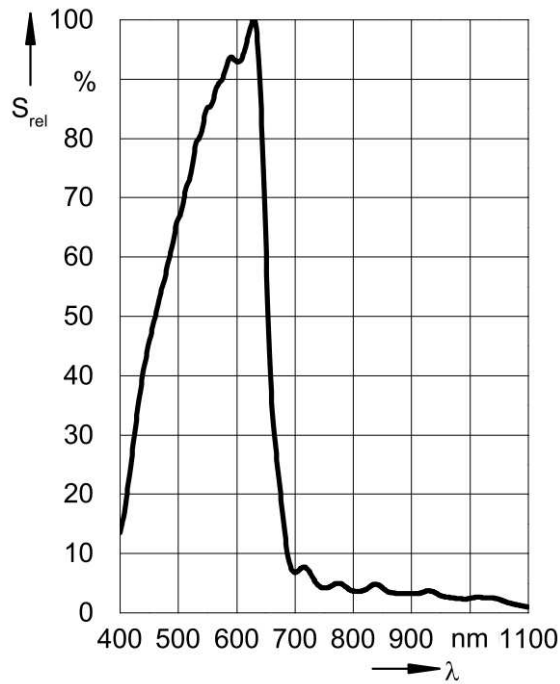

Photocurrent ¹⁾

$I_P(V_R = 5\text{ V}), \lambda = 530\text{ nm}, T_A = 25\text{ °C}$

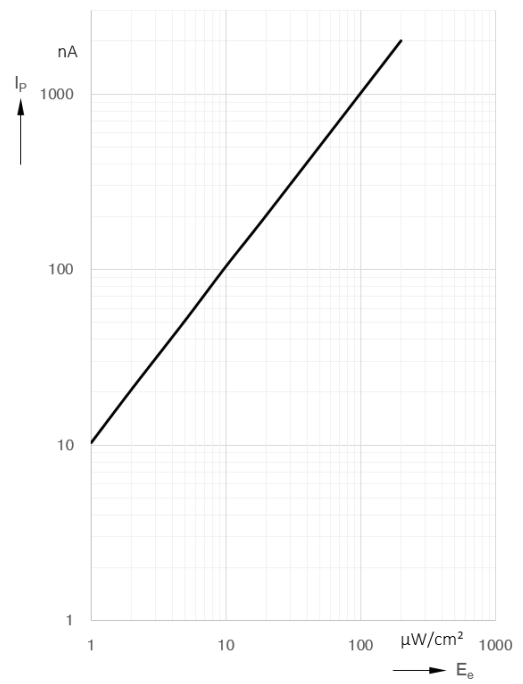

Dark current ¹⁾

$I_R = f(V_R), E = 0\text{ mW/cm}^2, T_A = 25\text{ °C}$

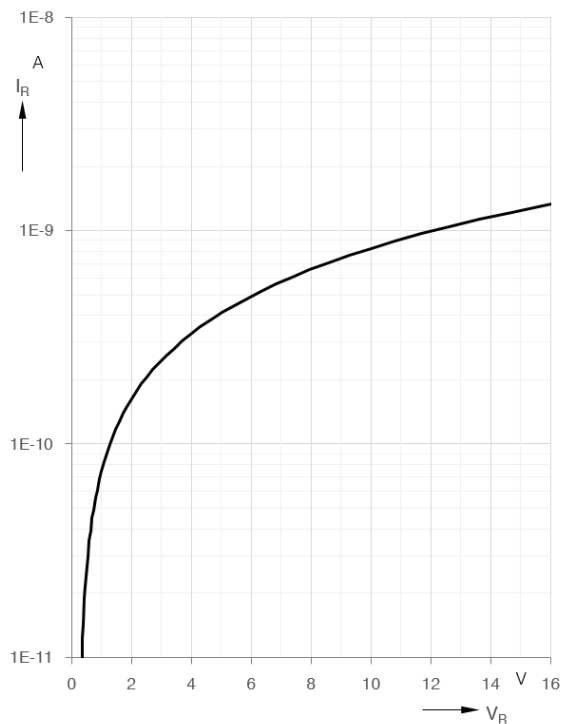

Capacitance ¹⁾

$C = f(V_R), f = 1\text{ MHz}, E = 0\text{ mW/cm}^2, T_A = 25\text{ °C}$

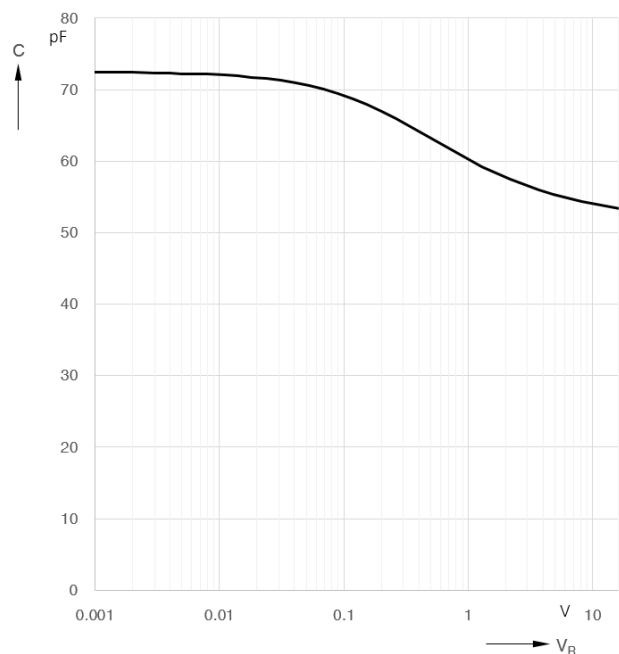

Diagrams for broadband detector

Relative spectral sensitivity ¹⁾

$S_{rel} = f(\lambda), T_A = 25\text{ °C}$

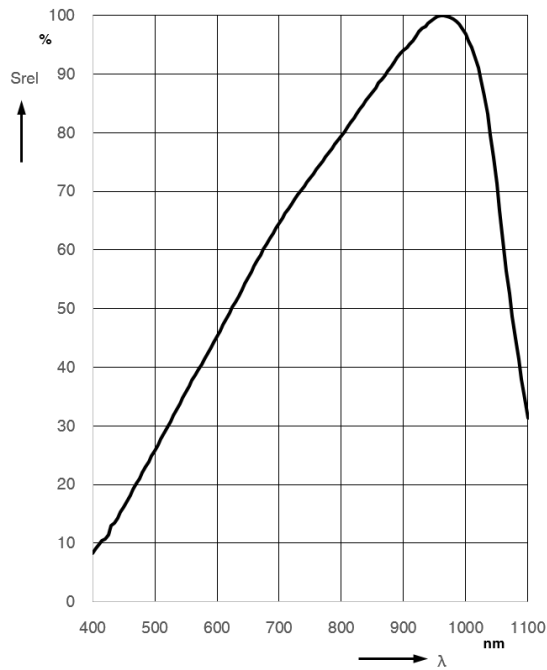

Photocurrent ¹⁾

$I_P(V_R = 5\text{ V}), \lambda = 530, 655, 940\text{ nm}, T_A = 25\text{ °C}$

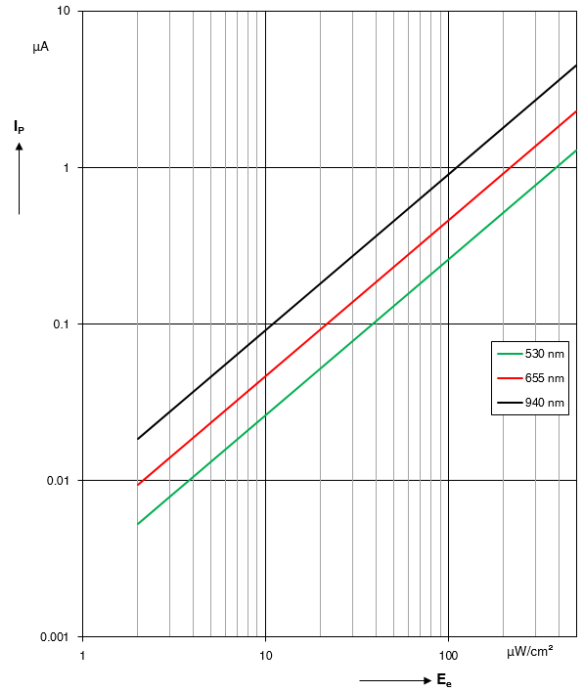

Dark current ¹⁾

$I_R = f(V_R), E = 0\text{ mW/cm}^2, T_A = 25\text{ °C}$

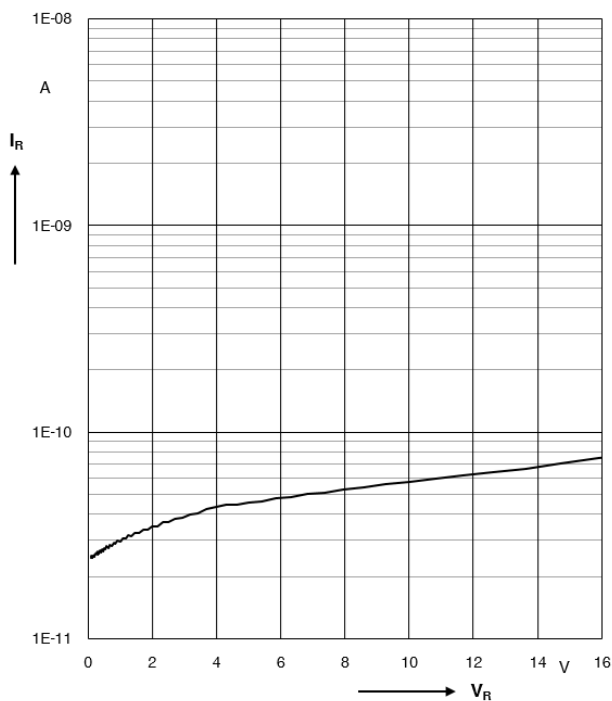

Capacitance ¹⁾

$C = f(V_R), f = 1\text{ MHz}, E = 0\text{ mW/cm}^2, T_A = 25\text{ °C}$

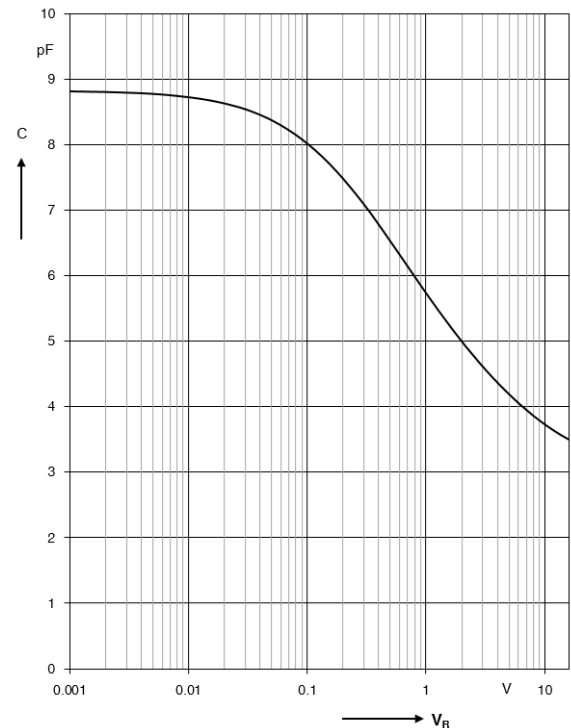

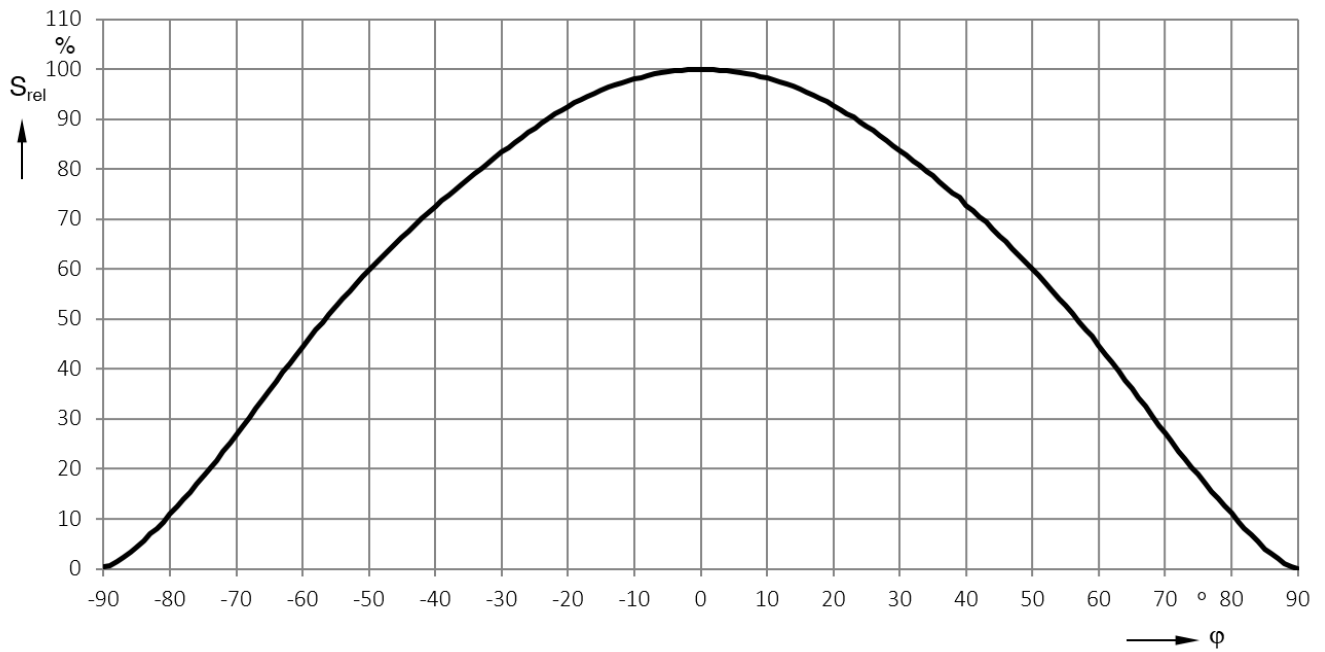
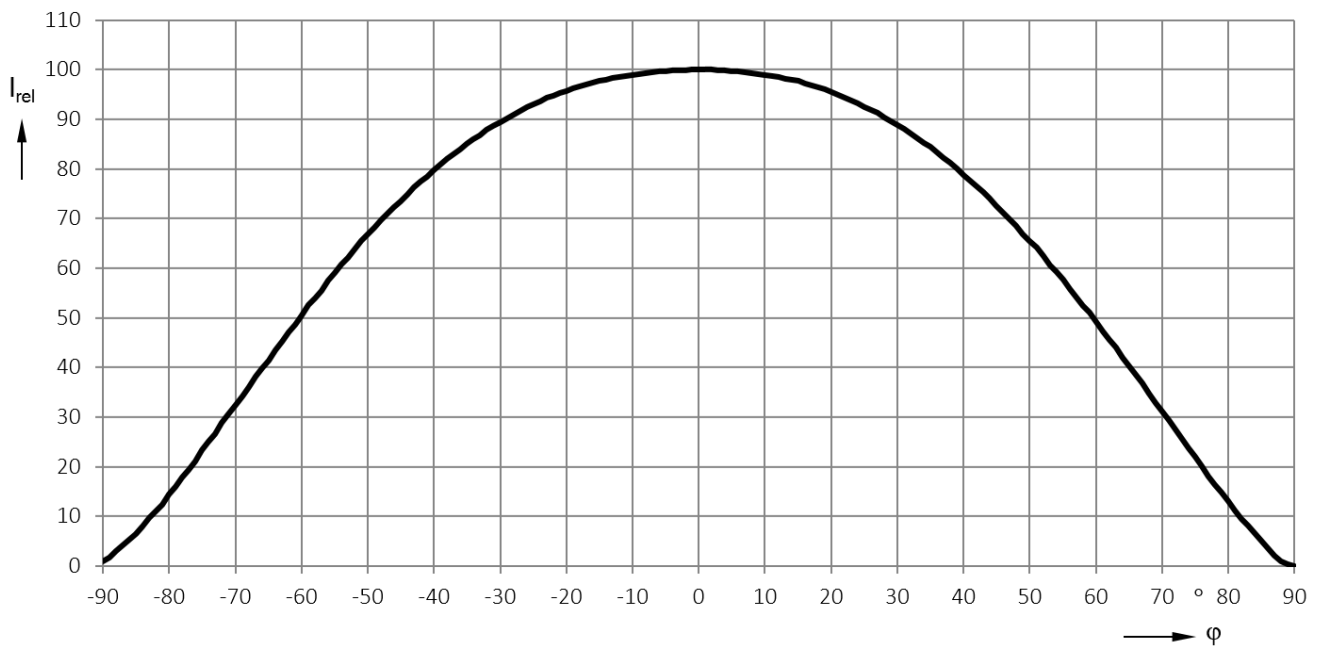
Directional characteristics of detectors ¹⁾ $S_{rel} = f(j)$, $\lambda = 530\text{nm}$ **Radiation characteristics of emitters ¹⁾** $I_{rel} = f(j)$ 

Package Outline

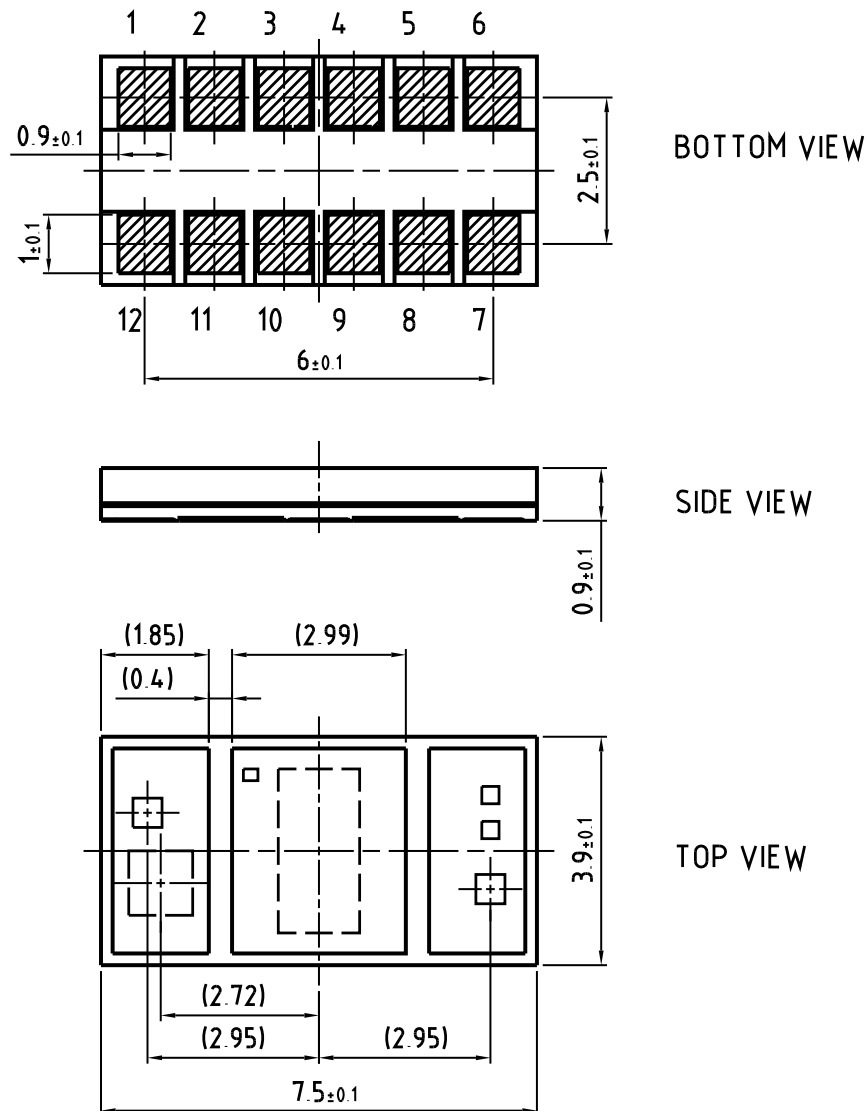

Pin	Name	Function
1	BPC	Broadband photodiode cathode
2	BPA	Broadband photodiode anode
3	IPC	IR-Cut photodiode cathode
4	IA	Infrared LED anode
5	G1A	Green LED 1 anode
6	G1C	Green LED 1 cathode
7	RA	Red LED anode
8	RC	Red LED cathode
9	IC	Infrared LED cathode
10	IPA	IR-Cut photodiode anode
11	G2A	Green LED 2 anode
12	G2C	Green LED 2 cathode

Dimensions in mm

Package:
chip on board

Approximate Weight:
44 mg

C63062-A4325-A1-01

Recommended solder pad design

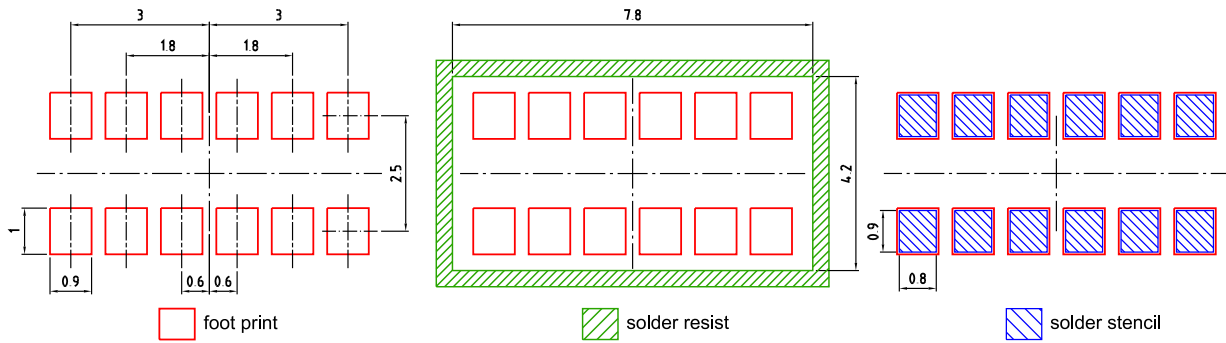

Component Location on Pad

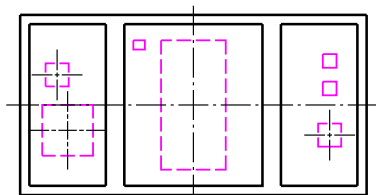

E062.3010.217-01

Dimensions in mm.

Reflow Soldering Profile

Product complies to MSL Level 4 acc. to JEDEC J-STD-020D.01

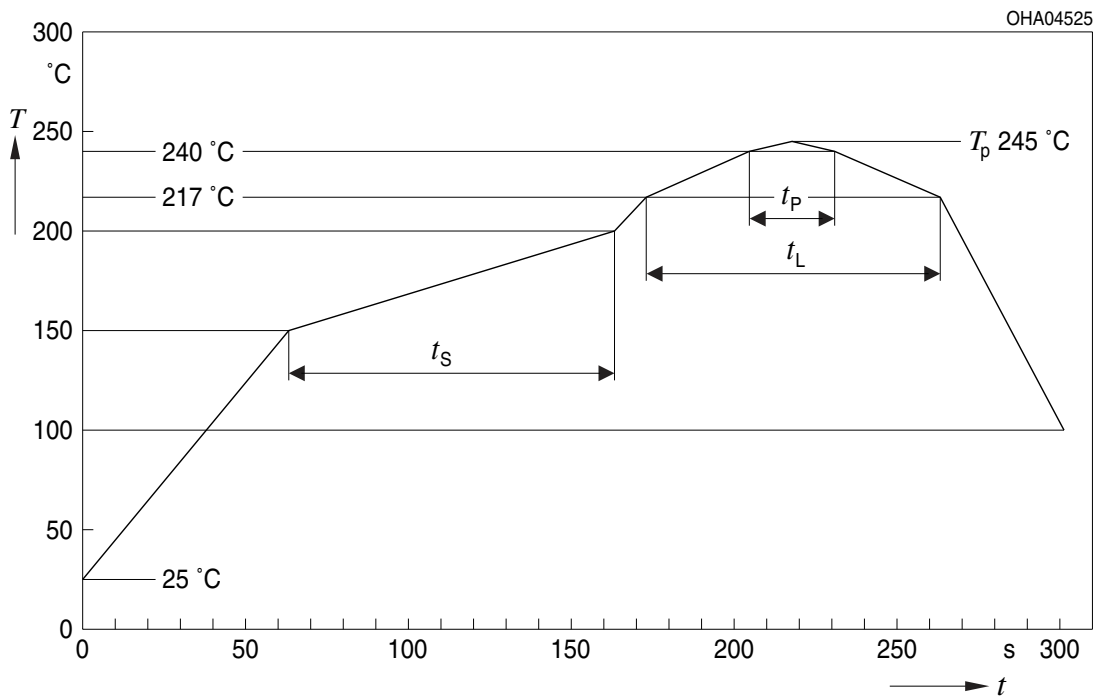

OH

Profil-Charakteristik Profile Feature	Symbol Symbol	Pb-Free (SnAgCu) Assembly			Einl Unit
		Minimum	Recommendation	Maximum	
Ramp-up Rate to Preheat*) 25 °C to 150 °C			2	3	K/s
Time t_S T_{Smin} to T_{Smax}	t_S	60	100	120	s
Ramp-up Rate to Peak*) T_{Smax} to T_P			2	3	K/s
Liquidus Temperature	T_L		217		°C
Time above Liquidus temperature	t_L		80	100	s
Peak Temperature	T_P		245	260	°C
Time within 5 °C of the specified peak temperature $T_P - 5$ K	t_p	10	20	30	s
Ramp-down Rate*) T_P to 100 °C			3	6	K/s
Time 25 °C to T_P				480	s

Method of Taping

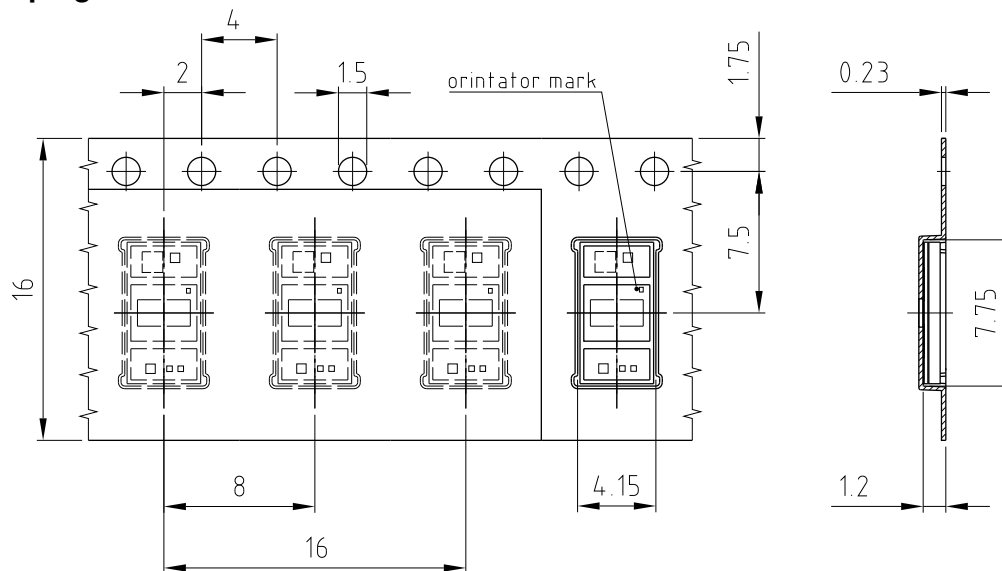

Dimensions in mm.

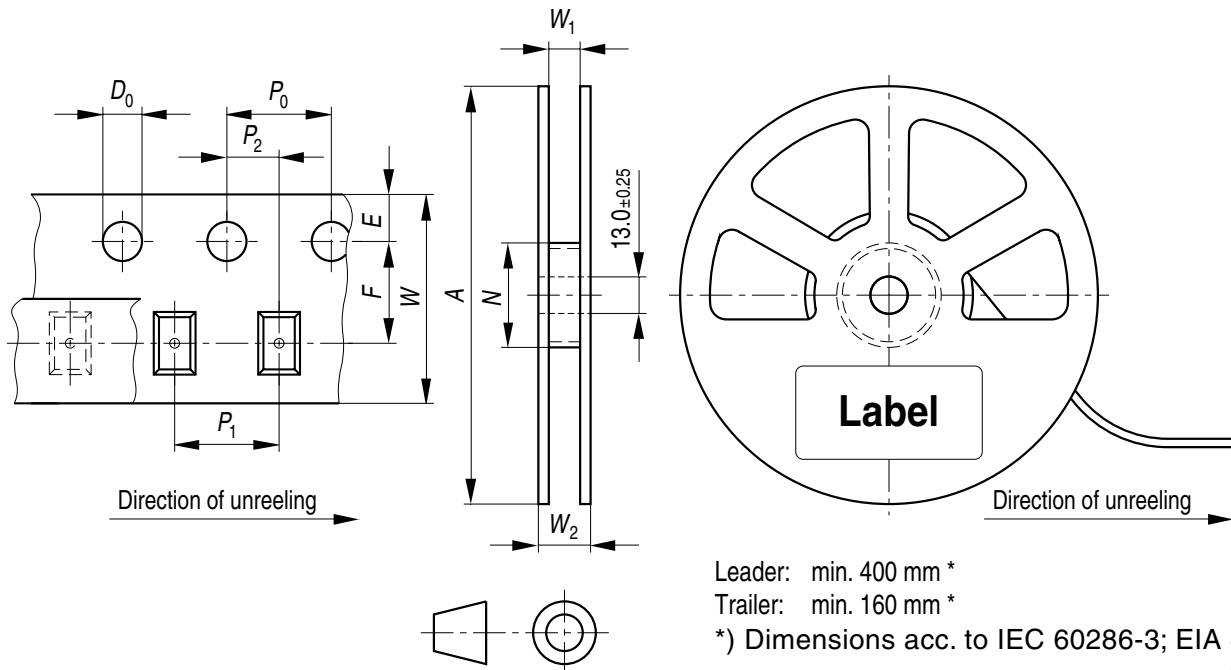
Tape and Reel16 mm tape with 1500 pcs. on \varnothing 180 mm reel*Dimensions in mm***Tape Dimensions [mm]**

W	P ₀	P ₁	P ₂	D ₀	E	F
16 +0.3 / -0.1	4 ±0.1	8 ±0.1	2 ±0.05	1.5 ±0.1	1.75 ±0.1	7.5 ±0.05

Reel Dimensions [mm]

A	W	N _{min}	W ₁	W _{2max}
180	16	60	16.4 +2	22.4

Barcode-Product-Label (BPL)

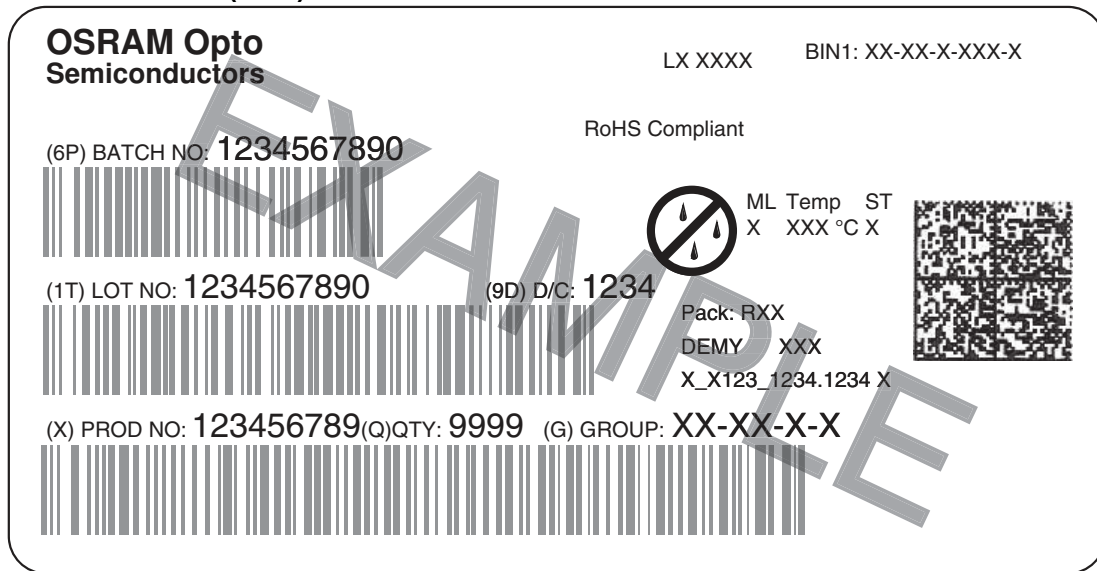

OHA04563

Dry Packing Process and Materials

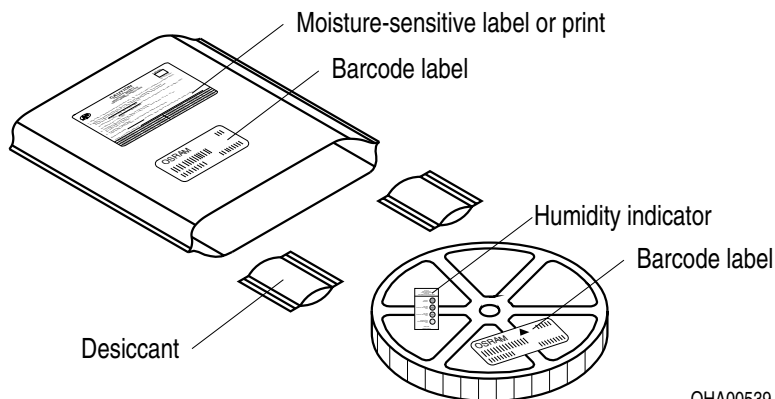

Note:

Moisture-sensitive product is packed in a dry bag containing desiccant and a humidity card. Regarding dry pack you will find further information in the internet. Here you will also find the normative references like JEDEC.

Disclaimer

Language english will prevail in case of any discrepancies or deviations between the two language wordings.

Attention please!

The information describes the type of component and shall not be considered as assured characteristics.

Terms of delivery and rights to change design reserved. Due to technical requirements components may contain dangerous substances.

For information on the types in question please contact our Sales Organization.

If printed or downloaded, please find the latest version on the OSRAM OS website.

Packing

Please use the recycling operators known to you. We can also help you – get in touch with your nearest sales office. By agreement we will take packing material back, if it is sorted. You must bear the costs of transport. For packing material that is returned to us unsorted or which we are not obliged to accept, we shall have to invoice you for any costs incurred.

Product and functional safety devices/applications or medical devices/applications

OSRAM OS components are not developed, constructed or tested for the application as safety relevant component or for the application in medical devices.

OSRAM OS products are not qualified at module and system level for such application.

In case Buyer – or Customer supplied by Buyer – considers using OSRAM OS components in product safety devices/applications or medical devices/applications, Buyer and/or Customer has to inform the local sales Partner of OSRAM OS immediately and OSRAM OS and Buyer and /or Customer will analyse and coordinate the customer-specific request between OSRAM OS and Buyer and/or Customer.

Glossary

¹⁾ **Typical Values:** Due to the special conditions of the manufacturing processes of LED and photodiodes, the typical data or calculated correlations of technical parameters can only reflect statistical figures. These do not necessarily correspond to the actual parameters of each single product, which could differ from the typical data and calculated correlations or the typical characteristic line. If requested, e.g. because of technical improvements, these typ. data will be changed without any further notice.

Published by OSRAM Opto Semiconductors GmbH
Leibnizstraße 4, D-93055 Regensburg
www.osram-os.com © All Rights Reserved.

EU RoHS and China RoHS compliant product



此产品符合欧盟 RoHS 指令的要求；
按照中国的相关法规和标准，不含有毒有害物质或元素。