

MATERIAL

- Cover: polyamide based (PA) technopolymer, black colour, semi-matte finish.
- Threaded connector: acetal based technopolymer (POM), black colour, semi-matte finish.

PACKING RINGS

NBR synthetic rubber O-Ring.

AIR FILTER

Polyurethane foam mesh "tech-foam" (polyester base), air filtration 10 µ.

MAXIMUM CONTINUOUS WORKING TEMPERATURE

80°C.

FEATURES AND APPLICATIONS

The cover of the SFC. breather cap (ELESA Patent) can be positioned in two different ways:

- Breather position: air is let in and out of the reservoir in normal conditions of use.
- Closure position: a packing ring between the cover and the threaded connector flange guarantees a perfect sealing of gas or liquid contained in the reservoir.

SPECIAL EXECUTIONS ON REQUEST

- Air filter in polyurethane foam mesh "tech-foam" (polyester base) with air filtration 40 µ.
- Cover in RAL 2004 orange.



ELESA Original design

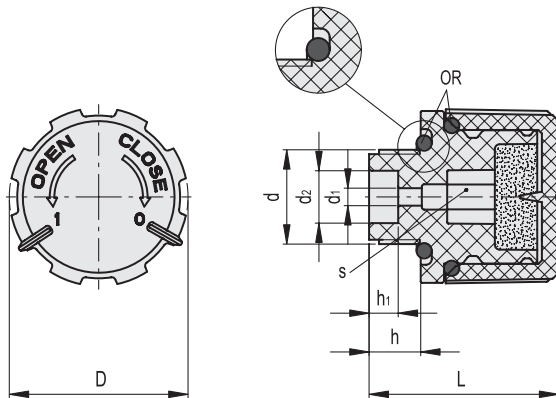

Conversion Table	
1 mm = 0.039 inch	
D	
mm	inch
30	1.18

BSP

METRIC

Code	Description	d	D	L	d1	d2	h	h1	s	⚖️
52801	SFC.30-3/8+F	G 3/8	30	33	3	9	9	5	8	18

ASSEMBLY INSTRUCTIONS

The components are supplied not assembled.

- Screw the threaded connector by means of a hexagon socket, tightening torque 8 Nm (fig. 1).
- Insert the "tech-foam" filter in its proper upper housing.
- Fit the cover on the threaded connector by properly matching the two different teeth (one large and one tight) inside the cover, with the relevant knurlings on the upper part of the threaded connector (fig. 2).
- By turning the cover clockwise of a few degrees the breather position is reached: the index on the cover marked with 1 is in line with the index of the threaded connector (fig. 3).
- By further turning the cover clockwise following the CLOSE arrow, the closure position is reached: the index on the cover marked with 0 is in line with the index of the threaded connector (fig. 4).
- To reach from the closure position to the breather one just turn the cover anticlockwise following the OPEN arrow until the click.
- By further turning the cover anticlockwise following the OPEN arrow, it is possible to remove the cover from the threaded connector, thus allowing the operator to clean the two components or to substitute or clean the "tech-foam" filter (fig. 5).

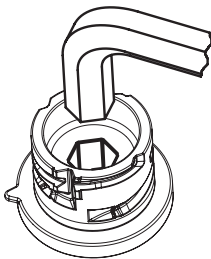
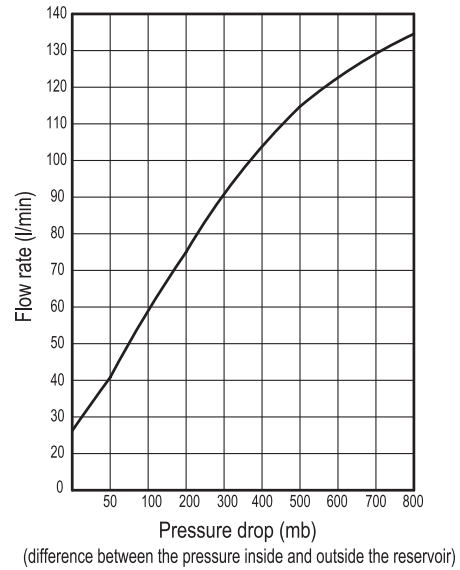

Fig.1

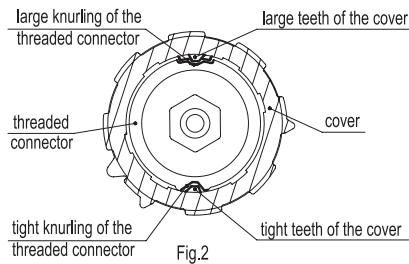

Fig.2

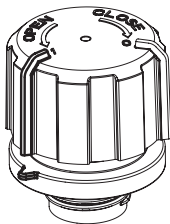

Fig.3

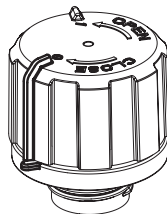

Fig.4

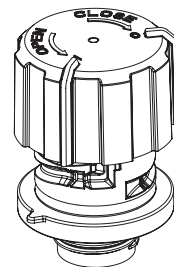

Fig.5

