



SE520X Series
Industrial Device Server Series

User Manual

V1.2

August 22nd, 2019

This PDF Document contains internal hyperlinks for ease of navigation.
For example, click on any item listed in the [Table of Contents](#) to go to that page.

Published by:**Atop Technologies, Inc.**

2F, No. 146, Sec. 1, Tung-Hsing Rd,
30261 Chupei City,
Hsinchu County
Taiwan, R.O.C.

Tel: +886-3-550-8137
Fax: +886-3-550-8131
sales@atop.com.tw
www.atoponline.com
www.atop.com.tw

Important Announcement

The information contained in this document is the property of Atop technologies, Inc., and is supplied for the sole purpose of operation and maintenance of Atop Technologies, Inc., products.

No part of this publication is to be used for any other purposes, and it is not to be reproduced, copied, disclosed, transmitted, stored in a retrieval system, or translated into any human or computer language, in any form, by any means, in whole or in part, without the prior explicit written consent of Atop Technologies, Inc.,

Offenders will be held liable for damages and prosecution.

All rights, including rights created by patent grant or registration of a utility model or design, are reserved.

Disclaimer

We have checked the contents of this manual for agreement with the hardware and the software described. Since deviations cannot be precluded entirely, we cannot guarantee full agreement. However, the data in this manual is reviewed regularly and any necessary corrections will be included in subsequent editions.

Suggestions for improvement are welcome.

All other product's names referenced herein are registered trademarks of their respective companies.

Documentation Control

Author:	Saowanee Saewong
Revision:	1.2
Revision History:	Review
Creation Date:	8 October 2018
Last Revision Date:	22 August 2019
Product Reference:	SE520X Industrial Device Server Series User Manual
Document Status:	Released

Table of Contents

1	Preface	8
1.1	Purpose of the Manual	8
1.2	Who Should Use This User Manual	8
1.3	Supported Platform	8
1.4	Manufacturers' FCC Declaration of Conformity Statement	8
2	Introduction	9
2.1	Overview	9
2.2	Features	9
3	Getting Started	11
3.1	Packing List	11
3.2	Appearance, Front and Rear Panels	11
3.3	First Time Installation	13
3.4	Factory Default Settings	14
3.4.1	Network Default Settings	14
3.4.2	Other Default Settings	14
4	Configuration and Setup	15
4.1	Configuration of Network Parameters through Device Management Utility	15
4.2	Configuring through Web/CLI Interface	18
4.3	Configuring Automatic IP Assignment with DHCP	21
4.4	Web Overview	21
4.5	Wizard	22
4.6	Network Settings	27
4.7	Serial	28
4.7.1	COM Port Overview	29
4.7.2	COM Configuration	30
4.7.3	COM Configuration: Advanced Settings	31
4.8	SNMP/ALERT Settings	34
4.9	E-Mail Settings	36
4.10	Log Settings	38
4.10.1	System Log Settings	38
4.10.2	COM Log Settings	40
4.10.3	System Log	41
4.10.4	COM log	41
4.11	System Setup	43
4.11.1	Date/Time Settings	44
4.11.2	Admin Settings	45
4.11.3	Firmware Upgrade	46
4.11.4	Backup/Restore Configuration	46
4.11.5	Ping	48
4.12	Reboot	49
5	Link Modes and Applications	50
5.1	Link Mode Configuration	50
5.1.1	Link Mode: Configure as a TCP Server	51
5.1.2	Link Mode: Configure as a TCP Client	55
5.1.3	Link Mode: Configure in UDP	57
5.2	Link Mode Applications	60

5.2.1	TCP Server Application: Enable Virtual COM.....	60
5.2.2	TCP Server Application: Enable RFC 2217 through Virtual COM.....	60
5.2.3	TCP Client Application: Enable Virtual COM.....	61
5.2.4	TCP Client Application: Enable RFC 2217 through Virtual COM.....	61
5.2.5	TCP Server Application: Configure as a Pair Connection Master.....	62
5.2.6	TCP Client Application: Configure as a Pair Connection Slave	62
5.2.7	TCP Server Application: Enable Reverse Telnet	63
6	VCOM Installation & Troubleshooting	65
6.1	Enabling VCOM.....	65
6.1.1	VCOM driver setup	67
6.1.2	Limitation	68
6.1.3	Installation	68
6.1.4	Uninstallation.....	68
6.2	Enable VCOM in Serial Device servers and Select VCOM in Windows	68
6.2.1	Enable VCOM in Serial Device servers	68
6.2.2	Running Serial/IP Software Utility in Windows	69
6.2.3	Configuring VCOM Ports.....	71
6.3	Exceptions	75
6.4	Using Serial/IP Port Monitor.....	81
6.4.1	Opening the Port Monitor.....	81
6.4.2	The Activity Panel.....	81
6.4.3	The Trace Panel.....	82
6.5	Serial/IP Advanced Settings	84
6.5.1	Advanced Setting Options	84
6.5.2	Using Serial/IP with a Proxy Server	85
7	Specifications	86
7.1	Hardware.....	86
7.2	Serial port Pin Assignments	87
7.2.1	Pin Assignments for Serial Interfaces	87
7.3	LED Indicators	88
7.4	Software.....	88
8	Emergency System Recovery	89
8.1	System Recovery Procedures.....	89
9	Warranty	90

Table of Figures

Figure 2.1	An Application of SE5201 Industrial Serial Device Server with Multiple Devices	9
Figure 4.1	List of Device in Device Management Utility.....	15
Figure 4.2	Pull-down Menu of Configuration and Network.....	15
Figure 4.3	Pop-up Window of Network Setting	16
Figure 4.4	Authorization for Change of Network Settings.....	16
Figure 4.5	Pop-up Notification Window after Authorization	16
Figure 4.6	Pop-up Notification Window when there is the same IP address in the network.....	17
Figure 4.7	Authentication Required for Accessing Web Interface	18
Figure 4.8	Warning Pop-up Window for Changing or Resetting Password from Default Value	18

Figure 4.9 Overview Web Page of SE520X Industrial Serial Device Server.....	19
Figure 4.10 Map of Configuring Web Page on SE520X Industrial Serial Device Server.....	19
Figure 4.11 Access control.....	20
Figure 4.12 CLI interface.....	20
Figure 4.13 Overview Web Page.....	21
Figure 4.14 Step 1/6 – A Welcome Web Page to the Configuration Wizard.....	22
Figure 4.15 Step 2/6 – An Administration Web Page to Set Password.....	22
Figure 4.16 Step 3/6 – A Date/Time Web Page of the Configuration Wizard.....	23
Figure 4.17 Step 4/6 – Network Web Page to Set LAN's IP address.....	24
Figure 4.18 Step 5/6 – COM Web Page to Set COM Port.....	25
Figure 4.19 Step 6/6 – Final Web Page to Introduce Serial/IP utility.....	26
Figure 4.14 Network Settings Web Page.....	27
Figure 4.15 Serial Menu.....	28
Figure 4.16 COM 1 Port Settings Web Page.....	29
Figure 4.17 Serial Settings Part of COM 1 Port.....	30
Figure 4.18 COM 1 Advanced Settings Web Page.....	32
Figure 4.19 SNMP/Alert Settings Web Page.....	35
Figure 4.20 SNMP Version v1/v2c/v3 is enabled.....	36
Figure 4.21 E-mail Setting Web Page.....	37
Figure 4.22 Log Settings Menu.....	38
Figure 4.23 Log Settings Web Page under Log Settings.....	38
Figure 4.24 COM Log Settings Web Page under System Setup.....	40
Figure 4.25 System Log Web Page under System Setup.....	41
Figure 4.26 COM Datalog Web Page under Log Settings.....	42
Figure 4.27 System Setup Menu.....	43
Figure 4.28 Date/Time Settings Web Page under System Setup.....	44
Figure 4.29 Admin Settings Web Page under System Setup.....	45
Figure 4.30 Firmware Upgrade Web Page under System Setup.....	46
Figure 4.31 Backup/Restore Settings Web Page under System Setup.....	47
Figure 4.32 Ping Web Page under System Setup.....	48
Figure 4.33 Unreachable Ping Example.....	48
Figure 4.34 Reboot Web Page.....	49
Figure 5.1 Link Mode Options for COM1 Port.....	50
Figure 5.2 SE5201 is set as a TCP Server Link Mode.....	51
Figure 5.3 Connection Settings for TCP Server Link Mode.....	52
Figure 5.4 TCP Server Link Mode Settings under COM 1 Page.....	53
Figure 5.5 Example of SE5201 Configured as TCP Client Link Mode.....	55
Figure 5.6 Connection Settings for TCP Client Link Mode.....	56
Figure 5.7 Setting in TCP Client Link Mode.....	56
Figure 5.8 Example of SE520X Configured in UDP Link Mode.....	58
Figure 5.9 Connection Setting in UDP Link Mode.....	58
Figure 5.10 UPD Link Mode Setting under COM 1 Page.....	59
Figure 5.11 Virtual COM Application in TCP Server Link Mode.....	60
Figure 5.12 Virtual COM Application in TCP Client Link Mode.....	61
Figure 5.13 Pair Connection Master Application in TCP Server Link Mode.....	62
Figure 5.14 Pair Connection Slave Application in TCP Client Link Mode.....	63
Figure 5.15 Reverse Telnet Application in TCP Server Link Mode.....	64
Figure 6.1 Enable a Virtual COM Application When Setting the Link Mode as the TCP Server.....	65
Figure 6.2 Enable a Virtual COM Application When Setting the Link Mode as the TCP Client.....	66
Figure 6.3 An Example Diagram of Virtual COM Application over TCP/IP Network.....	67
Figure 6.4 Enable Virtual COM Application for COM 2 in TCP Server Link Mode.....	69
Figure 6.5 Serial/IP Tray Icon on Windows Notification Area.....	69
Figure 6.6 A Pop-up Window for Selecting Virtual COM Ports.....	70
Figure 6.7 Serial/IP Control Panel Window.....	71
Figure 6.8 Available Options for Use Credential From in Serial/IP Control Panel Version 4.9.10.....	72
Figure 6.9 Configuring Virtual COM 2 Port as TCP Client.....	73

Figure 6.10 Auto Configure (formerly Configuration Wizard) Window for COM 1	74
Figure 6.11 Timeout Warning on VCOM Connection	75
Figure 6.12 Error of Client not licensed for this server	76
Figure 6.13 Licensing Issue of Serial/IP Utility Software.....	77
Figure 6.14 VCOM Authentication failed due to Missing Username/Password	78
Figure 6.15 VCOM Authentication failed due to incorrect Username and/or Password	79
Figure 6.16 VCOM Authentication failed due to disabled VCOM Authentication	80
Figure 6.17 Activity Panel of Serial/IP Port Monitor	81
Figure 6.18 Trace Panel of Serial/IP Port Monitor	82
Figure 6.19 Serial/IP Advanced Settings Window	84
Figure 6.20 Proxy Server Tab under Serial/IP Advanced Settings	85
Figure 7.1 DB9 Pin Number	87
Figure 7.2 TB5 Pin Number.....	87

List of Tables

Table 3.1 Packing List.....	11
Table 3.2 Description of Optional Accessories	11
Table 3.3 Network Default Setting	14
Table 3.4 Security , Serial, and SNMP Default Settings	14
Table 7.1 Hardware Specification	86
Table 7.2 SE5201/SE5201C Pin Assignment for DB9 to RS-232/RS-422/RS-485 Connector.....	87
Table 7.3 SE5201/SE5201C Pin Assignment for TB5 to RS-232/RS-422/RS-485 Connector.....	88
Table 7.4 Color Interpretation of LED Indicators.....	88
Table 7.5 Software Tools and Utilities	88
Table 8.1 Default Settings for System Recovery Procedure.....	89

1 Preface

1.1 *Purpose of the Manual*

This manual supports the user during the installation and configuring of the SE520X SerialDevice Server Series. It explains the technical features available with the mentioned product. As such, it contains some advanced network management knowledge, instructions, examples, guidelines and general theories designed to help users manage this device and its corresponding software. A background in general theory is necessary when reading it. Please refer to the Glossary for technical terms and abbreviations (if any).

1.2 *Who Should Use This User Manual*

This manual is to be used by qualified network personnel or support technicians who are familiar with network operations. It might be useful for system programmers or network planners as well. This manual also provides helpful and handy information for first time users. For any related problems, please contact your local distributor. If they are unable to assist you, please redirect your inquiries to www.atoponline.com.

1.3 *Supported Platform*

This manual is designed for **SE520X Industrial Serial Device Server Series** and that series only.

1.4 *Manufacturers' FCC Declaration of Conformity Statement*

NOTE: This equipment has been tested and found to comply with the limits for a Class A digital device, pursuant to Part 15 of the FCC rules. These limits are designed to provide reasonable protection against harmful interference when the equipment is operated in a commercial environment. This equipment generates, uses, and can radiate radio frequency energy and, if not installed and used in accordance with the instruction manual, may cause harmful interference to radio communications. Operation of this equipment in a residential area is likely to cause harmful interference in which case the user will be required to correct the interference at his/her own expense.

This device complies with Part 15 of the FCC Rules.

Operation is subject to the following two conditions:

1. This device may not cause harmful interference, and
2. This device must accept any interference received, including interference that may cause an undesired operation.

Note: all the figures herein are intended for illustration purposes only. This software and certain features work only on certain Atop's devices.

2 Introduction

2.1 Overview

The SE520X is an entry-level industrial Ethernet serial device server which acts as a gateway for communications between Ethernet (TCP/UDP) port and one or two RS-232/RS-422/RS-485 ports. It is a compact and field-mount device with software-selectable serial port. The information conveyed by the SE520X model is transparent to both host computers (Ethernet) and serial devices (RS-232/RS-422/RS-485). Data coming from the Ethernet port is sent to the designated RS-232/RS-422/RS-485 port, and data received from RS-232/RS-422/RS-485 port is sent to the Ethernet port, allowing full-duplex and bi-directional communication. In the computer-aided manufacturing or industrial automation areas, field devices can directly connect to an Ethernet network via the SE520X model. In normal PCs or laptops, a virtual COM port can be created using our virtual COM software to fetch serial data from SE520X remotely over Ethernet.

With the SE520X model, it is possible to communicate with a remote serial device over the LAN or even over the Internet, which dramatically increases reachability and scalability.

Figure 2.1 illustrates an example of multiple devices connected to the Industrial Serial Device Server. A PC connects to the Industrial Serial Device Server via Ethernet interface, and a monitored device reports to Industrial Serial Device Server via RS-232/RS-422/RS-485 interface. It is possible to have multiple PCs connected into the same Industrial Serial Device Server through TCP or UDP transport protocols, as well as multiple monitored devices connected via RS-232/RS-422/RS-485 to Industrial Serial Device Server.

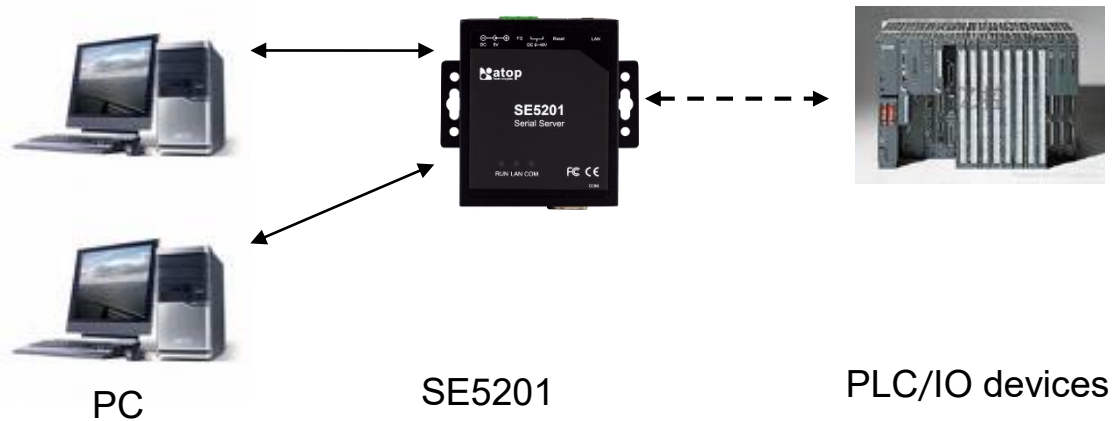

Figure 2.1 An Application of SE5201 Industrial Serial Device Server with Multiple Devices

2.2 Features

The SE520X Compact Field-Mount Serial Device Server Series share the same software platform on different available hardwares. It provides

- Flexible hardware platform (DB-9 or TB-5), software-selectable serial port (RS-232 or RS-422 or RS-485) based on your needs
- TCP Server/Client, UDP, Virtual COM and Tunneling modes supported
- Remotely monitor, manage, and control industrial field devices

- Configuration via Web Browser/ Serial Console/ Telnet Console/ Atop's Windows Utility (Device Management Utility)
- Rugged metal housing with IP30 protection for wall or optional DIN-Rail mount
- Wide range power supply input either 5 VDC (DC Jack) or between 9 – 30 VDC (Terminal Block)

Caution

Beginning from here, extreme caution must be exercised.



Never install or work with electricity or cabling during periods of lightning activity. Never connect or disconnect power when hazardous gases are present.



Warning: HOT!

WARNING: Disconnect the power and allow unit to cool for 5 minutes before touching.

3 Getting Started

3.1 Packing List

Inside the purchased package, you will find the following items.

Table 3.1 Packing List

Item	Quantity	Description
SE520X	1	Serial Device Server
Mounting Kit	1	Wall mount screws (x 2)
Terminal Block		Power Supply: <ul style="list-style-type: none"> • TB3 x 1: 3-pin 5.08mm lockable Terminal Block (SE5201, SE5202 only) Serial ports: Terminal block is included only on TB model <ul style="list-style-type: none"> • TB5 x 1: 5-pin 5.08mm lockable Terminal Block (SE5201-TB, SE5202-TB-X, SE5201C-TB)
Documentation	1	Hardware Installation Guide (Warranty card is included)

Note:

- Notify your sales representative immediately if any of the above items is missing or damaged upon delivery.
- ATOP's utility software Device View® and Serial Manager® are obsolete and replaced by Device Management Utility.

Table 3.2 Description of Optional Accessories

Optional Accessories		
Model Name	Part Number	Description
DK-25	30200000000022G	Plastic DIN Rail Kit
ADP-DB9(F)-TB5	59906231G	Female DB9 to Female 3.81mm, a TB5 Converter
UN315-1212(US-Y)	50500151120003G	Y-Type power adaptor, 100~240VAC input, 1.25A @ 12VDC output, US plug, LV6
UNE315-1212(EU-Y)	50500151120013G	Y-Type power adaptor, 100~240VAC input, 1.25A @ 12VDC output, EU plug, LV6
UV305-0510(US-DC)	50500051500003G	DC jack (3.5/1.35/7.5 mm) power adapter, 100~240VAC input, 1.0A@ 5VDC output, US plug, LV6
UVE305-0510(EU-DC)	50500051500013G	DC jack (3.5/1.35/7.5 mm) power adapter, 100~240VAC input, 1.0A@ 5VDC output, EU plug, LV6
UVE305-0510(UK-DC)	50500051500023G	DC jack (3.5/1.35/7.5 mm) power adapter, 100~240VAC input, 1.0A@ 5VDC output, UK plug, LV6

3.2 Appearance, Front and Rear Panels

The following figures show particular SE520X series device's front, back, side and top panels.

SE5201C – Entry-Level Semi-industrial Serial Device Server

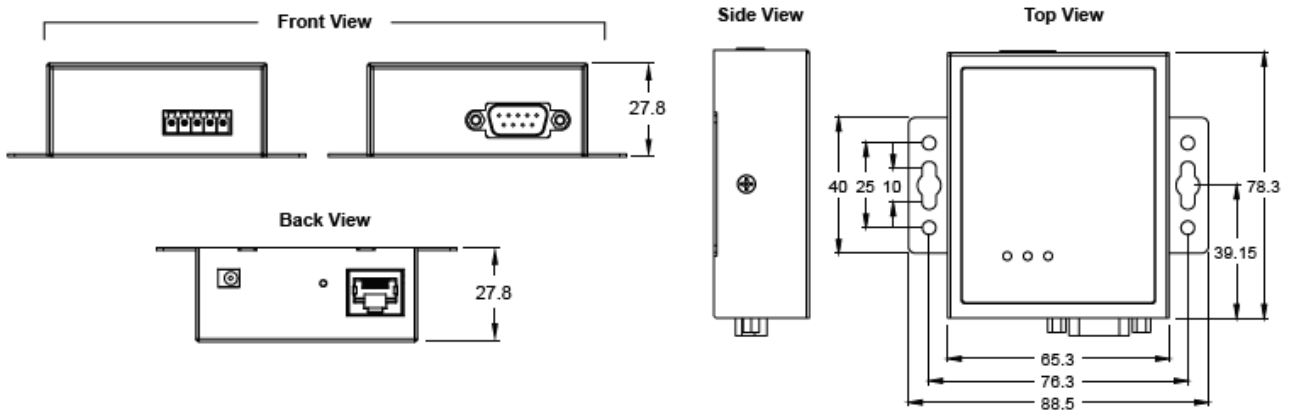

SE5201 – Industrial 1-Port Serial Device Server

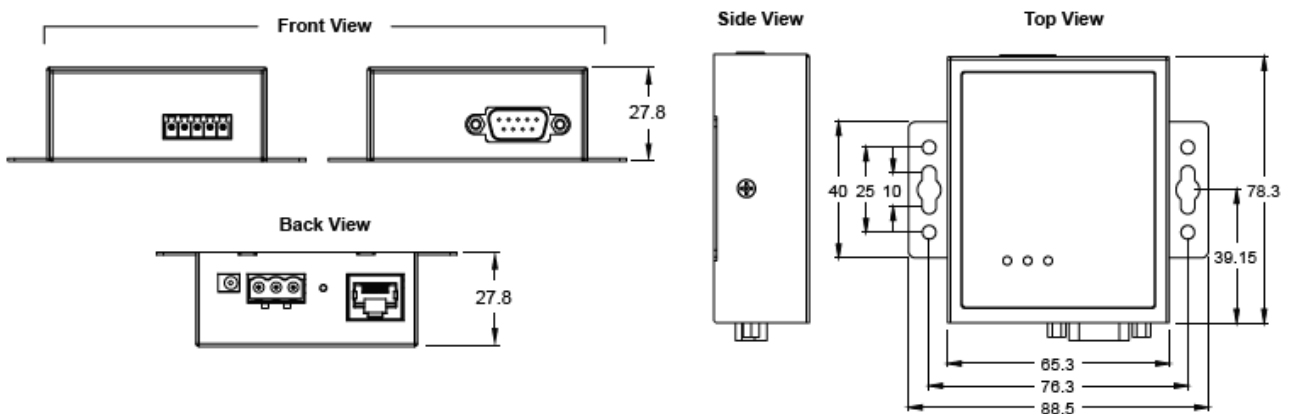

3.3 *First Time Installation*

Before installing the device, please follow strictly all safety procedures described in the Hardware installation guide supplied inside the product. Atop will not be liable for any damages to property or personal injuries resulting from the installation or overall use of the device. Do not attempt to manipulate the product in any way if unsure of the steps described there. In such cases, please contact your dealer immediately.

Specific installation instructions are not provided in this manual since they may differ considerably based on the hardware purchase

3.4 *Factory Default Settings*

3.4.1 *Network Default Settings*

The SE520X Industrial Serial Device Server is equipped with one LAN interface with one default IP address. Its default network parameters are listed in Table 3.3.

Table 3.3 Network Default Setting

Interface	Device IP	Subnet Mask	Gateway IP	DNS
LAN1	10.0.50.100	255.255.0.0	10.0.0.254	0.0.0.0

3.4.2 *Other Default Settings*

The SE520X Industrial Serial Device Server comes with the following default settings.

Table 3.4 Security , Serial, and SNMP Default Settings

Parameter	Default Values
Security	
User Name	admin
Password	default
Serial	
COM1	RS-232, 9600 bps, 8 data bits, No Parity bit,1 stop bit, No Flow Control Packet Delimiter timer: Auto
SNMP	
SysName of SNMP	System
SysLocation of SNMP	Location
SysContact of SNMP	Contact
SNMP	Disabled
Read Community	public
Write Community	private
SNMP Trap Server	0.0.0.0

Note: Press the “Reset” button (inside a small hole) on the back panel between terminal block power input and LAN port for 5 seconds or follow the procedure in Section 4.11.4, to restore the SE520X Series Industrial Serial Device Server to the factory default settings.

4 Configuration and Setup

It is strongly recommended for the user to set the Network Parameters through **Device Management Utility**® first. Other device-specific configurations can later be carried out via Atop's user-friendly Web-Interface.

4.1 Configuration of Network Parameters through Device Management Utility

Please install Atop's configuration utility program called **Device Management Utility**® that comes with the Product CD or can be downloaded from our websites (www.atop.com.tw or www.atoponline.com). For more information on how to install **Device Management Utility**®, please refer to the manual that comes in the Product CD. After you start **Device Management Utility**®, if the SE520X Serial Device Server is already connected to the same subnet as your PC, the device can be accessed via broadcast packets. **Device Management Utility**® will automatically detect your device and list it on **Device Management Utility**®'s window. Alternatively, if you did not see your device on your network, press "Rescan" icon, a list of devices, including your SE520X device currently connected to the network will be shown in the window of **Device Management Utility**® as shown in Figure 4.1.

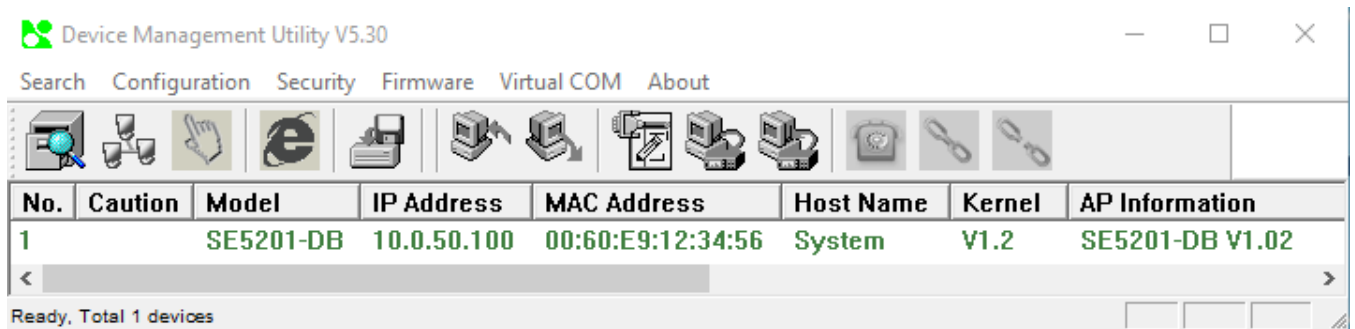

Figure 4.1 List of Device in Device Management Utility

Note: This figure is for illustration purpose only. Actual values/settings may vary between devices.

Sometime the SE520X device might not be in the same subnet as your PC; therefore, you will have to use Atop's utility to locate it in your virtual environment. To configure each device, first click to select the desired device (default IP: 10.0.50.100) in the list of **Device Management Utility**®, and then click "Configuration → Network..." (or Ctrl+N) menu on **Device Management Utility**® as shown in Figure 4.2 or click on the second icon called **Network** on the menu icon bar, and a pop-up window will appear as shown in Figure 4.3.

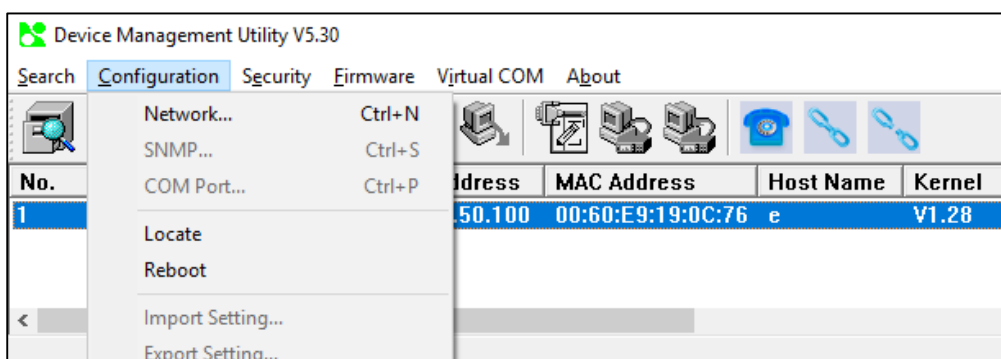

Figure 4.2 Pull-down Menu of Configuration and Network...

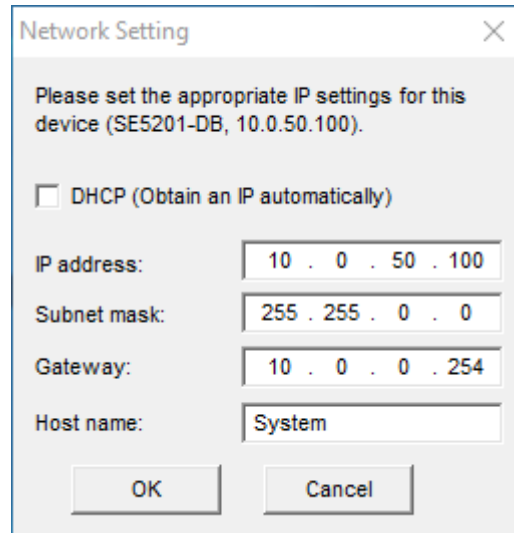

Figure 4.3 Pop-up Window of Network Setting

You may proceed then to change the IP address to avoid any IP address conflict with other hosts on your LAN or to connect the device to your existing LAN as shown in Figure 4.3. The system will prompt you for a credential to authorize the changes. It will ask you for the **Username** and the **Password** as shown in Figure 4.4. The default username is “**admin**”, while the default password is “**default**”. After clicking on the **Authorize** button, a notification window will pop-up as shown in Figure 4.5 and some device may be restarted. After the device is restarted (for some model), it will beep twice to indicate that the unit is running normally. Then, the device can be found on a new IP address. It may be listed automatically by the **Device Management Utility**® or it can be found by clicking on the “**Rescan**” icon. Note that if you did not change the IP address but changed other parameter, you may encounter another notification window as shown in Figure 4.6.

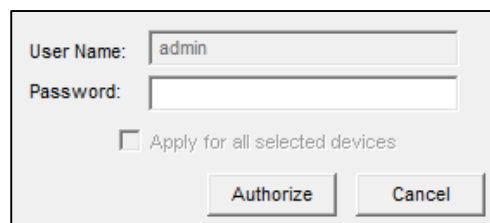

Figure 4.4 Authorization for Change of Network Settings

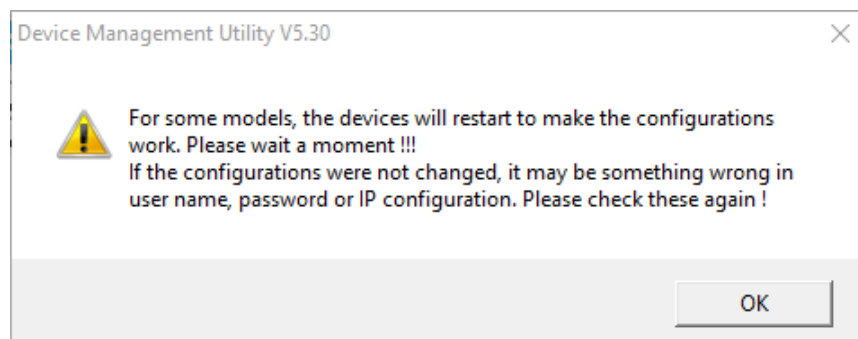

Figure 4.5 Pop-up Notification Window after Authorization

Please consult your system administrator if you do not know your network’s subnet mask and gateway address.

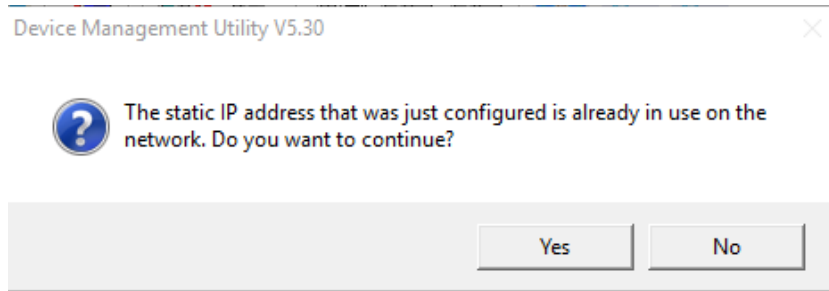
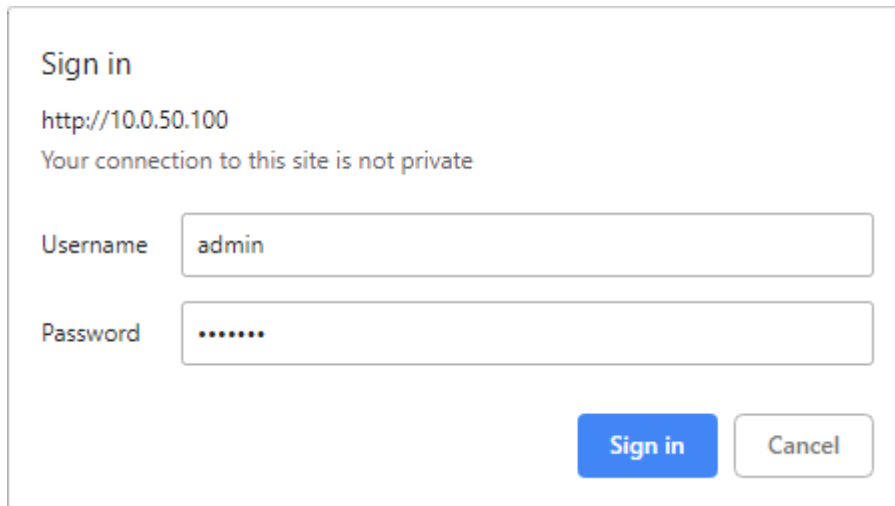

Figure 4.6 Pop-up Notification Window when there is the same IP address in the network

4.2 Configuring through Web/CLI Interface

Every SE520X Industrial Serial Device Server is equipped with a built-in web server in the firmware. Therefore, the device can be accessed by using a web browser for configuring by entering the device's IP address (default IP address is 10.0.50.100) in the URL field of your web browser. An authentication will be required and you will have to enter the username (Default value is "admin") and password (Default value is "default") for accessing the web interface as shown in Figure 4.7. Note that you may encounter a warning pop-up window that urges you to change or reset your password to be different from the default value as shown in Figure 4.8. Figure 4.9 illustrates the overview page of the web interface. Figure 4.10 lists all the menus and submenus for web configuration. Please see Section 3.4 for default values.



The screenshot shows a web browser window titled "Sign in". The address bar displays "http://10.0.50.100". Below the address bar, a message reads "Your connection to this site is not private". There are two input fields: "Username" with the text "admin" and "Password" with seven dots. At the bottom right, there are two buttons: a blue "Sign in" button and a white "Cancel" button.

Figure 4.7 Authentication Required for Accessing Web Interface

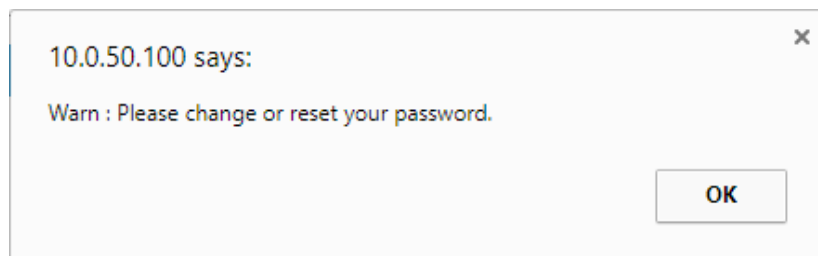

Figure 4.8 Warning Pop-up Window for Changing or Resetting Password from Default Value



- + System Status
- Network Settings
- + Serial
- SNMP/ALERT Settings
- E-mail Settings
- + Log Settings
- + System Setup
- Reboot

System Status > Overview

SE5201-DB SS

Overview

The general information of ATOP - Serial Server

Device Information		
Model Name		SE5201-DB
Device Name		0060E9123456
Kernel Version		1.03
AP Version		1.03
Bootloader Version		1.01
Network Information		
LAN1	MAC Address	00:60:e9:12:34:56
	IP Address	10.0.50.100

Figure 4.9 Overview Web Page of SE520X Industrial Serial Device Server.

- System Status
 - Overview
- Network Settings
- Serial
 - COM1
- SNMP/ALERT Settings
- E-mail Settings
- Log Settings
 - System Log Settings
 - COM Log Settings
 - System Log
 - COM log
- System Setup
 - Date/Time Settings
 - Admin Settings
 - Firmware Upgrade
 - Backup/Restore Configuration
 - Ping
- Reboot

Figure 4.10 Map of Configuring Web Page on SE520X Industrial Serial Device Server

This approach (web interface) for configuring your device is the most user-friendly. It is the most recommended and the most common method used for SE520X Serial Device Server Series. Please go to its corresponding section for a detailed explanation.

Furthermore, you can also use CLI interface through Consol port/Telnet/SSH to configure SE52XX. Enable the Access Control (please refer to System Setup > Admin Settings), then you can use CLI interface.

Admin Settings

Set up the login user name and password.

Account Settings	
User name	<input type="text" value="admin"/>
Old password	<input type="text"/>
New password	<input type="text"/>
Repeat new password	<input type="text"/>

Web mode	
Web Mode	<input checked="" type="radio"/> HTTP <input type="radio"/> HTTPS

Access control	
SSH	<input checked="" type="checkbox"/> Enable
Telnet	<input checked="" type="checkbox"/> Enable

Figure 4.11 Access control

```
-----  
Main Menu  
-----  
[0] Reboot  
[1] Overview  
[2] Network Settings  
[3] COM Port Settings  
[4] SNMP Settings  
[5] ALERT Settings  
[6] E-mail Settings  
[7] System Setup  
[8] Exit and Disconnect  
[9] Restore Factory Default  
.
```

Figure 4.12 CLI interface

Please noted that change IP address need to restart SE520X.

4.3 Configuring Automatic IP Assignment with DHCP

A DHCP server can automatically assign IP addresses, Subnet Mask and Network Gateway to LAN interface. You can simply check the “**DHCP (Obtain an IP Automatically)**” checkbox in the Network Setting dialog as shown in Figure 4.3 using Atop’s **Device Management Utility**® and then restart the device. Once restarted, the IP address will be configured automatically.

4.4 Web Overview

In this section, current information on the device’s status and settings will be displayed. An example of SE5201’s overview page is shown in Figure 4.13.

Device Information		
Model Name	SE5201-DB	
Device Name	0060E9123456	
Kernel Version	1.03	
AP Version	1.03	
Bootloader Version	1.01	
Network Information		
LAN1	MAC Address	00:60:e9:12:34:56
	IP Address	10.0.50.100

Figure 4.13 Overview Web Page

In detail, the following information is given and separated into two parts (Device Information and Network Information):

- **Device Information**
 - **Model Name**, as its name implies, shows the device’s model
 - **Device Name** shows a given name of the device in which the default value is the MAC address of the LAN interface.
 - **Kernel Version** is the value of the version of the kernel firmware of the device.
 - **AP Version** is the value of the version of the application firmware of the device.
 - **Bootloader Version** is the version of the program that loads the operating system of the device.
- **Network Information** shows information about the wired network interface on the device.
 - **LAN:** This will display the current **MAC Address**, and **IP Address** of the Ethernet interface.

4.5 Wizard

In this section, we describe how users can easily configure device for the first-time using Wizard. The wizard will allow user to simply setup password, Date/Time, LAN, and COM port. However, if user wants to set something more advanced, user can manually put in setting values in other menus. Or if user wants to monitor the activities or status of Virtual COM port, user can instead use "Serial/IP Port monitor software program".

There are total six steps/windows in the wizard which are included **Welcome**, **Administration**, **DATE/Time**, **Network**, **COM**, and **Final**. In Step 1/6, **Welcome** window as shown in Figure 4.14 will introduce user how to use the wizard. Click "Next" button to forward to Step 2/6, or "EXIT" to see other menus.

> Wizard SE5201-DB SS

Wizard

Step 1/6

Welcome

Thank you for buying ATOP product! In order to easily configure the device, please follow the instructions on screen. You will be able to interrupt the configuration process at any time saving or discarding the settings you have made

Figure 4.14 Step 1/6 – A Welcome Web Page to the Configuration Wizard

In Step 2/6, **Administration** window as shown in Figure 4.15 will let user set a new password of the login device to increase security. User has to reinput the password in "Repeat New Password" to set the new password. We recommend you to use mixed of upper- and lower-case letters, as well as, numbers and symbols to make it more secure. If you want to go back to Step 1/6, click "Prev" button. Click "Next" button to move on to Date/Time window in Step 3/6. Otherwise, if you want to leave the wizard anytime click "EXIT" button. If "EXIT" button is clicked, a pop-up window will be generated. The user will have a choice to either save or discard the settings which was made until that moment.

> Wizard SE5201-DB SS

Wizard

Step 2/6

Administration

ATOP recommends you to change the device password for increased security. Please input the password in the 'new password' field below and repeat it in the 'Repeat new password' field. Use of upper and lower case letters, numbers and symbols is recommended.

Administration	
New Password	<input type="text"/>
Repeat New Password	<input type="text"/>

Figure 4.15 Step 2/6 – An Administration Web Page to Set Password

In Step 3/6, **Date/Time** window as shown in Figure 4.16 will let user set Date/Time of the device. User can select a proper Time Zone from the dropdown box. If device is connected to the internet or to a local NTP server, the Date/time can be set automatically by selecting option "Synchronize the time automatically from an NTP server". It is selected by default. If you do not want to automatically sync from the NTP server, you can manually set it. For more advanced options such as Daylight-Saving time, you can set it in the "Date/Time settings" page. If this option is chosen, the default value "time.nist.gov" should be shown in the NTP server field. If the SE52XX device is connected to the Internet and should connect to other servers over the Internet to get NTP server, you will need to configure the DNS server in Step 4/6 in order to be able to resolve the host name of the NTP server. Click "PREV" to go back to Step 2/6 to re-enter new password, "NEXT" to move on to **Network** window, or "EXIT" to discard or save the settings until that moment.

> Wizard SE5201-DB SS

Wizard

Step 3/6

Date/Time

This device, if connected to the internet or to a local NTP server can set its system time automatically. Otherwise, you can set the system time manually. You can configure more advanced options such as Daylight Saving time in the 'Date/Time settings' page. Note: if you're using an internet address, please make sure that 'default gateway' and DNS server fields are filled in in the next page of this wizard.

Date/Time	
Time Zone	(GMT-12:00) Eniwetok, Kwajalein
NTP	<input checked="" type="radio"/> Synchronize the time automatically from an NTP server <input type="radio"/> Set up the time manually
NTP Server	time.nist.gov

Figure 4.16 Step 3/6 – A Date/Time Web Page of the Configuration Wizard

In Step 4/6, **Network** window as shown in Figure 4.17 will let user sets network more than one port. In the Network window, it will display "This device has 1 Ethernet ports", You are now setting up LAN1. User has a choice to either set it manually or obtain automatically from a DHCP server. If you selected "Obtain IP address automatically from a DHCP server", the rest of the options for LAN1 settings will be greyed out or disabled. If the option "Set up the network settings manually" is selected, user can input an IP address with subnet mask and gateway, and DNS of the device. User can select Default Internet Gateway your serial device server. DNS (Domain Name Server) is where you can specify the IP Address of your preferred DNS and alternate DNS, which is why there are two DNS IPs to input here. Please consult your network administrator or internet service provider (ISP) to obtain local DNS's IP addresses. Click on "NEXT" to proceed to the next step.

> Wizard
SE5201-DB SS

Wizard

Step 4/6

Network

This device has 1 Ethernet ports, You are now setting up LAN1. The network settings can be obtained automatically from a DHCP server or set up manually. The changes will become effective upon completion of the Configuration Wizard

Lan 1	
Manual/DHCP	<input checked="" type="radio"/> Set up the network settings manually <input type="radio"/> Obtain IP address automatically from a DHCP server
IP	<input type="text" value="10.0.50.100"/>
Subnet Mask	<input type="text" value="255.255.0.0"/>
Gateway	<input type="text" value="10.0.0.254"/>
Default Internet Gateway	<input checked="" type="radio"/>
DNS 1	<input type="text" value="0.0.0.0"/>
DNS 2	<input type="text" value="0.0.0.0"/>

Figure 4.17 Step 4/6 – Network Web Page to Set LAN's IP address

In Step 5/6, **COM** window as shown in Figure 4.18 will let user set COM port of the device. If the device has more than one port (network or COM), there will be one page for each COM within Step 5/6. SE52XX series supports three different **Link Modes** which are **TCP Server**, **TCP Client**, and **UDP**. The **Link Mode** describes the role of SE52XX and the connection between SE52XX device and other remote devices in the network which would like to communicate with serial devices on SE52XX's COM port(s). Please select the one suitable to your end-application. There is no radio is checked for the default. If user wants to set-up more additional advanced settings, you can click on the COMx link on the left-hand side menu to configure.

In this Wizard, **TCP Server and TCP Client** mode can support **RAW** and **Virtual COM**, while **UDP** mode does not have the same supported applications as the previous two TCP modes.

If user selects **TCP Server**, the Serial Server application related to COMx will be waiting for one or more connections to be established on a specific port, and will transfer the data transparently to the end-application (in case that **RAW** radio button is chosen in application submenu) or the data is transferred to a virtualCOM driver installed on your Linux or Microsoft Windows-based computer (in case that **VirtualCOM** is selected in application submenu). In both cases, the default local port is set to 4660.

When the **VirtualCOM** in the application submenu is chosen, the serial device server will be seen as an extension of the COM peripherals on your computer. User can click to download ATOP Device Management Utility and install Serial/IP utility from the provided link.

If user selects **TCP Client**, the Serial Server application which is related to COMx will connect to one or more server's IP addresses/ports. Once a connection is established, the data will be transferred to the server transparently (RAW radio button) or via VirtualCOM. In both cases, the destination IP is set to Server IP address by default, and the destination port is set to 518 by default.

If user selects **UDP**, the Serial Server application related to COMx will transfer the data via UDP to the destination IP and port. Note here that the device can support up to 4 UDP destinations. There are various UDP fields in the "Serial Setting" 's drop-down menus: Mode, Baud rate, Data bit, Parity, and Stop bit. User can select the value that is appropriate to an equipment connected to your device. The Serial Port settings will be effective upon completion

of the Wizard.

> Wizard
SE5201-DB SS

Wizard

Step 5/6

COM

This device has 1 COM ports, You are now setting up COM1. This Serial device Server supports different communication modes. Please select the one suitable to your end-application. If you'd like to set-up additional advanced settings, please click on the COM1 link on the left-hand side menu to configure

COM 1	
Link Mode	<input checked="" type="radio"/> TCP Server: The Serial Server application related to COMx will be waiting for one or more connections to be established on a specific port, and will transfer the data transparently or via VirtualCOM. <input type="radio"/> TCP Client: The Serial Server application related to COMx will connect to one or more servers destination IP addresses/ports. Once connection is established, will transfer the data to the server transparently or via VirtualCOM <input type="radio"/> UDP: The Serial Server application related to COMx will transfer the data via UDP to the destination IP and port. The device supports up to 4 UDP destinations.
Application	<input checked="" type="radio"/> RAW: the data is transferred transparently to the end-application <input type="radio"/> VirtualCOM: the data is transferred to a virtualCOM driver installed on your Linux or Microsoft Windows-based computer. The serial device server will be seen as an extension of the COM peripherals on your computer. Click here to download ATOP Device management Utility and install Serial/IP utility
Local Port	<input type="text" value="4660"/>
Serial Settings	
Mode	<input type="text" value="RS232"/>
Baud Rate	<input type="text" value="1200"/>
Data Bit	<input type="text" value="5 bits"/>
Parity	<input type="text" value="None"/>
Stop Bit	<input type="text" value="1 bits"/>

Figure 4.18 Step 5/6 – COM Web Page to Set COM Port

In Step 6/6, **Final** window as shown in

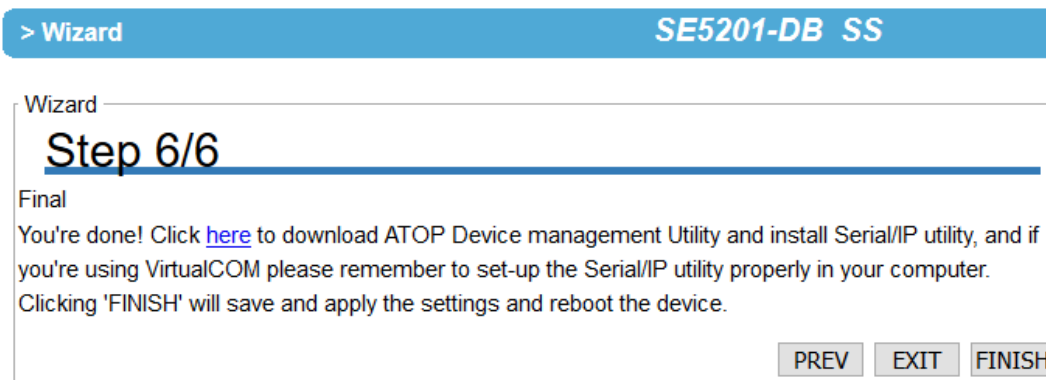

Figure 4.19 will notify user download link for Device Management Utility and Serial/IP utility as well as necessary information for user who uses VirtualCOM.

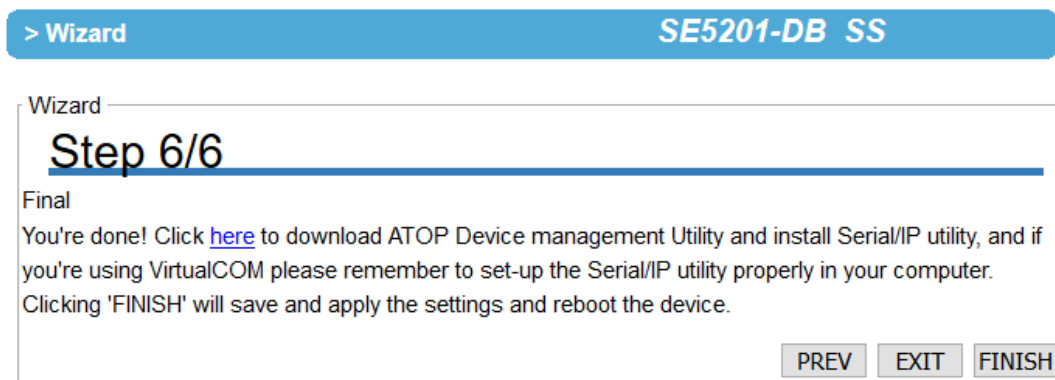

Figure 4.19 Step 6/6 – Final Web Page to Introduce Serial/IP utility

4.6 Network Settings

In this section, both network interfaces and related network settings of the SE520X device can be configured. There are three sets of parameters which are **LAN1 Settings**, **Default Gateway**, and **DNS Server** that can be entered as shown in Figure 4.20. First, **LAN1 Settings** part will allow you to configure the **IP Address**, **Subnet Mask**, and **Default Gateway** for your wired LAN1 network. You can check the box behind **DHCP** option to obtain an IP address automatically. If you checked the box, the rest of the options for **LAN1 Settings** will be greyed out or disabled. Second, **Default Gateway** part is where you can select the default gateway network for your serial device server. However, you can only select **LAN1** in this part because SE520X has only one LAN interface. Third, **DNS Server** part is where you can specify the IP Address of your **Preferred DNS** (Domain Name Server) and **Alternate DNS**. If the device is connected to the Internet and should connect to other servers over the Internet to get some services such as Network Time Protocol (NTP) server, you will need to configure the DNS server in order to be able to resolve the host name of the NTP server. Please consult your network administrator or internet service provider (ISP) to obtain local DNS's IP addresses.

LAN1 Settings	
DHCP	<input type="checkbox"/> Enable
IP Address	<input type="text" value="10.0.50.100"/>
Subnet Mask	<input type="text" value="255.255.0.0"/>
Gateway	<input type="text" value="10.0.0.254"/>

Default Gateway	
Default Gateway Select	<input checked="" type="radio"/> LAN1

DNS Server	
Preferred DNS	<input type="text" value="0.0.0.0"/>
Alternate DNS	<input type="text" value="0.0.0.0"/>

Figure 4.20 Network Settings Web Page

After finishing the network settings configuration, please click the **Save & Apply** button to save all changes that have been made. Finally, the web browser will be redirected to the **Overview** page as shown in Figure 4.13. If you would like to discard any setting, please click the **Cancel** button.

4.7 Serial

Since SE520X is an Serial Device Server, it supports serial communication with COM port(s). Note that SE5201 and SE5201C have only one COM port (**COM1**) while SE5202 has 2 COMs. Figure 4.21 shows the **Serial** menu on the left frame of the web interface of SE5201. The following subsections will describe how to configure the COM port.



- + System Status
- Network Settings
- Serial
 - COM1
- SNMP/ALERT Settings
- E-mail Settings
- + Log Settings
- + System Setup
- Reboot

Figure 4.21 Serial Menu

4.7.1 COM Port Overview

Since details on **Link Mode** connectivity protocols and its settings of SE520X series are given in Chapter 5 Link Modes and Applications, this section will only focus on the **Serial Settings** only. Figure 4.22 shows an example of the **COM 1 Port Settings** where the upper part is dedicated for **Link Mode** settings and the lower part is dedicated for **Serial Settings**.

Serial > COM1
SE5201-DB SS

COM 1 Port Settings

Link Mode
To choose specific working mode for COM 1 port.

TCP Server
 TCP Client
 UDP

TCP Server

Application	RAW ▾
IP Filter	<input type="checkbox"/> Enable
Source IP	0.0.0.0
Local Port	4660
Maximum Connection	1 ▾
Response Behavior	<input type="radio"/> Request & Response Mode <input checked="" type="radio"/> Reply to request only <input type="radio"/> Reply to all <input checked="" type="radio"/> Transparent Mode

To configure COM 1 port parameters.

Serial Settings

Serial Interface	<input checked="" type="radio"/> RS232 <input type="radio"/> RS422 <input type="radio"/> RS485 <input type="radio"/> RS485(4-Wire)
Baud Rate	9600 ▾ bps
Parity	<input checked="" type="radio"/> None <input type="radio"/> Odd <input type="radio"/> Even <input type="radio"/> Mark <input type="radio"/> Space
Data bits	<input type="radio"/> 5 bits <input type="radio"/> 6 bits <input type="radio"/> 7 bits <input checked="" type="radio"/> 8 bits
Stop bits	<input checked="" type="radio"/> 1 bits <input type="radio"/> 2 bits
Flow Control	<input checked="" type="radio"/> None <input type="radio"/> Xon/Xoff <input type="radio"/> RTS/CTS

Figure 4.22 COM 1 Port Settings Web Page

4.7.2 COM Configuration

Figure 4.23 excerpts the **Serial Settings** part of **COM1** port settings of SE520X. Note that these settings need to match the parameters on the serial port of the serial device. Each option is described as follows.

To configure COM 1 port parameters.

Serial Settings	
Serial Interface	<input checked="" type="radio"/> RS232 <input type="radio"/> RS422 <input type="radio"/> RS485 <input type="radio"/> RS485(4-Wire)
Baud Rate	9600 ▼ bps
Parity	<input checked="" type="radio"/> None <input type="radio"/> Odd <input type="radio"/> Even <input type="radio"/> Mark <input type="radio"/> Space
Data bits	<input type="radio"/> 5 bits <input type="radio"/> 6 bits <input type="radio"/> 7 bits <input checked="" type="radio"/> 8 bits
Stop bits	<input checked="" type="radio"/> 1 bits <input type="radio"/> 2 bits
Flow Control	<input checked="" type="radio"/> None <input type="radio"/> Xon/Xoff <input type="radio"/> RTS/CTS

Figure 4.23 Serial Settings Part of COM 1 Port

- **Serial Interface:** This option allows selection between **RS-232**, **RS-422**, **RS-485**, and **RS-485 (4-Wire)** standards. **Note:**
 - RS-485 refers to 2-Wire RS-485 and RS-422 is compatible with 4-Wire RS-485.
- **Baud Rate:** The user can select one of the baud rates (from 1200 to 230,400 bps, RS-485 4-wire allows up to 921,600 bps) from the drop-down list.
- **Parity:** The available Parity options are **None**, **Odd**, **Even**, **Mark**, or **Space**.
- **Data Bits:** The setting for Data Bits can be **5 bits**, **6 bits**, **7 bits**, or **8 bits**.
- **Stop Bits:** The number of Stop Bits can be either **1 bit** or **2 bits**.
- **Flow Control:** The user can choose among **None** (No Flow Control), **RTS/CTS** (Hardware Flow Control), or **Xon/Xoff** (Software Flow Control). If Xon/Xoff is selected, the Xon and Xoff characters are changeable. Defaults are 0x11 for Xon and 0x13 for Xoff. Note that these are hexadecimal number of ASCII characters (i.e., 0x11 = '1' and 0x13 = '3').

After finish configuring the COM Port **Serial Settings**, please click on **Save & Apply** button to keep the change that you have made. Note that after click **Save & Apply**, the web browser will be refreshed and remain on the **Serial Settings** page. If you want to cancel the change and reset all changes back to their original values, just click the **Cancel** button. The **Advanced Settings** button will be described in the next subsection.

4.7.3 COM Configuration: Advanced Settings

For advanced details of COM port setting, you can click on **Advanced Settings** button at the end of **Serial Settings** page which will open another web browser window as shown in COM 1 Port Advance Settings

Advanced Settings		
TCP	TCP Timeout	<input type="checkbox"/> Enable <input type="text" value="0"/> (0~60000) seconds
	TCP Keep-Alive	<input type="checkbox"/> Enable <input type="text" value="0"/> seconds
Delimiters	Serial to Network Packet Delimiter	<input type="checkbox"/> Interval Timeout <input type="text" value="0"/> (1~30000) ms
		<input type="radio"/> Auto(Calculate by baudrate) <input type="radio"/> Manual Setting
		<input type="checkbox"/> Max. Bytes <input type="text" value="0"/> (within one packet: 1 ~ 1452 bytes)
	<input type="checkbox"/> Character <input type="text" value="0x"/> ("0x"+ASCII Code, Ex. 0x0d or 0x0d0a)	
Network to Serial Packet Delimiter	<input type="checkbox"/> Interval Timeout <input type="text" value="0"/> (1~30000) ms	
	<input type="checkbox"/> Max. Bytes <input type="text" value="0"/> (within one packet: 1 ~ 1452 bytes)	
	<input type="checkbox"/> Character <input type="text" value="0x"/> ("0x"+ASCII Code, Ex. 0x0d or 0x0d0a)	
	Response Interval Timeout	<input checked="" type="checkbox"/> Enable <input type="text" value="1000"/> (0 ~ 60000) ms
Serial	Serial FIFO	<input type="checkbox"/> Enable (Disabling this option at baud rates higher than 115200bps would result in data loss).
	Serial Buffer	<input type="checkbox"/> Empty serial buffer when a new TCP connection is established.

Figure 4.24 below. Description of each option is explained as follows.

COM 1 Port Advance Settings

Advanced Settings		
TCP	TCP Timeout	<input type="checkbox"/> Enable <input type="text" value="0"/> (0~60000) seconds
	TCP Keep-Alive	<input type="checkbox"/> Enable <input type="text" value="0"/> seconds
Delimiters	Serial to Network Packet Delimiter	<input type="checkbox"/> Interval Timeout <input type="text" value="0"/> (1~30000) ms
		<input type="radio"/> Auto(Calculate by baudrate) <input type="radio"/> Manual Setting
		<input type="checkbox"/> Max. Bytes <input type="text" value="0"/> (within one packet: 1 ~ 1452 bytes)
	<input type="checkbox"/> Character <input type="text" value="0x"/> ("0x"+ASCII Code, Ex. 0x0d or 0x0d0a)	
Network to Serial Packet Delimiter	<input type="checkbox"/> Interval Timeout <input type="text" value="0"/> (1~30000) ms	
	<input type="checkbox"/> Max. Bytes <input type="text" value="0"/> (within one packet: 1 ~ 1452 bytes)	
	<input type="checkbox"/> Character <input type="text" value="0x"/> ("0x"+ASCII Code, Ex. 0x0d or 0x0d0a)	
	Response Interval Timeout	<input checked="" type="checkbox"/> Enable <input type="text" value="1000"/> (0 ~ 60000) ms
Serial	Serial FIFO	<input type="checkbox"/> Enable (Disabling this option at baud rates higher than 115200bps would result in data loss).
	Serial Buffer	<input type="checkbox"/> Empty serial buffer when a new TCP connection is established.

Figure 4.24 COM 1 Advanced Settings Web Page

TCP

- **TCP timeout:** By clicking the **Enable** box of **TCP Timeout** and input value in seconds between 0 and 60000, SE520X will check if there's any data from serial port. If time expired, SE520X will disconnect to its peer.
- **TCP Keep-alive:** By clicking the **Enable** box of **TCP Keep-alive** and input value in seconds, SE520X will check if its peer is still alive. Note that it will retry 3 times and timeout is 5 seconds in default.

Delimiters

- **Serial to Network Packet Delimiter:** Packet delimiter is a way of packing data in the serial communication. It is designed to keep packets intact. SE520X provides three types of delimiter: **Time Delimiter**, **Maximum Bytes** and **Character Delimiter**. Note that the following delimiters (Interval, Max Byte and Character) when they are selected are programmed in the OR logic. Meaning that if any of the three conditions were met, the device would transmit the serial data in its buffer over the network.
 - ◆ **Interval timeout:** SE520X will transmit the serial data in its buffer when the specified time interval has reached and no more serial data comes in. The default value is calculated automatically based on the baud rate which is the **Auto (calculate by baudrate)** option. If the automatic value results in chopped data, the timeout could be increased manually by switching to **"Manual setting"** (checking the radio button in

COM 1 Port Advance Settings

Advanced Settings		
TCP	TCP Timeout	<input type="checkbox"/> Enable <input type="text" value="0"/> (0~60000) seconds
	TCP Keep-Alive	<input type="checkbox"/> Enable <input type="text" value="0"/> seconds
Delimiters	Serial to Network Packet Delimiter	<input type="checkbox"/> Interval Timeout <input type="text" value="0"/> (1~30000) ms
		<input type="radio"/> Auto(Calculate by baudrate) <input type="radio"/> Manual Setting
		<input type="checkbox"/> Max. Bytes <input type="text" value="0"/> (within one packet: 1 ~ 1452 bytes)
		<input type="checkbox"/> Character <input type="text" value="0x"/> ("0x"+ASCII Code, Ex. 0x0d or 0x0d0a)
Delimiters	Network to Serial Packet Delimiter	<input type="checkbox"/> Interval Timeout <input type="text" value="0"/> (1~30000) ms
		<input type="checkbox"/> Max. Bytes <input type="text" value="0"/> (within one packet: 1 ~ 1452 bytes)
		<input type="checkbox"/> Character <input type="text" value="0x"/> ("0x"+ASCII Code, Ex. 0x0d or 0x0d0a)
	Response Interval Timeout	<input checked="" type="checkbox"/> Enable <input type="text" value="1000"/> (0 ~ 60000) ms
Serial	Serial FIFO	<input type="checkbox"/> Enable (Disabling this option at baud rates higher than 115200bps would result in data loss).
	Serial Buffer	<input type="checkbox"/> Empty serial buffer when a new TCP connection is established.

- ◆ Figure 4.24) and specifying a larger value in the text box above. Note that the maximum interval is 30,000 milliseconds.



Attention

Manual Calculation of Interval Timeout

The optimal "Interval timeout" depends on the application, but it must be at least larger than one-character interval within the specified baud rate. For example, assuming that the serial port is set to 1200 bps, 8 data bits, 1 stop bit, and no parity. In this case, the total number of bits needed to send a character is 10 bits (included 1 start bit), and the time required to transfer one character is $(10 \text{ (bits)}/1200 \text{ (bits/s)}) * 1000 \text{ (ms/s)} = 8.3 \text{ ms}$. Therefore, you should set the "Interval timeout" to be larger than 8.3 ms. Rounding 8.3 ms to the next integer would give you 9 ms. Which can be set as your interval timeout.

- ◆ **Max Bytes:** SE520X will transmit the serial data in its buffer when the specified length in the unit of bytes has reached. The range of maximum bytes is between 1 to 1452 bytes. Enabling this option by checking the box in front of **Max. Bytes**, if you would like SE520X to queue the data until it reaches a specific length. This option is disabled by default.
- ◆ **Character:** SE520X will transmit the serial data in its buffer when it sees the incoming data that includes the specified character (in hexadecimal (HEX) format). This field allows one or two characters. If character delimiter is set to 0x0d, SE520X will push out its serial buffer when it sees 0x0d (carriage return) in the serial data. This option is disabled by default.
- **Network to Serial Packet Delimiter:** This group of options is the same as the delimiters described above, but

they control data flow in the opposite direction. SE520X will store data from the network interface in its queue. Until one of the delimiter conditions described above is met then device will send the data over to the serial interface.

- **Response Interval Timeout:** This option only affects the **Request & Response Mode** and has no effect on the **Transparent Mode**. Please see the discussion about **Request & Respond Mode** versus **Transparent Mode** in Chapter 5, Section 0. When TCP data is received (a request from network) and passed to serial device side, the SE520X will wait for the set time before transferring another TCP data if the serial device side did not receive any data (no response from the serial device). The maximum value for this option is 60,000 milliseconds or 1 minute.

Serial

- **Serial FIFO:** By default, SE520X has its First-In-First-Out (FIFO) function enabled to optimize its serial performance. In some applications (particularly when the flow control mechanism is enabled), it may deem necessary to disable the FIFO function to minimize the amount of data that is transmitted through the serial interface after a flow off event is triggered to reduce the possibility of overloading the buffer inside the serial device. Please note that disabling this option on baud rates higher than 115200bps would noticeably reduce the data integrity.
- **Serial Buffer:** By default, SE520X will empty its serial buffer when a new TCP connection is established. This means that the TCP application will not receive buffered serial data during a TCP link breakage. To keep the serial data when there is no TCP connection and send out the buffered serial data immediately after a TCP connection is established, you can disable this option.

After finish configuring the COM Port's **Advanced Settings**, please click on **Save & Apply** button to keep the change that you have made. Then, the **Advanced Settings** browser window can be closed by clicking on **Close** button and you will be returned to **COM 1 Port Setting** page.

4.8 *SNMP/ALERT Settings*

The Simple Network Management Protocol (SNMP) is used by network management software to monitor devices in a network, to retrieve network status information of the devices, and to configure network parameters of the devices. The **SNMP/ALERT Settings** page showed in Figure 4.25 allows user to configure SE520X device so that it can be viewed by third-party SNMP software, and allows SE520X to send alert events to administrator and SNMP trap server.

> SNMP/ALERT Settings
SE5201-DB SS

SNMP/ALERT Settings

The SNMP is used in network management systems to monitor network-attached devices for conditions that warrant administrative attention.

<i>Basic Data Objects</i>	
System Contact	<input type="text" value="contact"/>
System Name	<input type="text" value="System"/>
System Location	<input type="text" value="location"/>
SNMP	<input checked="" type="checkbox"/> Enable
SNMP Version	<input style="border: none; border-bottom: 1px solid #ccc; background-color: #D9E1F2; text-align: center; font-size: small; color: #0070C0; width: 100px;" type="text" value="v1 / v2c"/> ▼
Read Community	<input type="text" value="public"/>
Write Community	<input type="text" value="private"/>
SNMP Trap Server	
SNMP Trap Server	<input type="text" value="0.0.0.0"/>

Event alert settings

Alert Type	Email	SNMP Trap
Cold start	<input type="checkbox"/>	<input type="checkbox"/>
Warm start	<input type="checkbox"/>	<input type="checkbox"/>
Authenticate failed	<input type="checkbox"/>	<input type="checkbox"/>
IP Address changed	<input type="checkbox"/>	<input type="checkbox"/>
Password changed	<input type="checkbox"/>	<input type="checkbox"/>

Figure 4.25 SNMP/Alert Settings Web Page

SE520X provides three basic SNMP fields under the **Basic Data Objects** part which are: “**System Contact**” usually used to specify the device’s contact information in case of emergency (default value is “contact”), “**System Name**” usually used to identify this device (default value is “System”), and “**System Location**” usually used to specify the device location (default value is “location”).

To make the device’s information available for public viewing/editing, you can enable the **SNMP** function by checking the **Enable** box and fill in the two passphrases (or SNMP Community Strings) below it. Note that when the SNMP is checked, three setting option lines will show up as depicted in Figure 4.25. The supported **SNMP Version** can be selected from the drop-down lists as one of the followings: **v1/v2c**, **v1/v2c/v3**, or **Only v3**. Note that when **v1/v2c/v3** option is selected, you will have three more options to enter and choose which are **User Name**, **Password**, and **Encrypt** as shown in Figure 4.26. The **Encrypt** option can be chosen from **None**, **AES**, or **DES**. By filling in the passphrase for the “**Read Community**”, the device allows other network management software to read its information. By filling in the passphrase for the “**Write Community**”, SE520X device allows other network management software to read/modify its information. The default SE520X’s SNMP Community Strings (or passphrases) for **Read Community** and **Write Community** as shown in Figure 4.25 are “public” and “private”, respectively.

SNMP	<input checked="" type="checkbox"/> Enable
SNMP Version	v1 / v2c / v3 ▼
Read Community	public
Write Community	private
User Name	
Password	
Encrypt	None ▼

Figure 4.26 SNMP Version v1/v2c/v3 is enabled.

Additionally, you can setup a **SNMP Trap Server** in the network to receive and collect all alert messages from SE520X. To configure SE520X to dispatch alert messages originated from any unexpected incidents, you can fill in the IP Address of the **SNMP Trap Server** in the field shown in Figure 4.25. Note that any changes in these settings will take effect after the SE520X device is restarted.

Under the **SNMP Trap Server** part, there is a list of **Alert Type** under **Event alert settings** box in Figure 4.25. There can be up to two possible actions for each alert event: **Email** and **SNMP Trap**. You can enable the associated action(s) of each alert event by checking the box under the column of **Email** and/or **SNMP Trap**. When the **Email** box is checked and the corresponding event occurs, it will trigger an action for SE520X to send an e-mail alert to designated addresses configured in the E-Mail Settings (described in the next section). When the **SNMP Trap** box is checked and the corresponding event occurs, it will trigger an action for SE520X to send a trap alert to the designated SNMP Trap server (specified in the above paragraph). There are five events that will trigger the alarm from SE520X as listed in Figure 4.25. However, some event can only be reported by e-mail. These alerts are useful for security control or security monitoring of the SE520X device:

- **Cold Start:** This event occurs when there is a power interruption.
- **Warm Start:** This event occurs when the device resets.
- **Authentication Failure:** This event occurs when an incorrect username and/or password are entered which could indicate an unauthorized access to the SE520X.
- **IP Address Changed:** This event occurs when the SE520X device's IP address is changed.
- **Password Changed:** This event occurs when the administrator password is changed.

After finish configuring the **SNMP/Alert Settings**, please click on **Save & Apply** button to keep the change that you have made and to apply your setting. When the saving and applying are finished, the web browser will remain on the **SNMP/Alert Settings** page. If you want to cancel the change and reset all changes back to their original values, just click the **Cancel** button.

4.9 E-Mail Settings

When the device raises an alert and/or a warning message, it can send an e-mail to an administrator's mailbox. This **E-mail Settings** page allows you to set up the SE520X to be able to send an e-mail. Figure 4.27 shows the **E-mail Settings** page in which there are two configurable parts: **E-mail Address Settings** and **E-mail Server**. First for the **E-mail Address Settings** part, a **Sender's** e-mail address is required to be filled in the **Sender's** text box which will be used in the **From** field of the e-mail. Note that the maximum length of sender email address is 48 characters. Then, for the **Receiver's** text box you can enter multiple recipients which will be used in the **To** field of the e-mail.

Note that to fill in multiple receiver e-mail addresses in the **Receiver**'s text box, please separate each e-mail address with semicolon (;).

> E-mail Settings
SE5201-DB SS

E-mail Settings

E-mail Address Settings

Sender	<input style="width: 90%;" type="text"/>
Receiver	<input style="width: 90%; height: 40px;" type="text"/> <small>Use a semicolon (;) to delimit the receiver's e-mail address.</small>

E-mail Server

SMTP Server	<input style="width: 90%;" type="text"/>
Authentication	<input type="checkbox"/> SMTP server authentication required. <input checked="" type="checkbox"/> Enable TLS/SSL
User name	<input style="width: 90%;" type="text"/>
Password	<input style="width: 90%;" type="password"/>

Figure 4.27 E-mail Setting Web Page

Second for the **E-mail Server** part, you must enter an **IP address** or **Host Name** of a **Mail Server** which is in your local network in the **SMTP Server**'s text box. Note that the maximum length of SMTP server address is 31 characters. If your Mail Server (or Simple Mail Transfer Protocol (SMTP) Server) requires a user authentication, you must check the "**SMTP server authentication required**" box in the **Authentication** option. Additionally, you can check or uncheck on **Enable TLS/SSL** when the the **SMTP server authentication required** is checked. After enabling this option, you can fill in the **Username** and the **Password** below. Please consult your local network administrator for the **IP address** of your **Mail Server** and the required **Username** and **Password**.



Attention

It is also important to setup Default Gateway and DNS Servers in the Network Settings properly so that SE520X can lookup domain names and route the e-mails to the proper default gateway. Please see the Default Gateway and DNS Sever Settings in Section 4.6.

After finish configuring the **E-mail Settings**, please click on **Save & Apply** button to keep the change that you have made and to apply your setting. When the saving and applying are finished, the web browser will remain on the **E-mail Settings** page. If you want to cancel the change and reset all changes back to their original values, just click the **Cancel** button.

4.10 Log Settings

Under the **Log Settings** menu of web interface of SE520X series Industrial Serial Device Server, you can configure various data logging for the device. Figure 4.28 lists the sub-menu under the **Log Settings**. It consists of **System Log Settings**, **COM Log Settings**, **System Log**, and **COM log**. Each of this sub-menu will be described in the following subsections.

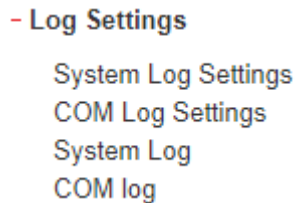

Figure 4.28 Log Settings Menu

4.10.1 System Log Settings

The Syslog function is turned on by default and cannot be turned off for SE520X. It is used to keep log for system events and report to an external Syslog server if necessary. Figure 4.29 shows the **System Log Settings** page under the **Log Settings** menu. Description of each option is provided as follows.

System Log Settings	
Enable Log Event to Flash	<input type="checkbox"/>
Enable Syslog Server	<input checked="" type="checkbox"/>
IP Address	<input type="text" value="0.0.0.0"/>
Syslog Server Service Port	<input type="text" value="514"/> (1~65535, default=514)

Figure 4.29 Log Settings Web Page under Log Settings

- **Enable Log Event to Flash:** When the check box is enabled, SE520X will write log events to the local flash. Otherwise the log events would be cleared when the device restarts because they are stored in the RAM by default.
- **Enable Syslog Server:** When the check box is enabled, it will allow SE520X to send Syslog events to the remote Syslog server with the specified IP address (next option). All the data sent/received from serial interface will be logged and sent to Syslog Server.
- **Syslog Server IP Address:** The user must specify the IP address of a remote Syslog Server in this field.
- **Syslog Server Service Port:** This option allows user to specify the remote Syslog Server Port number between 1 and 65535. Note that the default port number is 514.

After finish configuring the **Log Settings**, please click on **Save & Apply** button to keep the change that you have made and to apply your setting. When the saving and applying are finished, the web browser will remain on the **Log Settings** page. If you want to cancel the change and reset all changes back to their original values, just click the **Cancel** button.

4.10.2 COM Log Settings

Transmitted data through COM port could be logged for recording or debugging purposes. Additionally, the logs could be reported to an external Syslog server as well. Figure 4.30 shows the **COM Log Settings** page under the **Log Settings** menu. Description of each option is explained as follows.

Log Settings > COM Log Settings SE5201-DB SS

COM Log Settings

Log Data Contents Types HEX ASCII

COM Ports COM1

Enable Syslog Server Enable

IP Address

Syslog Server Service Port (1~65535, default=514)

Figure 4.30 COM Log Settings Web Page under System Setup

- **Log Data Contents:** if this option is enabled, the COM logging function will log the content's data that is being transmitted and received in raw bytes. If this option is disabled, COM logging function will only log the length of data to reduce system load.

Note: SE520X can store up to 100 KBytes internally. A request or a response will be in one line, and the data longer than 512 bytes will go into another line. You can retrieve logs by using a **FTP Client**. The FTP login is the same as the WebUI login. Logs are located in `/var/log/logcomxx` (xx is the port number). When the reserved space is full, new logs will replace old logs. We strongly recommend sending COM logs to a remote Syslog server.

- **Data Types:** There are two radio buttons which are hexadecimal (**HEX**) and **ASCII** for user to select the desired logged data's format.
- **COM Ports:** The user can select which port(s) will be logged by checking the corresponding boxes.
- **Enable Syslog Server:** Enabling this option would allow user to send COM logs to a remote Syslog server. It is possible to send COM logs to the same Syslog server used previously for event logging (See Section 4.10.1).
- **IP Address:** When the Syslog Server is enabled in the previous option, please specify the remote Syslog server's IP address in this field.
- **Syslog Server Service Port:** This option allows user to specify the remote Syslog Server Port number between 1 and 65535. Note that the default port number is 514.

After finish configuring the **COM Log Settings**, please click on **Save & Apply** button to keep the change that you have made and to apply your setting. When the saving and applying are finished, the web browser will remain on the **COM Log Settings** page. If you want to cancel the change and reset all changes back to their original values, just click the **Cancel** button.

4.10.3 System Log

This page displays the current event log or system log stored in the SE520X. Figure 4.31 shows an example of logged event. The first two lines are **Severity** option and **Modules** option. You can choose to display the category of the **Severity** which can be **ALL**, **Err** (Error), **Warn** (Warning) or **Info** (Information). Additionally, you can check the **All** box behind the **Modules** option to display log of all modules. Each record of the **System Log** consists of **Time**, **Severity**, and **Message** description.

Log Settings > System Log SE5201-DB SS

System Log

System Log

Severity: ALL ▾

Modules: All

[Refresh](#) [Export Log](#) [Clear Log](#)

Show 10 ▾ entries Search:

#	Time	Sev.	Message
0	Jan 18, 2006 22:44:53	INFO	[Sys] System Start

Showing 1 to 1 of 1 entries

[Previous](#) [Next](#)

Figure 4.31 System Log Web Page under System Setup

At the end of the **System Log** page, there are three hyperlinks which can be used to navigate through all records. You can click on the “**Previous**” link to go to the last page of the log and click on the “**Next**” button to go to the next page. At the top of the **System Log** table, there are three buttons: **Refresh**, **Export Log**, and **Clear Log**. To display the latest event, you can click on “**Refresh**” button. When you click on the Export System Log button, a log file will be saved on to your PC. By clicking on “**Clear System Log**” button, you can clear all events stored in the device and the **System Log** will be empty. A message “No data available in table” will be displayed in the middle of the table. Moreover, you can choose from the drop-down list of 10 or 25 entries for the **Show entries**. Finally, you can search over the **System Log** by entering a keyword in the **Search** box.

4.10.4 COM log

This page displays the current COM log stored in the device. The desired **COM** port number can be selected from the **COM x Log** drop-down list in Figure 4.32, which allows it to display logs from different COM ports. Note that for SE5201 and SE5201C there is only one COM port, while for SE5202 there are two. An example of **COM 1 Log** is shown in Figure 4.32. Each record of the log consists of **Time**, **COM #** (or Index), **Direction (T/R)** and **Data**.

Log Settings > COM log SE5201-DB SS

COM Log

COM 1 Log

[Refresh](#) [Export Log](#) [Clear Log](#)

Show 10 entries Search:

#	Time	COM #	T/R	Data
No data available in table				

Showing 0 to 0 of 0 entries

[Previous](#) [Next](#)

Figure 4.32 COM Datalog Web Page under Log Settings

Under the COM 1 Log header, there are three buttons: **Refresh**, **Export Log**, and **Clear Log**. First, the **Refresh** button can be used to update the COM Log table below with the latest information. Second, the **Export Log** button will enable the user to save the log data onto their PC. The default file name of the exported data log will be **"DataLog.txt"**. Finally, the **Clear Log** button will clear all events stored in the device and the COM Datalog will be empty with a message "No data available in table". At the end of the **COM Log** page, there are two hyperlinks which can be used to navigate through all records. You can click on the **"Previous"** link to go to the previous page of the log and click on the **"Next"** link to go to the next page.

4.11 *System Setup*

Under the **System Setup** menu of web interface of SE520X series Industrial Serial Device Server, you can perform a number of administration tasks for the device. Figure 4.33 lists the sub-menu under the **System Setup**. It consists of **Date/Time Settings**, **Admin Settings**, **Firmware Upgrade**, **Backup/Restore Setting**, and **Ping**. Each of this sub-menu will be described in the following subsections.

- **System Setup**
 - Date/Time Settings
 - Admin Settings
 - Firmware Upgrade
 - Backup/Restore Configuration
 - Ping

Figure 4.33 System Setup Menu

4.11.1 Date/Time Settings

Date and time can be set manually or using Network Time Protocol (NTP) to automatically synchronize date and time of SE520X with a Time Server. Figure 4.34 shows the **Date/Time Settings** page. The first part of the page is the latest **Current Date/Time** which is in the format of **DD/Month/YYYY HH:MM:SS**. The second part of the page is the **Time Zone Settings**. You can select your local **Time Zone** from the drop-down list. The third part of the page is the **NTP Server Settings**. In this part, you can either enable the local NTP service inside SE520X by checking the option **Local NTP Service** below **NTP Settings** part or automatically synchronize with a time server or NTP server. To enable automatic time synchronization, please check the box behind the **Sync with NTP Server** option. Then proceed to enter the **IP address** or **host name** for the **NTP Server**. Note that if a host name is entered, the DNS server must be configured properly (see detail in Section 4.6). The fourth part is the **Daylight Saving Time Settings** that can be enabled when **Enable Daylight Saving Time** box is checked. When it is enabled, the user can select the detailed setting of the daylight saving period, such as **Start Date** and **End Date** with **Offset**. Finally, the last part of the page is the **Manual Time Settings** where you can set **Date** and **Time** using corresponding drop-down lists in Figure 4.34.

System Setup > Date/Time Settings
SE5201-DB SS

Date/Time Settings

The NTP (Network Time Protocol) is used to synchronize the date/time from the NTP server.

Current Date/Time

18 / Jan / 2006 23:18:34

Time Zone Settings

Time Zone (GMT-12:00) Eniwetok, Kwajalein ▼

NTP Settings

Local NTP Service

Sync with NTP Server

NTP Server

Daylight Saving Time Settings

Enable Daylight Saving Time

Start Date -- ▼ / -- ▼ / -- ▼ / -- ▼ (Month / Week / Date / Hour)

End Date -- ▼ / -- ▼ / -- ▼ / -- ▼ (Month / Week / Date / Hour)

Offset 0 ▼ hour(s)

Manual Time Settings

Date -- ▼ / -- ▼ / -- ▼

Time -- ▼ : -- ▼ : -- ▼

Save & Apply
Cancel

Figure 4.34 Date/Time Settings Web Page under System Setup



Attention

It is also important to setup Default Gateway and DNS Servers in the Network Settings properly (See Section 4.6), so SE520X can lookup DNS names and point to the proper NTP server.

After finish configuring the **Date/Time Settings**, please click on **Save & Apply** button to keep the change that you have made and to apply your setting. When the saving and applying are finished, the web browser will remain on the **Date/Time Settings** page. If you want to cancel the change and reset all changes back to their original values, just click the **Cancel** button.

4.11.2 Admin Settings

The SE520X Series allows user and password management through this **Admin Settings** page under **System Setup** menu. By default, the user name is “**admin**” and the password is “**default**”. To set or change their values, you can enter the information in the **User name**, the **Old password**, the **New password** and the **Repeat new password** fields under the **Account Settings** part as shown in Figure 4.35. In the middle of the **Admin Settings** web page, there is the **Web mode** part which allow the user to select the radio button of normal **HTTP** or **HTTPS** for secure communication with the device’s web user interface (Web UI). At the end of the **Admin Settings** web page, there are two more options under **Access Control** part which are **SSH** and **Telnet**. These are available protocols for remote terminal access to the SE520X You can enable or disable each of these methods by checking or unchecking the corresponding **Enable** box.

System Setup > Admin Settings
SE5201-DB SS

Admin Settings

Set up the login user name and password.

Account Settings

User name	<input type="text" value="admin"/>
Old password	<input type="password"/>
New password	<input type="password"/>
Repeat new password	<input type="password"/>

Web mode

Web Mode	<input checked="" type="radio"/> HTTP <input type="radio"/> HTTPS
----------	---

Access control

SSH	<input checked="" type="checkbox"/> Enable
Telnet	<input checked="" type="checkbox"/> Enable

Figure 4.35 Admin Settings Web Page under System Setup

After finish configuring the **Admin Settings**, please click on **Save & Apply** button to keep the change that you have made and to apply your setting. Another pop-up window will be displayed to re-authenticate the user to access the

Web UI of SE520X as shown in Figure 4.7. You must re-enter the username and the password to login to the SE520X. When the saving, applying, and re-authentication are finished, the web browser will remain on the **Admin Settings** page. If you want to cancel the change and reset all changes back to their original values, just click the **Cancel** button.

4.11.3 Firmware Upgrade

Updated firmware for SE520X is provided by ATOP from time to time (for more information please visit Atop News & Events webpage) to fix bugs and optimize performance. It is very important that the device must **NOT be turned off or powered off during the firmware upgrading, (please be patient as this whole process might take up to 5 minutes)**. Before upgrading the firmware, please make sure that the device has a reliable power source that will not be powered off or restarted during the firmware upgrading process.

To upgrade a new firmware to SE520X, please download the latest firmware for your SE520X model from the download tab on the related product page or from the Download page under the Support link on Atop's main webpage. Then, copy the new firmware file to your local computer. Note that the firmware file is a binary file with ".dld" extension. Next, open the Web UI and select **Firmware Upgrade** page under the **System Setup** menu. Then, click "**Browse...**" button as shown in Figure 4.36 below to find and choose the new firmware file. Then, click "**Upload**" button to start the firmware upgrade process. The program will show the upload status. Please wait until the uploading process is finished (the amount of time varies depending on the equipment used). Finally, the device will then proceed to restart itself. In some cases, you might require to re-configure your device. To restore your backup configuration from a file, please see the procedure in the next subsection.

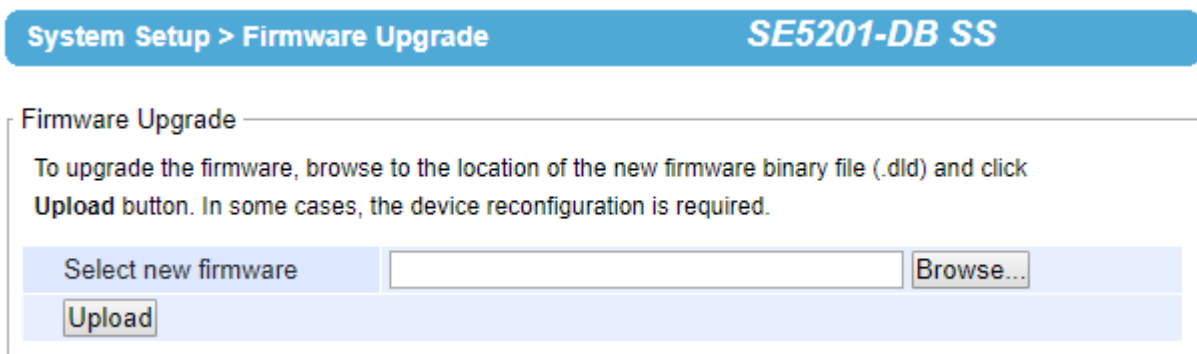

Figure 4.36 Firmware Upgrade Web Page under System Setup

Note: if the firmware upgrade process fails and the device becomes unreachable, please follow the TFTP recovery procedure in Chapter 8 on Emergency System Recovery at the end of this manual.

4.11.4 Backup/Restore Configuration

Once all the configurations are set and the device is working properly, the user should back up the current configuration. The backup configuration file can be used when the new firmware is uploaded and the device is reset to a factory default setting. This is done to prevent accidental loading of incompatible old settings. The backup configuration file could also be used to efficiently deploy multiple Series devices of similar settings by uploading these settings to all devices.

To back up configuration, click "**Backup**" button under the **Backup Configuration** part as shown in Figure 4.37, and a the backup file (ModelName-MACAddress.dat) will be automatically saved on your computer. It is important **NOT to manually modify the saved configuration file by any editor. Any modification to the file may corrupt the file and it may not be used for later restoration.** Please contact Atop authorized distributors for more information on this subject.

To restore the backup configuration, click “**Browse**” button under the **Restore Configuration** part as shown in Figure 4.37 to locate the backup configuration file on user’s computer. Then, click on “**Upload**” button to upload the backup configuration file to the device. Once the backup configuration file is successfully uploaded, the device will restart. Note that the time needed for this process may vary on the equipment used.

If you need to restore the device to its factory default configuration, you can click on the **Restore** button under the **Restore Factory Default** section as shown in Figure 4.37.

The screenshot shows a web interface for configuration management. At the top, there is a blue header bar with the text "System Setup > Backup/Restore Configuration" on the left and "SE5201-DB SS" on the right. Below the header, the main content area is titled "Backup/Restore Configuration". It is divided into three distinct sections, each with a light blue header and a white body:

- Backup Configuration:** The header is "Backup Configuration". The body contains the instruction "Click **Backup** to save the current configuration to your computer." followed by a "Backup" button.
- Restore Configuration:** The header is "Restore Configuration". The body contains the instruction "Browse a backedup configuration and click **Upload** to restore the device's configuration." Below this, there is a text input field, a "Browse..." button, and an "Upload" button.
- Restore Factory Default:** The header is "Restore Factory Default". The body contains the instruction "Click **Restore** to restore factory default configuration." followed by a "Restore" button.

Figure 4.37 Backup/Restore Settings Web Page under System Setup

4.11.5 Ping

The Web UI of SE520X has an interface to call **Ping** which is a network diagnostic utility for testing reachability. You can use the **Ping** function to determine whether SE520X can reach the gateway or other devices in the network. To use the **Ping**, enter a destination IP address in the text box behind the **Ping To** and click **Start** button as shown in Figure 4.38. This process usually takes around 20 seconds. Figure 4.38 represents a successful ping without packet loss from SE520X to the address 10.0.50.101 and back, while Figure 4.39 indicates that the connecting device at the address 10.0.50.202 is unreachable in which no packets have returned from the transmitted ping packets.

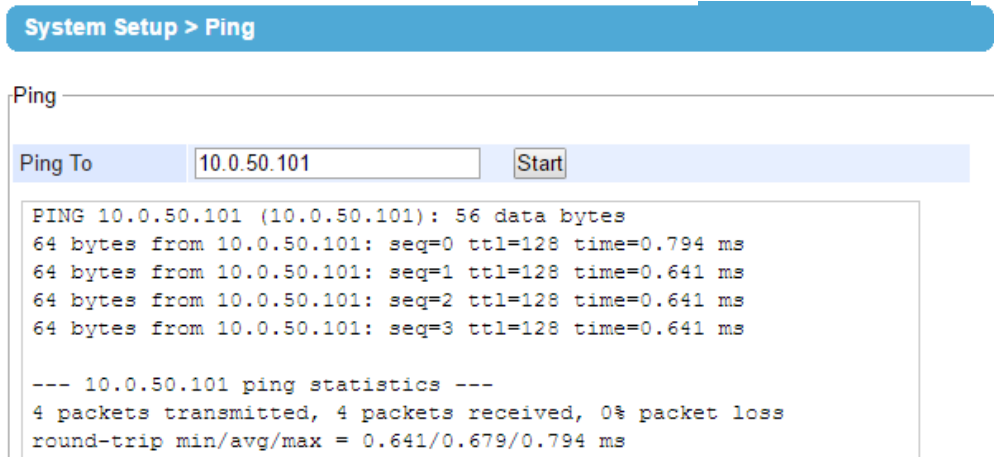

Figure 4.38 Ping Web Page under System Setup

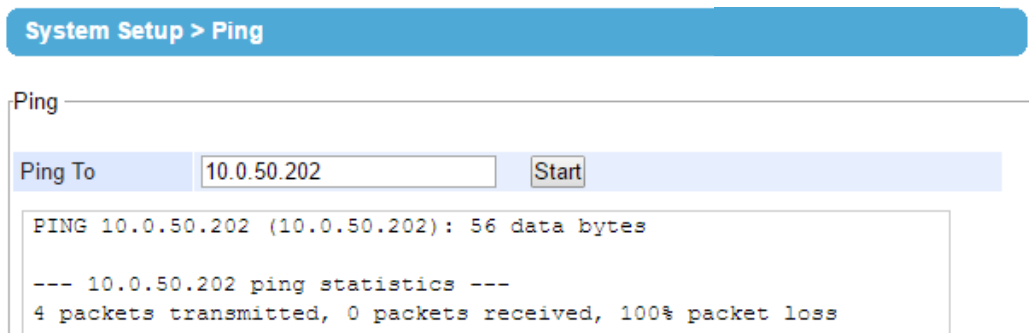

Figure 4.39 Unreachable Ping Example

4.12 Reboot

To manually reboot the device, click on the “**Reboot**” button at the end of the **Reboot** page as shown in Figure 4.40. The device will then restart. When the rebooting process is finished, you will hear the beep sound twice from the device and you might need to refresh your web browser to log into the web interface of the device again.

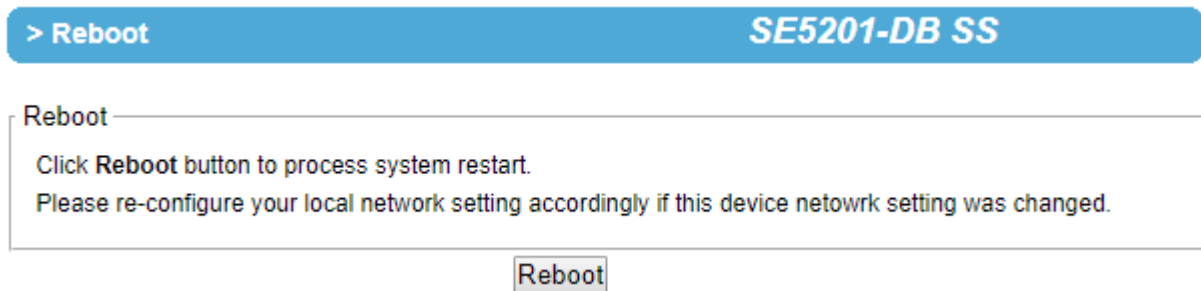

Figure 4.40 Reboot Web Page

5 Link Modes and Applications

5.1 Link Mode Configuration

SE520X series supports three different **Link Modes** which are **TCP Server**, **TCP Client**, and **UDP**. The **Link Mode** describes the role of the device and the connection between the device and other remote devices in the network which would like to communicate with serial device on SE520X's COM port. Under the three Link Modes, **TCP Server** mode can support **RAW**, **Virtual COM**, **Reverse Telnet** and **Pair Connection Master** applications, while **TCP Client** mode can only support **RAW**, **Virtual COM** and **Pair Connection Slave** applications. Note that **UDP** mode does not have the same supported applications as the previous two TCP modes. Discussion on how to setup different Link Modes properly will be presented in the following sections. Figure 5.1 shows the **Link Mode** options for **COM 1** port which can be found on **COM1** page under **Serial** menu of Web UI (See details on Serial Settings in Section Figure 4.21).

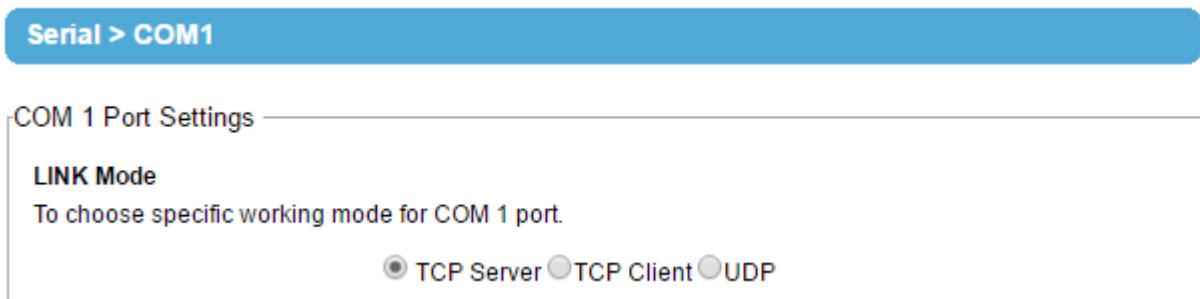

Figure 5.1 Link Mode Options for COM1 Port

5.1.1 Link Mode: Configure as a TCP Server

SE520X series can be configured as a Transport Control Protocol (TCP) server in a TCP/IP network to listen for an incoming TCP client connection to a serial device. Figure 5.2 depicts an example of a PLC (serial) device which is connected to the device on a serial bus where a remote host computer is sending a request via Ethernet network. After the connection is established between the serial device server (SE520X) and the remote host computer (remote TCP client) in the figure, data can be transmitted in both directions. This also applies whenever the Virtual COM (VCOM) application is running on server mode. Please note that this is the SE520X device's default link mode.

TCP Server Mode

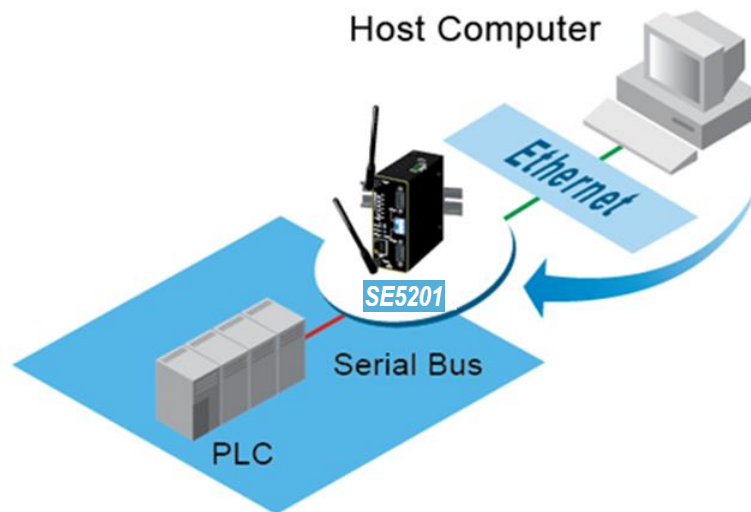

Figure 5.2 SE5201 is set as a TCP Server Link Mode

The default Link Mode of SE520X is the **TCP Server** mode. Figure 5.3 shows an example of configuration setting for **TCP Server** Link Mode under the **COM 1** page. There are additional connection settings that can be configured as shown in Figure 5.3. By selecting the TCP Server Link Mode, a TCP client program on a remote host computer should be prepared to connect to SE520X. Please follow the following steps to configure connection settings of the Link Mode for each COM port.

LINK Mode

To choose specific working mode for COM 1 port.

TCP Server TCP Client UDP

<i>TCP Server</i>	
Application	RAW ▾
IP Filter	<input type="checkbox"/> Enable
Source IP	0 . 0 . 0 . 0
Local Port	4660
Maximum Connection	1 ▾
Response Behavior	<input type="radio"/> Request & Response Mode <input type="radio"/> Reply to requester only <input checked="" type="radio"/> Reply to all <input checked="" type="radio"/> Transparent Mode

Figure 5.3 Connection Settings for TCP Server Link Mode

- Click on the “**COM1**” link on the menu frame on the left side of Web UI to go to **COM 1** page as shown in Figure 5.4.

Serial > COM1

COM 1 Port Settings

Link Mode
To choose specific working mode for COM 1 port.

TCP Server
 TCP Client
 UDP

TCP Server

Application	RAW ▾
IP Filter	<input type="checkbox"/> Enable
Source IP	0.0.0.0
Local Port	4660
Maximum Connection	1 ▾
Response Behavior	<input type="radio"/> Request & Response Mode <input checked="" type="radio"/> Reply to request only <input type="radio"/> Reply to all <input checked="" type="radio"/> Transparent Mode

To configure COM 1 port parameters.

Serial Settings

Serial Interface	<input type="radio"/> RS232 <input checked="" type="radio"/> RS422 <input type="radio"/> RS485 <input type="radio"/> RS485(4-Wire)
Baud Rate	19200 ▾ bps
Parity	<input checked="" type="radio"/> None <input type="radio"/> Odd <input type="radio"/> Even <input type="radio"/> Mark <input type="radio"/> Space
Data bits	<input type="radio"/> 5 bits <input type="radio"/> 6 bits <input type="radio"/> 7 bits <input checked="" type="radio"/> 8 bits
Stop bits	<input checked="" type="radio"/> 1 bits <input type="radio"/> 2 bits
Flow Control	<input checked="" type="radio"/> None <input type="radio"/> Xon/Xoff <input type="radio"/> RTS/CTS

Figure 5.4 TCP Server Link Mode Settings under COM 1 Page

- Select **TCP Server** radio button in the Link Mode options. Note that **TCP Server** is the default Link Mode for COM port of SE520X.
- Under the **TCP Server** section, you will find the following options.
 - **Application:** There are 3 different communication applications to choose from here:
 - **RAW:** There is no protocol on this mode which means that the data is passed transparently.
 - **Virtual COM:** The Virtual COM protocol is enabled on the serial device to communicate with a virtualized port from a remote client. It is possible to create a Virtual COM port on Windows/Linux in order to communicate with the serial device as a remote client.
 - **Reverse Telnet:** This application is used to connect the serial device and another serial device (usually a Terminal Server) with a Telnet program. Telnet programs in Windows/Linux usually require special handshaking to get the outputs and formatting to

show properly. The Device will interact with those special commands (CR/LF commands) once Reverse Telnet application is enabled.

- **Pair Connection Master:** This application is used when the user would like to pair two serial devices over the Ethernet network.
- **IP Filter:** This option will enable the **Source IP** option below. When this option is checked, the device will block or filter out all other IP addresses from accessing the COM port except the one specified in the **Source IP**.
- **Source IP:** This option specifies the remote client's **Source IP** which will be transmitting data to our TCP Server (on SE520X). In other words, our TCP Server will only allow data from this IP address to flow (hence its own name implies Source IP). Note that only one source is allowed.
- **Local Port:** This option specifies the port number that the TCP server (on SE520X) should listen to. It is also used by the remote TCP client to connect to the TCP server. The default local port is 4660. You can enter different port number in this option.
- **Maximum Connection:** This option specifies the maximum number of remote devices/clients (with maximum of 4 clients) that can be connected to the serial device on this COM port.
- **Response Behavior:** This option specifies how the device will proceed or behave when it receives requests from remote connected hosts in which we will have the following options:
 - **Request & Response Mode:** Under this mode, the COM port on the device will hold requests from all other remote connected hosts until the serial device replies or the **Response Interval Timeout** takes into effect to discard it; however, unrequested data sent from the serial device would be forwarded to all connected hosts. Additionally, user can specify how a reply message from the serial device will be sent to the remote connected hosts with two possible options:
 - **Reply to requester only:** The COM port will reply to the remote connected host who has requested the data only.
 - **Reply to all:** A reply is sent to all remote connected hosts.
 - **Transparent mode:** The COM port on the device will forward requests from all remote connected hosts to the serial device immediately and reply to all remote connected hosts once it receives data from the serial device.
- For other **Serial Settings** on the same configuration page, please go to Section 4.7.2 and for **Advanced Settings** please go to Section 0.
- After finish configuring the **Link Mode**, please scroll down to the bottom of the page and click on "**Save & Apply**" button to save all the changes that you have made.

Note: LINK1 is associated with COM1.

5.1.2 Link Mode: Configure as a TCP Client

SE520X series can be configured as a TCP client in TCP/IP network to establish a connection to a TCP server on a remote host computer. Figure 5.5 depicts an example of two serial card readers connected to two different SE520X devices where both devices are on the same Ethernet network as the remote host computer. The arrow in Figure 5.5 indicates the connection request from the client side of TCP connection. After the connection is established, data can be transmitted between a serial device (connected to the COM port of each SE520X) and a remote host computer in both directions. This also applies to Virtual COM application running in the client mode.

TCP Client Mode

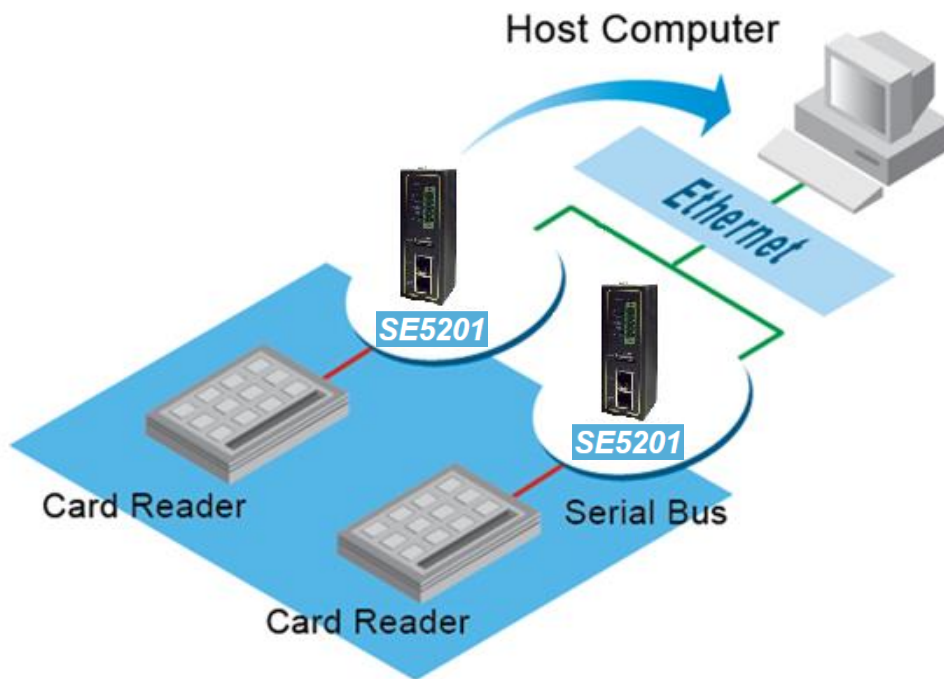

Figure 5.5 Example of SE5201 Configured as TCP Client Link Mode

Figure 5.6 shows an example of configuration setting for **TCP Client** Link Mode under the **COM 1** page. There are additional connection settings that can be configured as shown in Figure 5.7. By selecting the **TCP Client** Link Mode, a TCP server program on a remote host computer should be prepared to accept a connection request from the device. Please follow the following steps to configure connection settings of the Link Mode for each COM port.

COM 1 Port Settings

Link Mode
To choose specific working mode for COM 1 port.

TCP Server
 TCP Client
 UDP

TCP Client	
Application	RAW
Destination IP 1	0.0.0.0
Destination Port 1	0
Backup Destination IP 1	0.0.0.0
Backup Destination Port 1	0
Destination 2	<input type="checkbox"/> Enable
Destination IP 2	0.0.0.0
Destination Port 2	0
Backup Destination IP 2	0.0.0.0
Backup Destination Port 2	0
Response Behavior	<input type="radio"/> Request & Response Mode <input checked="" type="radio"/> Reply to request only <input type="radio"/> Reply to all <input checked="" type="radio"/> Transparent Mode

Figure 5.6 Connection Settings for TCP Client Link Mode

- Click on the **"COM1"** link on the menu frame on the left side of Web UI to go to **COM 1** page as shown in Figure 5.7.

COM 1 Port Settings

Link Mode
To choose specific working mode for COM 1 port.

TCP Server
 TCP Client
 UDP

TCP Client	
Application	Virtual COM
Destination IP 1	0.0.0.0
Destination Port 1	0
Backup Destination IP 1	0.0.0.0
Backup Destination Port 1	0
Destination 2	<input type="checkbox"/> Enable
Destination IP 2	0.0.0.0
Destination Port 2	0
Backup Destination IP 2	0.0.0.0
Backup Destination Port 2	0
Response Behavior	<input type="radio"/> Request & Response Mode <input checked="" type="radio"/> Reply to request only <input type="radio"/> Reply to all <input checked="" type="radio"/> Transparent Mode

Figure 5.7 Setting in TCP Client Link Mode

- Select **TCP Client** radio button in the **Link Mode** options.
- Under the TCP Client section, you will find the following options.
 - **Application**: Only three communication applications are available here: **RAW**, **Virtual COM** and **Pair Connection Slave** in which their definitions are the same as described above in Section 0.
 - **Destination IP 1**: Please specify the preferred **Destination IP** address of the TCP server program on the remote host in this field. This should match the IP settings of the TCP server program.
 - **Destination Port 1**: Please specify the preferred port number of the TCP server program on the remote host in this field. Once again, this should match the IP setting of the TCP server program.
 - **Backup Destination IP 1**: Please specify the preferred **Backup Destination IP** address of the TCP server program on the remote host in this field. Once the Destination IP 1 cannot be reachable, SE520X will send the data to Backup Destination IP 1.
 - **Backup Destination Port 1**: Please specify the preferred port number of the TCP server program on the remote host in this field. Once again, this should match the IP setting of the TCP server program.
 - **Destination 2**: You can enable second remote destination for TCP connection if necessary by checking on the **Enable** box in this option. Two different TCP servers can be set for redundancy.
 - **Destination IP 2**: Please specify the preferred **Destination IP** address of the second TCP server program on the remote host in this field. This should match the IP settings of the second TCP server program.
 - **Destination Port 2**: Please specify the preferred port number of the second TCP server program on the remote host in this field. Once again, this should match the IP setting of the second TCP server program.
 - **Backup Destination IP 2**: Please specify the preferred **Backup Destination IP** address of the TCP server program on the remote host in this field. Once the Destination IP 2 cannot be reachable, SE520X will send the data to Backup Destination IP 2.
 - **Backup Destination Port 2**: Please specify the preferred port number of the TCP server program on the remote host in this field. Once again, this should match the IP setting of the TCP server program.
 - **Response Behavior**: This option specifies how the device will proceed or behave when it receives request from remote connected hosts. The description of each option is the same as described in previous subsection (Section 0 Link Mode: Configure as a TCP Server) .
- For other **Serial Settings** on the same configuration page, please go to Section 4.7.2 and for **Advanced Settings** please go to Section 0 COM Configuration: Advanced Settings.
- After finish configuring the **Link Mode**, please scroll down to the bottom of the page and click on "**Save & Apply**" button to save all the changes that you have made.

5.1.3 *Link Mode: Configure in UDP*

Since User Datagram Protocol (UDP) is a faster transport protocol than TCP but it is a connectionless transport protocol, it does not guarantee the delivery of network datagram. SE520X also supports connectionless UDP protocol compared to the connection-oriented TCP protocol. The SE520X series can be configured to transfer data using unicast or multicast UDP from the serial device to one or multiple host computers. The data can be transmitted between a serial device and a remote host computer in both directions.

There is no server or client concept on this protocol. All networked devices are called peers or nodes. Therefore, you only need to specify the **Local Port** that SE520X should listen to and specify the **Destination IPs** of the remote UDP nodes. Figure 5.8 illustrates an example of UDP Link Mode in which a serial display device is connected on a serial bus and SE520X. Two remote host computers, which are on the same Ethernet network as SE520X, can both send UDP datagram or messages to the serial display device through SE520X.

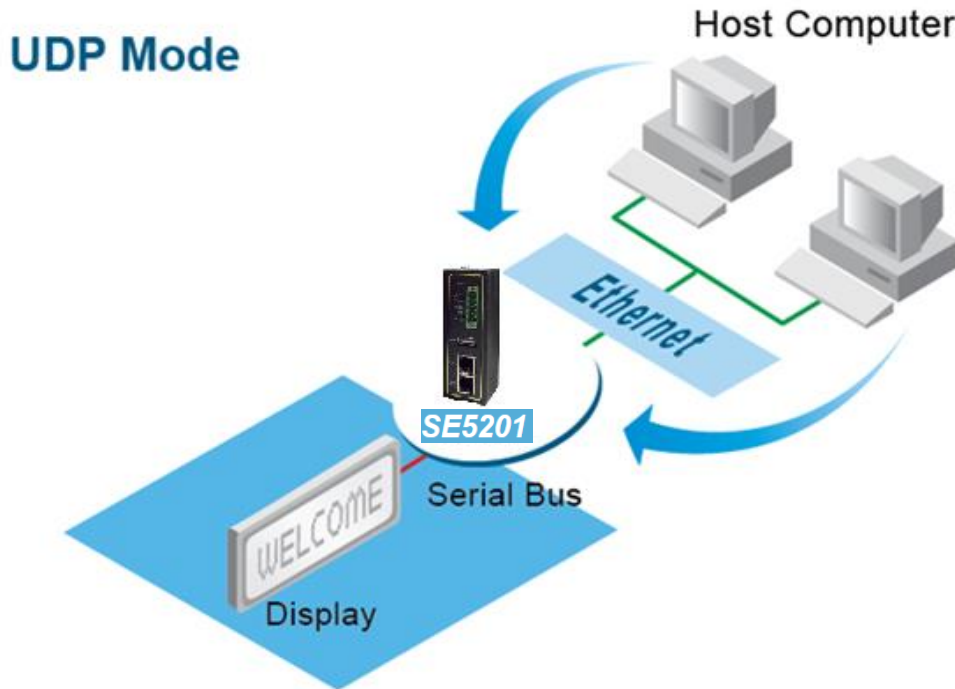

Figure 5.8 Example of SE520X Configured in UDP Link Mode

Figure 5.9 shows an example of configuration setting for **UDP Link Mode** under the **COM 1** page. There are additional connection settings that can be configured as shown in Figure 5.10. Please beware that even though UDP provides better efficiency in terms of response time and resource usage, it does not guarantee data delivery. It is recommended to utilize UDP only with cyclic polling protocols where each request is repeated and independent, such as Modbus Protocol. Please follow the following steps to configure connection settings of the **Link Mode** for each **COM** port.

LINK Mode
 To choose specific working mode for COM 1 port.

TCP Server
 TCP Client
 UDP

UDP						
Local Port: 4660						
<input checked="" type="checkbox"/> Destination IP Address 1	10	.	0	.	50	. 1 ~ 100 Port: 4660
<input type="checkbox"/> Destination IP Address 2	0	.	0	.	0	~ 0 Port: 4660
<input type="checkbox"/> Destination IP Address 3	0	.	0	.	0	~ 0 Port: 4660
<input type="checkbox"/> Destination IP Address 4	0	.	0	.	0	~ 0 Port: 4660

Figure 5.9 Connection Setting in UDP Link Mode

- Click on the **“COM1”** link on the menu frame on the left side of Web UI to go to **COM 1** page as shown in Figure 4.10.

Serial > COM1 ^

COM 1 Port Settings

Link Mode
To choose specific working mode for COM 1 port.

TCP Server
 TCP Client
 UDP

UDP

Local Port:

<input checked="" type="checkbox"/> Destination IP Address 0	<input type="text" value="10"/> . <input type="text" value="0"/> . <input type="text" value="50"/> . <input type="text" value="101"/> ~ <input type="text" value="102"/>	Port: <input type="text" value="511"/>
<input checked="" type="checkbox"/> Destination IP Address 1	<input type="text" value="10"/> . <input type="text" value="0"/> . <input type="text" value="100"/> . <input type="text" value="100"/> ~ <input type="text" value="150"/>	Port: <input type="text" value="252"/>
<input checked="" type="checkbox"/> Destination IP Address 2	<input type="text" value="10"/> . <input type="text" value="0"/> . <input type="text" value="201"/> . <input type="text" value="200"/> ~ <input type="text" value="250"/>	Port: <input type="text" value="65535"/>
<input checked="" type="checkbox"/> Destination IP Address 3	<input type="text" value="10"/> . <input type="text" value="0"/> . <input type="text" value="55"/> . <input type="text" value="100"/> ~ <input type="text" value="100"/>	Port: <input type="text" value="65535"/>

To configure COM 1 port parameters.

Serial Settings

Serial Interface	<input checked="" type="radio"/> RS232 <input type="radio"/> RS422 <input type="radio"/> RS485 <input type="radio"/> RS485(4-Wire)
Baud Rate	<input type="text" value="19200"/> bps
Parity	<input checked="" type="radio"/> None <input type="radio"/> Odd <input type="radio"/> Even <input type="radio"/> Mark <input type="radio"/> Space
Data bits	<input type="radio"/> 5 bits <input type="radio"/> 6 bits <input type="radio"/> 7 bits <input checked="" type="radio"/> 8 bits
Stop bits	<input checked="" type="radio"/> 1 bits <input type="radio"/> 2 bits
Flow Control	<input checked="" type="radio"/> None <input type="radio"/> Xon/Xoff <input type="radio"/> RTS/CTS

Figure 5.10 UPD Link Mode Setting under COM 1 Page

- Select **UDP** radio button in the **Link Mode** options.
- Under the **UDP** section, you will find the following options.
 - **Local Port:** This field specifies the local port number for **UDP Link Mode** on SE520X which it will be listening to and it can be any number between 1 and 65535. Note that typically the port number that is larger than 1024 is recommended to avoid conflicting with the well-known port numbers. You should match this setting with the remote UDP program. Note that this number is usually called destination port in the remote UDP program.
 - **Destination IP Address 1 to 4 and its Port Numbers:** Each line of these options can specify the range of IP addresses and port number that will be communicating with the device. The user can define the **Begin** and **End IP Addresses** here. Four groups of ranges of IP addresses are allowed. Please check the box in front of that particular line to enable it. These are the IP Addresses of the remote UDP programs and the Port that they are listening to. Note that the maximum number of UDP nodes that SE520X can handle would highly depend on the traffic load. We have tested that the device can handle up to 200 UDP nodes (with baud rate of 9600 bps, request interval of 100ms, and data length of 30 bytes).
- For other Serial Settings on the same configuration page, please go to Section 4.7.2 COM Configuration and for Advanced Settings please go to Section 0 COM Configuration: Advanced Settings.
- After finish configuring the **Link Mode**, please scroll down to the bottom of the page and click on "**Save & Apply**" button to save all the changes that you have made.

5.2 Link Mode Applications

This section describes application options for the **TCP Server**, **TCP Client**, and **UDP Link Modes**. The application options will define how the serial data communication will be emulated over the network communication link. The user will have flexibility in choosing the suitable application that matches their need for serial data communication.

5.2.1 TCP Server Application: Enable Virtual COM

SE520X will encapsulate control packets on top of the real data when **Virtual COM** is enabled. This will allow the Virtual COM port on the Windows/Linux operating system to access SE520X's COM ports. The benefit of using Virtual COM is that rewriting an existing COM program to read IP packets is unnecessary. In other words, it is possible to use an ordinary or legacy serial (COM) program. The conversion/virtualization of IP to COM is all done in the system driver transparently. Figure 5.11 shows the device in **TCP Server** mode with **Virtual COM** application enabled. Please follow the following steps to enable **Virtual COM** application in **TCP Server Link Mode**.

LINK Mode

To choose specific working mode for COM 1 port.

TCP Server
 TCP Client
 UDP

TCP Server	
Application	Virtual COM ▼
IP Filter	<input type="checkbox"/> Enable
Source IP	0 . 0 . 0 . 0
Local Port	4660
Maximum Connection	1 ▼
Response Behavior	<input type="radio"/> Request & Response Mode <input type="radio"/> Reply to requester only <input checked="" type="radio"/> Reply to all <input checked="" type="radio"/> Transparent Mode

Figure 5.11 Virtual COM Application in TCP Server Link Mode

- Follow steps in Section 0 to configure the device in **TCP Server Link Mode** properly.
- Click on the drop-down list of the **Application** option under **TCP Server** section and switch to “**Virtual COM**” to enabled Virtual COM application in the device.
- Scroll down to the bottom of the page and click on “**Save & Apply**” button to save the changes.
- Configure Virtual COM in the Operating System on the remote host computer. For Windows, please refer to Chapter 6 for necessary instructions. Please remember SE520X's IP address and the **Local Port** number configured on this page in order to enter the same information in Serial/IP Virtual COM's Control Panel later. Note that a Serial/IP Virtual COM Redirector software is provided as a utility software by Atop Technologies.

5.2.2 TCP Server Application: Enable RFC 2217 through Virtual COM

The underlying protocol of Virtual COM is based on RFC 2217 which is the Telnet COM Control Option. Therefore, it is possible to use RFC 2217 with SE520X in the TCP Server mode. Note that the RFC 2217 allows a remote client,

which can be any network device, to initiate a Telnet session to an access server (i.e. SE5201) to communicate with serial device on the access server's COM port. To do so, please refer to Section 5.2.1 (previous section) to enable Virtual COM so that SE520X becomes aware of the command names and codes defined in RFC 2217. Note that there is no need to configure Virtual COM on the Operating System of the remote host computer because Virtual COM ports would not be used.

5.2.3 TCP Client Application: Enable Virtual COM

It is also possible to run Virtual COM in TCP Client Link Mode. shows a configuration of Virtual COM application in TCP Client Link Mode. It is usually easier to use Virtual COM in the TCP Client Link Mode if SE520X uses dynamic IP (via DHCP) because setting a static IP address in Virtual COM's Control Panel in the Operating System is not possible. Please follow the following steps to enable Virtual COM application in TCP Client Link Mode.

LINK Mode

To choose specific working mode for COM 1 port.

TCP Server TCP Client UDP

TCP Client	
Application	Virtual COM
Destination IP 1	10 . 0 . 50 . 1
Destination Port 1	4660
Destination 2	<input type="checkbox"/> Enable
Destination IP 2	0 . 0 . 0 . 0
Destination Port 2	4660
Response Behavior	<input type="radio"/> Request & Response Mode <input type="radio"/> Reply to requester only <input checked="" type="radio"/> Reply to all <input checked="" type="radio"/> Transparent Mode

Figure 5.12 Virtual COM Application in TCP Client Link Mode

- Follow step in Section 0 to configure SE520X in TCP Client Link Mode properly.
- Click on the drop-down list of the Application option under TCP Client section and switch to "Virtual COM" to enable Virtual COM application in SE520X.
- Scroll down to the bottom of the page and click on "Save & Apply" button to save the changes.
- Configure Virtual COM in the Operating System on the remote host computer. For Windows, please refer to Chapter 6 for necessary instruction. Please remember the **Destination Port** number configured on this page in order to enter this information in Serial/IP Virtual COM's Control Panel later.

5.2.4 TCP Client Application: Enable RFC 2217 through Virtual COM

The underlying protocol of Virtual COM is based on RFC 2217 which is the Telnet COM Control Option. Therefore, it is possible to use RFC 2217 with SE520X in the TCP Client mode. Note that the RFC 2217 allows a client, which is SE520X in this case, to initiate a Telnet session to a remote host computer to communicate with serial device or serial (COM) program on the remote host computer. To do so, please refer to Section 5.2.3 (previous section) to enable Virtual COM so that the device becomes aware of the command names and codes defined in RFC 2217. Note that there is no need to configure Virtual COM on the Operation System of the remote host computer because Virtual COM ports would not be used.

5.2.5 TCP Server Application: Configure as a Pair Connection Master

A Pair Connection application is useful when pairing up two serial devices over the Ethernet or when it is impossible to install Virtual COM in the serial devices. However, the pair connection application does require two SE520Xs to work in pair. One would be the Pair Connection Master and the other would be the Pair Connection Slave. Figure 5.13 shows a configuration of Pair Connection Master application in TCP Server Link Mode. Please follow the following steps to enable Pair Connection application and set the device as Master in TCP Server Link Mode.

Link Mode

To choose specific working mode for COM 1 port.

TCP Server TCP Client UDP

TCP Server	
Application	Pair Connection Master ▼
IP Filter	<input type="checkbox"/> Enable
Source IP	0.0.0.0
Local Port	4660
Maximum Connection	1 ▼
Response Behavior	<input type="radio"/> Request & Response Mode <input checked="" type="radio"/> Reply to request only <input type="radio"/> Reply to all <input checked="" type="radio"/> Transparent Mode

Figure 5.13 Pair Connection Master Application in TCP Server Link Mode

- Follow steps in Section 0 to configure SE520X in TCP Server Link Mode properly.
- Click on the drop-down list of the **Application** option under TCP Server section and switch to “**Pair Connection Master**” to enabled Pair Connection application in the device.
- Scroll down to the bottom of the page and click on “**Save & Apply**” button to save the changes.
- Please remember Pair Connection Master’s IP address (i.e. SE520X’s IP address on your desired network interface (either Ethernet or Wi-Fi)) and Local Port number here in order to enter these information in another SE520X device with the Pair Connection Slave setting later.
- Proceed to the next section to configure a Pair Connection Slave to connect to this Master.

5.2.6 TCP Client Application: Configure as a Pair Connection Slave

A Pair Connection Slave application is configured for SE520X under TCP Client Link Mode as shown in Figure 5.14. It is necessary to pair up with a Pair Connection Master as described in previous section. Please setup a Pair Connection Master on another SE52X1 device first before proceeding. Please follow the following steps to enable Pair Connection application and set this device as Slave in TCP Client Link Mode.

COM 1 Port Settings

Link Mode
To choose specific working mode for COM 1 port.

TCP Server
 TCP Client
 UDP

<i>TCP Client</i>	
Application	Pair Connection Slave ▼
Destination IP 1	10.0.100.50
Destination Port 1	518
Destination 2	<input checked="" type="checkbox"/> Enable
Destination IP 2	10.0.100.60
Destination Port 2	768
Response Behavior	<input type="radio"/> Request & Response Mode <input checked="" type="radio"/> Reply to request only <input type="radio"/> Reply to all <input checked="" type="radio"/> Transparent Mode

Figure 5.14 Pair Connection Slave Application in TCP Client Link Mode

- Follow steps in Section 0 to configure SE520X in TCP Client Link Mode properly.
- Click on the drop-down list of the **Application** option under TCP Client section and switch to “**Pair Connection Slave**” to enabled Pair Connection application.
- Enter the **Destination IP** address and the **Destination Port** number (for Destination 1 and (optionally Destination 2)) that match to the settings of Pair Connection Master (another SE520X device)’s IP and port number that were setup previously.
- Scroll down to the bottom of the page and click on “**Save & Apply**” button to save the changes.

5.2.7 TCP Server Application: Enable Reverse Telnet

Reverse Telnet application is useful if a Telnet program is used to connect to SE520X and the serial interface of the device is connected to a Terminal Server. Telnet programs in Windows/Linux operating systems require special handshaking to get the outputs and the character formatting to show properly. SE520X will interact with those special commands (such as CR/LF commands) if **Reverse Telnet** is enabled. Figure 5.15 shows a configuration of **Reverse Telnet** application in the **TCP Server Link Mode**. Note that the **Reverse Telnet** application is only available when SE520X is configured as **TCP Server Link Mode**. Please follow the following steps to enable **Reverse Telnet** application under the **TCP Server Link Mode**.

LINK Mode

To choose specific working mode for COM 1 port.

TCP Server TCP Client UDP

<i>TCP Server</i>	
Application	Reverse Telnet <input type="button" value="v"/>
IP Filter	<input type="checkbox"/> Enable
Source IP	<input type="text" value="0"/> . <input type="text" value="0"/> . <input type="text" value="0"/> . <input type="text" value="0"/>
Local Port	<input type="text" value="4660"/>
Maximum Connection	<input type="text" value="1"/> <input type="button" value="v"/>
Response Behavior	<input type="radio"/> Request & Response Mode <input type="radio"/> Reply to requester only <input checked="" type="radio"/> Reply to all <input checked="" type="radio"/> Transparent Mode

Figure 5.15 Reverse Telnet Application in TCP Server Link Mode

- Follow steps in Section 0 to configure SE520X in **TCP Server Link Mode** properly.
- Click on the drop-down list of the **Application** option under **TCP Server** section and switch to “**Reverse Telnet**” to enabled reverse telnet application in SE520X.
- Scroll down to the bottom of the page and click on “**Save & Apply**” button to save the changes.

6 VCOM Installation & Troubleshooting

6.1 Enabling VCOM

The device will encapsulate control packets on top of the actual serial data when **Virtual COM (VCOM) Application** is enabled. This will allow the Virtual COM port in the Windows/Linux system to access SE520X's COM ports. Please note that **Virtual COM Application** can only be enabled in **TCP Server Link Mode** as shown in Figure 6.1 or **TCP Client Link Mode** as shown in Figure 6.2.

COM 1 Port Settings

LINK Mode
To choose specific working mode for COM 1 port.

TCP Server TCP Client UDP

TCP Server	
Application	Virtual COM
IP Filter	<input type="checkbox"/> Enable
Source IP	0 . 0 . 0 . 0
Local Port	4660
Maximum Connection	1
Response Behavior	<input type="radio"/> Request & Response Mode <input type="radio"/> Reply to requester only <input checked="" type="radio"/> Reply to all <input checked="" type="radio"/> Transparent Mode

Figure 6.1 Enable a Virtual COM Application When Setting the Link Mode as the TCP Server

COM 1 Port Settings

LINK Mode
To choose specific working mode for COM 1 port.

TCP Server TCP Client UDP

TCP Client	
Application	Virtual COM
Destination IP 1	0 . 0 . 0 . 0
Destination Port 1	4660
Destination 2	<input type="checkbox"/> Enable
Destination IP 2	0 . 0 . 0 . 0
Destination Port 2	4660
Response Behavior	<input type="radio"/> Request & Response Mode <input type="radio"/> Reply to requester only <input checked="" type="radio"/> Reply to all <input checked="" type="radio"/> Transparent Mode

Figure 6.2 Enable a Virtual COM Application When Setting the Link Mode as the TCP Client

Virtual COM on host computer allows remote access of serial devices over TCP/IP networks through Serial/IP Virtual COM ports that work like local native COM ports. Figure 6.3 is an example of Virtual COM application diagram. In the diagram, multiple serial servers (i.e. SE5201 devices) in which each one connects to serial device are connected over an Ethernet hub. Their serial devices can be accessed through the TCP/IP network of the hub. Note that there are traditionally only two Physical COM ports (COM 1 and COM 2) on the personal computer (PC) while there can be several Virtual COM ports such as COM 3, 4, 5, and so on. In SE520X case, the TCP/IP network can be wired network such as Ethernet.

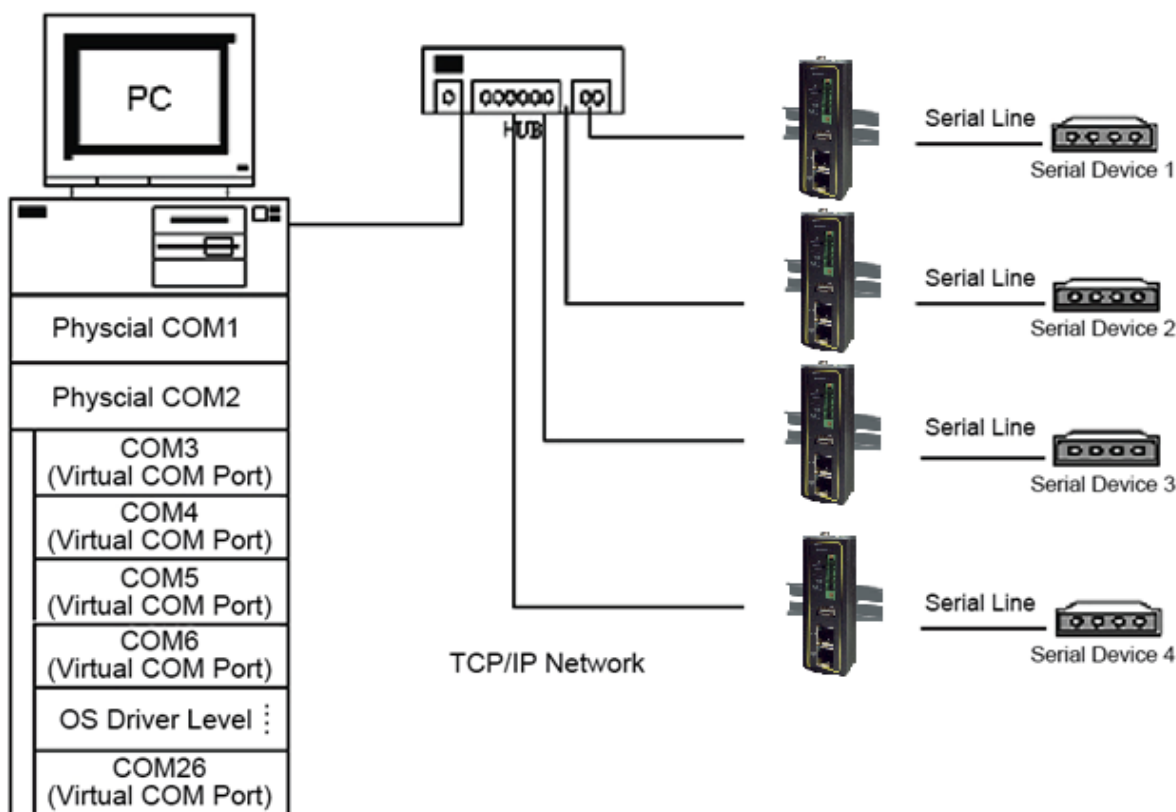

Figure 6.3 An Example Diagram of Virtual COM Application over TCP/IP Network

To enable Virtual COM on host computer, you will require a software utility or VCOM driver software to emulate the COM port. For Windows operating system, a software utility called **Serial/IP** is supported by Atop to be used for this purpose. Please see discussion about the VCOM driver utility in the following subsections.

6.1.1 VCOM driver setup

The supported VCOM driver or Serial/IP utility has the following requirements.

System Requirements

- Windows Operating System Supported Platform (32/64 bits)
 - Win10
 - Win8
 - Win7
 - Vista
 - XP
 - 2008
 - 2003 (also Microsoft 2003 Terminal Server)
 - 2000 (also Microsoft 2000 Terminal Server)
 - NT (also Microsoft NT Terminal Server)
 - 4.0
 - 9x
 - Citrix MetaFrame Access Suite
- Linux operating system also available, but first you might need to download a separate package called Virtual COM driver for Linux (TTYredirector) available for download on Atop website or in the product CD. The zipped package includes a binary file for installation and a manual for Linux systems.

6.1.2 *Limitation*

The Virtual COM driver allows up to 256 Virtual COM ports in a single PC. Selection of COM port number can be allowed in the range from COM1 to COM4096. Note that COM ports that are already occupied by the system or other devices will not be available.

6.1.3 *Installation*

Run the Virtual COM setup file included in the CD or download a copy from our website to install the Virtual COM driver for your operating system. Please turn off your anti-virus software and try again if the installation fails. At the end of the installation, please select at least one Virtual COM port from the Serial/IP Control Panel.

6.1.4 *Uninstallation*

- From Windows Start Menu select Control Panel then select Add/Remove Programs.
- Select Serial/IP Version x.x.x in the list of installed software.
- Click the Remove button to remove the program.

6.2 *Enable VCOM in Serial Device servers and Select VCOM in Windows*

This section will provide the procedure to enable Virtual COM (VCOM) on SE520X and Windows based PC. Please follow the steps described here to configure your Virtual COM application.

6.2.1 *Enable VCOM in Serial Device servers*

Enable **Virtual COM** in our serial device servers (i.e. SE520X) by logging into our Web UI. It is located under **COM 1** or other **COM X** configuration under **Serial** menu as described in Section 5.2.1. Figure 6.4 shows how to enable **Virtual COM** in **TCP Server Link Mode** in SE520X. For a detail of **Link Mode** configuration with **Virtual COM**, please refer to the previous chapter starting from Section 5.1 on **Link Mode** configurations.

LINK Mode

To choose specific working mode for COM 2 port.

TCP Server TCP Client UDP

TCP Server	
Application	Virtual COM
IP Filter	<input type="checkbox"/> Enable
Source IP	0 . 0 . 0 . 0
Local Port	4660
Maximum Connection	1
Response Behavior	<input type="radio"/> Request & Response Mode <input type="radio"/> Reply to requester only <input checked="" type="radio"/> Reply to all <input checked="" type="radio"/> Transparent Mode

Figure 6.4 Enable Virtual COM Application for COM 2 in TCP Server Link Mode

6.2.2 Running Serial/IP Software Utility in Windows

After installation of Virtual COM driver on Windows operating system as described in Section 6.1.3, you can open **Serial/IP Control Panel** by following any one of these methods:

- 1) Click on Windows' Start menu → Select All Programs → Select Serial/IP → Select Control Panel.
- 2) In the Windows' Control Panel, open the Serial/IP applet.
- 3) In the Windows notification area as shown in Figure 6.5, right click on the Serial/IP tray icon and click on Configure... menu to open the Serial/IP's Control Panel.

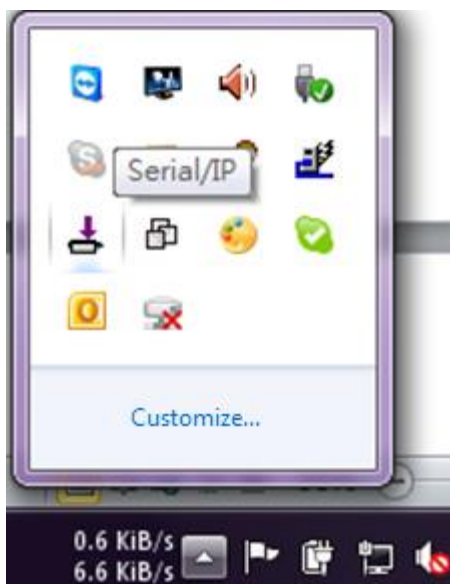

Figure 6.5 Serial/IP Tray Icon on Windows Notification Area

If no Virtual COM port is selected, a **“Select Ports”** dialog window will pop up and ask the user to select at least one COM port as the Virtual COM port before proceeding as shown in the pop-up window of Figure 6.6. You can select a COM port by checking the box in front of the list of virtual COM ports. Note that if a COM port number is not on

the list, it may be used by other application or your operating system. The user may want to select a range of multiple COM ports to be used as Virtual COM ports by entering the range of COM port in the text box below the list. After selecting the virtual COM ports, please click OK button to proceed.

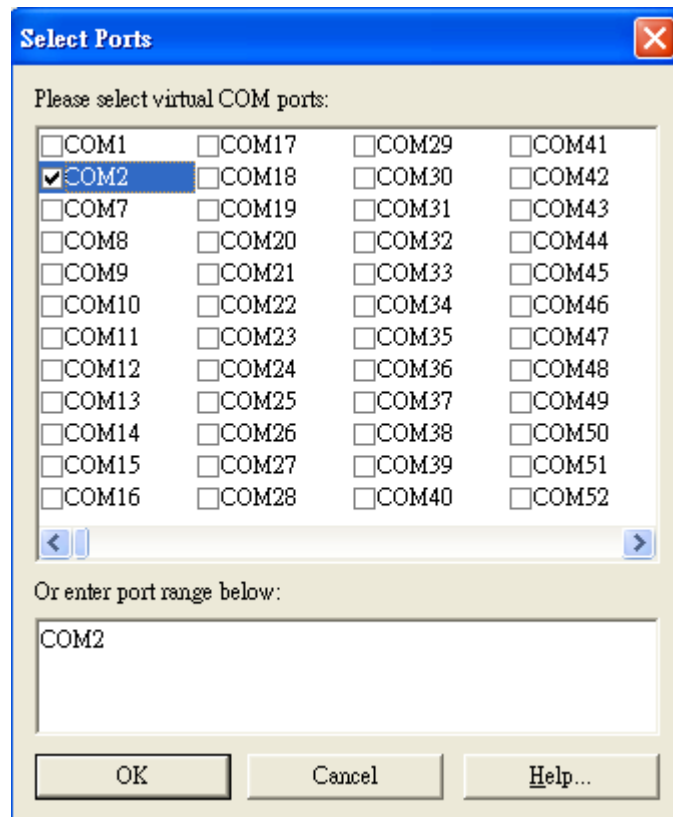

Figure 6.6 A Pop-up Window for Selecting Virtual COM Ports

After at least one Virtual COM port is selected, the **Serial/IP Control Panel** window will show up as illustrated in Figure 6.7. The left side of the **Control Panel** window shows the list of selected Virtual COM ports. You can click on **Select Ports...** button below the list to add or remove Virtual COM ports from the list. The right side of the **Serial/IP Control Panel** window shows the configurations of the selected Virtual COM port marked in blue on the list. Each Virtual COM port can have its own settings. Details on how to configure the Virtual COM port will be described in the next subsection.

Note: The changes to Virtual COM ports apply immediately so there is no need to save the settings manually. However, if the Virtual COM port is already in use, it is necessary to close the Virtual COM port and open it after the TCP connection closes completely in order for the changes to take effect.

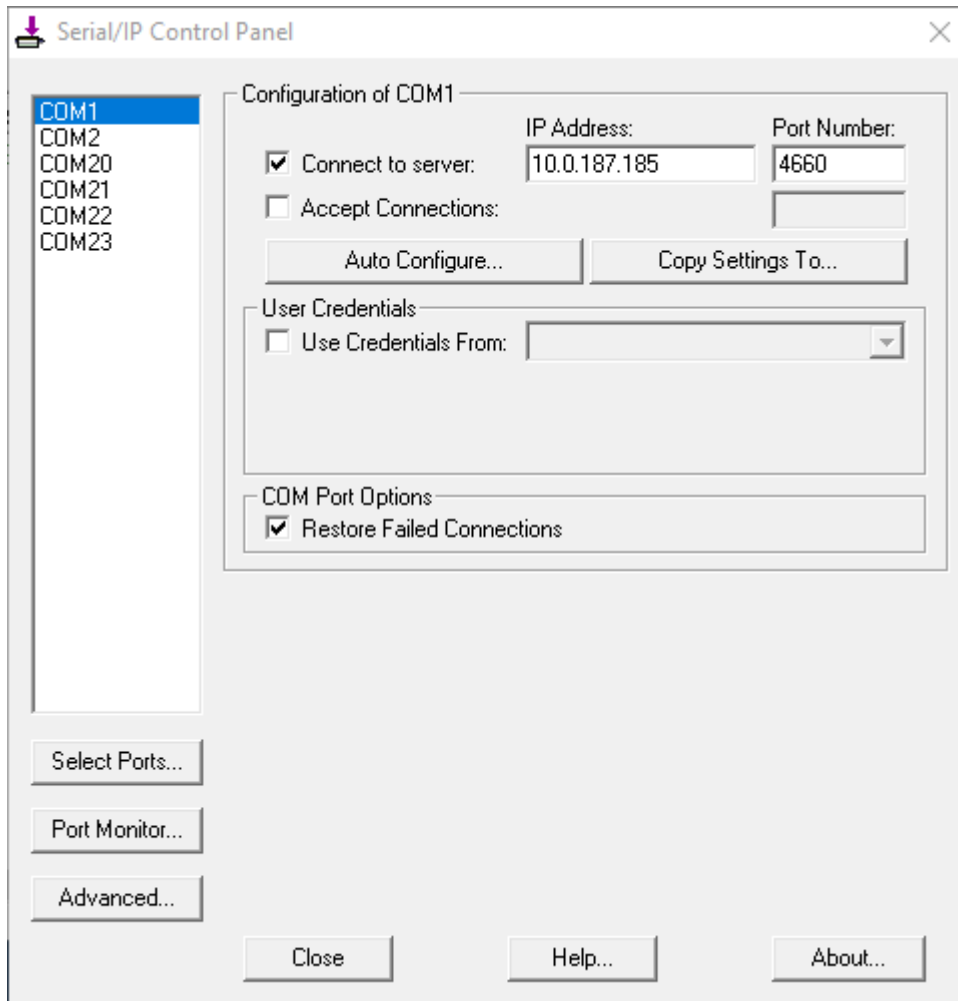

Figure 6.7 Serial/IP Control Panel Window

6.2.3 Configuring VCOM Ports

For each VCOM port selected on the listed on the left side of the **Serial/IP Control Panel**, you can use the following procedures to configure that VCOM port.

1. If the serial device server (i.e. SE5201) is running in **TCP Server Link Mode** (recommended), the **Serial/IP** utility on the host computer should be configured as the TCP client connecting to the serial device server. Enable **Connect to Server** option (by checking the box in front of it as shown in Figure 6.9) and enter the IP Address of the serial device server with the specified **Port Number**. The **Port Number** here is the **Local Listening Port** for the serial device server which is specified in the **Local Port** field of Figure 5.11.
2. If the serial device server (i.e. SE5201) is running in **TCP Client Link Mode**, the **Serial/IP** utility on the host computer should be configured as the TCP server waiting for a serial device server to connect to the host computer. Enable **Accept Connections** option (by checking the box in front of it) and enter the specified **Port Number**. This **Port Number** is the **Destination Port** of the serial device server. Do not enable **Connect to Server** option and **Accept Connections** option simultaneously.
3. Under **User Credentials** box, you can enable **Use Credentials From:** option by checking the box in front of it then select options from the drop-down list. The available sources of credentials are: **Prompt on COM Port Open**, **Prompt at Login**, and **Use Credentials Below** as shown in Figure 6.8. If you select **Use Credentials Below** option as shown in Figure 6.9, please specify the **Username** and the **Password** in their corresponding text boxes.

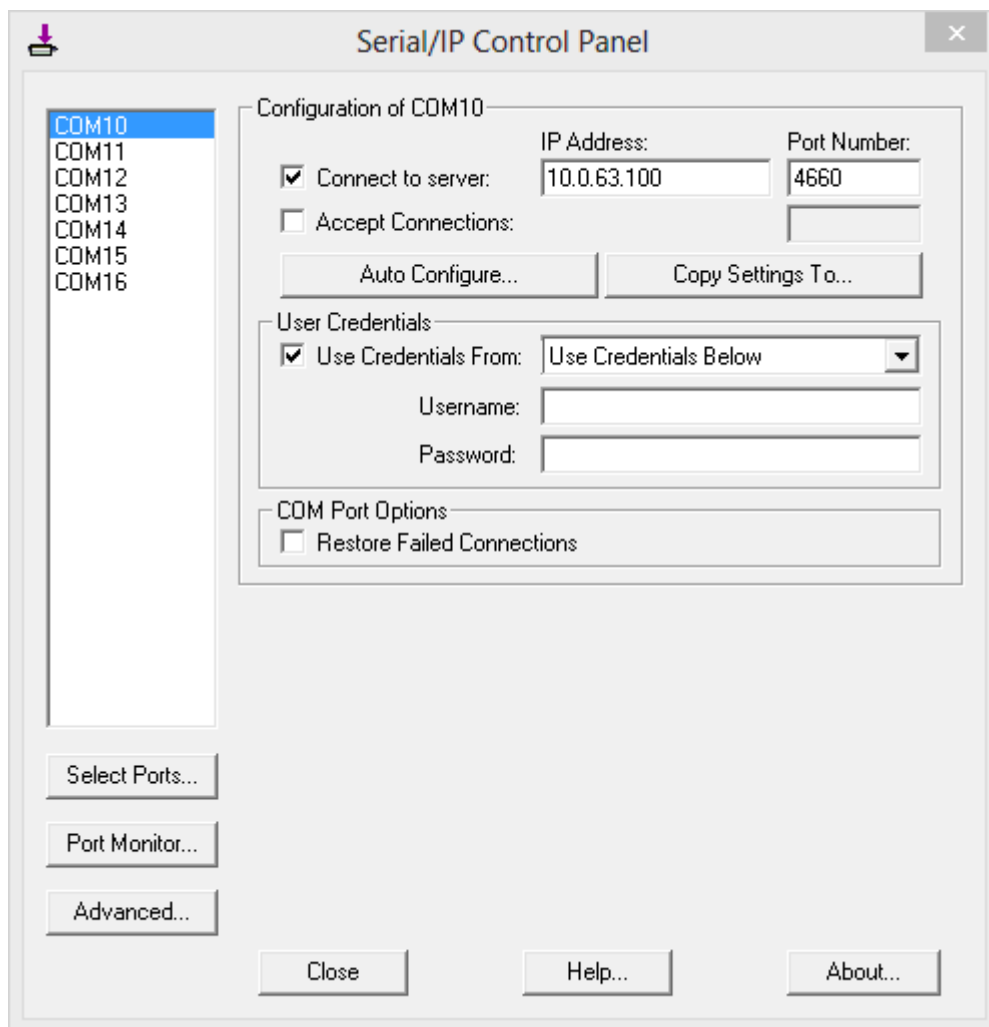

Figure 6.8 Available Options for Use Credential From in Serial/IP Control Panel Version 4.9.10

4. Under **COM Port Options** box, you can enable **Restore Failed Connections** option by checking the box in front of it to force Virtual COM to automatically restore failed connections with the serial device server in case of unstable network connections.
5. To test the Virtual COM connection, you can click the **Auto Conigure...** button and then click the **Start** button in the pop-up window as shown in Figure 6.10. If the test passes, all checks under the **Status** text box should be green. In this **Configuration Wizard** window, you can change the **IP Address** of Server, **Port Number**, **Username** (if **Use Credential** option is enabled), and **Password** (if **Use Credential** option is enabled). To apply the changes in the Configuration Wizard window to the Serial/IP Control Panel, please click on **Use Settings** button at the bottom of the window in Figure 6.10. You can also click on **Copy** button to copy the results to the PC system clipboard.
6. To transfer the settings between Virtual COM ports, click on the **Copy Settings To** button as shown in Figure 6.9.

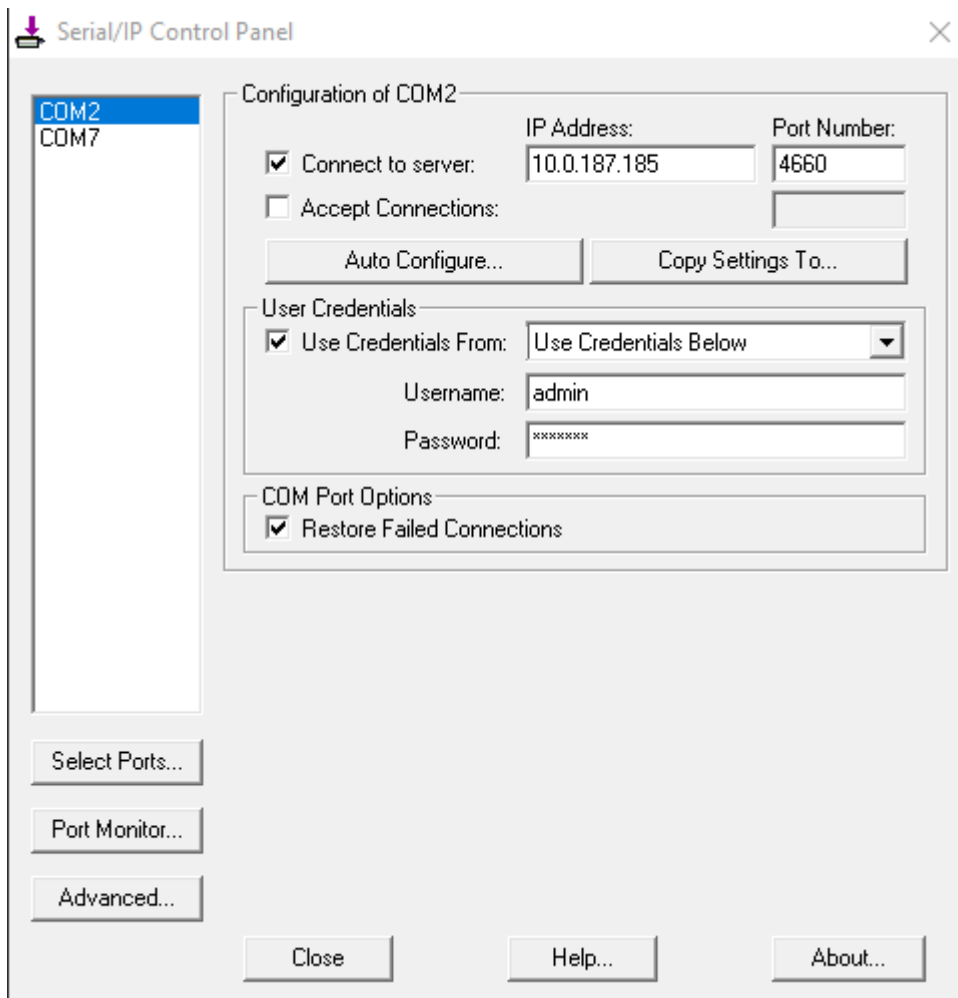

Figure 6.9 Configuring Virtual COM 2 Port as TCP Client

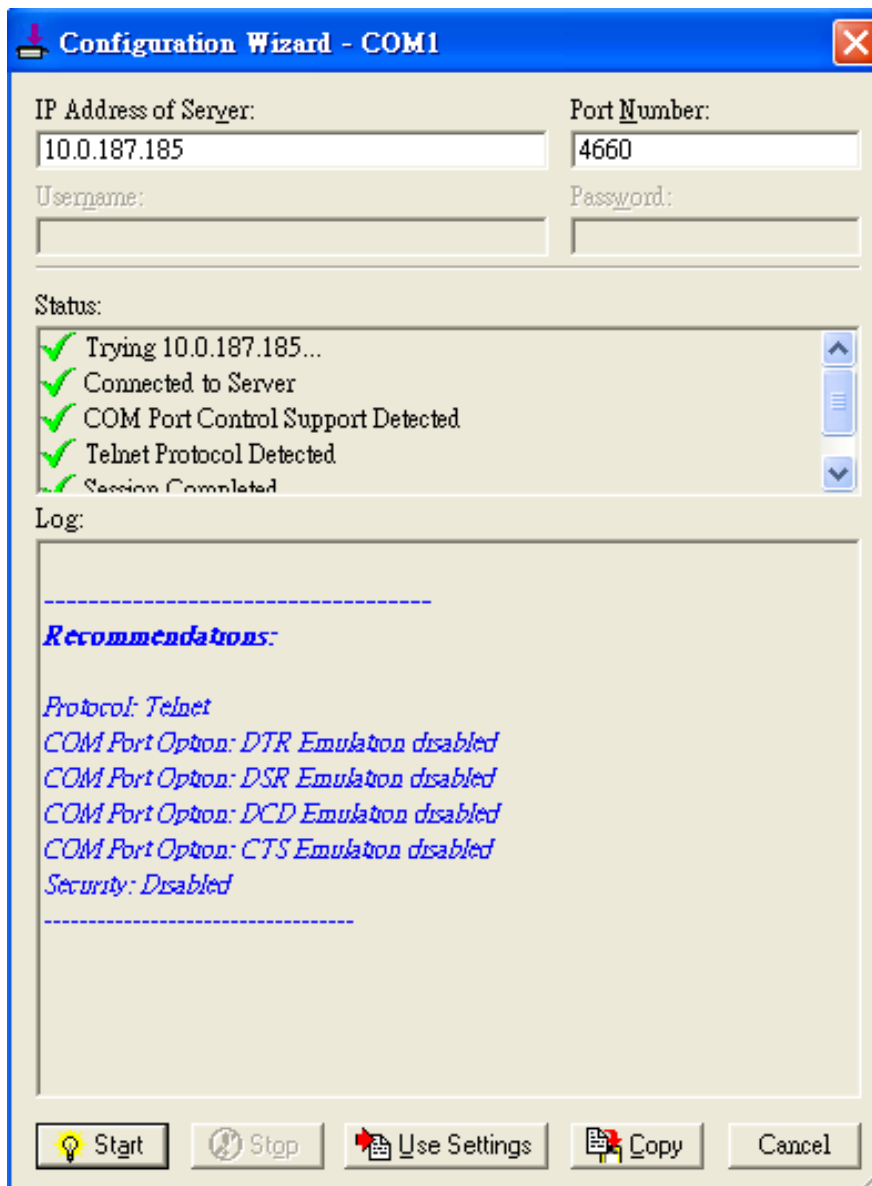

Figure 6.10 Auto Configure (formerly Configuration Wizard) Window for COM 1

6.3 Exceptions

This section lists possible exceptions which may occur when the user tested the VCOM connection through the **Auto Configure...** (formerly **Configuring Wizard...**) button. If there is a problem with the connection, there will be error(s) or warning(s) reported in the **Status and Log** text boxes. The possible correction or trouble shooting hint for each exception is given in each case.

- If the status reports with an exclamation mark with a message “Warning: timeout trying x.x.x.x” as shown in Figure 6.11, please recheck or correct the VCOM IP address and Port number configuration or the PC’s network configuration.

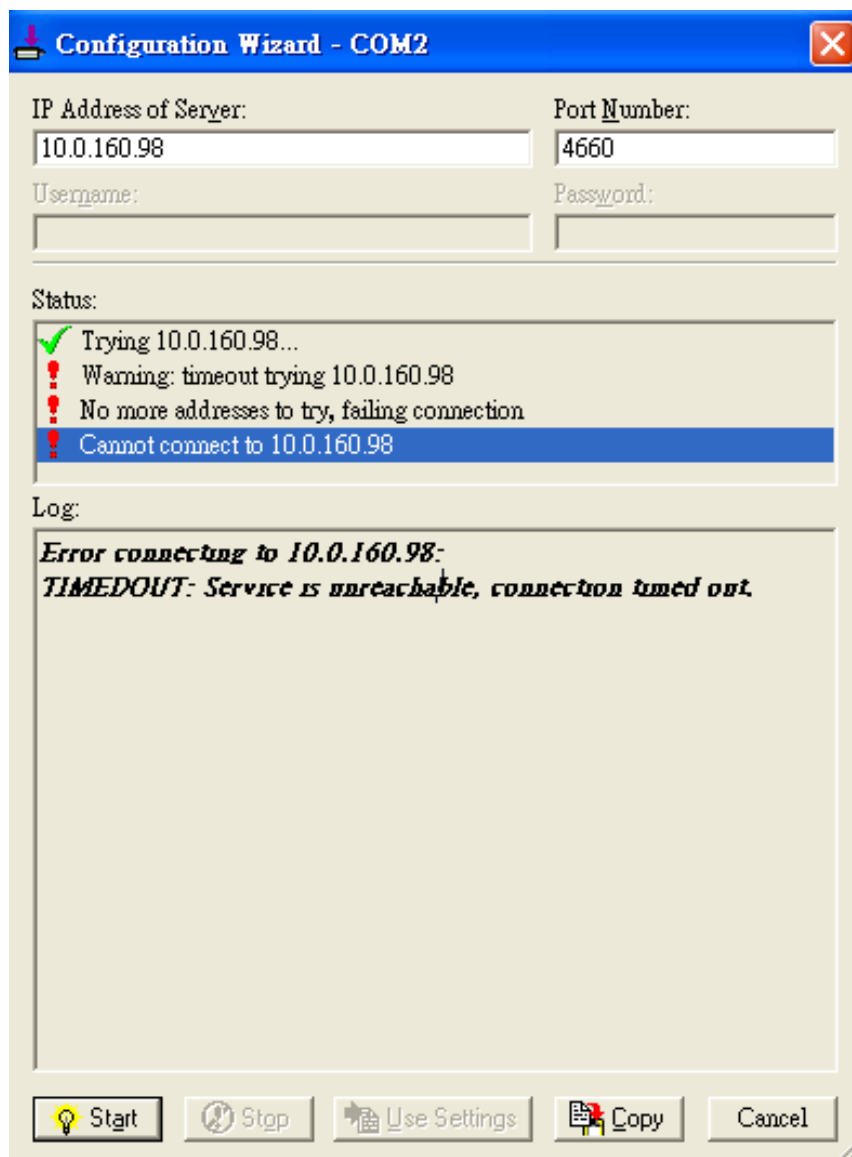

Figure 6.11 Timeout Warning on VCOM Connection

- If the status reports with a check with a message “Raw TCP Connection Detected” and an exclamation mark with a message “Client not licensed for this server” as shown in Figure 6.12. Please enable the Virtual COM option in the serial Device server.

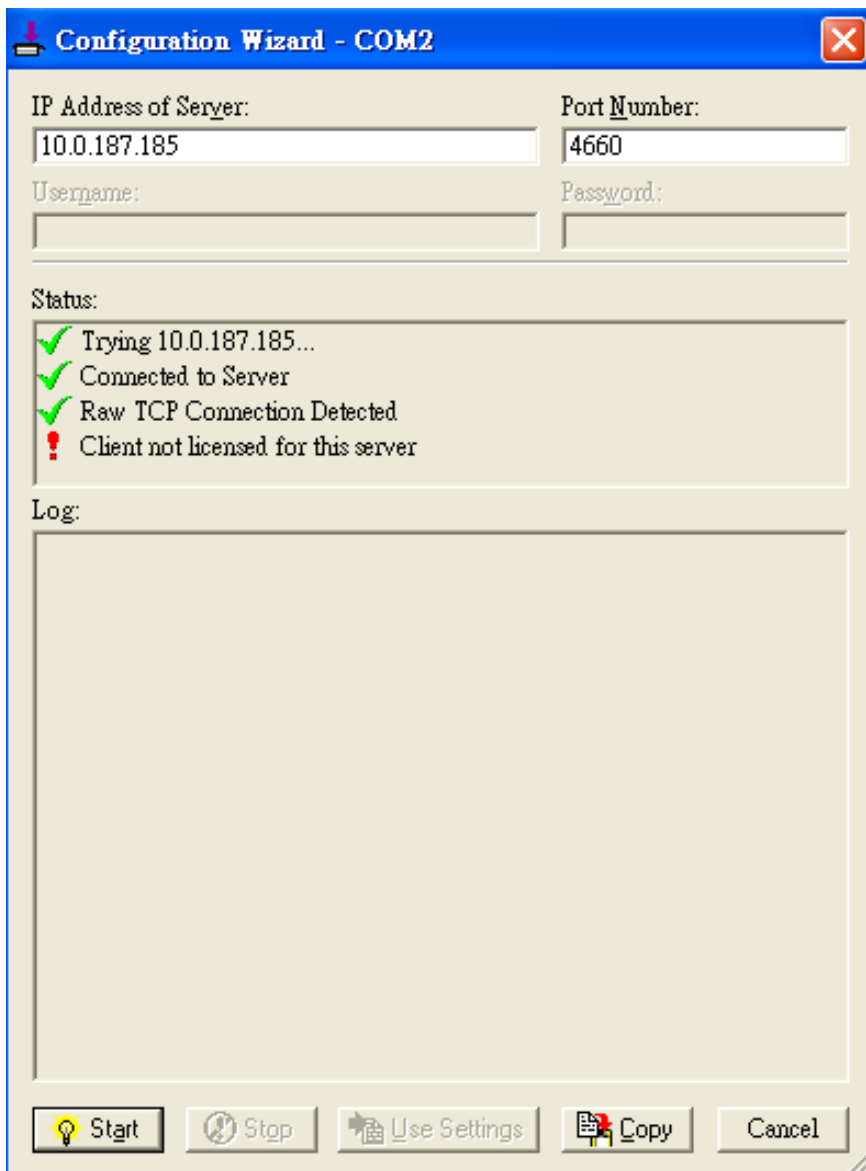

Figure 6.12 Error of Client not licensed for this server

- If the status reports with a check with a message “Telnet Protocol Detected” and an exclamation mark with a message “Client not licensed for this server” as shown in Figure 6.13. This means that there is a licensing issue between the serial gateway (i.e. SE5201) and the Serial/IP Utility Software. Please contact Atop technical support to obtain the correct VCOM software.

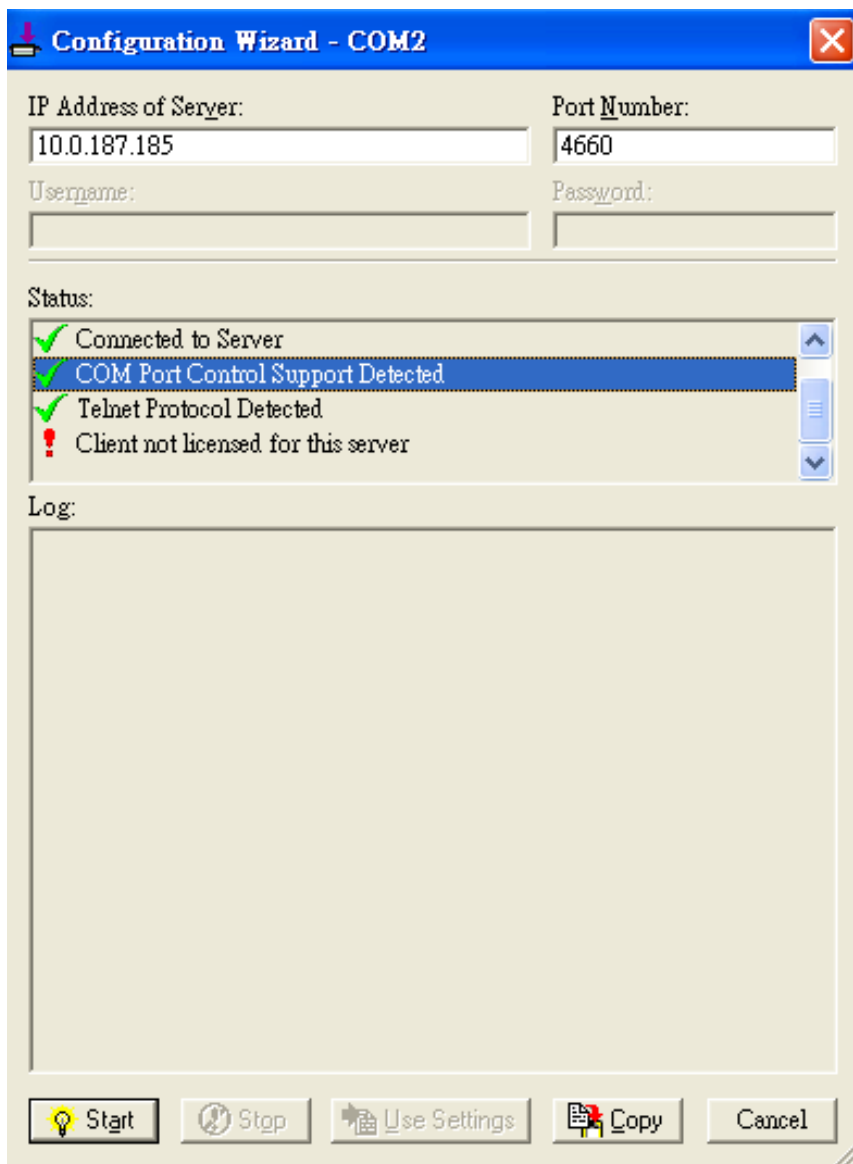

Figure 6.13 Licensing Issue of Serial/IP Utility Software

- If the status reports with an exclamation mark with a message “**Server requires username/password login**” as shown in Figure 6.14. This means that the **VCOM Authentication** option in the serial device server (i.e. SE5201) is enabled but the **User Credentials** option in the **Serial/IP** utility software is not enabled. Please follow the steps in Section 4.11.2 for enabling the user credentials option and entering the username and the password.

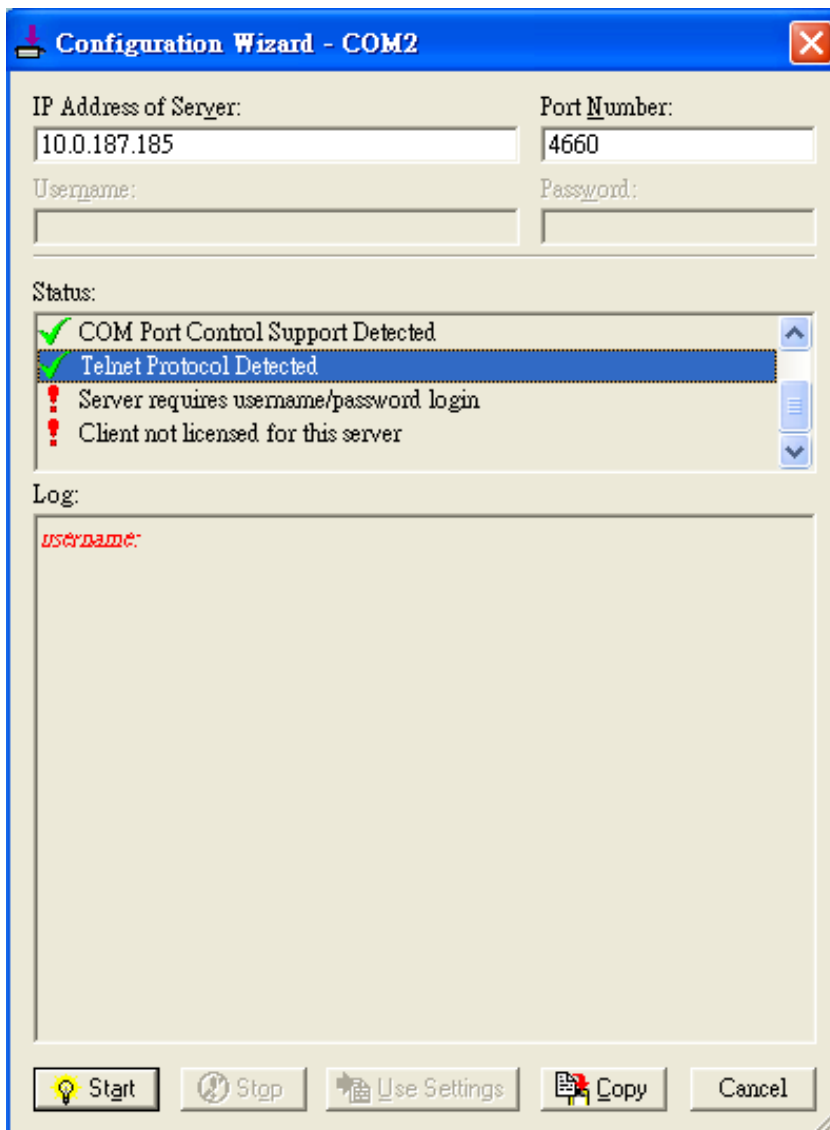

Figure 6.14 VCOM Authentication failed due to Missing Username/Password

- If the status reports with an exclamation mark with a message “**Username and/or password incorrect**” as shown in Figure 6.15. This means that the wrong username and/or password were entered and the authentication process failed.

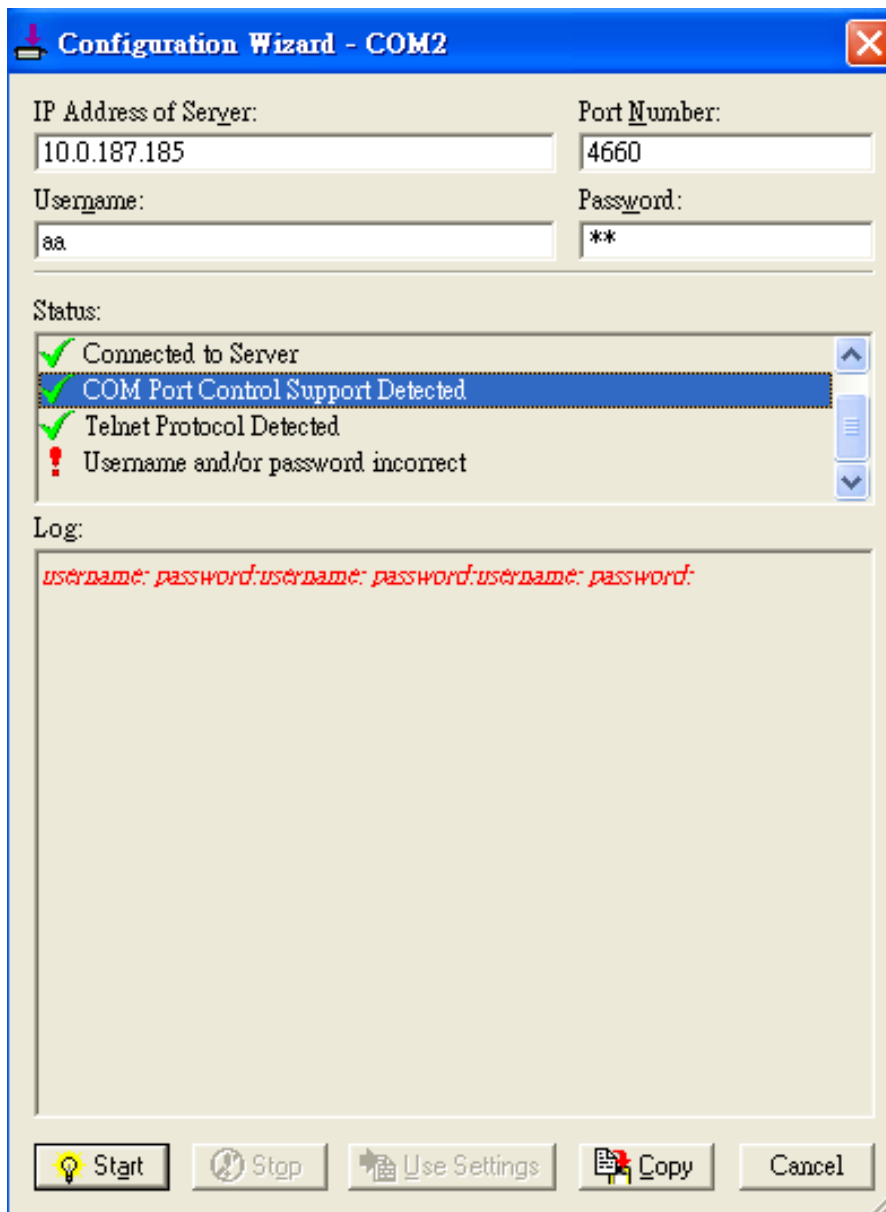

Figure 6.15 VCOM Authentication failed due to incorrect Username and/or Password

- If the status reports with an exclamation mark with a message “**No login/password prompts received from server**” as shown in Figure 6.16. This means that the **User Credentials** option in the Serial/IP utility software is enabled but the VCOM Authentication option in the serial device server (i.e. SE5201) is not enabled. Please enable the **VCOM Authentication** option on the device by setting a new and non-blank administrator’s Username and Password as described in Section 4.11.2. Note that the **Username** and the **Password** for VCOM authentication are the same username and password of the Web UI login. The default account, which has the username as “admin” and the password as “default”, is considered as an unsecured account or no authentication option.

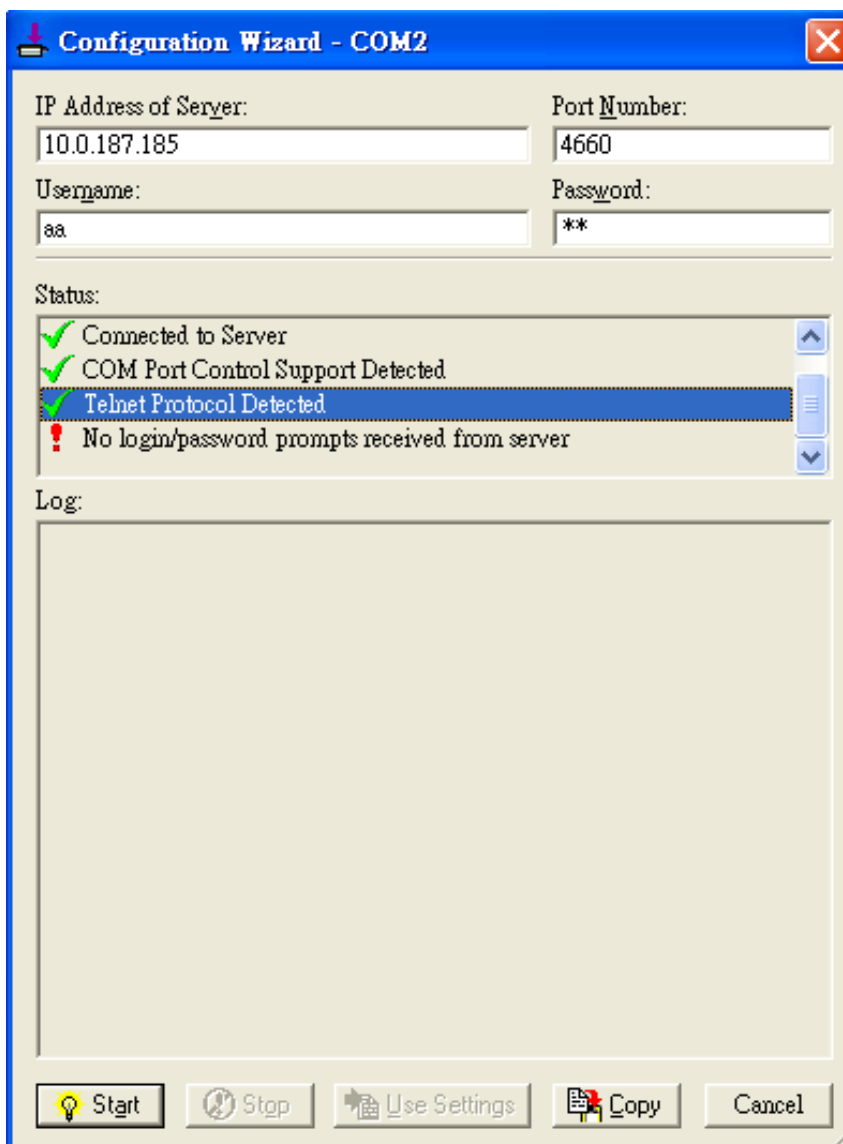

Figure 6.16 VCOM Authentication failed due to disabled VCOM Authentication

6.4 Using Serial/IP Port Monitor

Serial/IP Port Monitor is another utility software provided for Atop's user. It allows user to monitor the activities or status of Virtual COM port and display the exchanged serial message which is called trace over the port.

6.4.1 Opening the Port Monitor

The Serial/IP Port Monitor utility can be opened by one of the following methods:

- Click on Windows's Start menu → Select All Programs → Select Serial-IP → Select Port Monitor.
- Double click the Serial/IP tray icon in the Windows' notification area.
- In the Windows' notification area, right click on the Serial/IP tray icon and click on Port Monitor to open the Port Monitor.
- Click on the Port Monitor button in the Serial/IP Control Panel's window.

6.4.2 The Activity Panel

The **Activity** panel provides a real-time display of the status of all Serial/IP COM ports as shown in Figure 6.17. If the Virtual COM Port is opened and is properly configured to connect to a serial device server (i.e. SE5201), the status would be **Connected**. If Serial/IP utility software cannot find the specified serial device server, the status would be **Offline**.

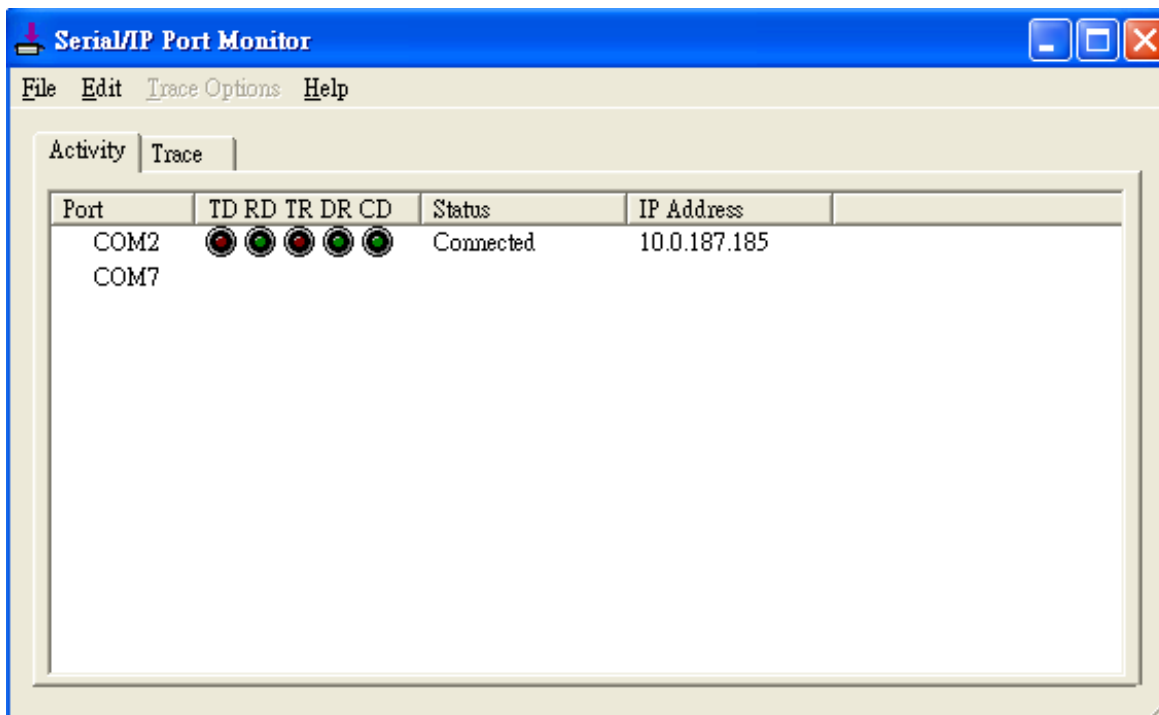

Figure 6.17 Activity Panel of Serial/IP Port Monitor

Each column in the **Activity Panel** is described as follows:

- **Port:** This is the virtual COM port number.
- **Line signal indicators:** Red color means no activity while green color indicates activity.
 - **TD** indicates data are being sent to the server.

- **RD** indicates data are being received from the server.
- **TR** (DTR) is the signal from the application to the server that the application has opened the virtual COM port. The most common use of DTR is to programmatically lower it to signal a modem to disconnect.
- **DR** (DSR) is the signal from the server to the application that a modem or serial device is connected to the server and ready to communicate.
- **CD** (DCD) is the signal from the server to the application that a modem has successfully negotiated a connection with another device.

■ **Status:** This indication the connection status of the software and serial device server which can be **connected** or **offline**.

■ **IP Address:** This is the IP address of the serial device server.

Notes:

- The line signal indicators appear only when the virtual COM port is currently opened by an application.
- The TR, DR, and CD indicators appear only if the COM Port Control protocol is being used or if the COM port options are enabled.

6.4.3 The Trace Panel

The **Trace** panel provides a detailed, time-stamped, real-time display of all Serial/IP COM ports operations as shown in Figure 6.18. Click on **Enable Trace** box to start logging Virtual COM communication. To stop logging, uncheck the **Enable Trace** box. The user can toggle the format of the display between ASCII text (more readable) and hexadecimal format (most detailed) by checking the **Hex Display** box. Click on **Auto Scroll** box will cause the display to show the most recent trace data continuously. To ensure that **Port Monitor**'s window is always on top of other application's windows, please check the **Always on Top** box. If you want to clear the displayed data in **Trace** panel, click on the **Clear** button.

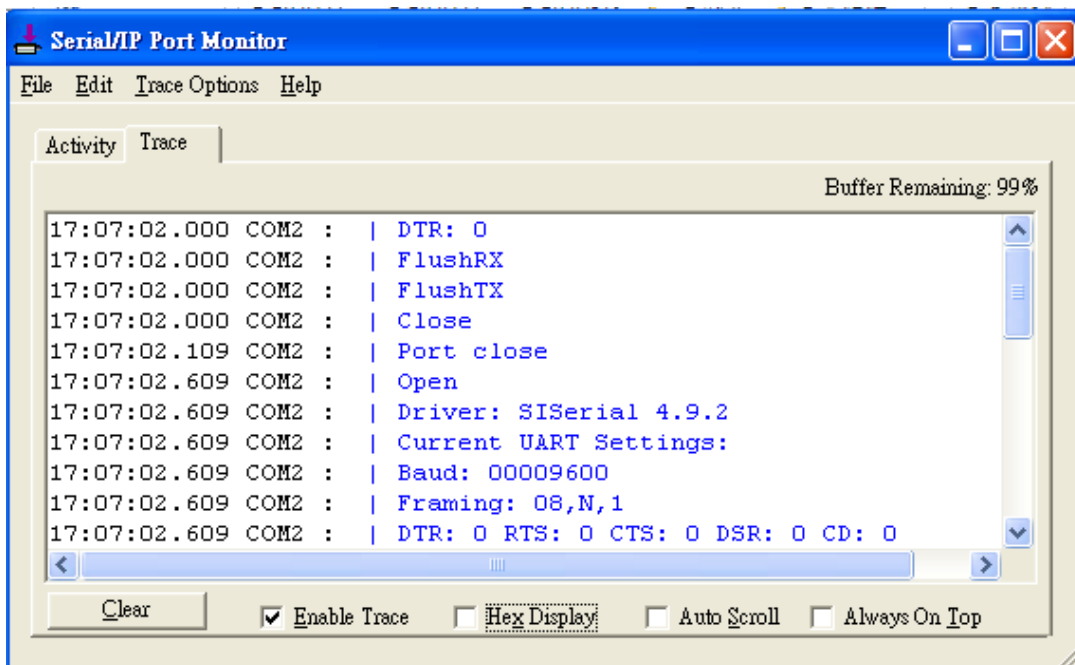

Figure 6.18 Trace Panel of Serial/IP Port Monitor

The pull-down menu of the **Port Monitor** windows allows the user to save the log and customize the capturing data of serial communication.

- **File:** To save the log file which you can send the log to Atop for further analysis if problems occurs with the Virtual COM connection, please click on **File** menu then click **Save As**.
- **Trace Options:**
 - **Select Ports to Capture...:** This menu allows you to reduce the number of ports that are being traced to a subset of all configured Virtual COM ports. This feature can reduce the impact of tracing on memory and system performance for large applications.
 - **Select Ports to Display...:** This menu allows you to reduce the number of ports that appear in the display to a subset of the ports being captured. For large applications, this feature provides a way to focus on ports of interest among all those being captured.
 - **Buffer Size:** This menu allows the change on the amount of RAM being used for tracing which can be normal or large.
 - **System Debug Output:** This menu allows user to enable the sending of trace data to the system debug channel and optionally put a label on them.

The **Trace** panel shows one serial event per line and in time order. Every event begins with a time tag. The transmit events will be shown in green and preceded by "»" while the receive event will be shown in red and preceded by "«". The control events will be shown in blue and preceded by "I".

Notes:

- The **Trace** display covers up to 512k bytes of event data which is enough to cover a reasonably extensive tracing session. However, if the limit is reached, the trace clears and starts over.

6.5 Serial/IP Advanced Settings

In the **Serial/IP Control Panel**, you can click on the **Advanced...** button to open **Serial/IP Advanced Settings** window as shown in Figure 6.19. The **Serial/IP Advanced Settings** window contains two tabs: **Options** and **Proxy Server**. On the **Options** tab, you can click on **Use Default Settings** button to load the default settings. Detail description of each options and how to set a proxy server will be explained in the following subsections.

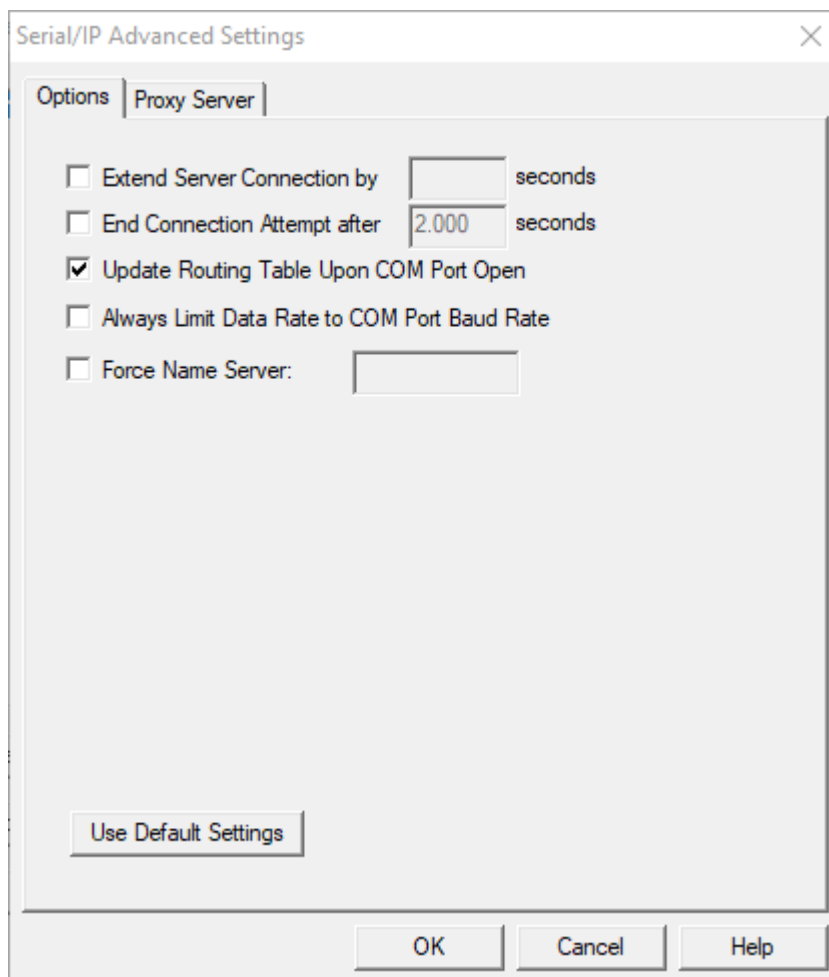

Figure 6.19 Serial/IP Advanced Settings Window

6.5.1 Advanced Setting Options

Under the **Options** tab, you can enable a number of advanced settings and enter required parameters for Serial/IP software. Description of each option is provided as follows.

- **Extend Server Connection:** When enabled, this option maintains the TCP connection for specified amount of time after COM port is closed. The default time value is 8000 milliseconds.
- **End Connection Attempt after:** When enabled, this option terminates pending connection attempts if they do not succeed in the specified time. The default time value is 2000 milliseconds.
- **Update Routing Table Upon COM Port Open:** When enabled, this option maintains IP route to a server in a different subnet by modifying the IP routing table.

- **Always Limit Data Rate to COM Port Baud Rate:** When enabled, this option limits the data rate to the baud rate that is in effect for the virtual COM port.
- **Force Name Server:** This option allows the user to enter the desired Name Server IP address.

6.5.2 Using Serial/IP with a Proxy Server

The **Serial/IP Redirector** also supports TCP network connections made through a proxy server, which may be controlling access to external networks (such as the Internet) from a private network that lacks transparent IP-based routing, such as Network Address Translation (NAT). You can enable Serial/IP support of Virtual COM port through the proxy server using **Serial/IP Proxy Server settings**. You can find **Proxy Server** settings from the **Advanced Settings** windows and click on the **Proxy Server** tab as shown in

Figure 6.20. To enable the use of proxy server, check the box in front of **Use a Proxy Server** option. Then, select the **Protocol Type** which can be **HTTPS** or **Socks V4** or **Socks V5** from a drop-down list. Then, enter the IP address of the proxy server in the text box under **IP Address of Server** field and specify the **Port Number**. Note that the default port number for **HTTPS** is 8080, while for **Socks V4** and **V5** is 1080. Optionally, you can enter the **Username** and **Password** which may be required by your proxy server in the **Login to Server Using** box. Alternately, you can click on the **Auto Detect** button to have the software automatically detect the proxy server settings for you. Finally, you can test the proxy server settings by clicking on the **Test** button and stop the testing by clicking on **Stop** button.

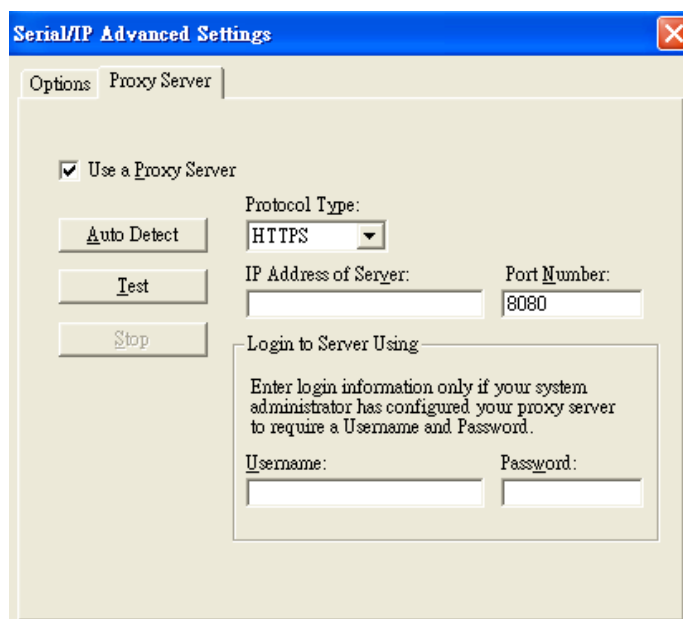

Figure 6.20 Proxy Server Tab under Serial/IP Advanced Settings

7 Specifications

7.1 Hardware

Table 7.1 Hardware Specification

System			
CPU	32-bit ARM Based		
Flash Memory	16MB		
RAM	Integrated DDR2 64MB		
EEPROM	8 KB		
Reset	Built-in Recessed Key (Restore to Factory Defaults)		
Watchdog	Hardware built-in		
Network			
Ethernet Interface	IEEE 802.3 10BaseT IEEE 802.3u 100BaseT(X) Auto-negotiation Auto MDI/MDI-X Connection: RJ45 x 1		
Protocol	ICMP TCP UDP IPv4 HTTP Syslog	DNS DHCP Client SNMPv1, v2c, v3	SMTP NTP ARP Telnet RFC2217
Serial			
Serial Interface	RS-232/RS-422/RS-485 Software Selectable (Default: RS-232)		
Serial Connector	SE5201-SE5201C: 1 Serial Port (TB-5 or DB-9) SE5202: 2 Serial Ports (TB-5 or DB-9)		
Serial Port Communication	Baud-rate: 1200 bps ~ 230,400 bps (RS-485 4-wire allows up to 921,600 bps) Parity: None, Even, Odd, Mark, or Space Data Bits: 5, 6, 7, 8 Stop Bits: 1, 2 Software Selectable Flow Control: RTS/CTS (RS-232 only), XON/XOFF, None		
LED Indicator			
LED indication	RUN x 1 LAN x 1 COM x 1		
Power Requirement & EMC			
Input	3-Pin 5.08mm Lockable Terminal Block: 9-30VDC (SE5201/SE5202 only) SE5201/SE5201C/SE5202: DC Jack 5VDC		
Consumption	Max. 1.5W		
EMI/EMC	FCC Part 15, Subpart B, Class A, EN 55032, EN 61000-3-2, EN 61000-3-3, EN 55024,		

	SE5201-SE5202 only : EN61000-6-4, EN61000-6-2	
Mechanical		
Dimensions (W x H x D, mm)	65mm x 78mm x 28mm (without wall-mount part) SE5201-TB: 88.5 x 78.3 x 27.8mm (with wall-mount part) SE5201-DB: 88.5 x 84 x 27.8mm (with wall-mount part and DB9 connector)	
Enclosure	IEC/EN60529 - IP30 protection, metal housing	
Environmental		
Temperature	Operations	-40°C ~ 70°C (-40°F ~ 158°F)
	Storage	-40°C ~ 85°C (-40°F ~ 185°F)
Relative Humidity	5% ~ 95%, 55°C Non-condensing	

7.2 Serial port Pin Assignments

7.2.1 Pin Assignments for Serial Interfaces

DB9 to RS-232/RS-422/RS-485 connectors

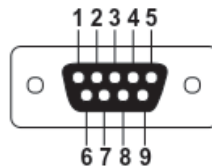

Figure 7.1 DB9 Pin Number

Table 7.2 SE5201/SE5201C Pin Assignment for DB9 to RS-232/RS-422/RS-485 Connector

Pin#	RS-232 Full Duplex	RS-422/4-Wire RS-485 Full Duplex	2-Wire RS-485 Half Duplex
1	DCD	N/A	N/A
2	RxD	TXD+	Data+
3	TxD	RXD+	N/A
4	DTR	N/A	N/A
5	SG (Signal Ground)	SG (Signal Ground)	SG (Signal Ground)
6	DSR	N/A	N/A
7	RTS	RXD-	N/A
8	CTS	TXD-	Data-
9	RI	N/A	N/A

1 x 5-pin (Male Terminal Block) for RS-232/RS-422/RS485 Connector

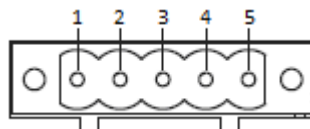

Figure 7.2 TB5 Pin Number

Table 7.3 SE5201/SE5201C Pin Assignment for TB5 to RS-232/RS-422/RS-485 Connector

Pin#	RS-232 Full Duplex	RS-422/4-Wire RS-485 Full Duplex	2-Wire RS-485 Half Duplex
1	RxD	TxD+	Data+
2	CTS	TxD-	Data-
3	TxD	RxD+	NC
4	RTS	RxD-	NC
5	SG (Signal Ground)	SG (Signal Ground)	SG (Signal Ground)

7.3 LED Indicators

Table 7.4 Color Interpretation of LED Indicators

Name	Colour	Status	Message
RUN	● Green	Blinking	System is booted up and AP Firmware is running normally
		On	System is booted up and not running AP Firmware
		Off	System is still booting up or powered off
LAN	● Orange (Speed)	Blinking	Ethernet is transmitting at 10 Mbps
		Off	No Transmission
	● Green (Data)	Blinking	Ethernet data is transmitting at 100 Mbps
		Off	No Transmission
COM	● Green	Blinking	COM is transmitting/receiving
		Off	COM is not transmitting/receiving

7.4 Software

Table 7.5 Software Tools and Utilities

Software	
Utility	Windows Virtual COM Driver and Linux TTY Driver: Linux 2.4.x, Linux 2.6.x, 3.x
Configuration Tool	<ul style="list-style-type: none"> ■ Web console ■ Serial console ■ SSH console ■ Telnet console ■ Device Management Utility©

8 Emergency System Recovery

If the device becomes inaccessible and the management utility cannot find the device, please use the following procedure to recover the devices over Trivial File Transfer Protocol (TFTP).

8.1 System Recovery Procedures

System recovery is based on the TFTP Client embedded in the device. It can recover the device from a bad firmware or other unknown reasons corrupting the firmware image inside the flash memory. Please follow the procedures below to force the device to download a valid firmware from the TFTP Server to recover its operating system.

Table 8.1 Default Settings for System Recovery Procedure

Default Settings	
TFTP Server	10.0.50.201
TFTP Server Subnet Mask	255.255.0.0
Name of firmware Image*	firmware.dld
*This firmware image can be obtained from Atop's website.	

- If the device is beeping continuously after power up, this means that the bootloader is damaged and there is no way to recover it. Please contact Atop directly to obtain RMA number for further solutions.
- Obtain and setup a TFTP server on your PC. Make sure that the PC's network settings are set properly according to the default setting in the above table.
- Rename the firmware image that you obtained from our website to "firmware.dld" and place it in the TFTP Server's root directory. For Solarwinds TFTP Server, it is usually C:\TFTP-Root.
- Make sure that the device is powered OFF and the Ethernet cable is plugged in.
- Press and hold the "**Reset**" button above the USB port then power ON the device. If the bootloader is still functioning, the user will hear one long beep followed by two shorter beeps.
- Release the reset pin after hearing seven consecutive short beeps. Then, the device will automatically request files from TFTP Server. Please wait until the device shows up on the Device Management Utility. This process could take up to five minutes or even more.

Important Note

Free TFTP Servers can be downloaded from the following locations:

Solarwinds TFTP Server	http://www.solarwinds.com/products/freetools/free_tftp_server.aspx
Note: for Solarwinds, please remember to Start the TFTP Server Service, the default state of the TFTP is Stop.	
TFTPD32 TFTP Server	http://tftpd32.jounin.net/tftpd32.html

9 Warranty

Limited Warranty Conditions

Products supplied by Atop Technologies Inc. are covered in this warranty for undesired performance or defects resulting from shipping, or any other event deemed to be the result of Atop Technologies Inc. mishandling. The warranty does not cover; however, equipment which has been damaged due to accident, misuse, abuse, such as:

- Use of incorrect power supply, connectors, or maintenance procedures
- Use of accessories not sanctioned by us
- Improper or insufficient ventilation
- Improper or unauthorized repair
- Replacement with unauthorized parts
- Failure to follow our operating Instructions
- Fire, flood, "Act of God", or any other contingencies beyond our control.

RMA and Shipping Reimbursement

- Customers must always obtain an authorized "**RMA**" number from us before shipping the goods to be repaired.
- When in normal use, a sold product shall be replaced with a new one within 3 months upon purchase. The shipping cost from the customer to us will be reimbursed.
- After 3 months and still within the warranty period, it is up to us whether to replace the unit with a new one; normally, as long as a product is under warranty, all parts and labour are free-of-charge to the customers.
- After the warranty period, the customer shall cover the cost for parts and labour.
- Three months after purchase, the shipping cost from the customer to us will not be reimbursed, but the shipping costs from us to the customer will be paid by us.

Limited Liability

Atop Technologies Inc. shall not be held responsible for any consequential losses from using our products.

Warranty

Atop Technologies Inc. provides a 5-year maximum warranty for Industrial Serial Device Server products.



Atop Technologies, Inc.

www.atoponline.com

TAIWAN HEADQUARTER:

2F, No. 146, Sec. 1, Tung-Hsing Rd,
30261 Chupei City, Hsinchu County
Taiwan, R.O.C.
Tel: +886-3-550-8137
Fax: +886-3-550-8131

ATOP CHINA BRANCH:

3F, 75th, No. 1066 Building,
Qingzhou North Road,
Shanghai, China
Tel: +86-21-64956231

ATOP INDIA OFFICE:

Abhishek Srivastava
Head of India Sales
Atop Communication Solution(P) Ltd.
No. 311, 6th Main Rd, Indiranagar,
Bangalore, 560038, India
Tel: +91-80-4920-6363
E-mail: Abhishek.S@atop.in

ATOP INDONESIA BRANCH:

Jopson Li
Branch Director
Wisma Lampung Jl.
No. 40, Tomang Raya
Jakarta, Barat, 11430, Indonesia
Tel: +62-857-10595775
E-mail: jopsonli@atop.com.tw

ATOP EMEA OFFICE:

Prashant Mishra
Business Development (EMEA)
Atop Communication Solution(P) Ltd.
No. 311, 6th Main Rd, Indiranagar,
Bangalore, 560038, India
Tel: +91-738-702-0003
E-mail: prashant.m@atop.in

ATOP AMERICAs OFFICE:

Venke Char
Sr. Vice President & Head of Business
11811 North Tatum Blvd, Suite 3031
Phoenix, AZ 85028,
United States
Tel: +1-602-953-7669
E-mail: venke@atop.in