

Power relays 16 A



Road / tunnel lighting



Industrial furnaces and ovens



Burners, boilers and furnaces



Control and management of electric power



Punches, cleaners, planers and sanders



Control panels



Circuit breakers and switches



Industrial motors

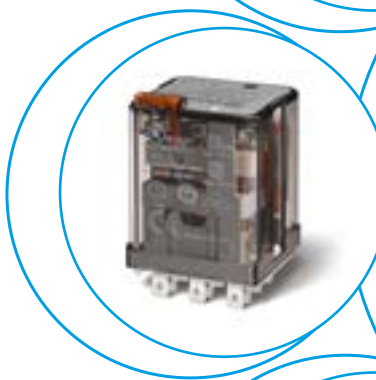

**Printed circuit mount
16 A Power relay**

- 2 & 3 Pole changeover contacts or NO (≥ 3 mm contact gap)
- AC coils & DC coils
- Reinforced insulation between coil and contacts according to EN 60335-1, with 6 mm clearance & 8 mm creepage distance
- SELV coil-contact separator option
- Cadmium free contact material options

62.22/62.23



- 2 & 3 pole changeover contact
- PCB mount

62.22-0300/62.23-0300



- 2 & 3 pole normally open contact (≥ 3 mm contact gap)
- PCB mount

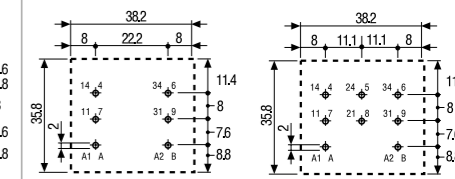
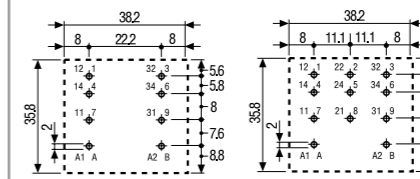
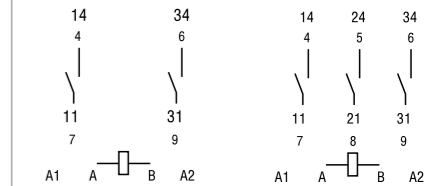
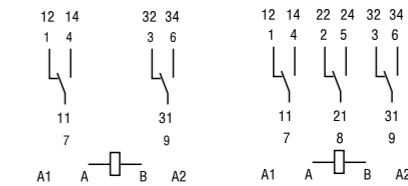

62.22
Copper side view

62.23
Copper side view

62.22 - 0300
Copper side view

62.23 - 0300
Copper side view

* Distance between contacts ≥ 3 mm (EN 60730-1).
** With the AgSnO₂ material the maximum peak current is 120 A - 5 ms (NO contact).

FOR UL RATINGS SEE:
"General technical information" page V

For outline drawing see page 12

Contact specification

Contact configuration		2 CO (DPDT)	3 CO (3PDT)	2 NO (DPST-NO), ≥ 3 mm*	3 NO (3PST-NO), ≥ 3 mm*
Rated current/Maximum peak current	A	16/30**		16/30**	
Rated voltage/Maximum switching voltage	V AC	250/400		250/400	
Rated load AC1	VA	4000		4000	
Rated load AC15 (230 V AC)	VA	750		750	
Motor rating (230/400 V AC)	kW	0.8/—	0.8/1.5	0.8/—	0.8/1.5
Breaking capacity DC1: 24/110/220 V	A	16/0.6/0.4		16/1.1/0.7	
Minimum switching load	mW (V/mA)	1000 (10/10)		1000 (10/10)	
Standard contact material		AgCdO		AgCdO	

Coil specification

Nominal voltage (U _N)	V AC (50/60 Hz)	6 - 12 - 24 - 48 - 60 - 110 - 120 - 230 - 240 - 400			
	V DC	6 - 12 - 24 - 48 - 60 - 110 - 125 - 220			
Rated power AC/DC	VA (50 Hz)/W	2.2/1.3		3/3	
Operating range	AC	(0.8...1.1)U _N		(0.85...1.1)U _N	
	DC	(0.8...1.1)U _N		(0.85...1.1)U _N	
Holding voltage	AC/DC	0.8 U _N / 0.6 U _N		0.8 U _N / 0.6 U _N	
Must drop-out voltage	AC/DC	0.2 U _N / 0.1 U _N		0.2 U _N / 0.1 U _N	

Technical data

Mechanical life AC/DC	cycles	10 · 10 ⁶ /30 · 10 ⁶		10 · 10 ⁶ /30 · 10 ⁶	
Electrical life at rated load AC1	cycles	100 · 10 ³		100 · 10 ³	
Operate/release time	ms	11/4		15/3	
Insulation between coil and contacts (1.2/50 μs)	kV	6		6	
Dielectric strength between open contacts	V AC	1500		3000	
Ambient temperature range	°C	-40...+70		-40...+50	
Environmental protection		RT I		RT I	

Approvals (according to type)



Prices, features, specifications, capabilities, appearance and availability of our products and services are subject to change without notice. FINDER assumes no responsibility for the presence of possible errors or insufficient information in this document. In case of discrepancies between the printed and online versions, the latter prevails.

A

**Plug-in mount/Faston 187
16 A Power relay**

- Plug-in (92 series sockets) or Faston 187 (4.8 x 0.5 mm) with optional mounting adaptors
- 2 & 3 Pole changeover contacts or NO (≥ 3 mm contact gap)
- AC coils & DC coils
- UL Listing (certain relay/socket combinations)
- LED, mechanical indicator & test button options
- Reinforced insulation between coil and contacts according to EN 60335-1, with 6 mm clearance & 8 mm creepage distance
- SELV coil-contact separator option
- Cadmium free contact material options
- Sockets and accessories
- European Patent

* Distance between contacts ≥ 3 mm (EN 60730-1).
** With the AgSnO₂ material the maximum peak current is 120 A - 5 ms (NO contact).

For UL RATINGS SEE:
"General technical information" page V
For outline drawing see page 12

Contact specification

Contact configuration	2 CO (DPDT)	3 CO (3PDT)	2 NO (DPST-NO), ≥ 3 mm*	3 NO (3PST-NO), ≥ 3 mm*
Rated current/Maximum peak current	A 16/30**		A 16/30**	
Rated voltage/Maximum switching voltage	V AC 250/400		V AC 250/400	
Rated load AC1	VA 4000		VA 4000	
Rated load AC15 (230 V AC)	VA 750		VA 750	
Motor rating (230/400 V AC)	kW 0.8/—		kW 0.8/—	
Breaking capacity DC1: 24/110/220 V	A 16/0.6/0.4		A 16/1.1/0.7	
Minimum switching load	mW (V/mA) 1000 (10/10)		mW (V/mA) 1000 (10/10)	
Standard contact material	AgCdO		AgCdO	

Coil specification

Nominal voltage (U _N)	V AC (50/60 Hz)	6 - 12 - 24 - 48 - 60 - 110 - 120 - 230 - 240 - 400	V DC	6 - 12 - 24 - 48 - 60 - 110 - 125 - 220
Rated power AC/DC	VA (50 Hz)/W	2.2/1.3	3/3	
Operating range	AC	(0.8...1.1)U _N	(0.85...1.1)U _N	
	DC	(0.8...1.1)U _N	(0.85...1.1)U _N	
Holding voltage	AC/DC	0.8 U _N / 0.6 U _N	0.8 U _N / 0.6 U _N	
Must drop-out voltage	AC/DC	0.2 U _N / 0.1 U _N	0.2 U _N / 0.1 U _N	

Technical data

Mechanical life AC/DC	cycles	10 · 10 ⁶ /30 · 10 ⁶	10 · 10 ⁶ /30 · 10 ⁶	
Electrical life at rated load AC1	cycles	100 · 10 ³	100 · 10 ³	
Operate/release time	ms	11/4	15/3	
Insulation between coil and contacts (1.2/50 μs)	kV	6	6	
Dielectric strength between open contacts	V AC	1500	3000	
Ambient temperature range	°C	-40...+70	-40...+50	
Environmental protection		RT I	RT I	

Approvals (according to type)

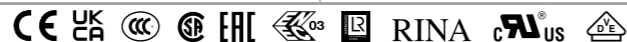

62.32/62.33



- 2 & 3 pole changeover contact
- Plug-in/Faston 187

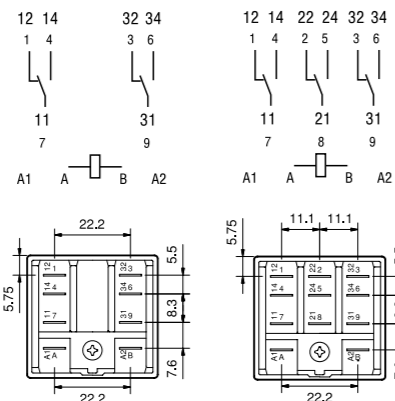

62.32

62.33

62.32-0300/62.33-0300



- 2 & 3 pole normally open contact (≥ 3 mm contact gap)
- Plug-in/Faston 187

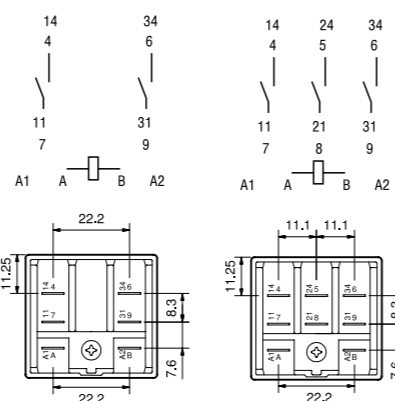

62.32-0300

62.33-0300

I-2023, www.findernet.com

A

**Flange mount/Faston 250
16 A Power relay**

- Faston 250 (6.3 x 0.8 mm) termination Flange or optional mounting adaptors
- 2 & 3 Pole changeover contacts or NO (≥ 3 mm contact gap)
- AC coils & DC coils
- LED, mechanical indicator & test button options
- Reinforced insulation between coil and contacts according to EN 60335-1, with 6 mm clearance & 8 mm creepage distance
- SELV coil-contact separator option
- Cadmium free contact material options
- European Patent

* Distance between contacts ≥ 3 mm (EN 60730-1).
** With the AgSnO₂ material the maximum peak current is 120 A - 5 ms (NO contact).

For UL RATINGS SEE:
"General technical information" page V
For outline drawing see page 12

Contact specification

Contact configuration	2 CO (DPDT)	3 CO (3PDT)	2 NO (DPST-NO), ≥ 3 mm*	3 NO (3PST-NO), ≥ 3 mm*
Rated current/Maximum peak current	A 16/30**		A 16/30**	
Rated voltage/Maximum switching voltage	V AC 250/400		V AC 250/400	
Rated load AC1	VA 4000		VA 4000	
Rated load AC15 (230 V AC)	VA 750		VA 750	
Motor rating (230/400 V AC)	kW 0.8/—		kW 0.8/—	
Breaking capacity DC1: 24/110/220 V	A 16/0.6/0.4		A 16/1.1/0.7	
Minimum switching load	mW (V/mA) 1000 (10/10)		mW (V/mA) 1000 (10/10)	
Standard contact material	AgCdO		AgCdO	

Coil specification

Nominal voltage (U _N)	V AC (50/60 Hz)	6 - 12 - 24 - 48 - 60 - 110 - 120 - 230 - 240 - 400	V DC	6 - 12 - 24 - 48 - 60 - 110 - 125 - 220
Rated power AC/DC	VA (50 Hz)/W	2.2/1.3	3/3	
Operating range	AC	(0.8...1.1)U _N	(0.85...1.1)U _N	
	DC	(0.8...1.1)U _N	(0.85...1.1)U _N	
Holding voltage	AC/DC	0.8 U _N / 0.6 U _N	0.8 U _N / 0.6 U _N	
Must drop-out voltage	AC/DC	0.2 U _N / 0.1 U _N	0.2 U _N / 0.1 U _N	

Technical data

Mechanical life AC/DC	cycles	10 · 10 ⁶ /30 · 10 ⁶	10 · 10 ⁶ /30 · 10 ⁶	
Electrical life at rated load AC1	cycles	100 · 10 ³	100 · 10 ³	
Operate/release time	ms	11/4	15/3	
Insulation between coil and contacts (1.2/50 μs)	kV	6	6	
Dielectric strength between open contacts	V AC	1500	3000	
Ambient temperature range	°C	-40...+70	-40...+50	
Environmental protection		RT I	RT I	

Approvals (according to type)



I-2023, www.findernet.com

Plug-in mount/Faston 187 Magnetic blow power relay

- Plug-in (92 series sockets) or Faston 187 (4.8 x 0.5 mm) with optional mounting adaptors
- 1 & 2 Pole NO contacts
- High DC load (resistive and inductive) switching capability
- DC coils
- Reinforced insulation between coil and contacts according to EN 60335-1, with 6 mm clearance & 8 mm creepage distance
- Cadmium free contact material
- Sockets and accessories

* Maximum peak current 120 A - 5 ms.

For outline drawing see page 12

Contact specification

Contact configuration	62.31-4800	62.32-4800
Contact configuration	1 NO (SPST-NO) double break, ≥ 4.2 mm	2 NO (DPST-NO), ≥ 2.1 mm
Rated current/Maximum peak current	A 16/30*	16/30*
Rated voltage/Maximum switching voltage	V AC 250/400	250/400
Rated load AC1	VA 4000	4000
Breaking capacity DC1: 24/125/220 V	A 16/16/12	16/12/6
Breaking capacity DC inductive (L/R = 40 ms): 30/125/220 V	A 16/5/3	10/2/1.2
Minimum switching load	mW (V/mA) 1000 (10/10)	1000 (10/10)
Standard contact material	AgSnO ₂	AgSnO ₂

Coil specification

Nominal voltage (U _N)	62.31-4800	62.32-4800
Nominal voltage (U _N)	V DC 6 - 12 - 24 - 48 - 60 - 110 - 125 - 220	
Rated power DC	W 1.3	1.3
Operating range	DC (0.85...1.1)U _N	(0.85...1.1)U _N
Holding voltage	DC 0.6 U _N	0.6 U _N
Must drop-out voltage	DC 0.1 U _N	0.1 U _N

Technical data

Mechanical life DC	cycles	10 · 10 ⁶	10 · 10 ⁶
Electrical life at rated load DC1	cycles	100 · 10 ³	100 · 10 ³
Operate/release time	ms	16/5	16/5
Insulation between coil and contacts (1.2/50 μs)	kV	6	6
Dielectric strength between open contacts	V AC	3000	2000
Ambient temperature range	°C	-40...+70	-40...+70
Environmental protection		RT I	RT I

Approvals (according to type)



62.31-4800



- 1 pole normally open contact (double break, ≥ 4.2 mm contact gap)
- Plug-in/Faston 187

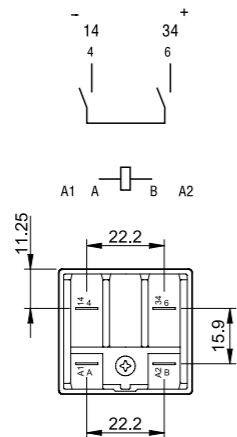

62.31-4800

62.32-4800



- 2 pole normally open contact (≥ 2.1 mm contact gap)
- Plug-in/Faston 187

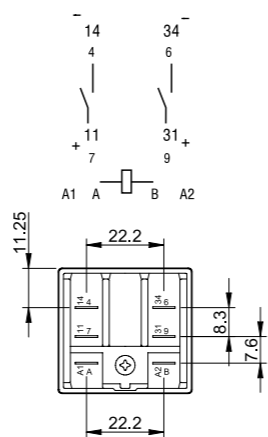

62.32-4800

Ordering information

Example: 62 series power relay + Faston 250 (6.3 x 0.8 mm), rear flange mount, 2 NO (DPST-NO), 12 V DC coil.

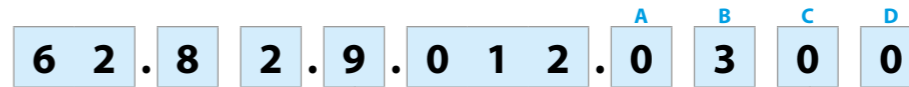

Series

Type

- 2 = PCB
- 3 = Plug-in
- 8 = Faston 250 (6.3 x 0.8 mm) with rear flange mount

No. of poles

- 1 = 1 pole (double break)
- 2 = 2 pole
- 3 = 3 pole

Coil version

- 8 = AC (50/60 Hz)
- 9 = DC

Coil voltage

See coil specifications

A: Contact material

- 0 = Standard AgCdO
- 4 = AgSnO₂ (standard for versions 4800)

B: Contact circuit

- 0 = CO (nPDT)
- 3 = NO (nPST), ≥ 3 mm contact gap
- 5 = CO (nPDT) + additional physical separator between coil and contacts (for SELV applications)
- 6 = NO (nPST), ≥ 3 mm contact gap + additional physical separator between coil and contacts (for SELV applications)
- 8 = NO (1 pole double break or 2 pole) with magnetic blow

D: Special versions

- 0 = Standard
- 6 = Rear flange mount
- 9 = Type 62.82/83 without rear flange mount

C: Options

- 0 = None
- 2 = Mechanical indicator
- 3 = LED (AC)
- 4 = Lockable test button + mechanical indicator
- 5* = Lockable test button + LED (AC)
- 54* = Lockable test button + LED (AC) + mechanical indicator
- 6* = LED + diode (DC, polarity positive to pin A/A1)
- 7* = Lockable test button + LED + diode (DC, polarity positive to pin A/A1)
- 74* = Lockable test button + LED + diode (DC, polarity positive to pin A/A1) + mechanical indicator

* Options not available for 220 V DC and 400 V AC versions.

Selecting features and options: only combinations in the same row are possible.

Preferred selections for best availability are shown in bold.

Type	Coil version	A	B	C	D	
62.22/23	AC-DC	0 - 4	0 - 3 - 5 - 6	0	0	
62.32/33	AC-DC	0 - 4	0 - 3 - 5 - 6	0	0 - 6	
	AC-DC	0 - 4	0 - 5	2 - 4	0 - 6	
	AC	0 - 4	0	2 - 3 - 4 - 5	0 - 6	
	AC	0 - 4	0 - 3	3	0 - 6	
	AC	0 - 4	0	54	/	
	DC	0 - 4	0	4 - 6 - 7	0 - 6	
	DC	0 - 4	0 - 3	6	0 - 6	
62.31/32	DC	4	8	0	0	
	62.82/83	AC-DC	0 - 4	0 - 3 - 5 - 6	0	0 - 9
		AC-DC	0 - 4	0 - 5	2 - 4	0
		AC	0 - 4	0	2 - 3 - 4 - 5	0
		AC	0 - 4	0 - 3	3	0
		DC	0 - 4	0	4 - 6 - 7	0
		DC	0 - 4	0 - 3	6	0

Descriptions: Options and Special versions

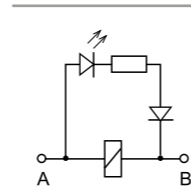

C: Option 3, 5, 54
LED (AC)

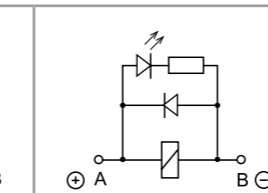

C: Option 6, 7, 74
LED + diode (DC, polarity positive to pin A/A1)



B: Contact circuit 5, 6
Additional physical separator between coil and contacts (for SELV applications)

B: Contact circuit 8
Magnetic blow



Lockable test button and mechanical flag indicator (0040, 0050, 0054, 0070, 0074)

The dual-purpose Finder test button can be used in two ways:

Case 1) The plastic pip (located directly above the test button) remains intact. In this case, when the test button is pushed, the contacts operate. When the test button is released the contacts return to their former state.

Case 2) The plastic pip is broken-off (using an appropriate cutting tool). In this case, (in addition to the above function), when the test button is pushed and rotated, the contacts are latched in the operating state, and remain so until the test button is rotated back to its former position. In both cases ensure that the test button actuation is swift and decisive.



Technical data

Insulation according to EN 61810-1

		2 CO - 3 CO	2 NO - 3 NO	1 NO*	2 NO*
Nominal voltage of supply system	V AC	230/400	230/400	230/400	230/400
Rated insulation voltage	V AC	400	400	400	400
Pollution degree		3	3	3	3

Insulation between coil and contact set

		Reinforced	Reinforced	Reinforced	Reinforced
Type of insulation		Reinforced	Reinforced	Reinforced	Reinforced
Overvoltage category		III	III	III	III
Rated impulse voltage	kV (1.2/50 μs)	6	6	6	6
Dielectric strength	V AC	4000	4000	4000	4000

Insulation between adjacent contacts

		Basic	Basic	—	Basic
Type of insulation		Basic	Basic	—	Basic
Overvoltage category		III	III	—	III
Rated impulse voltage	kV (1.2/50 μs)	4	4	—	4
Dielectric strength	V AC	2500	2500	—	2500

Insulation between open contacts

		Micro-disconnection	Full-disconnection	Full-disconnection	Full-disconnection**
Type of disconnection		Micro-disconnection	Full-disconnection	Full-disconnection	Full-disconnection**
Overvoltage category		—	III	III	II
Rated impulse voltage	kV (1.2/50 μs)	—	4	4	2.5
Dielectric strength	V AC/kV (1.2/50 μs)	1500/2	3000/4	3000/4	2000/2.5

Insulation between coil terminals

Rated impulse voltage (surge) differential mode (according to EN 61000-4-5)	kV (1.2/50 μs)	4
---	----------------	---

Other data

Bounce time: NO/NC	ms	1/5 (changeover)	3/— (normally open)	3/— (normally open)	3/— (normally open)		
Vibration resistance (10...150)Hz: NO/NC	g	20/8					
Shock resistance	g	15					
Power lost to the environment							
		2 pole (CO)	3 pole (CO)	2 pole (NO)	3 pole (NO)	1 pole (NO)*	2 pole (NO)*
without contact current	W	1.3	1.3	3	3	1.3	1.3
with rated current	W	3.3	4.3	5	6	3	3.3
Recommended distance between relays mounted on PCB	mm	≥ 5				—	

* Magnetic blow version

** Only in applications where over voltage category II is permitted. In applications of over voltage category III: Micro-disconnection.

Contact specification

F 62 - Electrical life (AC) v contact current

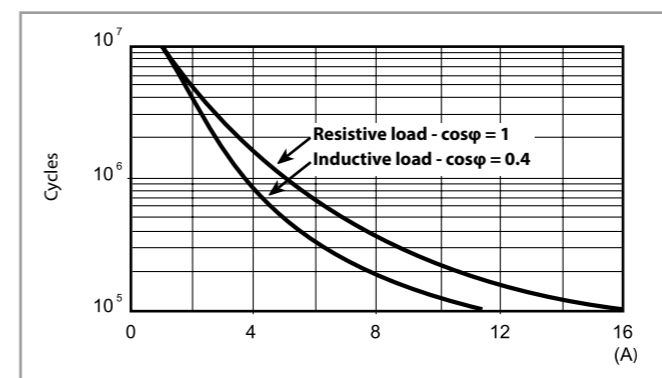

H 62 - Maximum DC1 breaking capacity

Changeover contacts

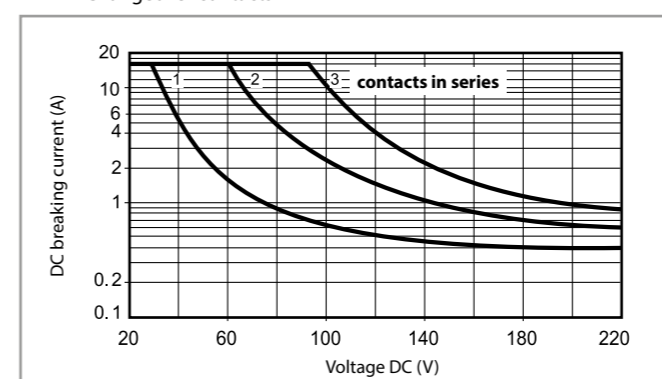

H 62 - Maximum DC1 breaking capacity

Normally open contacts

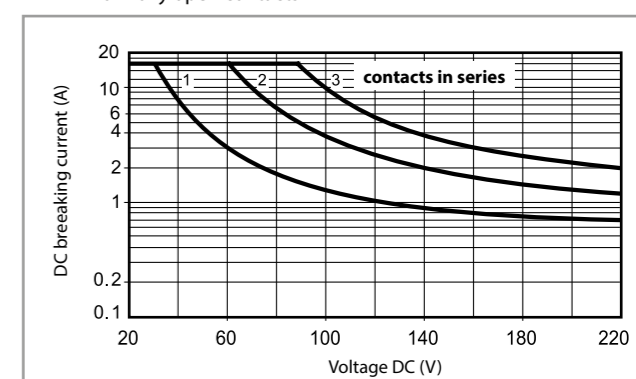

- When switching a resistive load (DC1) having voltage and current values under the curve, an electrical life of $\geq 100 \cdot 10^3$ can be expected.
- In the case of DC13 loads, the connection of a diode in parallel with the load will permit a similar electrical life as for a DC1 load.
Note: the release time of the load will be increased.

H 62 - Maximum DC breaking capacity 62.31.9.xxx.4800

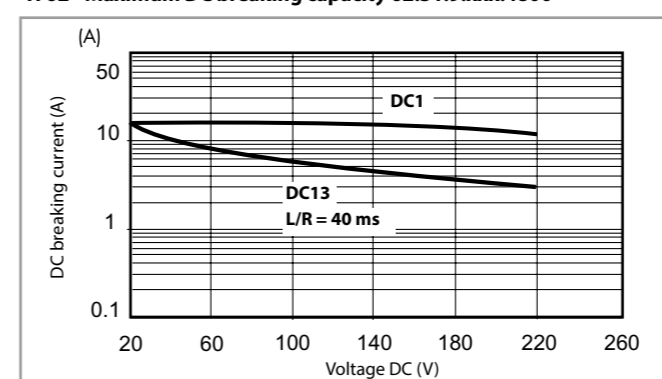

H 62 - Maximum DC breaking capacity 62.32.9.xxx.4800

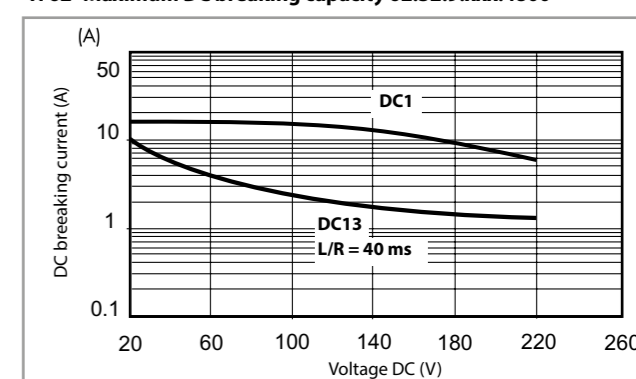

- When switching a resistive load (DC1), or a DC13 load with a diode in parallel to the load, having voltage and current values under the DC1 curve, an electrical life of $\geq 100 \cdot 10^3$ can be expected. Note: the release time for the load will be increased.
- When switching a DC13 load without a diode in parallel to the load, the DC13 curve applies and an electrical life of $\geq 80 \cdot 10^3$ can be expected.

Coil specifications

DC version data

Nominal voltage U_N	Coil code	Operating range		Resistance R	Rated coil consumption I at U_N
		U_{min}	U_{max}		
V		V	V	Ω	mA
6	9.006	4.8	6.6	28	214
12	9.012	9.6	13.2	110	109
24	9.024	19.2	26.4	445	54
48	9.048	38.4	52.8	1770	27
60	9.060	48	66	2760	21.7
110	9.110	88	121	9420	11.7
125	9.125	100	138	12000	10.4
220	9.220	176	242	37300	5.8

DC (NO/nPST-NO) version data - ≥ 3 mm

Nominal voltage U_N	Coil code	Operating range		Resistance R	Rated coil consumption I at U_N
		U_{min}	U_{max}		
V		V	V	Ω	mA
6	9.006	5.1	6.6	12	500
12	9.012	10.2	13.2	48	250
24	9.024	20.4	26.4	192	125
48	9.048	40.8	52.8	770	63
60	9.060	51	66	1200	50
110	9.110	93.5	121	4200	26
125	9.125	106	138	5200	24
220	9.220	187	242	17600	12.5

DC (NO/nPST-NO) magnetic blow version - ≥ 2.1 mm or ≥ 4.2 mm

Nominal voltage U_N	Coil code	Operating range		Resistance R	Rated coil consumption I at U_N
		U_{min}	U_{max}		
V		V	V	Ω	mA
6	9.006	5.1	6.6	28	214
12	9.012	10.2	13.2	110	109
24	9.024	20.4	26.4	445	54
48	9.048	40.8	52.8	1770	27
60	9.060	51	66	2760	21.7
110	9.110	93.5	121	9420	11.7
125	9.125	106	138	12000	10.4
220	9.220	154*	242	37300	5.8

* Special version with $U_{min} = 70\% U_N$

AC version data

Nominal voltage U_N	Coil code	Operating range		Resistance R	Rated coil consumption I at U_N (50Hz)
		U_{min}	U_{max}		
V		V	V	Ω	mA
6	8.006	4.8	6.6	4.6	367
12	8.012	9.6	13.2	19	183
24	8.024	19.2	26.4	74	90
48	8.048	38.4	52.8	290	47
60	8.060	48	66	450	37
110	8.110	88	121	1600	20
120	8.120	96	132	1940	18.6
230	8.230	184	253	7250	10.5
240	8.240	192	264	8500	9.2
400	8.400	320	440	19800	6

AC (NO/nPST-NO) version data - ≥ 3 mm

Nominal voltage U_N	Coil code	Operating range		Resistance R	Rated coil consumption I at U_N (50Hz)
		U_{min}	U_{max}		
V		V	V	Ω	mA
6	8.006	5.1	6.6	4	540
12	8.012	10.2	13.2	14	275
24	8.024	20.4	26.4	62	130
48	8.048	40.8	52.8	220	70
60	8.060	51	66	348	55
110	8.110	93.5	121	1200	30
120	8.120	106	137	1350	24
230	8.230	196	253	5000	14
240	8.240	204	264	6300	12.5
400	8.400	340	440	14700	7.8

Coil specifications

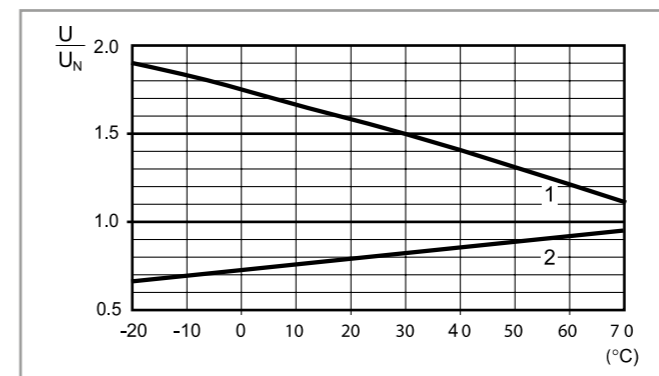
R 62 - DC coil operating range v ambient temperature
Changeover contacts

- 1 - Max. permitted coil voltage.
2 - Min. pick-up voltage with coil at ambient temperature.

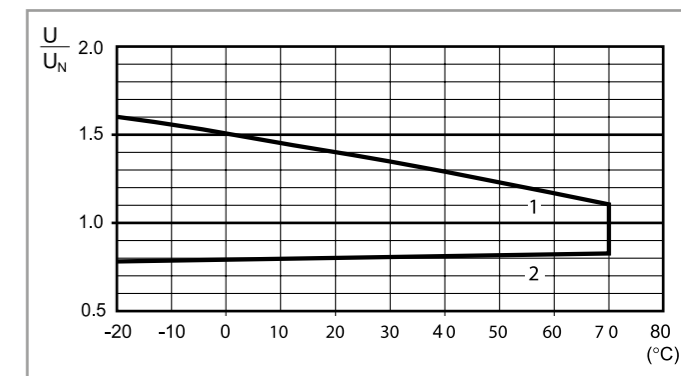
R 62 - AC coil operating range v ambient temperature
Changeover contacts

- 1 - Max. permitted coil voltage.
2 - Min. pick-up voltage with coil at ambient temperature.

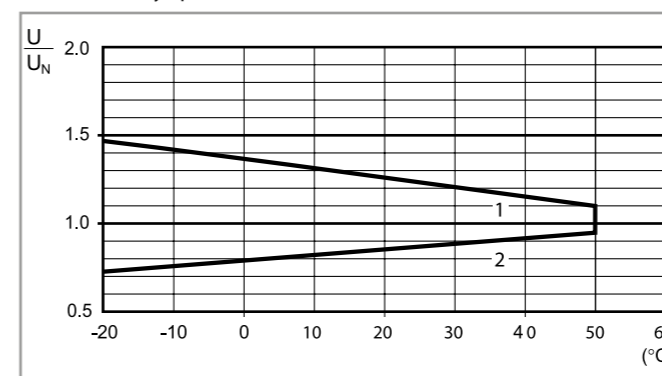
R 62 - DC coil operating range v ambient temperature
Normally open contacts

- 1 - Max. permitted coil voltage.
2 - Min. pick-up voltage with coil at ambient temperature.

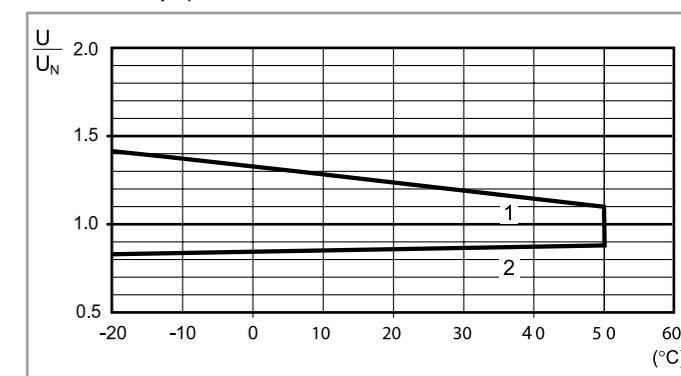
R 62 - AC coil operating range v ambient temperature
Normally open contacts

- 1 - Max. permitted coil voltage.
2 - Min. pick-up voltage with coil at ambient temperature.

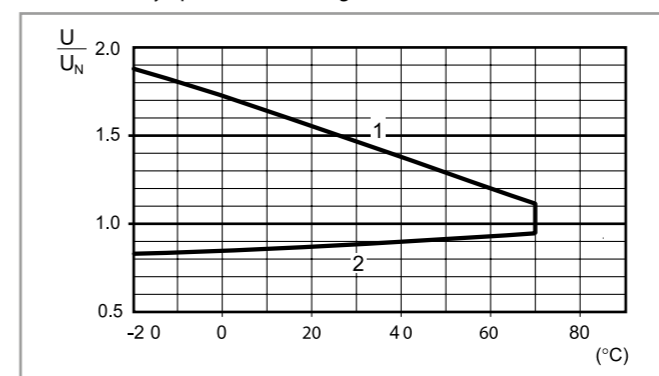
R 62 - DC coil operating range v ambient temperature
Normally open contacts - magnetic blow version

- 1 - Max. permitted coil voltage.
2 - Min. pick-up voltage with coil at ambient temperature.

Outline drawings

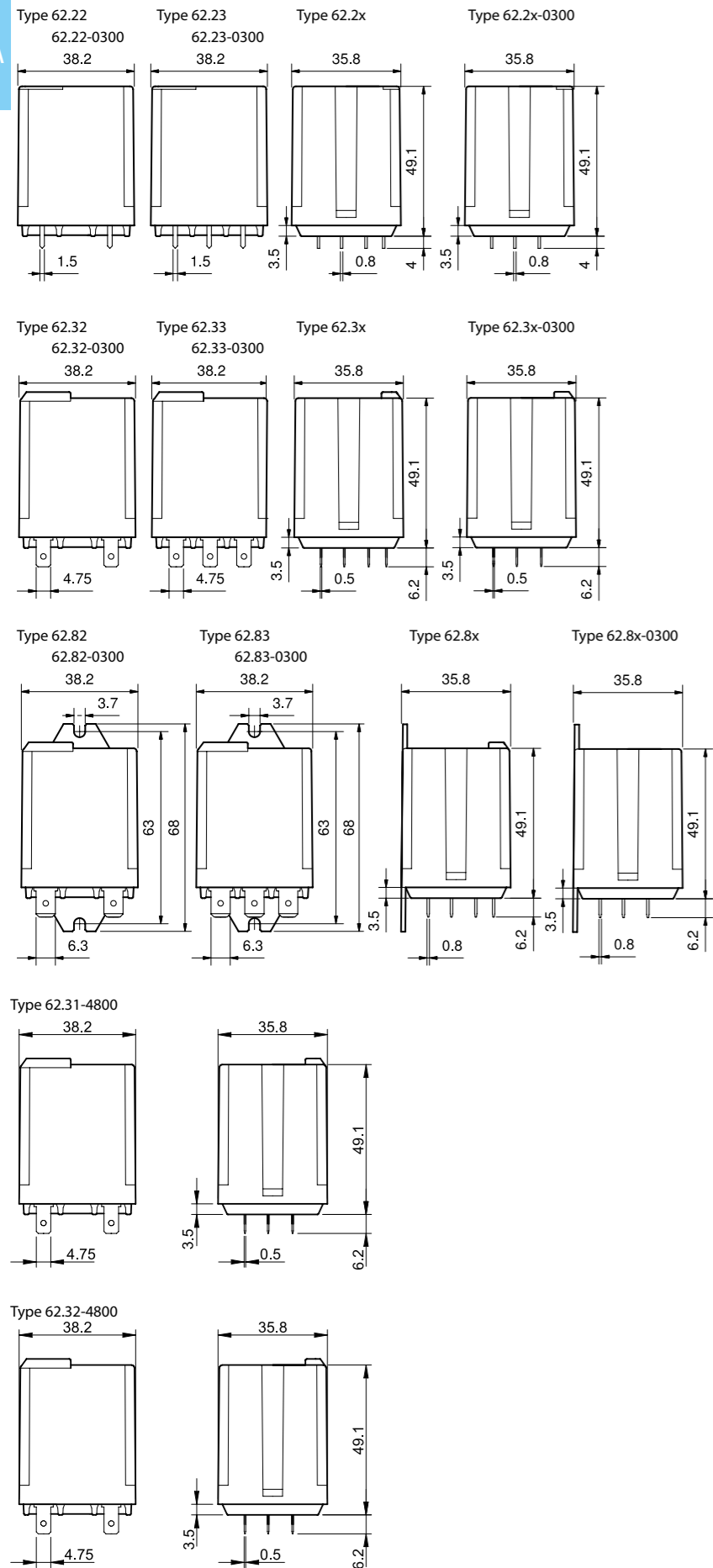

Accessories

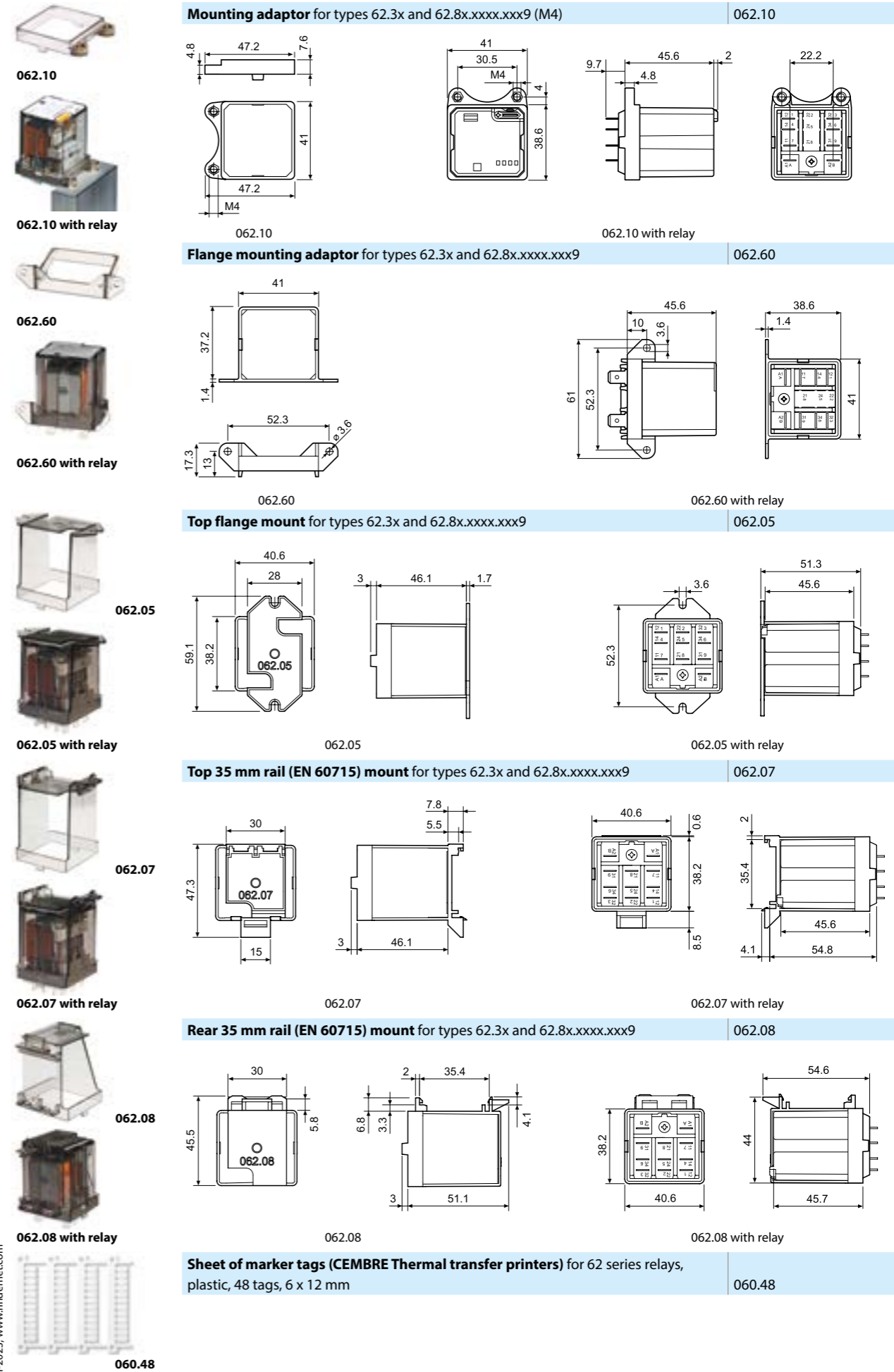

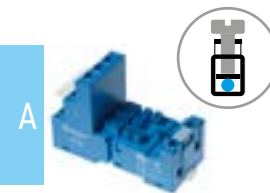

92.03
Approvals
(according to type):
CE UK CA EAC cRU US

Screw terminal (Box clamp) socket panel or 35 mm rail (EN 60715) mount	92.03 Blue	92.03.0 Black
For relay type	62.31, 62.32, 62.33	
Accessories		
Metal retaining clip (supplied with socket - packaging code SMA)	092.71	
Identification tag	092.00.2	
Modules (see table below)	99.02	
Timer modules (see table below)	86.00, 86.30	
Technical data		
Rated values	16 A - 250 V	
Dielectric strength	6 kV (1.2/50 μs) between coil and contacts	
Protection category	IP 20	
Ambient temperature	°C -40...+70 (see diagram L92)	
Screw torque	Nm 0.8	
Wire strip length	mm 10	
Max. wire size for 92.03 socket	solid wire	stranded wire
	mm ² 1 x 10 / 2 x 4	1 x 6 / 2 x 4
	AWG 1 x 8 / 2 x 12	1 x 10 / 2 x 12

L 92 - Rated current v ambient temperature

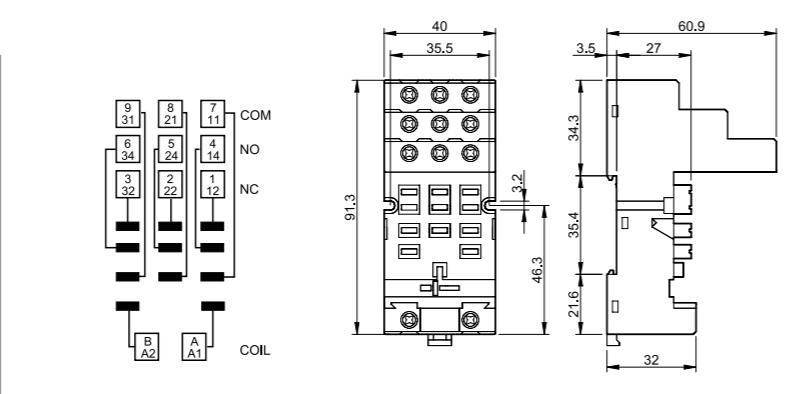
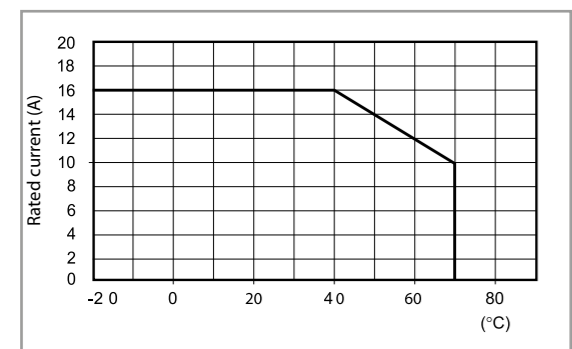

99.02
Approvals
(according to type):
EAC cRU US

DC Modules with
non-standard polarity
(+A2) on request.

86 series timer modules		
Multi-voltage: (12...240)V AC/DC; Multi-functions: AI, DI, SW, BE, CE, DE, EE, FE; (0.05 s...100 h)		86.00.0.240.0000
(12...24)V AC/DC; Bi-function: AI, DI; (0.05 s...100 h)		86.30.0.024.0000
(110...125)V AC; Bi-function: AI, DI; (0.05 s...100 h)		86.30.8.120.0000
(230...240)V AC; Bi-function: AI, DI; (0.05 s...100 h)		86.30.8.240.0000

99.02 coil indication and EMC suppression modules for 92.03 socket		
Diode (+A1, standard polarity)	(6...220)V DC	99.02.3.000.00
LED	(6...24)V DC/AC	99.02.0.024.59
LED	(28...60)V DC/AC	99.02.0.060.59
LED	(110...240)V DC/AC	99.02.0.230.59
LED + Diode (+A1, standard polarity)	(6...24)V DC	99.02.9.024.99
LED + Diode (+A1, standard polarity)	(28...60)V DC	99.02.9.060.99
LED + Diode (+A1, standard polarity)	(110...220)V DC	99.02.9.220.99
LED + Varistor	(6...24)V DC/AC	99.02.0.024.98
LED + Varistor	(28...60)V DC/AC	99.02.0.060.98
LED + Varistor	(110...240)V DC/AC	99.02.0.230.98
RC circuit	(6...24)V DC/AC	99.02.0.024.09
RC circuit	(28...60)V DC/AC	99.02.0.060.09
RC circuit	(110...240)V DC/AC	99.02.0.230.09
Residual current by-pass*	(110...240)V AC	99.02.8.230.07

* Additional 0.9 W power dissipation

I-2023, www.findernet.com



92.13
Approvals
(according to type):
EAC cRU US

PCB socket	92.13 (blue)	92.13.0 (black)
For relay type	62.31, 62.32, 62.33	
Accessories		
Metal retaining clip (supplied with socket - packaging code SMA)	092.54	
Technical data		
Rated values	10 A - 250 V	
Dielectric strength	2.5 kV AC	
Ambient temperature	°C -40...+70	

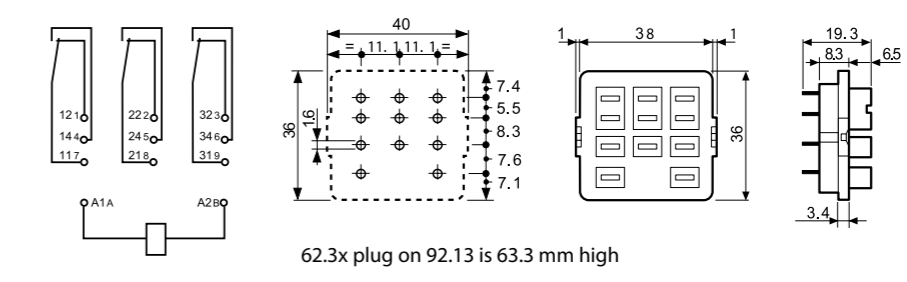

92.33
Approvals
(according to type):
CE UK CA EAC cRU US

Panel mount solder socket mounted with M3 screw	92.33 (blue)
For relay type	62.31, 62.32, 62.33
Accessories	
Metal retaining clip (supplied with socket - packaging code SMA)	092.54
Technical data	
Rated values	10 A - 250 V
Dielectric strength	2.5 kV AC
Ambient temperature	°C -40...+70

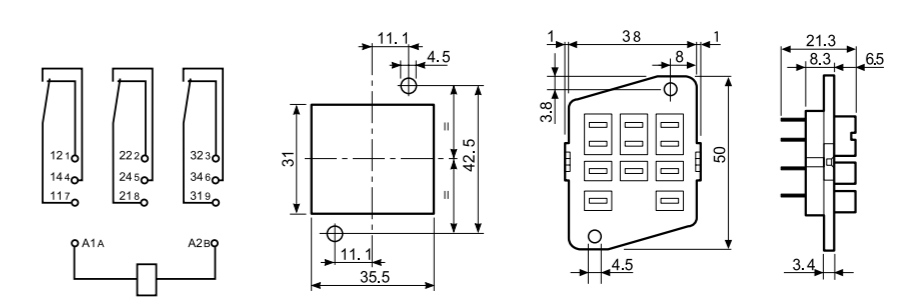

Packaging codes

How to code and identify retaining clip and packaging options for sockets.

Example:

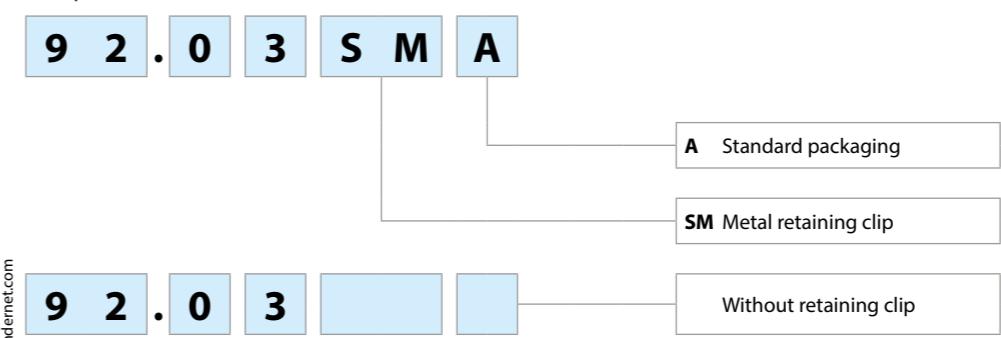

I-2023, www.findernet.com

Please see [general technical information](#)

