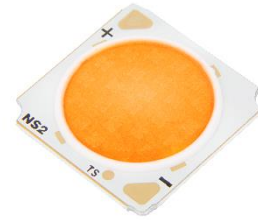


Enable High Flux and Cost Efficient System

### Acrich Chip on Board – MJT COB series

**S4WM-1565xx8036-0C400GxS-00001**

**S4WM-1565xx9036-0C400GxS-00001**



## Product Brief

### Description

- The MJT series are LED arrays which provide High Flux and High Efficacy.
- It is especially designed for easy assembly of Lighting fixtures by eliminating reflow soldering process.
- It's thermal management is excellent than other power LED solutions with wider Metal area.
- The MJT series are ideal light sources for General Lighting applications including Replacement Lamps, Industrial & Commercial Lightings and other high Lumen required applications.

### Features and Benefits

- Efficacy up to 162lm/W @5000K
- Size 19mm \* 19mm
- LES 14.5mm
- MacAdam 2-step & 3-step binning
- Uniformed Shadow
- Excellent Thermal management
- RoHS compliant
- UL recognized component(E359235)

### Key Applications

- Commercial – Downlight
- Replacement lamps – bulb, PAR, MR16
- Industrial
- Residential

**Table 1. Product Selection Table**

Reference Code	Color	Nominal CCT	Part Number	CRI
				Min
SAW81565A	Cool White	6500K	S4WM-1565658036-0C400G3S-00001	80
		5700K	S4WM-1565578036-0C400G3S-00001	
		5000K	S4WM-1565508036-0C400G3S-00001	
	Neutral White	4000K	S4WM-1565408036-0C400G3S-00001	
	Warm White	3500K	S4WM-1565358036-0C400G3S-00001	
		3000K	S4WM-1565308036-0C400G3S-00001	
		2700K	S4WM-1565278036-0C400G3S-00001	
SAW91565A	Neutral White	4000K	S4WM-1565409036-0C400G2S-00001 S4WM-1565409036-0C400G3S-00001	90
		3500K	S4WM-1565359036-0C400G2S-00001 S4WM-1565359036-0C400G3S-00001	
	Warm White	3000K	S4WM-1565309036-0C400G2S-00001 S4WM-1565309036-0C400G3S-00001	
		2700K	S4WM-1565279036-0C400G2S-00001 S4WM-1565279036-0C400G3S-00001	



# Table of Contents

Index	
• Product Brief	1
• Table of Contents	3
• Performance Characteristics	4
• Characteristics Graph	6
• Color Bin Structure	17
• Mechanical Dimensions	19
• Packaging Specification	20
• Product Nomenclature (Labeling Information)	22
• Handling of Silicone Resin for LED	23
• Precaution for Use	24
• Company Information	27

## Performance Characteristics

**Table.2 Electro Optical Characteristics,  $T_j=85^{\circ}\text{C}$** 

Part Number	CCT (K) <sup>[1]</sup>	Typical Luminous Flux <sup>[2]</sup> $\Phi_v$ <sup>[3]</sup> (lm)	Typical Forward Voltage ( $V_f$ ) <sup>[4]</sup>	CRI <sup>[5]</sup> , $R_a$	Viewing Angle (degrees) $2\theta_{1/2}$
	Typ.	0.72A	0.72A	Min.	Typ.
S4WM-1565658036 -0C400Gx <sup>[6]</sup> S-00001	6500	3,865	34.2	80	118
S4WM-1565578036 -0C400Gx <sup>[6]</sup> S-00001	5700	3,905	34.2	80	118
S4WM-1565508036 -0C400Gx <sup>[6]</sup> S-00001	5000	3,950	34.2	80	118
S4WM-1565408036 -0C400Gx <sup>[6]</sup> S-00001	4000	3,925	34.2	80	118
S4WM-1565358036 -0C400Gx <sup>[6]</sup> S-00001	3500	3,845	34.2	80	118
S4WM-1565308036 -0C400Gx <sup>[6]</sup> S-00001	3000	3,790	34.2	80	118
S4WM-1565278036 -0C400Gx <sup>[6]</sup> S-00001	2700	3,655	34.2	80	118
S4WM-1565409036 -0C400Gx <sup>[6]</sup> S-00001	4000	3,295	34.2	90	118
S4WM-1565359036 -0C400Gx <sup>[6]</sup> S-00001	3500	3,230	34.2	90	118
S4WM-1565309036 -0C400Gx <sup>[6]</sup> S-00001	3000	3,185	34.2	90	118
S4WM-1565279036 -0C400Gx <sup>[6]</sup> S-00001	2700	3,050	34.2	90	118

**Notes :**

- (1) Correlated Color Temperature is derived from the CIE 1931 Chromaticity diagram. Color coordinate :  $\pm 0.005$ , CCT  $\pm 5\%$  tolerance.
- (2) Seoul Semiconductor maintains a tolerance of  $\pm 7\%$  on flux and power measurements.
- (3)  $\Phi_v$  is the total luminous flux output as measured with an integrating sphere.
- (4) Tolerance is  $\pm 3\%$  on forward voltage measurements.
- (5) Tolerance is  $\pm 2$  on CRI measurements.
- (6) X is indicate the Ellipse bin size.

\* For reference only.

## Performance Characteristics

**Table.3 Absolute Maximum Ratings**

Parameter	Symbol	Value			Unit
		Min.	Typ.	Max.	
Forward Current	$I_F$	-	0.72	1.8	A
Power Dissipation	$P_d$	-	24.6	67.4	W
Junction Temperature	$T_j$	-	-	150	°C
Operating Temperature	$T_{opr}$	-40	-	100	°C
Surface Temperature	$T_s$	-40	-	120	°C
Storage Temperature	$T_{stg}$	-40	-	105	°C
Thermal resistance (J to S) <sup>[1]</sup>	$R\theta_{J-S}$	-	0.47	-	K/W
ESD Sensitivity(HBM)		Class 3A JESD22-A114-E			

**Notes :**

- (1) Thermal resistance :  $R\theta_{J-S}$  At thermal resistance, J to S means junction to COB's substrate bottom.
- (2) LED's properties might be different from suggested values like above and below tables if operation condition will be exceeded our parameter range. Care is to be taken that power dissipation does not exceed the absolute maximum rating of the product.
- (3) Thermal resistance can be increased substantially depending on the heat sink design/operating condition, and the maximum possible driving current will decrease accordingly.
- (4) All measurements were made under the standardized environment of Seoul Semiconductor.

## Performance Characteristics

Fig 1. Color Spectrum, CRI80

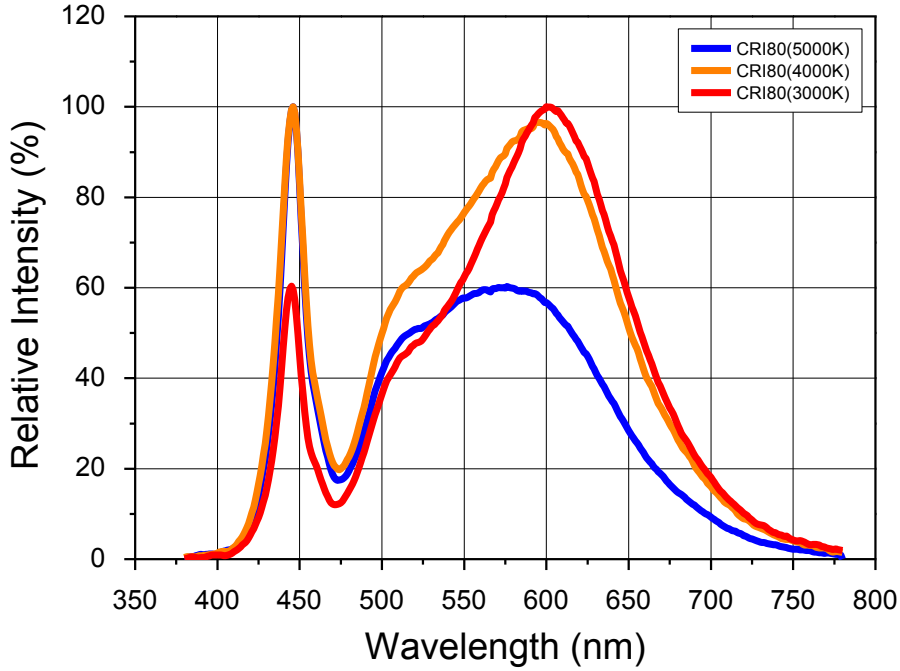
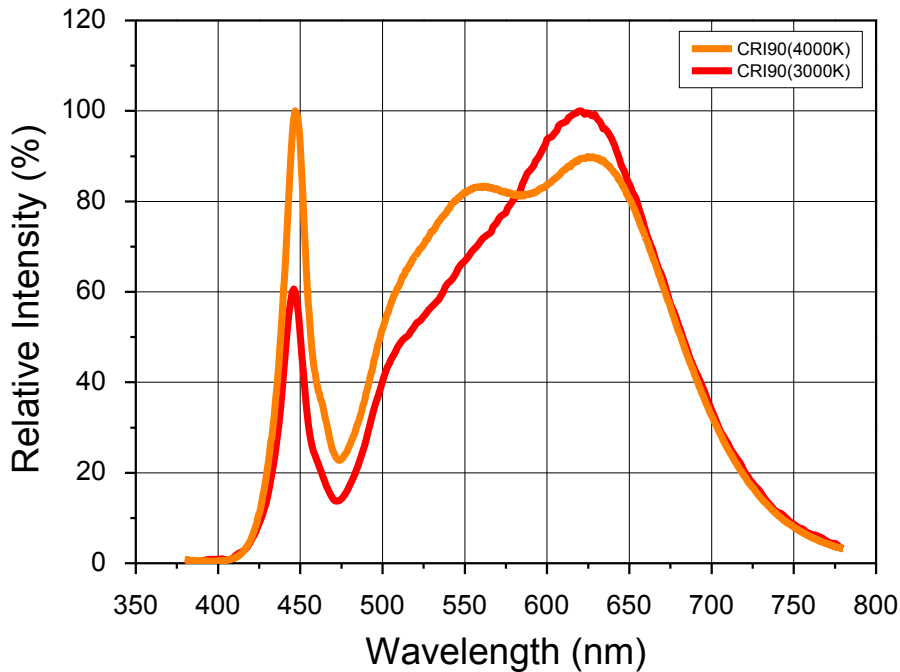
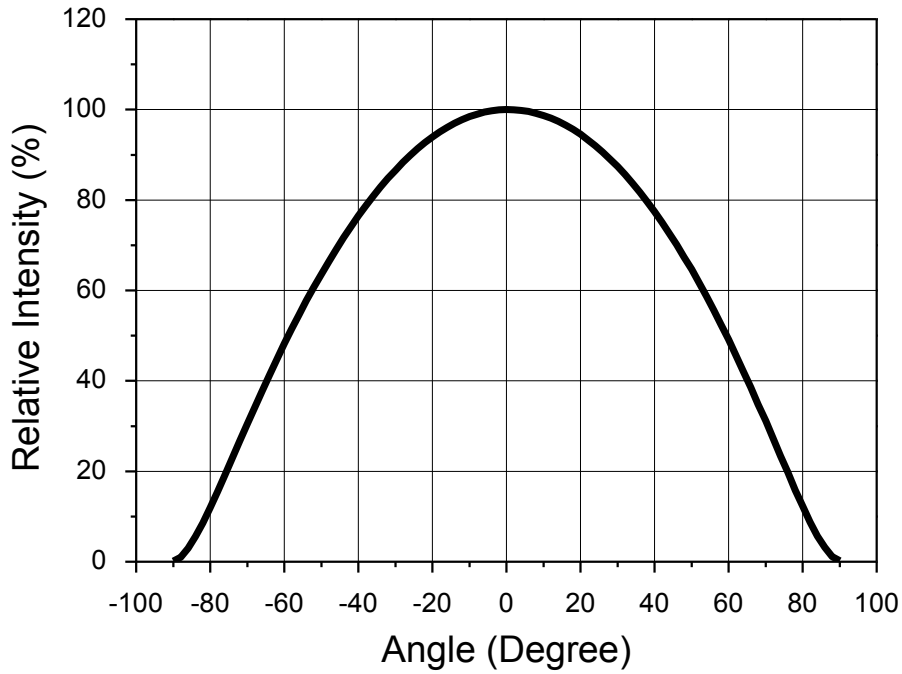


Fig 2. Color Spectrum, CRI90



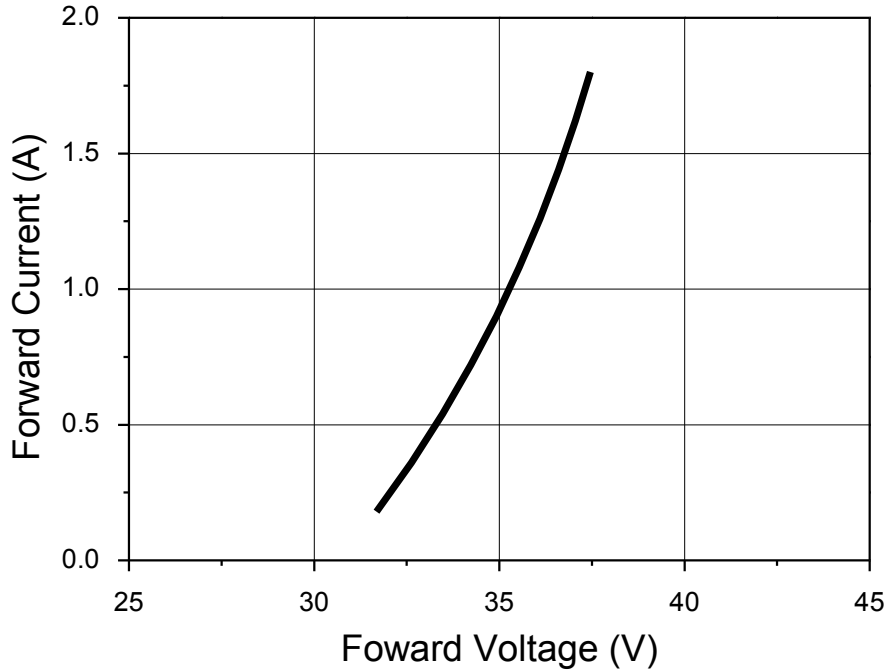
## Performance Characteristics

Fig 3. Radiant Pattern

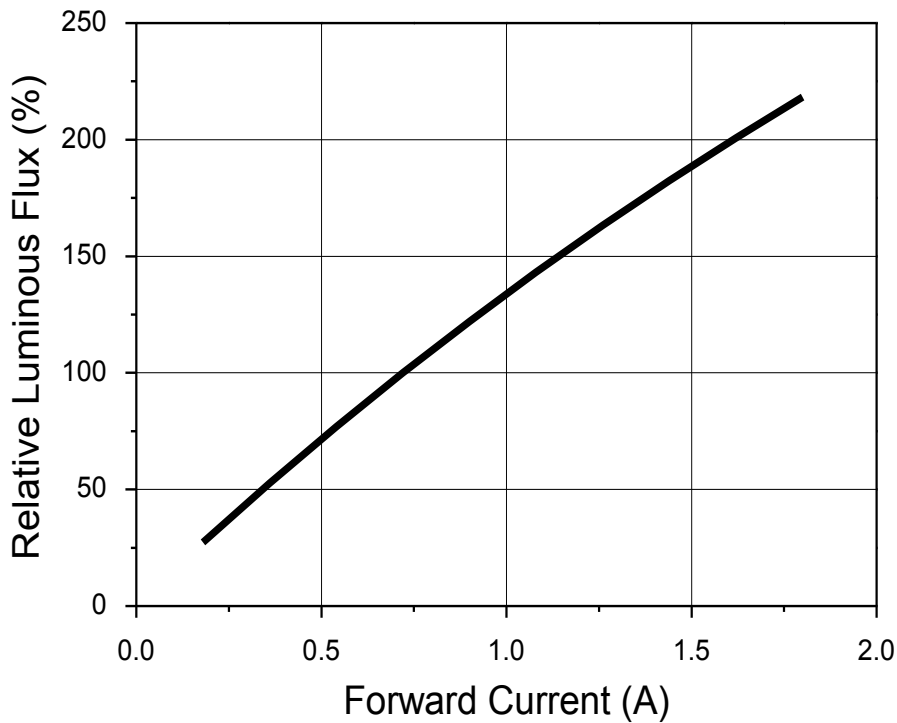


## Performance Characteristics

**Fig 4. Forward Voltage vs. Forward Current,  $T_j=85^\circ\text{C}$**

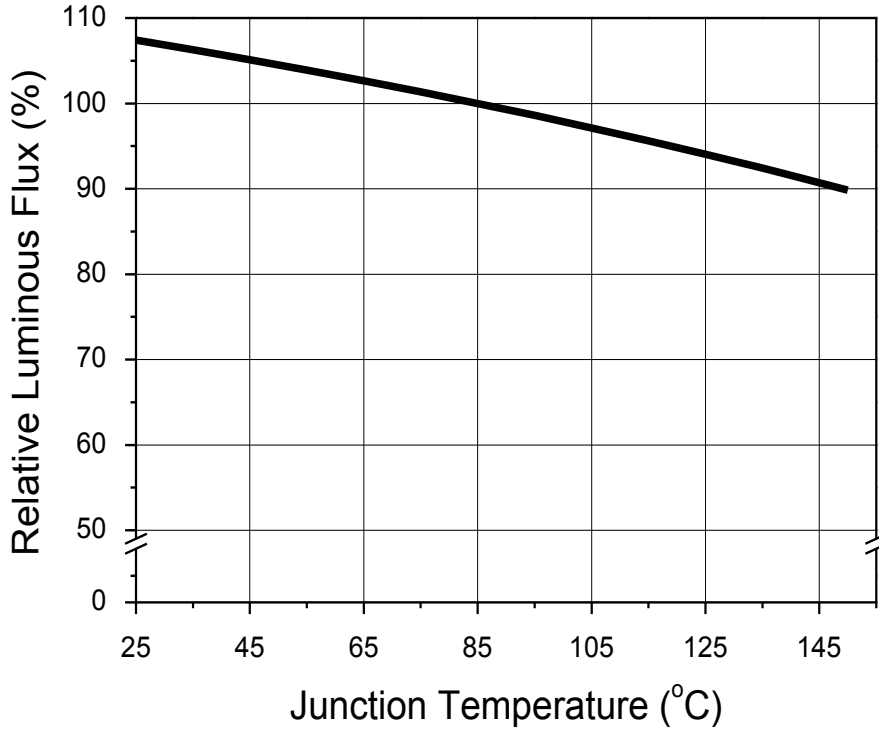
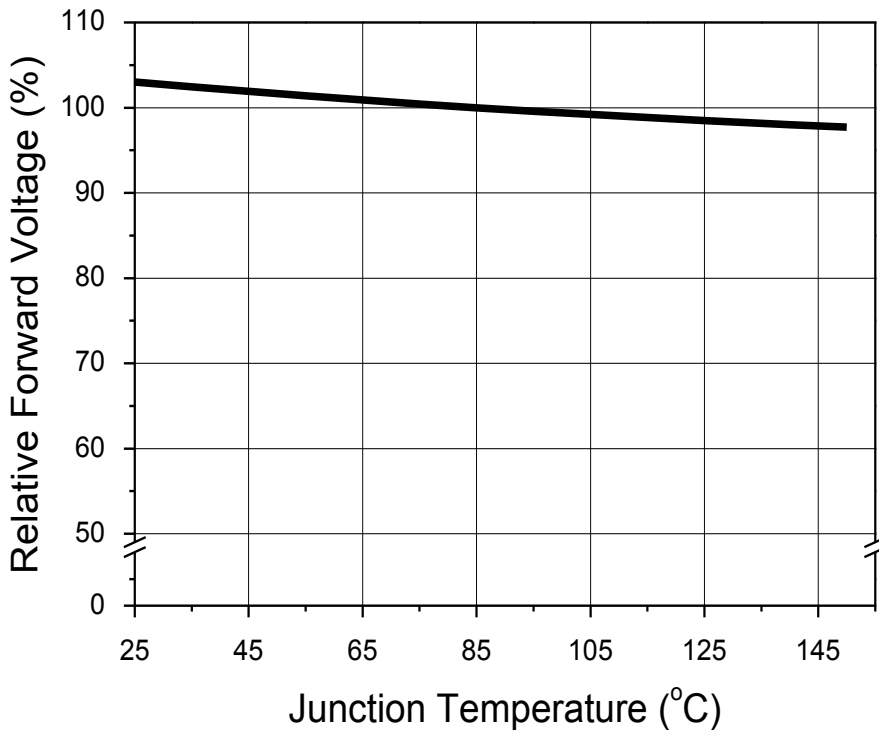


**Fig 5. Forward Current vs. Relative Luminous Flux,  $T_j=85^\circ\text{C}$**





## Performance Characteristics

**Fig 6. Junction Temperature vs. Relative Luminous Flux,  $I_F=0.72A$** 

**Fig 7. Junction Temperature vs. Forward Voltage,  $I_F=0.72A$** 


## Performance Characteristics

Fig 8. Junction Temperature vs. CIE x,y Shift,  $I_f=0.72A$  (CRI80, 5000K)

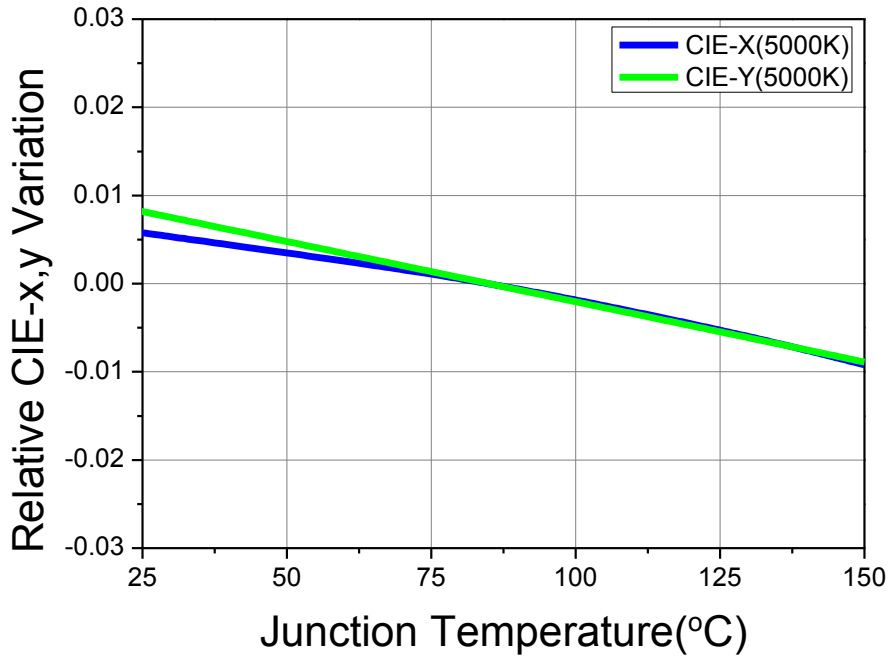
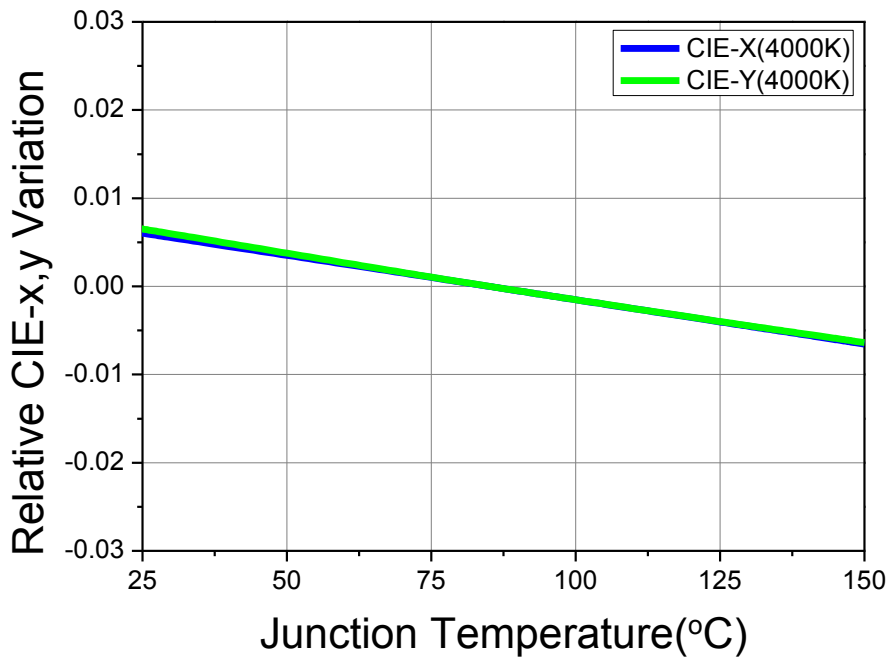
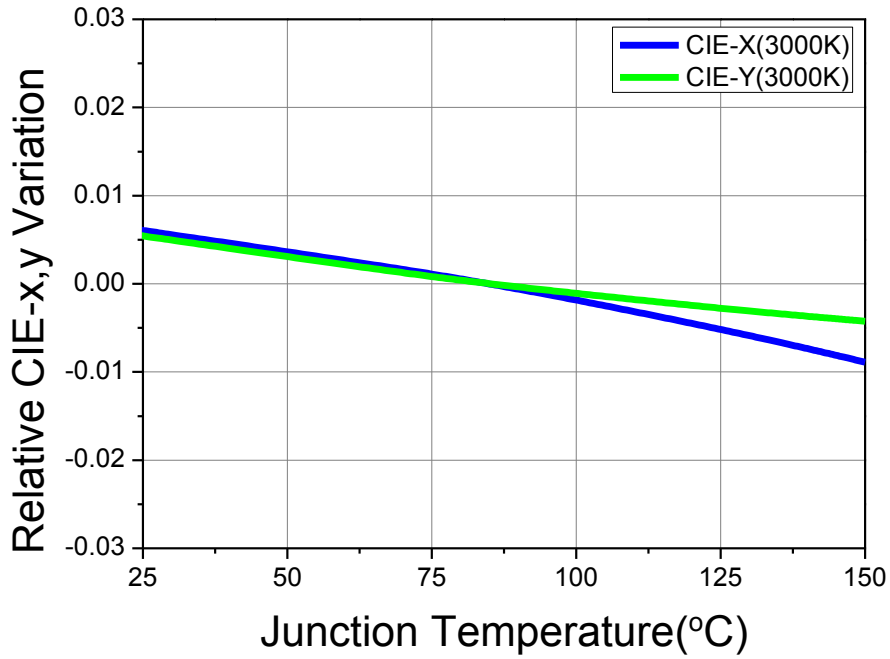


Fig 9. Junction Temperature vs. CIE x,y Shift,  $I_f=0.72A$  (CRI80, 4000K)

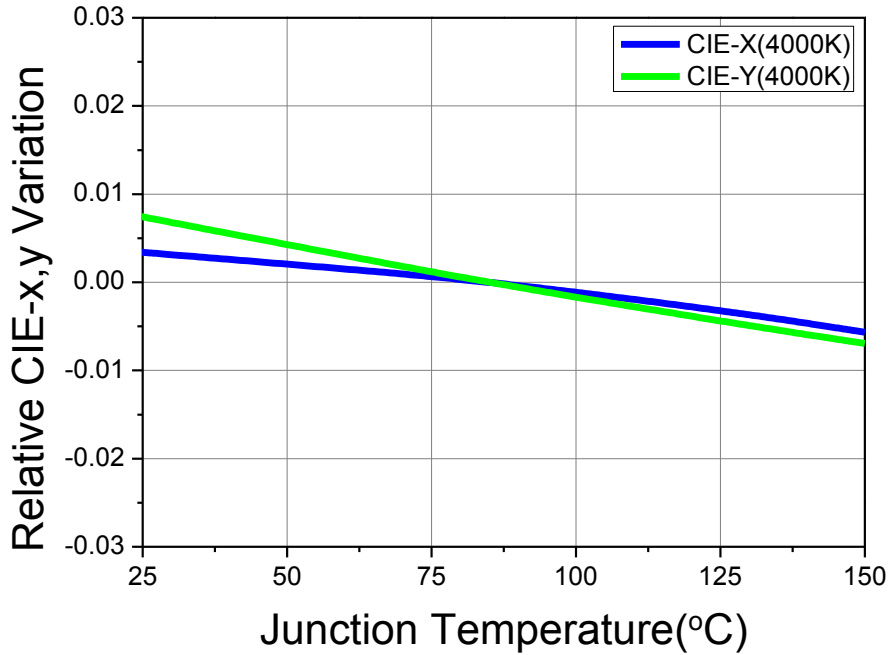
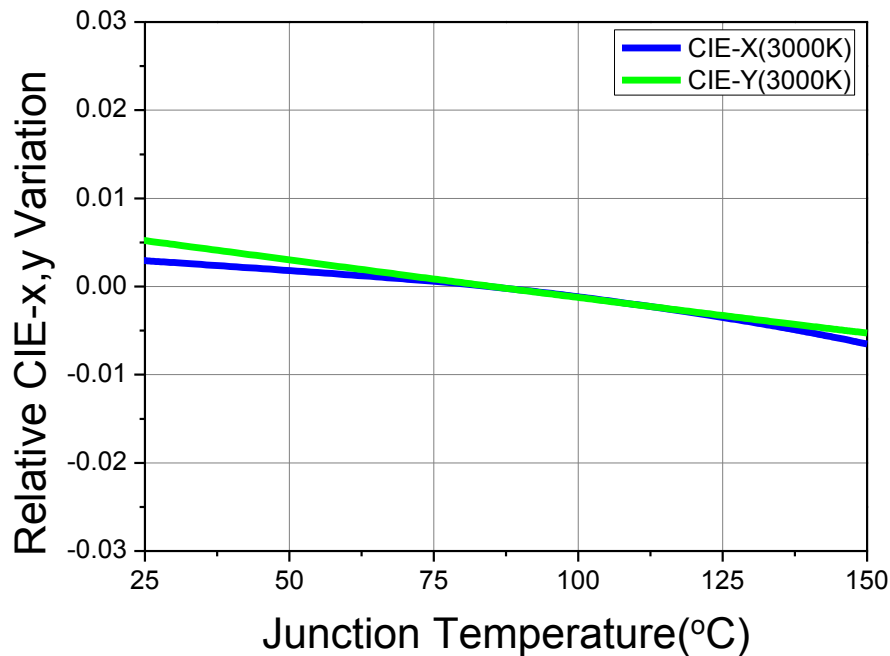


## Performance Characteristics

**Fig 10. Junction Temperature vs. CIE x,y Shift,  $I_f=0.72A$  (CRI80, 3000K)**



## Performance Characteristics

**Fig 11. Junction Temperature vs. CIE x,y Shift,  $I_f=0.72A$  (CRI90, 4000K)**

**Fig 12. Junction Temperature vs. CIE x,y Shift,  $I_f=0.72A$  (CRI90, 3000K)**


## Performance Characteristics

Fig 13. Forward Current vs. CIE x,y Shift,  $T_j=85^\circ\text{C}$  (CRI80, 5000K)

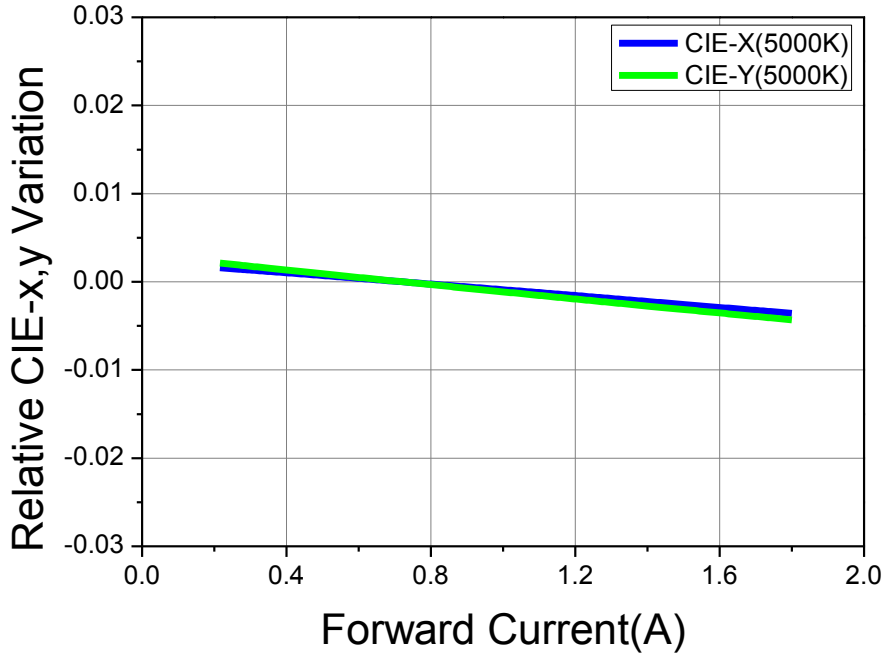
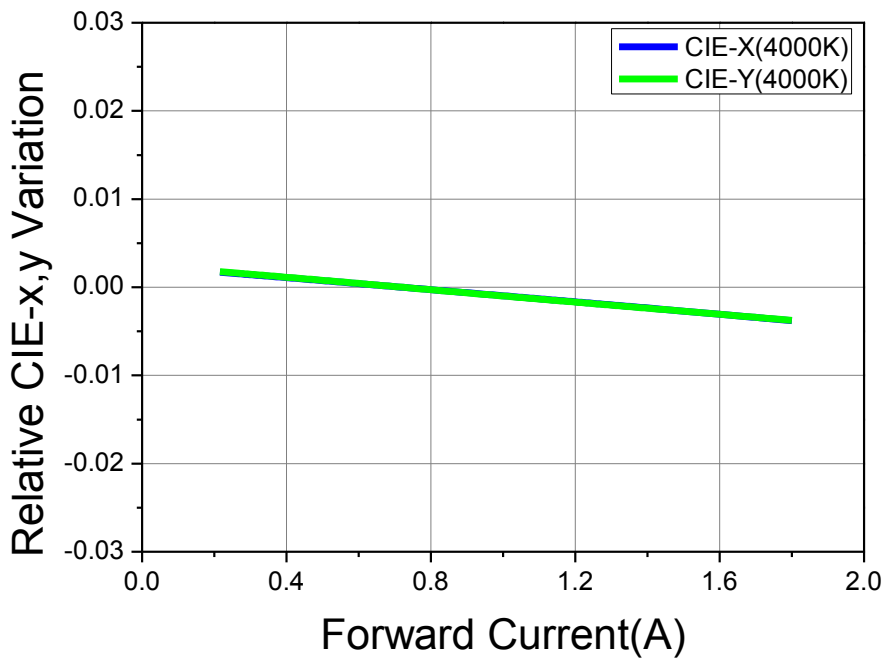
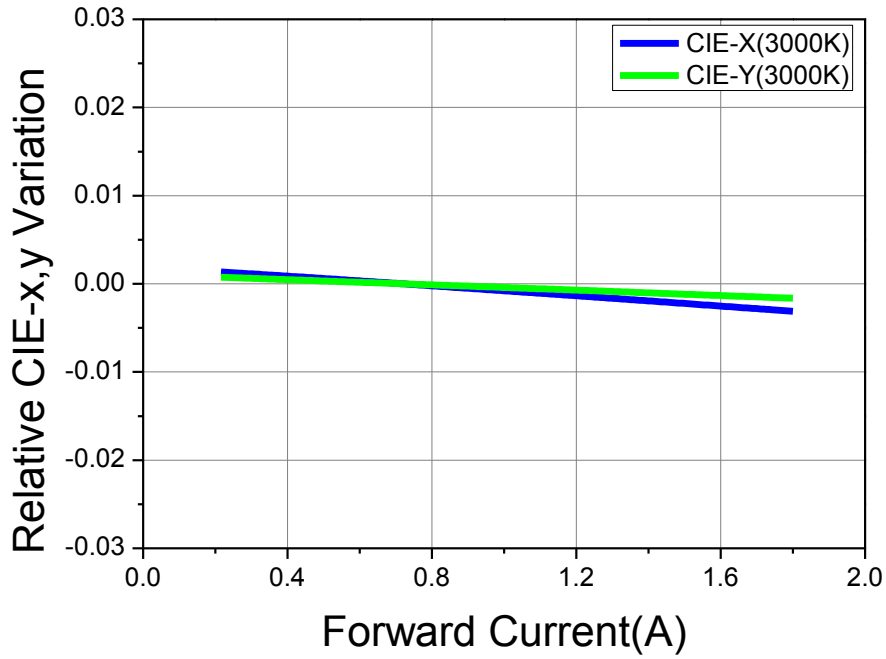


Fig 14. Forward Current vs. CIE x,y Shift,  $T_j=85^\circ\text{C}$  (CRI80, 4000K)



## Performance Characteristics

Fig 15. Forward Current vs. CIE x,y Shift,  $T_j=85^{\circ}\text{C}$  (CRI80, 3000K)



## Performance Characteristics

Fig 16. Forward Current vs. CIE x,y Shift,  $T_j=85^\circ\text{C}$  (CRI90, 4000K)

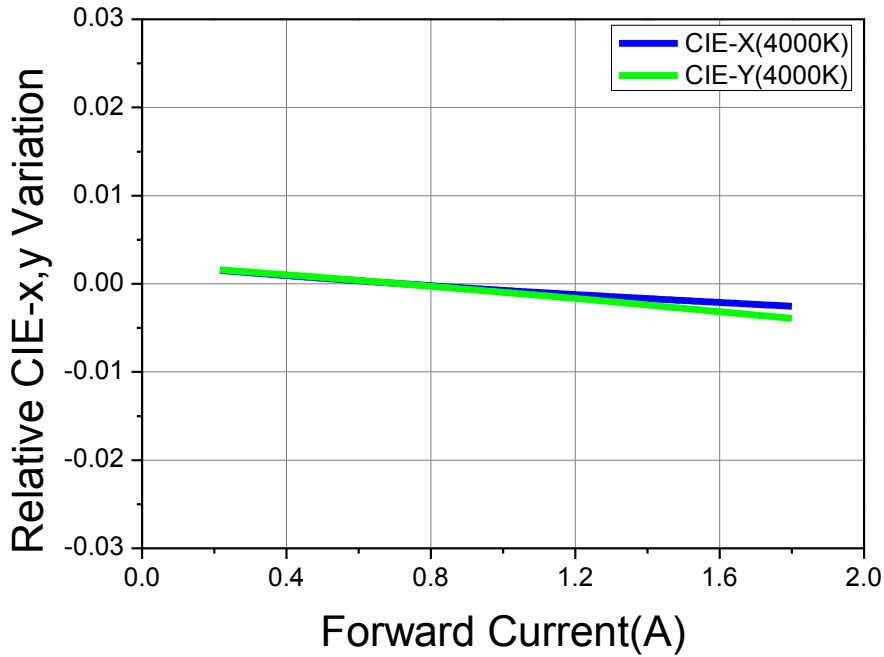
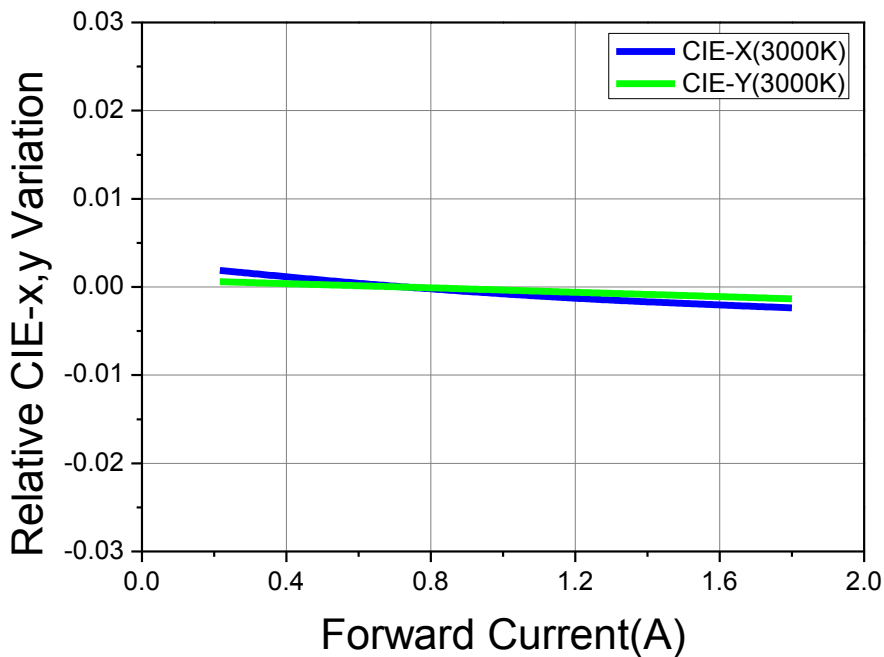
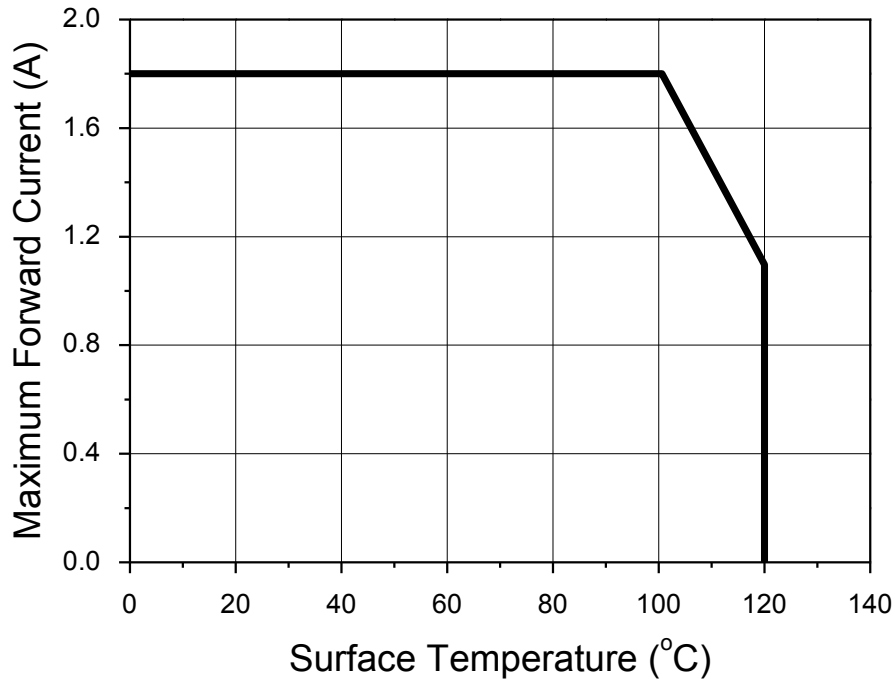


Fig 17. Forward Current vs. CIE x,y Shift,  $T_j=85^\circ\text{C}$  (CRI90, 3000K)



## Performance Characteristics

Fig 18. Surface Temperature vs. Maximum Forward Current,  $T_j(\text{max.})=150^\circ\text{C}$





## Color Bin Structure

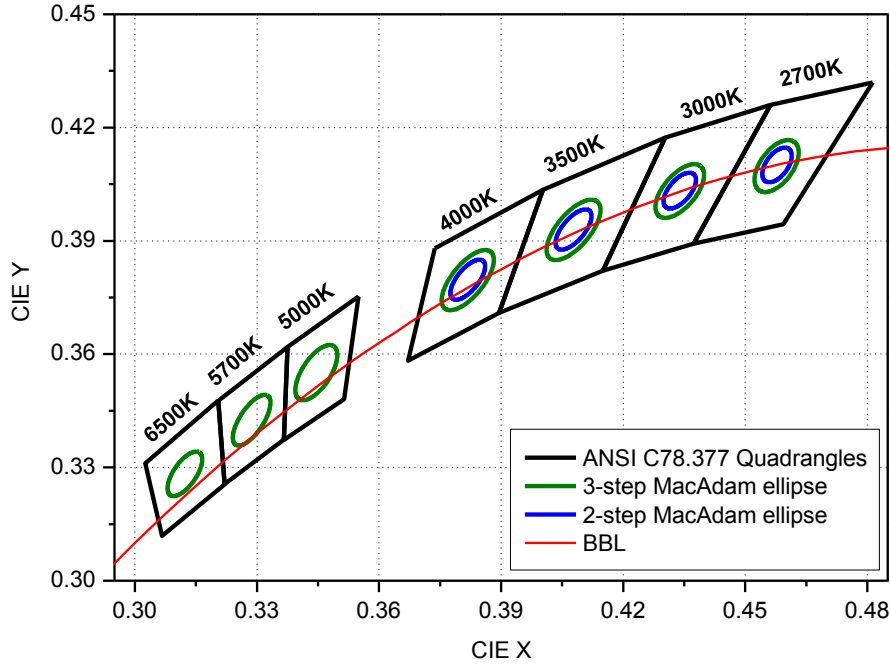
**Table 4. Bin Code Description,  $T_J=85^{\circ}\text{C}$ ,  $I_F=0.72\text{A}$** 

Part Number	Luminous Flux (lm)			Color Chromaticity		Typical Forward Voltage (V)			CRI	
	Bin Code	Min.	Typ.	Bin Code	Typ. CCT	Bin Code	Min.	Max.	Bin Code	Min
S4WM-1565xx <sup>[1]</sup> 8036-0C400Gxx <sup>[2]</sup> -00001	C4	3,555	3,865	AE3	6500K	G	32.5	36.0	8	80
	C4	3,590	3,905	BE3	5700K	G	32.5	36.0	8	80
	C4	3,635	3,950	CE3	5000K	G	32.5	36.0	8	80
	C4	3,610	3,925	EE3	4000K	G	32.5	36.0	8	80
	C4	3,535	3,845	FE3	3500K	G	32.5	36.0	8	80
	C4	3,485	3,790	GE3	3000K	G	32.5	36.0	8	80
	C4	3,360	3,655	HE3	2700K	G	32.5	36.0	8	80
S4WM-1565xx <sup>[1]</sup> 9036-0C400Gxx <sup>[2]</sup> -00001	C4	3,030	3,295	EE2 EE3	4000K	G	32.5	36.0	9	90
	C4	2,970	3,230	FE2 FE3	3500K	G	32.5	36.0	9	90
	C4	2,930	3,185	GE2 GE3	3000K	G	32.5	36.0	9	90
	C4	2,805	3,050	HE2 HE3	2700K	G	32.5	36.0	9	90

**Notes :**

(1) [1] and [2] indicate the CCT and the Ellipse bin size, respectively.

## Color Bin Structure

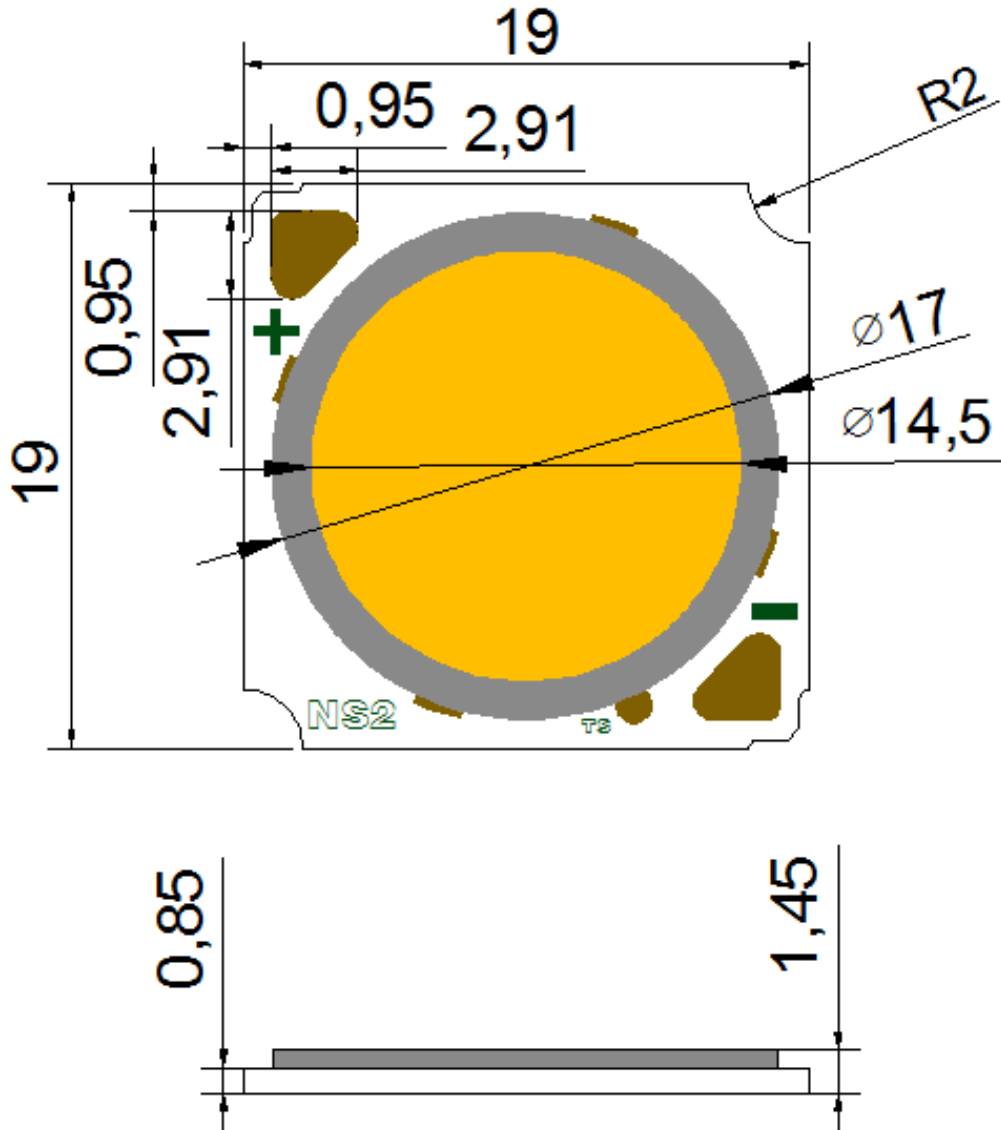
**CIE Chromaticity Diagram,  $T_j=85^\circ\text{C}$** 

**Table 5. 3-step/2-step MacAdam Ellipse Color Bin Definitions**

Color Region	CCT (K)	Center Point		Major Axis (a)	Minor Axis (b)	Rotation Angle ( $\theta$ )
		CIE x	CIE y			
3-step MacAdam Ellipse	6500	0.3123	0.3283	0.00669	0.00285	58.38
	5700	0.3287	0.3425	0.00760	0.00296	59.46
	5000	0.3446	0.3551	0.00822	0.00354	59.62
	4000	0.3818	0.3797	0.00939	0.00402	54.00
	3500	0.4078	0.3930	0.00951	0.00417	52.97
	3000	0.4339	0.4033	0.00834	0.00408	53.17
	2700	0.4578	0.4101	0.00774	0.00411	57.28
Color Region	CCT (K)	Center Point		Major Axis (a)	Minor Axis (b)	Rotation Angle ( $\theta$ )
		CIE x	CIE y			
2-step MacAdam Ellipse	4000	0.3818	0.3797	0.00626	0.00268	54.00
	3500	0.4078	0.3930	0.00634	0.00278	52.97
	3000	0.4339	0.4033	0.00556	0.00272	53.17
	2700	0.4578	0.4101	0.00516	0.00274	57.28

**Notes :**

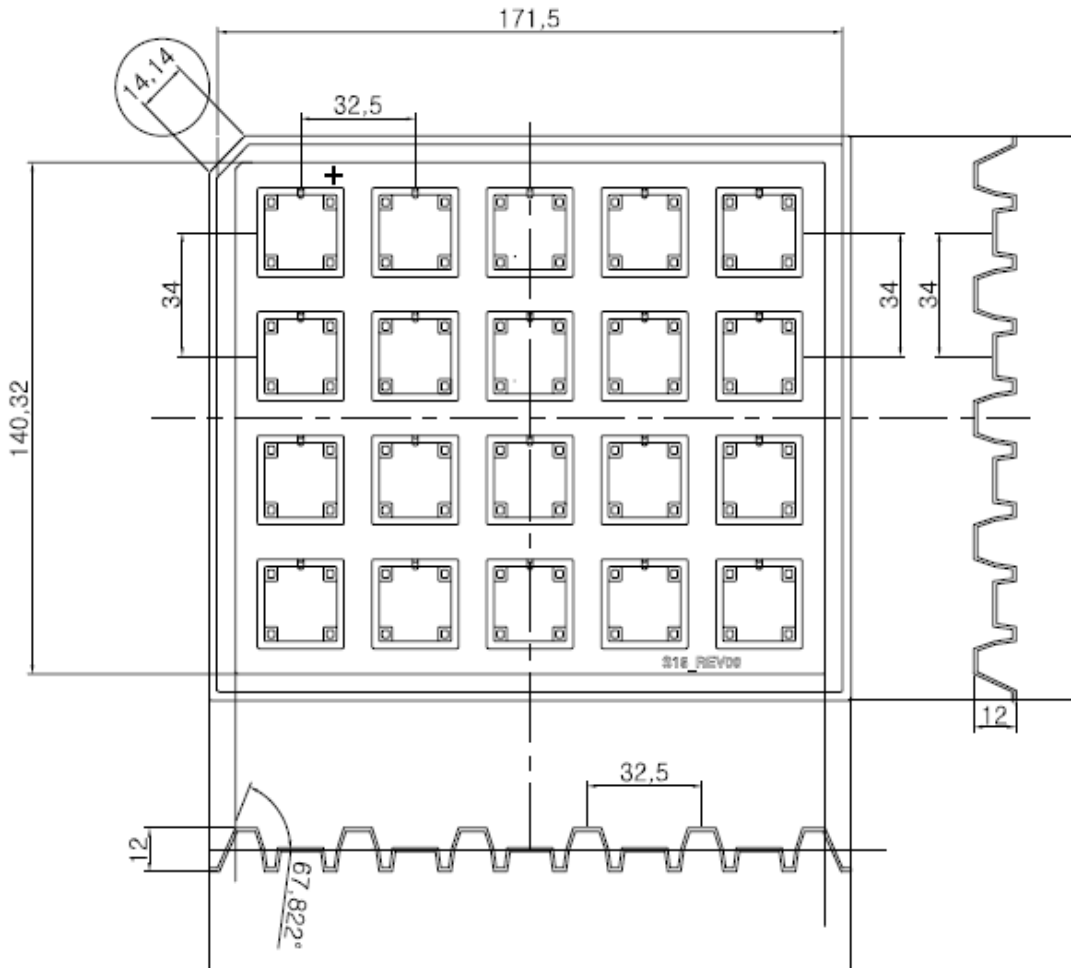
- (1) The chromaticity center refers to ANSI C78.377:2015.
- (2) (a), (b), and ( $\theta$ ) indicate the major axis length, the minor axis length, and the rotation angle from the X axis of the ellipse bin, respectively.

## Mechanical Dimensions


**Notes :**

- (1) All dimensions are in millimeters.
- (2) Not to scale
- (3) Undefined tolerance is  $\pm 0.2$ mm

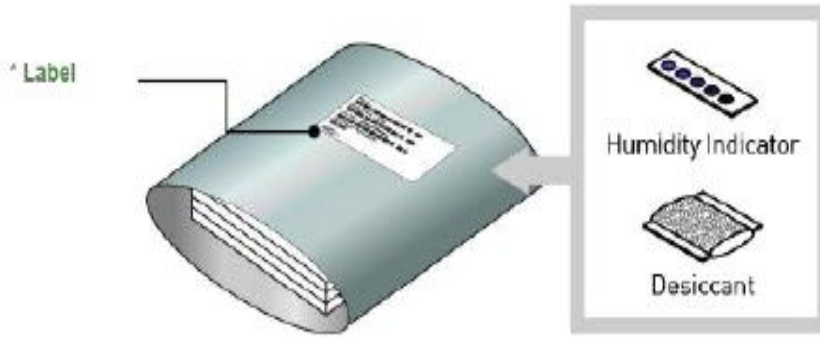
# Packaging Specification


**Notes :**

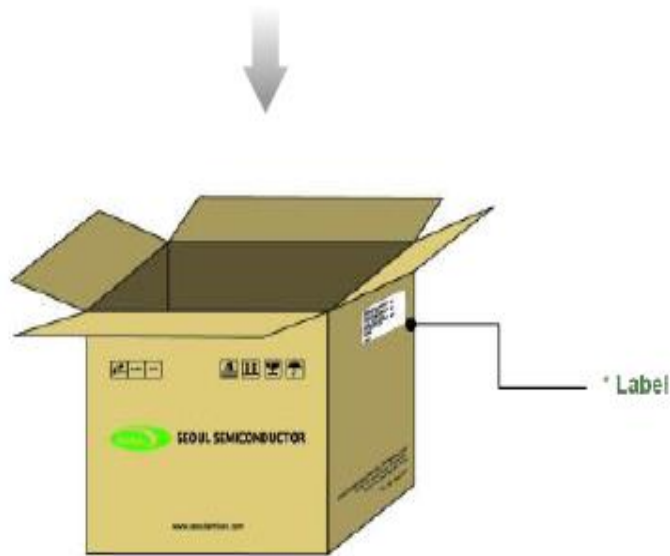
- (1) Quantity : 20pcs/Tray
- (2) All dimensions are in millimeters (tolerance :  $\pm 0.3$ )
- (3) Not to scale

## Packaging Specification

### Aluminum Bag



### Outer Box



**Notes :**

- (1) Heat sealed after packing (Use Zipper Bag)
- (2) Quantity : 1Tray(20pcs) /Bag
- (3) Smallest packing quantity : 3Bags(60pcs) / small box

## Product Nomenclature

**Table 5. Part Numbering System**

Part Number Code	Description	Part Number	Value
X <sub>1</sub>	Company	S	Seoul Semiconductor
X <sub>2</sub>	Level of Integration	4	COB
X <sub>3</sub> X <sub>4</sub>	Technology	WM	MJT White
X <sub>5</sub> X <sub>6</sub> X <sub>7</sub> X <sub>8</sub>	LES + Series and Parallel	1565	
X <sub>9</sub> X <sub>10</sub>	CCT	xx	
X <sub>11</sub> X <sub>12</sub>	CRI	xx	
X <sub>13</sub> X <sub>14</sub>	Vf	36	
X <sub>15</sub> X <sub>16</sub> X <sub>17</sub>	Characteristic code Flux Rank	0C4	
X <sub>18</sub> X <sub>19</sub> X <sub>20</sub>	Characteristic code Vf Rank	00G	
X <sub>21</sub> X <sub>22</sub>	Characteristic code Color Step	xS	3S = 3step ellipse 2S = 2step ellipse
X <sub>23</sub> X <sub>24</sub>	Type	00	
X <sub>25</sub> X <sub>26</sub> X <sub>27</sub>	Internal code	001	

## Handling of Silicone Resin for LED

- (1) During processing, mechanical stress on the surface should be minimized as much as possible. Sharp objects of all types should not be used to pierce the sealing compound.



- (2) In general, LED should only be handled from the side. By the way, this also applies to LED without a silicone sealant, since the surface can also become scratched.



- (3) Silicone differs from materials conventionally used for the manufacturing of LED. These conditions must be considered during the handling of such devices. Compared to standard encapsulants, silicone is generally softer, and the surface is more likely to attract dust. As mentioned previously, the increased sensitivity to dust requires special care during processing. In cases where a minimal level of dirt and dust particles cannot be guaranteed, a suitable cleaning solution must be applied to the surface after the soldering of wire.
- (4) Seoul Semiconductor suggests using isopropyl alcohol for cleaning. In case other solvents are used, it must be assured that these solvents do not dissolve the package or resin. Ultrasonic cleaning is not recommended. Ultrasonic cleaning may cause damage to the LED.
- (5) Please do not mold this product into another resin (epoxy, urethane, etc) and do not handle this product with acid or sulfur material in sealed space.
- (6) Avoid leaving fingerprints on silicone resin parts.

## Precaution for Use

### (1) Storage

To avoid the moisture penetration, we recommend storing LED in a dry box with a desiccant . The recommended storage temperature range is 5°C to 30°C and a maximum humidity of RH50%.

### (2) Use precaution after opening the packaging

Use SMT techniques properly when you solder the LED as separation of the lens may affect the light output efficiency.

Pay attention to the following:

a. Recommend conditions after opening the package

- Sealing / Temperature : 5 ~ 30°C Humidity : less than RH60%

b. If the package has been opened more than 4 week(MSL\_2a) or the color of the desiccant damage, components should be dried for 10-24hr at 65±5°C

### (3) Radioactive exposure is not considered for the products listed here.

(4) Gallium arsenide is used in some of the products listed this publication. These products are dangerous if they are burned or shredded in the process of disposal. It is also dangerous to drink the liquid or inhale the gas generated by such products when chemically disposed.

(5) This device should not be used in any type of fluid such as water, oil, organic solvent and etc. When washing is required, IPA (Isopropyl Alcohol) should be used.

(6) When the LED are in operation the maximum current should be decided after measuring the package temperature.

(7) LED must be stored in a clean environment. We recommend LED store in nitrogen-filled container.

(8) The appearance and specifications of the product may be modified for improvement without notice.

(9) Long time exposure of sunlight or occasional UV exposure will cause lens discoloration.

(10) Attaching LED, do not use adhesive that outgas organic vapor.

(11) The driving circuit must be designed to allow forward voltage only when it is ON or OFF. If the reverse voltage is applied to LED, migration can be generated resulting in LED damage.

(12) Please do not touch any of the circuit board, components or terminals with bare hands or metal while circuit is electrically active.



## Precaution for Use

(13) VOCs (Volatile organic compounds) emitted from materials used in the construction of fixtures can penetrate silicone encapsulants of LED and discolor when exposed to heat and photonic energy. The result can be a significant loss of light output from the fixture. Knowledge of the properties of the materials selected to be used in the construction of fixtures can help prevent these issues.

(14) LED are sensitive to Electro-Static Discharge (ESD) and Electrical Over Stress (EOS). Below is a list of suggestions that Seoul Semiconductor purposes to minimize these effects.

### a. ESD (Electro Static Discharge)

Electrostatic discharge (ESD) is defined as the release of static electricity when two objects come into contact. While most ESD events are considered harmless, it can be an expensive problem in many industrial environments during production and storage. The damage from ESD to LED may cause the product to demonstrate unusual characteristics such as:

- Increase in reverse leakage current lowered turn-on voltage
- Abnormal emissions from the LED at low current

The following recommendations are suggested to help minimize the potential for an ESD event.

One or more recommended work area suggestions:

- Ionizing fan setup
- ESD table/shelf mat made of conductive materials
- ESD safe storage containers

One or more personnel suggestion options:

- Antistatic wrist-strap
- Antistatic material shoes
- Antistatic clothes

Environmental controls:

- Humidity control (ESD gets worse in a dry environment)

## Precaution for Use

### b. EOS (Electrical Over Stress)

Electrical Over-Stress (EOS) is defined as damage that may occur when an electronic device is subjected to a current or voltage that is beyond the maximum specification limits of the device. The effects from an EOS event can be noticed through product performance like:

- Changes to the performance of the LED package  
(If the damage is around the bond pad area and since the package is completely encapsulated the package may turn on but flicker show severe performance degradation.)
- Changes to the light output of the luminaire from component failure
- Components on the board not operating at determined drive power

Failure of performance from entire fixture due to changes in circuit voltage and current across total circuit causing trickle down failures. It is impossible to predict the failure mode of every LED exposed to electrical overstress as the failure modes have been investigated to vary, but there are some common signs that will indicate an EOS event has occurred:

- Damage may be noticed to the bond wires (appearing similar to a blown fuse)
- Damage to the bond pads located on the emission surface of the LED package  
(shadowing can be noticed around the bond pads while viewing through a microscope)
- Anomalies noticed in the encapsulation and phosphor around the bond wires.
- This damage usually appears due to the thermal stress produced during the EOS event.

### c. To help minimize the damage from an EOS event Seoul Semiconductor recommends utilizing:

- A surge protection circuit
- An appropriately rated over voltage protection device
- A current limiting device



## **Company Information**

### **Published by**

Seoul Semiconductor © 2013 All Rights Reserved.

### **Company Information**

Seoul Semiconductor ([www.SeoulSemicon.com](http://www.SeoulSemicon.com)) manufactures and packages a wide selection of light emitting diodes (LED) for the automotive, general illumination/lighting, Home appliance, signage and back lighting markets. The company is the world's fifth largest LED supplier, holding more than 10,000 patents globally, while offering a wide range of LED technology and production capacity in areas such as "nPola", "Acrich", the world's first commercially produced AC LED, and "Acrich MJT - Multi-Junction Technology" a proprietary family of high-voltage LED.

The company's broad product portfolio includes a wide array of package and device choices such as Acrich and Acirch2, high-brightness LED, mid-power LED, side-view LED, and through-hole type LED as well as custom modules, displays, and sensors.

### **Legal Disclaimer**

Information in this document is provided in connection with Seoul Semiconductor products. With respect to any examples or hints given herein, any typical values stated herein and/or any information regarding the application of the device, Seoul Semiconductor hereby disclaims any and all warranties and liabilities of any kind, including without limitation, warranties of non-infringement of intellectual property rights of any third party. The appearance and specifications of the product can be changed to improve the quality and/or performance without notice.