

### General information

Part number	S21KAC-P05MJG0-250S
Termination	solder
Size	1
Locking principle	push
Coding	a_key
Cable Diameter	cable_mini_25
Cable outlet	bend_relief

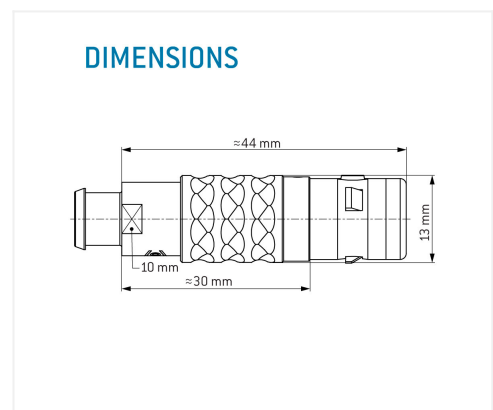
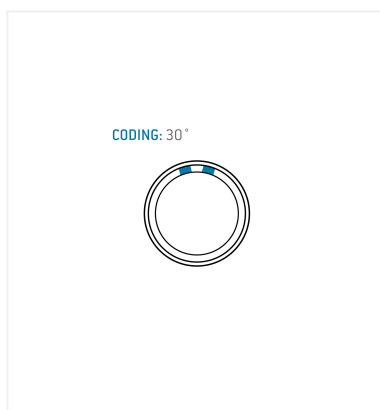

### Contact insert description

Number of contacts	5
Contact type	pins
Contact diameter	09mm
Insulator material	peek
Wire cross section	22_awg
Termination	solder
Termination diameter	085mm

reverse\_gender\_on\_request

### Technical information

Max. creepage and air clearance distance	09_mm	09_mm
Nominal current single contact	075_a	iec_60512_5_2
Nominal current insert	5,625 A	vde_0298_4
Test voltage	135_kv_ac	sae_13441

safety\_text

## Mechanical and environmental data

Degree of protection*	ip68
Operating temperature	40_120_c
Mating cycles	5000

mated

## Material and surface treatments

Housing	m_chrome
Contact	cu_alloy_gold

safety\_text\_2  
ul\_text  
illustrative\_text