



日月液晶显示  
东莞市日月液晶显示科技有限公司

Doc.No.:

REV : A

PAGE : 1/19

**SPEC TITLE**  
DOCUMENT CONTROL SPECIFICATION

EFFECTIVE DATE : 2017-11-07

# Specifications

**TFT-LCDmodule**

**Model No: RY24049B0-00**

**Customer name: 益杉科技**

**The project name:B5**

| <b>For Customer's Acceptance</b> |                |
|----------------------------------|----------------|
| <b>Approved by</b>               | <b>Comment</b> |
|                                  |                |

|                    | <b>Signature</b> | <b>Date</b> |
|--------------------|------------------|-------------|
| <b>Prepared by</b> |                  |             |
| <b>Checked by</b>  |                  |             |
| <b>Approved by</b> |                  |             |

**DONGGUAN RIYUE PHOTOELECTRIC CO., LTD**

**Dongguan Luyuan town Tangxia City Keyuan City Road No. 168 Le**

**Branch Industrial Park C building 3 floor**

**Tel:0769-82553159**

**Fax:0769-88004083**



Doc.No.:

REV : A

PAGE : 2/19

**SPEC TITLE**  
DOCUMENT CONTROL SPECIFICATION

EFFECTIVE DATE : 2017-11-07

## Contents

|      |  |                    |
|------|--|--------------------|
| 1    | General Description .....                  | 3                  |
| 1.1  | Features .....                             | 3                  |
| 1.2  | Application .....                          | 3                  |
| 2    | Outline Dimension .....                    | 4                  |
| 3    | Electrical Characteristics .....           | 5                  |
| 3.1  | TFT-LCD Module .....                       | 5                  |
| 3.2  | Back-Light Unit.....                       | 5                  |
| 4    | Block Diagram .....                        | 6                  |
| 5    | TFT-LCM Interface Specification .....      | 7                  |
| 6    | Description of Interface'Signal.....       | 8                  |
| 6.1  | RGB Interface Timing Characteristics ..... | 8                  |
| 6.2  | DC Characteristics .....                   | 8                  |
| 6.3  | AC Characteristics.....                    | 9                  |
| 6.4  | Reset Characteristics .....                | 9                  |
| 7    | Optical Specification.....                 | 10                 |
| 8    | Environment Absolute Maximum Ratings ..... | 13                 |
| 9    | Reliability Test Items .....               | 13                 |
| 10   | Inspection Standard.....                   | 14                 |
| 11   | Package .....                              | 15                 |
| 12   | Precautions .....                          | 16                 |
| 12.1 | Handling .....                             | 16                 |
| 12.2 | Storage.....                               | 16                 |
| 12.3 | Operation.....                             | 17                 |
| 12.4 | Touch Panel Mounting Notes .....           | <a href="#">17</a> |
| 12.5 | Others .....                               | 18                 |
| 13   | Records of Version.....                    | 19                 |



Doc.No.:

REV : A

PAGE : 3/19

**SPEC TITLE**  
DOCUMENT CONTROL SPECIFICATION

EFFECTIVE DATE : 2017-11-07

## 1 General Description

**RY24049B0-00** is a transmissive type a-Si TFT-LCD (amorphous silicon thin film transistor liquid crystal display) module, which is composed of a TFT-LCD panel, a driver circuit a backlight unit, The panel size is 2.4inch and thresolution is 240x320. High image quality a-Si TFT LCD module. Partial-screen display function is available. Sleep and Stand-by modes are available for power saving.

### 1.1 Features

| No | Item              | Specification               | Remark |
|----|-------------------|-----------------------------|--------|
| 1  | Display Mode      | High Resolution & Wide View |        |
| 2  | Screen Size       | 2.4inch (diagonal)          |        |
| 3  | Resolution        | 240XRGBX320                 |        |
| 4  | Color Number      | 262K TFT                    |        |
| 5  | Color Arrangement | RGB-stripe                  |        |
| 6  | Driver IC         | ST7789V                     |        |
| 7  | Back Light        | White LED*6                 |        |
| 8  | Viewing Direction | ALL                         |        |
| 9  | Interface         | MCU8bit                     |        |
| 10 | Surface Treatment | UV Cut                      |        |
| 11 | touch panel       | N/A                         |        |

### 1.2 Application

- ◆ Mobile phone.
- ◆ Portable multimedia device.

## 2 Outline Dimension

The mechanical detail is shown in Fig. 1 and summarized in Table 1 below.

| Parameter          | Specifications                                   | Unit              |
|--------------------|--|-------------------|
| Outline dimensions | 42.72 x60.26 x 2.45+-0.1(D) (LCM,no include FPC) | mm                |
| Active area        | 36.72(W) x48.96(H)                               | mm                |
| Resolution         | 240XRGBX320 dots                                 | -                 |
| Dot size           | 0.153x0.153                                      | mm                |
| Luminance value    | 260 (60ma 时)                                     | cd/m <sup>2</sup> |

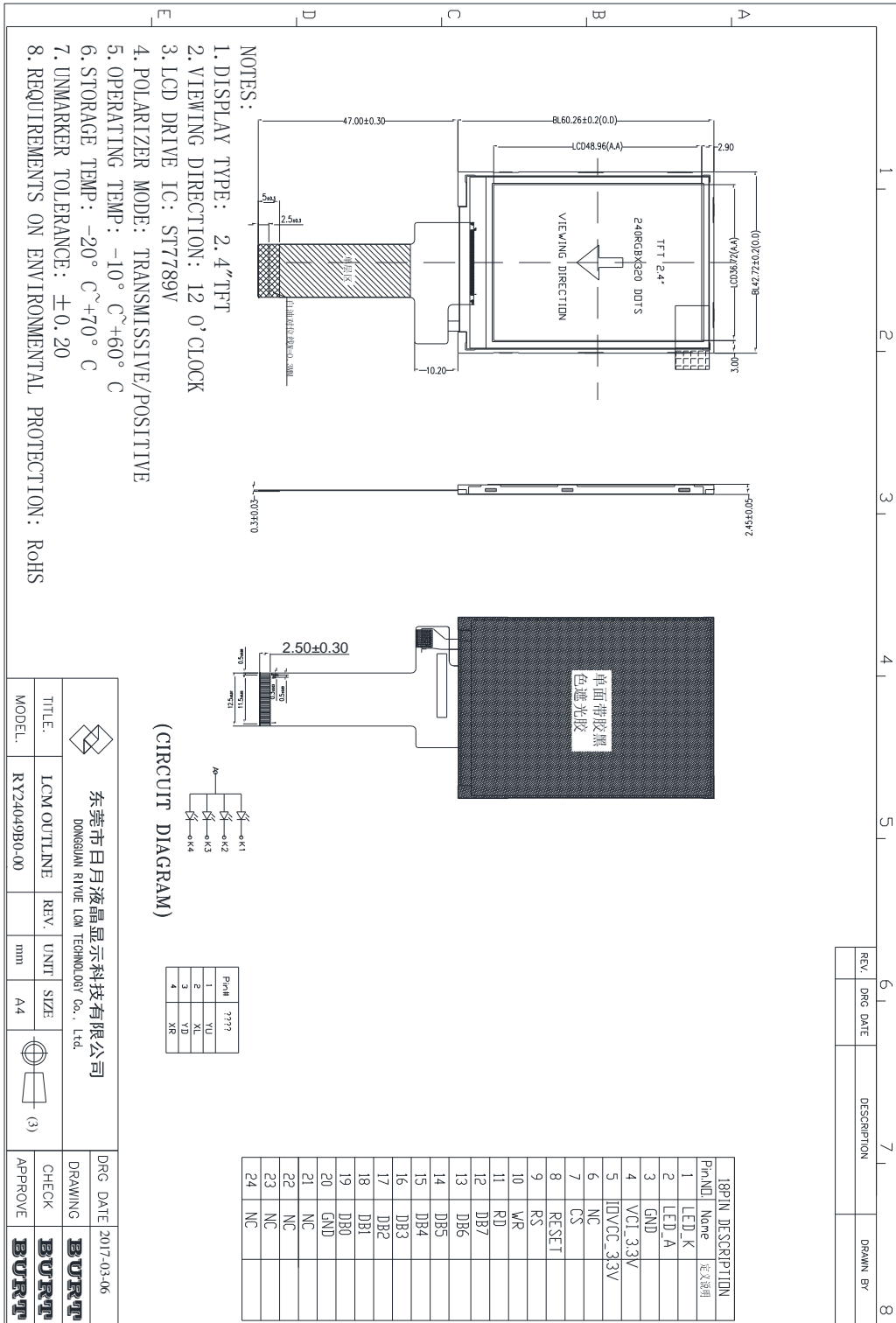

**Figure 1: Module specification of the module**



Doc.No.:

REV : A

PAGE : 5/19

**SPEC TITLE**  
DOCUMENT CONTROL SPECIFICATION

EFFECTIVE DATE : 2017-11-07

### 3 Electrical Characteristics

#### 3.1 TFT-LCD Module

| Item                               | Symbol | Unit | Condition              | Min.     | Typ. | Max.     | Note      |
|------------------------------------|--------|------|------------------------|----------|------|----------|-----------|
| <b>Power and Operation Voltage</b> |        |      |                        |          |      |          |           |
| Analog Operating Voltage           | VCI    | V    | Operating voltage      | 2.5      | 2.8  | 3.3      | Note2     |
| Logic Operating Voltage            | VDDI   | V    | I/O supply voltage     | 1.65     | 2.8  | 3.3      | Note2     |
| Digital Operating voltage          | VCORE  | V    | Digital supply voltage | -        | 1.5  | -        | Note2     |
| Gate Driver High Voltage           | VGH    | V    | -                      | 12.0     | -    | 21.0     | Note3     |
| Gate Driver Low Voltage            | VGL    | V    | -                      | -12.5    | -    | -7.0     | Note3     |
| Driver Supply Voltage              | -      | V    | [VGH-VGL]              | -        | -    | 32       | Note3     |
| <b>Input and Output</b>            |        |      |                        |          |      |          |           |
| Logic High Level Input Voltage     | VIH    | V    | -                      | 0.7*VDDI | -    | VDDI     | Note1,2,3 |
| Logic Low Level Input Voltage      | VIL    | V    | -                      | VSS      | -    | 0.3*VDDI | Note1,2,3 |
| Logic High Level Output Voltage    | VOH    | V    | IOL=-1.0mA             | 0.8*VDDI | -    | VDDI     | Note1,2,3 |
| Logic Low Level Output Voltage     | VOL    | V    | IOL=1.0mA              | VSS      | -    | 0.2*VDDI | Note1,2,3 |
| Logic High Level Input Current     | IIH    | uA   | -                      | -        | -    | 1        | Note1,2,3 |
| Logic Low Level input Current      | IIL    | uA   | -                      | -1       | -    | -        | Note1,2,3 |
| Logic Input Leakage Current        | ILEA   | uA   | VIN=VDDI or VSS        | -0.1     | -    | +0.1     | Note1,2,3 |

Note 1: VDDI=1.65 to 3.3V, VCI=2.5 to 3.3V, AGND=VSS=0V, Ta=-30 to 70 (to +85 no damage) °C.

Note2: Please supply digital VDDI voltage equal or less than analog VCI voltage.

#### 3.2 Back-Light Unit

| Item            | Symbol | Min.  | Typ. | Max. | Unit  | Remark             |
|-----------------|--------|-------|------|------|-------|--------------------|
| Current         | IF     | 60    | 70   | 80   | mA    | IF=80mA<br>IF=3.2V |
| Forward voltage | VF     | 2.9   | 3.2  | 3.5  | V     |                    |
| Chroma          | X      | 0.250 |      | 0.30 |       |                    |
|                 | Y      | 0.250 |      | 0.30 |       |                    |
| Brightness      | L      | 4000  |      |      | Cd/m2 |                    |
| Uniformity      | UBL    | 80    |      |      | %     |                    |

- 4 LEDs multiple circuit
- The luminous intensity of LED is strongly dependent on the driving current.
- It is recommended the input of backlight to be constant current rather than constant voltage.



Doc.No.:

REV : A

PAGE : 6/19

**SPEC TITLE**  
DOCUMENT CONTROL SPECIFICATION

EFFECTIVE DATE : 2017-11-07

## 5 TFT-LCM Interface Specification

| Pin No | Symbol  | Description  | Note |
|--------|---------|--|------|
| 1      | LED-K   | Power supply Cathode input for backlight   |      |
| 2      | LEDA    | Power supply Anode input for backlight   |      |
| 3      | GND     | Ground   |      |
| 4      | VCC     | Power supply input for LCM:2.8V  |      |
| 5      | IOVCC   | Power supply input for LCM:1.8V  |      |
| 6      | NC      | NC   |      |
| 7      | CS      | Chip select input pin.   |      |
| 8      | RESET   | Reset signal input Pin   |      |
| 9      | RS      | Data/Instruction select input pin<br>---RS='H ': Display data.<br>---RS='L ': Instruction data.            |      |
| 10     | WR      | A write strobe signal can be input via this pin and initiallizes a write operation when the signal is low. |      |
| 11     | RD      | A read strobe signal can be input via this pin and initiallizes a read operation when the signal is low.   |      |
| 12~19  | DB7~DB0 | DATA   |      |
| 20     | GND     | Ground   |      |
| 21~24  | NC      | NC   |      |

## 6 Description of Interface'Signal

### 6.1 RGB Interface Timing Characteristics

Table 24. (24/18/16-bit I/F, IOVCC = 1.65 to 3.30V, VCC = 2.60 to 3.30V)

| Item                                  | Symbol       | Unit | Min | Typ | Max |
|---------------------------------------|--------------|------|-----|-----|-----|
| VSYNC/HSYNC setup time                | tSYNCS       | ns   | 5   | -   | -   |
| VSYNC/HSYNC hold time                 | tSYNCH       | ns   | 5   | -   | -   |
| DE setup time                         | tENS         | ns   | 5   | -   | -   |
| DE hold time                          | tENH         | ns   | 5   | -   | -   |
| PCLK "Low" level pulse width          | PWDL         | ns   | 10  | -   | -   |
| PCLK "High" level pulse width         | PWDH         | ns   | 10  | -   | -   |
| PCLK cycle time                       | tCYCD        | ns   | 20  | -   | -   |
| Data setup time                       | tPDS         | ns   | 6   | -   | -   |
| Date hold time                        | tPDH         | ns   | 6   | -   | -   |
| PCLK, VSYNC, HSYNC, DE rise/fall time | trgbr, trgbf | ns   | -   | -   | 13  |

### 6.2 DC Characteristics

Table 15. DC Characteristics

| Item   | Symbol           | Unit | Test Condition                           | Min       | Typ | Max       | Notes |
|--|------------------|------|--|-----------|-----|-----------|-------|
| Input high voltage   | V <sub>IH</sub>  | V    | IOVCC = 1.65~3.3                         | 0.8*IOVCC | -   | IOVCC     |       |
| Input low voltage  | V <sub>IL</sub>  | V    | IOVCC = 1.65~3.3                         | -0.3      | -   | 0.2*IOVCC |       |
| Output high voltage (1)<br>(DB17-0, SDO)                                   | V <sub>OH1</sub> | V    | IOVCC = 1.65~3.3<br>IOH = 0.1mA          | 0.8*IOVCC | -   | -         |       |
| Output low voltage (1)<br>(DB17-0, SDO)                                    | V <sub>OL1</sub> | V    | IOVCC = 1.65~3.3<br>IOL = 0.1mA          | -         | -   | 0.2*IOVCC |       |
| I/O leakage current  | I <sub>LI</sub>  | μA   | Vin = 0~IOVCC                            | -1        | -   | 1         |       |
| Current consumption during standby mode:<br>(IOVCC - GND) +<br>(VCC - GND) | I <sub>ST</sub>  | μA   | IOVCC = VCC = VCI =<br>2.8V<br>Ta = 25°C | -         | 1.4 | 10        |       |

### 6.3 AC Characteristics

| Item                                  |                    | Symbol     | Unit | Min | Typ | Max |
|---------------------------------------|--------------------|------------|------|-----|-----|-----|
| Serial clock cycle time               | Write (received)   | tSCYC      | ns   | 20  | -   | -   |
|                                       | Read (transmitted) |            |      | 100 | -   | -   |
| Serial clock "High" level pulse width | Write (received)   | tSCH       | ns   | 10  | -   | -   |
|                                       | Read (transmitted) |            |      | 50  | -   | -   |
| Serial clock "Low" level pulse width  | Write (received)   | tSCL       | ns   | 10  | -   | -   |
|                                       | Read (transmitted) |            |      | 50  | -   | -   |
| Serial clock rise/fall time           |                    | tscr, tscf | ns   | -   | -   | 20  |
| Chip select setup time                |                    | tCSU       | ns   | 20  | -   | -   |
| Chip select hold time                 |                    | tCH        | ns   | 10  | -   | -   |
| Serial input data setup time          |                    | tSISU      | ns   | 5   | -   | -   |
| Serial input data hold time           |                    | tSIH       | ns   | 10  | -   | -   |
| Serial output data setup time         |                    | tSOD       | ns   | 80  | -   | 150 |
| Serial output data hold time          |                    | tSOH       | ns   | -   | -   | 80  |

### 6.4 Reset Characteristics

Table 23. (Condition: IOVCC = 1.65 to 3.30V, VCC = 2.60 to 3.30V)

| Item                    | Symbol | Unit | Min | Typ | Max |
|-------------------------|--------|------|-----|-----|-----|
| Reset "Low" level width | tRES   | ms   | 1   | -   | -   |
| Reset rise time         | trRES  | μs   | -   | -   | 10  |

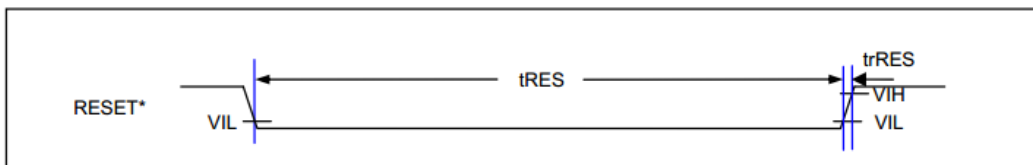





Doc.No.:

REV : A

PAGE : 9/19

**SPEC TITLE**  
DOCUMENT CONTROL SPECIFICATION

EFFECTIVE DATE : 2017-11-07

### 7. Optical Specification

| C. Optical specifications  |        |                    |               |       |       |      |            |
|--|--------|--------------------|---------------|-------|-------|------|------------|
| Item   | Symbol | Condition          | Specification |       |       | Unit | Remark     |
|  |        |                    | Min.          | Typ.  | Max.  |      |            |
| Response time (By Quick)   | Tr+Tf  | $\theta = 0^\circ$ | -             | 30    |       | ms   | Note 5     |
| Contrast ratio   | CR     | $\theta = 0^\circ$ | -             | 250   | -     |      | Note 2,6   |
| Viewing angle  | Top    | $CR \geq 10$       | -             | 45    | -     | deg. | Note 2,6,7 |
|  | Bottom | $CR \geq 10$       | -             | 20    | -     |      |            |
|  | Left   | $CR \geq 10$       | -             | 45    | -     |      |            |
|  | Right  | $CR \geq 10$       | -             | 45    | -     |      |            |
| Color chromaticity<br>( CF only with ITO,<br>light source is C<br>light, CIE 1931) | Wx     | $\theta = 0^\circ$ | -0.02         | 0.308 | +0.02 |      | Note 3     |
|  | Wy     |                    |               | 0.325 |       |      |            |
|  | Rx     |                    |               | 0.612 |       |      |            |
|  | Ry     |                    |               | 0.329 |       |      |            |
|  | Gx     |                    |               | 0.299 |       |      |            |
|  | Gy     |                    |               | 0.567 |       |      |            |
|  | Bx     |                    |               | 0.144 |       |      |            |
| By   | 0.110  |                    |               |       |       |      |            |
| NTSC   |        |                    | -             | 55    | -     | %    | Note 3     |
| Cross talk   | Ct     |                    | -             | 2     | -     | %    | Note 9     |
| Transmittance  | Trans  |                    | -             | 5     | -     | %    | Note 4     |

贴宽视角片:

Top:60

Bottom: 50

Left: 60

Right: 60

Note 1: The brightness test equipment setup

$I_B=60\text{mA}$ , Field= $2^\circ$  (As measuring “black” image, field= $2^\circ$  is the best testing condition.)

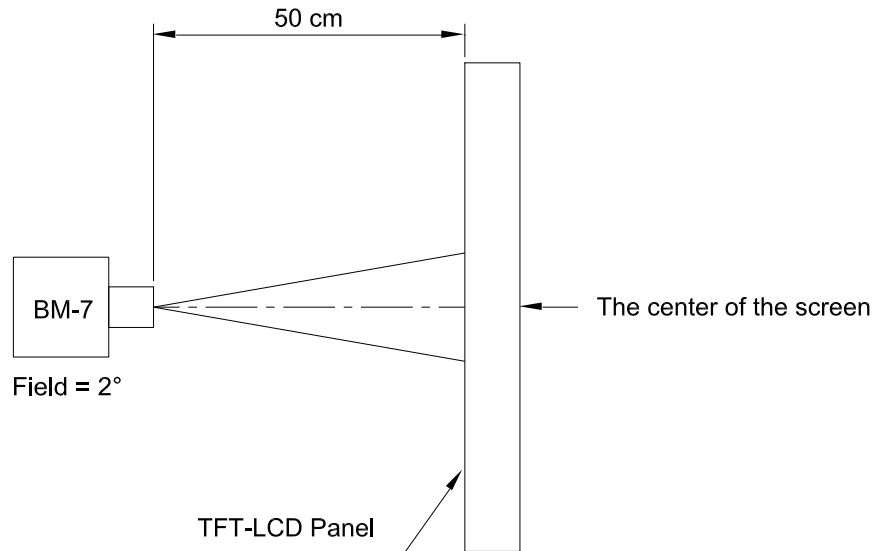

Note 2: Definition of contrast ratio (C.R)

$$C.R = \frac{\text{Brightness When LCD is at "White" State}}{\text{Brightness When LCD is at "Black" State}}$$

Note 3: Definition of response  
time



日月液晶显示  
东莞市日月液晶显示科技有限公司

Doc.No.:

REV : A

PAGE : 11/19

**SPEC TITLE**

DOCUMENT CONTROL SPECIFICATION

EFFECTIVE DATE : 2017-11-07

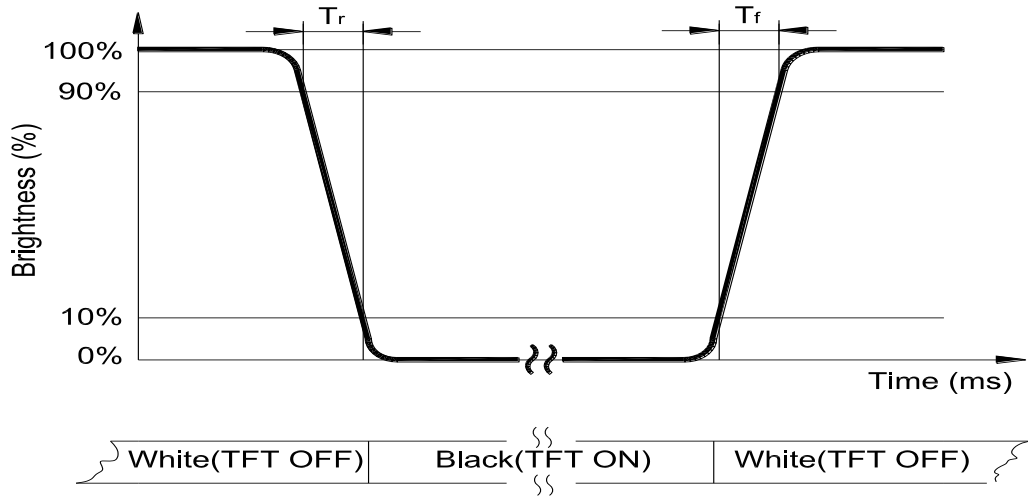

Note 4: Definition of viewing angle

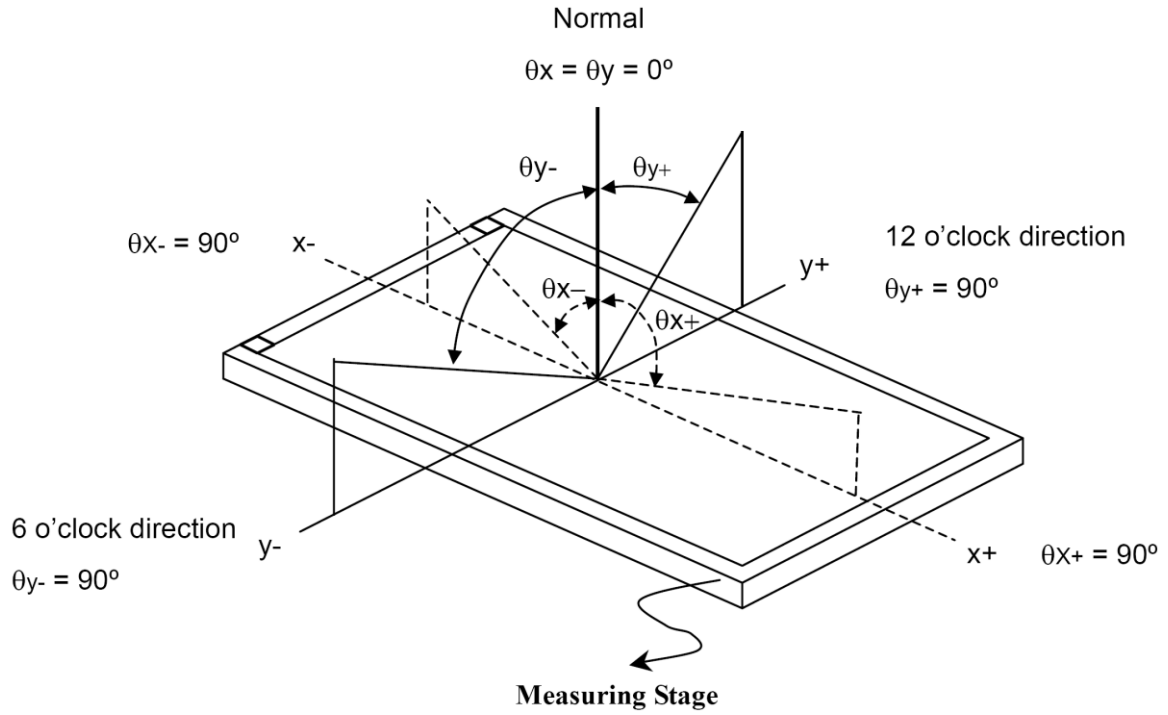

Note 5: Definition of uniformity (**Un**)

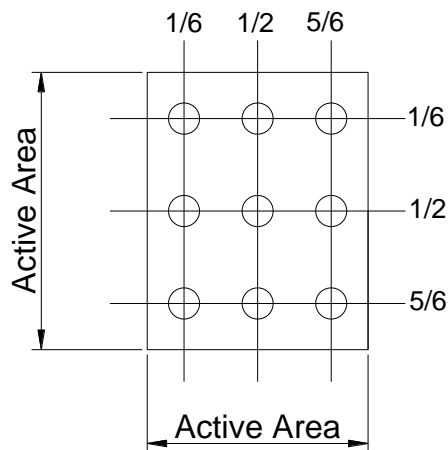

$$Un = \frac{Bmin}{Bmax} \times 100\%$$

## 8 Environment Absolute Maximum Ratings

| Item                        | Symbol | Min | Max | Unit | Remark  |
|-----------------------------|--------|-----|-----|------|---------|
| Operation temperature range | Top    | -10 | 60  | °C   | Ambient |
| Storage temperature range   | Tst    | -20 | 70  | °C   | Ambient |

- Corrosive gas environment is not acceptable.
- TFT-LCD color will change slightly depending on environment temperature. This phenomenon is reversible. Current reduction rate of LED backlight is according to the graph indicated below:

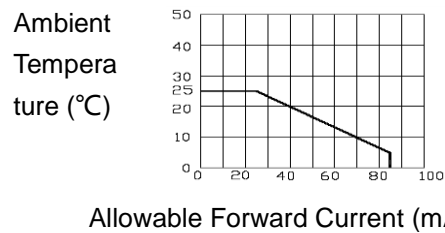

## 9 Reliability Test Items

| Item  | Test Condition  |                              | Criterion  |
|---|---|------------------------------|--|
| High Temperature Storage                        | 70 °C, 240 hrs  |                              | There should be no change which might affect the practical display function when the display quality test is conducted under normal operating condition. |
| Low Temperature Storage                         | -20 °C, 240 hrs   |                              |  |
| High Temp. & High Humidity Storage              | 60 °C, 85% RH, 240 hrs  |                              |  |
| Vibration Test<br>(Non-operating)               | Freq.:10~55~10 Hz, Amp.:1.5mm<br>1 hr for each direction of X, Y, Z |                              |  |
| Electrostatic Discharge Test<br>(Non-operating) | Terminals   | 150 pF, 0 Ω, ±300 V, Contact |  |
|   | Panel   | 150 pF, 330 Ω, ±8 KV, Air    |  |
| Thermal Shock<br>(Static)                       | -30°C, 30 min /80°C, 30 min, 20 cycles                              |                              |  |
| High Temperature Operation                      | 60 °C, 240 hrs  |                              |  |
| Low temperature Operation                       | -10 °C, 240 hrs   |                              |  |
| High Temperature & High Humidity<br>(Operating) | 50 °C, 90% RH, 240 hrs  |                              |  |
| FPC Peeling Strength Test                       | Pull speed: 50 mm/min, +90°,  |                              | > 400gf/cm   |



## 10 Inspection Standard

This standard apply to TFT module specification.

### 1. Inspection condition:

Under daylight lamp 20~40W, product distance inspector'eye 30cm.incline degree 30°

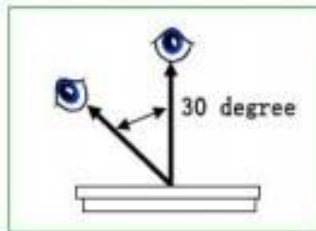

### 2. Inspection standard

| NO.                     | Item                 | Inspection standard  | Rate           |                   |                   |        |                         |        |                         |                      |                         |              |                      |   |       |            |                                |  |
|-------------------------|----------------------|--|----------------|-------------------|-------------------|--------|-------------------------|--------|-------------------------|----------------------|-------------------------|--------------|----------------------|---|-------|------------|--------------------------------|--|
| 2.1                     | Dot                  | <p>Case of Dot defect is below</p> <p>① Bright Dot (whit spot) : "0"</p> <p>② Dark Dot (black spot) : "0" (In case of Dark Dot on Main TFT LCD)</p> <p>- NG if there's full Dot defect.</p> <p>- Damaged less than the size of sub-pixel is not counted as defect</p> <p>- Dots darker than the size of sub-pixel are not defined as bright dot defect</p> <table border="1"> <thead> <tr> <th>area size (mm)</th> <th>Acceptable number</th> </tr> </thead> <tbody> <tr> <td><math>\Phi \leq 0.10</math></td> <td>ignore</td> </tr> <tr> <td><math>0.10 &lt; \Phi \leq 0.15</math></td> <td>3</td> </tr> <tr> <td><math>0.15 &lt; \Phi \leq 0.20</math></td> <td>2</td> </tr> <tr> <td><math>0.25 &lt; \Phi \leq 0.25</math></td> <td>1</td> </tr> <tr> <td><math>0.25 &lt; \Phi</math></td> <td>0</td> </tr> </tbody> </table> | area size (mm) | Acceptable number | $\Phi \leq 0.10$  | ignore | $0.10 < \Phi \leq 0.15$ | 3      | $0.15 < \Phi \leq 0.20$ | 2                    | $0.25 < \Phi \leq 0.25$ | 1            | $0.25 < \Phi$        | 0 | minor |            |                                |  |
| area size (mm)          | Acceptable number    |  |                |                   |                   |        |                         |        |                         |                      |                         |              |                      |   |       |            |                                |  |
| $\Phi \leq 0.10$        | ignore               |  |                |                   |                   |        |                         |        |                         |                      |                         |              |                      |   |       |            |                                |  |
| $0.10 < \Phi \leq 0.15$ | 3                    |  |                |                   |                   |        |                         |        |                         |                      |                         |              |                      |   |       |            |                                |  |
| $0.15 < \Phi \leq 0.20$ | 2                    |  |                |                   |                   |        |                         |        |                         |                      |                         |              |                      |   |       |            |                                |  |
| $0.25 < \Phi \leq 0.25$ | 1                    |  |                |                   |                   |        |                         |        |                         |                      |                         |              |                      |   |       |            |                                |  |
| $0.25 < \Phi$           | 0                    |  |                |                   |                   |        |                         |        |                         |                      |                         |              |                      |   |       |            |                                |  |
| 2.2                     | line                 | <table border="1"> <thead> <tr> <th colspan="2">Size (mm)</th> <th>Acceptable number</th> </tr> </thead> <tbody> <tr> <td>ignore</td> <td><math>W \leq 0.03</math></td> <td>ignore</td> </tr> <tr> <td><math>L \leq 4.0</math></td> <td><math>0.03 &lt; W \leq 0.04</math></td> <td>2</td> </tr> <tr> <td><math>L \leq 4.0</math></td> <td><math>0.04 &lt; W \leq 0.05</math></td> <td>1</td> </tr> <tr> <td></td> <td><math>0.05 &lt; W</math></td> <td>Treat with dot non-conformance</td> </tr> </tbody> </table>   | Size (mm)      |                   | Acceptable number | ignore | $W \leq 0.03$           | ignore | $L \leq 4.0$            | $0.03 < W \leq 0.04$ | 2                       | $L \leq 4.0$ | $0.04 < W \leq 0.05$ | 1 |       | $0.05 < W$ | Treat with dot non-conformance |  |
| Size (mm)               |                      | Acceptable number  |                |                   |                   |        |                         |        |                         |                      |                         |              |                      |   |       |            |                                |  |
| ignore                  | $W \leq 0.03$        | ignore   |                |                   |                   |        |                         |        |                         |                      |                         |              |                      |   |       |            |                                |  |
| $L \leq 4.0$            | $0.03 < W \leq 0.04$ | 2  |                |                   |                   |        |                         |        |                         |                      |                         |              |                      |   |       |            |                                |  |
| $L \leq 4.0$            | $0.04 < W \leq 0.05$ | 1  |                |                   |                   |        |                         |        |                         |                      |                         |              |                      |   |       |            |                                |  |
|                         | $0.05 < W$           | Treat with dot non-conformance   |                |                   |                   |        |                         |        |                         |                      |                         |              |                      |   |       |            |                                |  |

## 11 Package

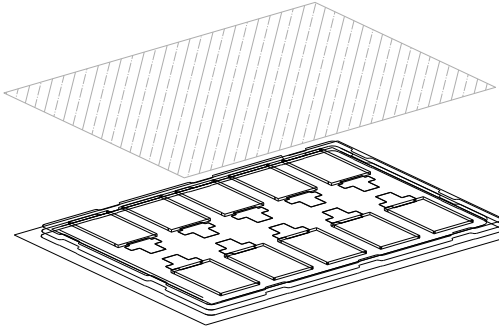
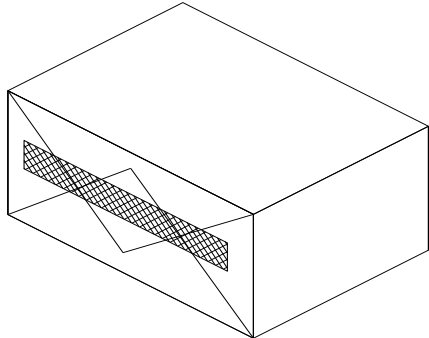
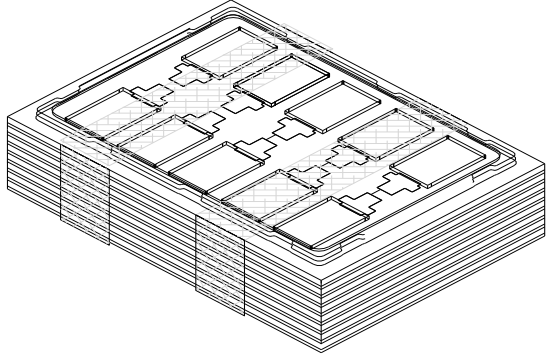
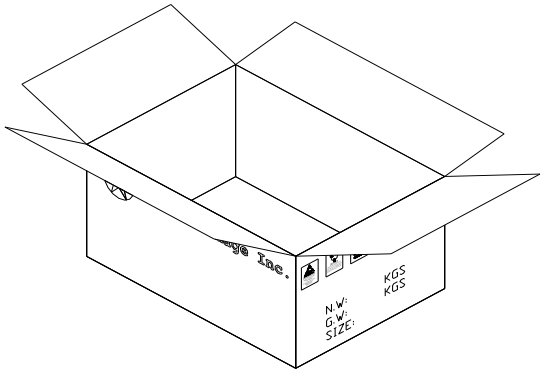
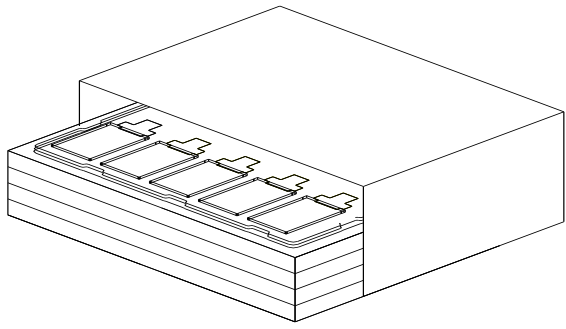
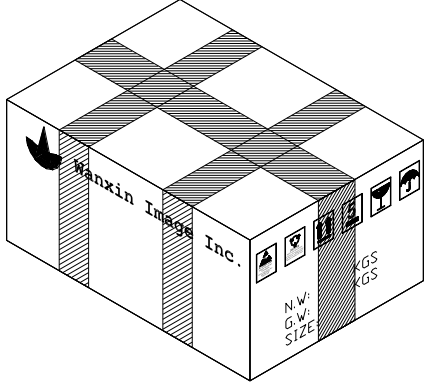
|  |   |
|--|---|
| <p>1</p>    | <p>4</p>    |
| <p>10 pcs per tray + 1 cover (EPE)</p>   | <p>Packing bag</p>  |
| <p>2</p>  | <p>5</p>  |
| <p>15 trays + 1 dummy tray = 150 ps</p>  | <p>Putting bag into carton<br/>Protected by 2 pieces of cushion EPE sheet</p>                 |
| <p>3</p>  | <p>6</p>  |
| <p>Putting trays into anti-electrostatic bag</p>   | <p>Packing carton with sealing tape</p>   |



Doc.No.:

REV : A

PAGE : 16/19

**SPEC TITLE**  
DOCUMENT CONTROL SPECIFICATION

EFFECTIVE DATE : 2017-11-07

Carton outline size: 400×295×145 (mm)

## 12 Precautions

Please pay attentions to the followings as using the LCD module.

### 12.1 Handling

- (a) Do not apply strong mechanical stress like drop, shock or any force to LCD module. It may cause improper operation, even damage.
- (b) Because the polarizer is very fragile and easy to be damaged, do not hit, press or rub the display surface with hard materials.
- (c) Do not put heavy or hard material on the display surface, and do not stack LCD modules.
- (d) If the display surface is dirty, please wipe the surface softly with cotton swab or clean cloth.
- (e) Avoid using Ketone type materials (e.g. Acetone), Toluene, Ethyl acid or Methyl chloride to clean the display surface. It might damage the touch panel surface permanently. The recommended solvents are water and Isopropyl alcohol.
- (f) Wipe off water droplets or oil immediately.
- (g) Protect the LCD module from ESD. It will damage the LSI and the electronic circuit.
- (h) Do not touch the output pins directly with bare hands.
- (i) Do not disassemble the LCD module.
- (j) Do not lift the FPC of Touch Panel.

### 12.2 Storage

- (a) Do not leave the LCD modules in high temperature, especially in high humidity for a long time.
- (b) Do not expose the LCD modules to sunlight directly.
- (c) The liquid crystal is deteriorated by ultraviolet. Do not leave it in strong





Doc.No.:

REV : A

PAGE : 17/19

**SPEC TITLE**  
DOCUMENT CONTROL SPECIFICATION

EFFECTIVE DATE : 2017-11-07

ultraviolet ray for a long time.

- (d) Avoid condensation of water. It may cause improper operation.
- (e) Please stack only up to the number stated on carton box for storage and transportation. Excessive weight will cause deformation and damage of carton box.

### **12.3Operation**

- (a) When mounting or dismantling the LCD modules, turn the power off.
- (b) Protect the LCD modules from electric shock.
- (c) The Driver IC control algorithms stated above should always obeyed to avoid damaging the LSI and electronic circuit.
- (d) Be careful to avoid mixing up the polarity of power supply for backlight.
- (e) Absolute maximum rating specified above has to be always kept in any case. Exceeding it may cause non-recoverable damage of electronic components or, nevertheless, burning.
- (f) When a static image is displayed for a long time, remnant image is likely to occur.
- (g) Be sure to avoid bending the FPC to an acute shape, it might break FPC.
- (h) Most of the touch screens have air vent to equalize the inside air pressure to the outside one. The air vent must be open and liquid contact must be avoided as the liquid may be absorbed if the liquid is accumulated near the air vent.
- (i) For the fragility of ITO film, it should avoid to use too tapering pen as the input material.

### **12.4Touch Panel Mounting Notes**

- (a) If a cushion is used between bezel/housing and film must be choose as free as enough to absorb the expansion and contraction to avoid the distortion of film.
- (b) The cushion must be placed out of the Viewing Area.
- (c) Bezel/Housing edge must be posited between Key Area and Viewing Area. The edge enters the Key Area may cause unexpected input if the gap is too narrow or foreign particles like dusts exist between Bezel/Housing and ITO film.

|  |                             |              |
|--|-----------------------------|--------------|
|  <b>日月液晶显示</b><br>东莞市日月液晶显示科技有限公司 | Doc.No.:                    |              |
|  | REV : A                     | PAGE : 18/19 |
| <b>SPEC TITLE</b><br>DOCUMENT CONTROL SPECIFICATION  | EFFECTIVE DATE : 2017-11-07 |              |

(d) Mounting example:

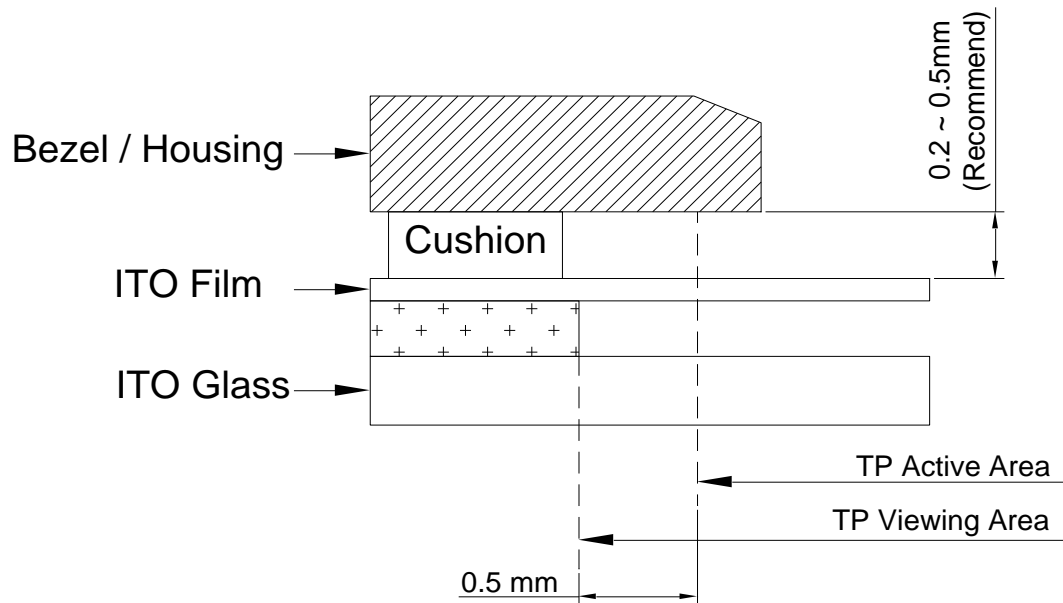

The corner part has conductivity. Do not touch any metal part after mounting.

### 12.5Others

- If the liquid crystal leaks from the panel, it should be kept away from the eyes or mouth.
- For the fragility of polarizer, it is recommended to attach a transparent protective plate over the display surface.
- It is recommended to peel off the protection film on the polarizer slowly so that the electrostatic charge can be minimized.



Doc.No.:

REV : A

PAGE : 19/19

**SPEC TITLE**  
DOCUMENT CONTROL SPECIFICATION

EFFECTIVE DATE : 2017-11-07

### 13 Records of Version

| Version | Revise Date | Page | Content      |
|---------|-------------|------|--------------|
| A       | 2013-11-21  | All  | New released |
|         |             |      |              |
|         |             |      |              |
|         |             |      |              |
|         |             |      |              |
|         |             |      |              |
| 9       |             |      |              |
|         |             |      |              |