

RobuST precision dual operational amplifier

Datasheet - production data

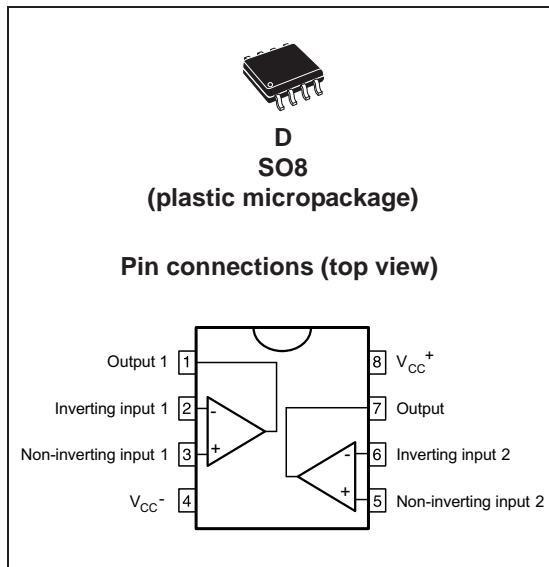

- Designed and manufactured to meet sub ppm quality goals
- Advanced mold and frame designs for superior resilience to harsh environments (acceleration, EMI, thermal, humidity)
- Extended screening capability on request
- Single fabrication, assembly and test site
- Temperature range (-40 °C to 125 °C)

Applications

- Aerospace and defense
- Harsh environments

Description

The RT512A device is a high-performance, dual operational amplifier with frequency and phase compensation built into the chip. The internal phase compensation allows stable operation in voltage follower configurations in spite of its high gain bandwidth.

The circuit presents very stable electrical characteristics over the entire supply voltage range and it is particularly intended for aerospace and defense applications.

Features

- Low input offset voltage: 500 μ V max. (A version)
- Low power consumption
- Short-circuit protection
- Low distortion, low noise
- High gain bandwidth product: 3 MHz
- High channel separation
- ESD protection 2 kV
- Macromodel included in this specification
- Intended for use in aerospace and defense applications:
 - Dedicated traceability and part marking
 - Approval documents available for production parts
 - Adapted extended life time and obsolescence management
 - Extended product change notification process

Contents

| | | |
|----------|--|-----------|
| 1 | Absolute maximum ratings and operating conditions | 3 |
| 2 | Schematic diagram | 4 |
| 3 | Electrical characteristics | 5 |
| 4 | Macromodel | 10 |
| | 4.1 Important notes concerning this macromodel | 10 |
| | 4.2 Electrical characteristics from macromodelization | 10 |
| | 4.3 Macromodel code | 11 |
| 5 | Package information | 13 |
| | 5.1 SO8 package information | 14 |
| 6 | Ordering information | 15 |
| 7 | Revision history | 15 |

1 Absolute maximum ratings and operating conditions

Table 1. Absolute maximum ratings

| Symbol | Parameter | Value | Unit |
|------------|---|-------------------|------|
| V_{CC} | Supply voltage | ± 18 | V |
| V_{in} | Input voltage | $\pm V_{CC}$ | |
| V_{id} | Differential input voltage | $\pm(V_{CC} - 1)$ | |
| R_{thja} | Thermal resistance junction-to-ambient ⁽¹⁾ | 125 | °C/W |
| R_{thjc} | Thermal resistance junction-to-case ⁽¹⁾ | 40 | |
| T_j | Junction temperature | 150 | °C |
| T_{stg} | Storage temperature range | -65 to 150 | |
| ESD | HBM: human body model ⁽²⁾ | 2 | kV |
| | MM: machine model ⁽³⁾ | 200 | V |
| | CDM: charged device model ⁽⁴⁾ | 1.5 | kV |

- Short-circuits can cause excessive heating and destructive dissipation. R_{th} are typical values.
- Human body model: a 100 pF capacitor is charged to the specified voltage, then discharged through a 1.5 k Ω resistor between two pins of the device. This is done for all couples of connected pin combinations while the other pins are floating.
- Machine model: a 200 pF capacitor is charged to the specified voltage, then discharged directly between two pins of the device with no external series resistor (internal resistor < 5 Ω). This is done for all couples of connected pin combinations while the other pins are floating.
- Charged device model: all pins and the package are charged together to the specified voltage and then discharged directly to ground through only one pin. This is done for all pins.

Table 2. Operating conditions

| Symbol | Parameter | Value | Unit |
|------------|--------------------------------------|--|------|
| V_{CC} | Supply voltage ⁽¹⁾ | 6 to 30V | V |
| V_{icm} | Common mode input voltage range | $(V_{CC-}) + 1.5$ to $(V_{CC+}) - 1.5$ | |
| T_{oper} | Operating free air temperature range | -40 to 125 | °C |

- Value with respect to V_{CC-} pin

2 Schematic diagram

Figure 1. Schematic diagram (1/2 RT512A)

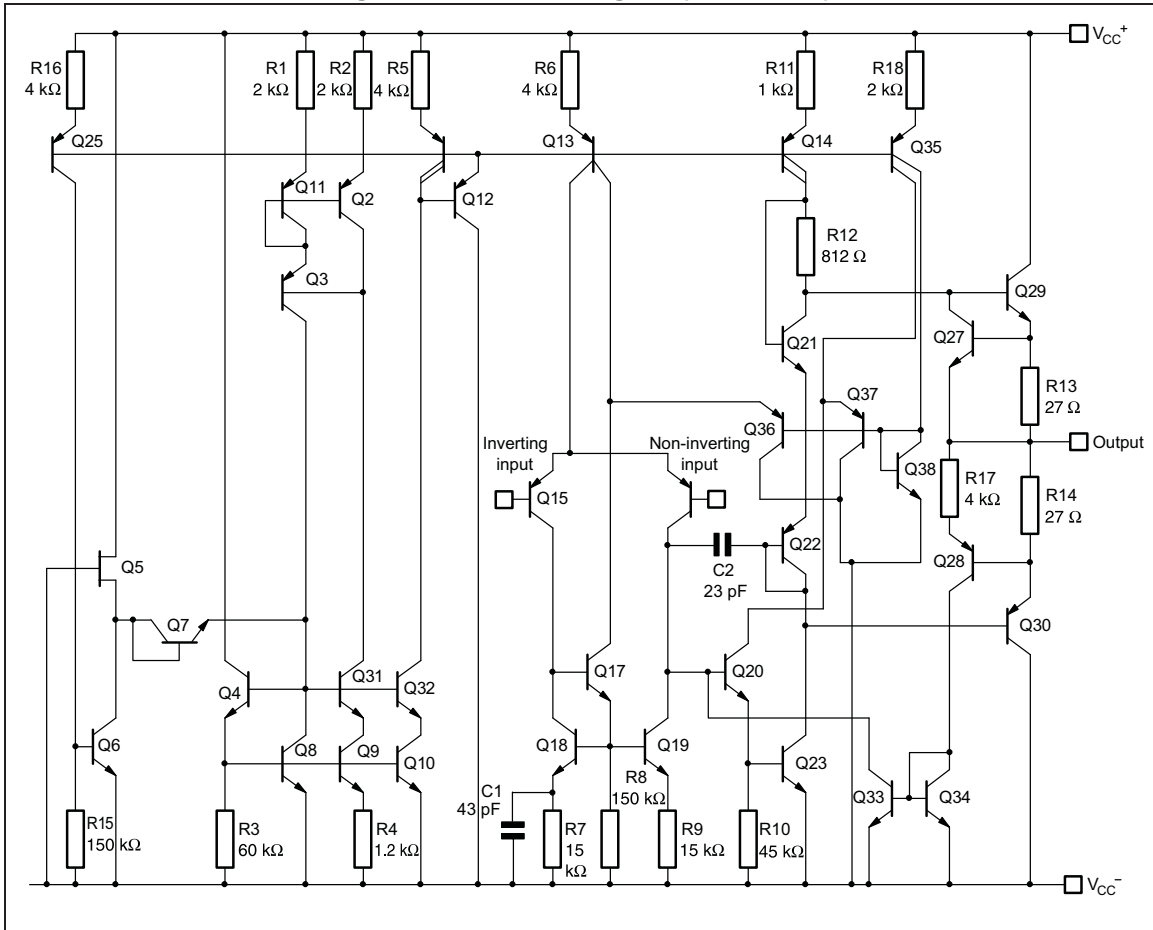

3 Electrical characteristics

Table 3. $V_{CC} = \pm 15\text{ V}$, $T_{amb} = 25\text{ }^\circ\text{C}$ (unless otherwise specified)

| Symbol | Parameter | Min. | Typ. | Max. | Unit |
|-----------------|---|----------|---------------|-------------|--------------------------------------|
| I_{CC} | Supply current (per channel) $T_{min} \leq T_{amb} \leq T_{max}$ | | 0.5 | 0.6 0.75 | mA |
| I_{ib} | Input bias current $T_{min} \leq T_{amb} \leq T_{max}$ | | 50 | 150 300 | nA |
| R_{in} | Input resistance, $f = 1\text{ kHz}$ | | 1 | | M Ω |
| V_{io} | Input offset voltage $T_{min} \leq T_{amb} \leq T_{max}$ | | | 0.5 1.5 | mV |
| ΔV_{io} | Input offset voltage drift, $T_{min} \leq T_{amb} \leq T_{max}$ | | 2 | | $\mu\text{V}/^\circ\text{C}$ |
| I_{io} | Input offset current $T_{min} \leq T_{amb} \leq T_{max}$ | | 5 | 20 40 | nA |
| ΔI_{io} | Input offset current drift, $T_{min} \leq T_{amb} \leq T_{max}$ | | 0.08 | | nA/ $^\circ\text{C}$ |
| I_{os} | Output short-circuit current | | 23 | | mA |
| A_{vd} | Large signal voltage gain $R_L = 2\text{ k}\Omega$, $V_{CC} = \pm 15\text{ V}$, $T_{min} \leq T_{amb} \leq T_{max}$ $V_{CC} = \pm 4\text{ V}$ | 90 | 100 95 | | dB |
| GBP | Gain bandwidth product, $f = 100\text{ kHz}$ | 1.8 | 3 | | MHz |
| e_n | Equivalent input noise voltage, $f = 1\text{ kHz}$ $R_s = 50\text{ }\Omega$ $R_s = 1\text{ k}\Omega$ $R_s = 10\text{ k}\Omega$ | | 8 10 18 | | $\frac{\text{nV}}{\sqrt{\text{Hz}}}$ |
| THD | Total harmonic distortion $A_v = 20\text{ dB}$, $R_L = 2\text{ k}\Omega$ $V_o = 2\text{ V}_{pp}$, $f = 1\text{ kHz}$ | | 0.03 | | % |
| $\pm V_{opp}$ | Output voltage swing $R_L = 2\text{ k}\Omega$, $V_{CC} = \pm 15\text{ V}$, $T_{min} \leq T_{amb} \leq T_{max}$ $V_{CC} = \pm 4\text{ V}$ | ± 13 | ± 3 | | V |
| V_{opp} | Large signal voltage swing $R_L = 10\text{ k}\Omega$, $f = 10\text{ kHz}$ | | 28 | | V_{pp} |
| SR | Slew rate Unity gain, $R_L = 2\text{ k}\Omega$ | 0.8 | 1.5 | | V/ μs |
| CMR | Common mode rejection ratio $\text{CMR} = 20 \log (\Delta V_{ic}/\Delta V_{io})$ ($V_{ic} = -10\text{ V}$ to 10 V , $V_{out} = V_{CC}/2$, $R_L > 1\text{ M}\Omega$) | 90 | | | dB |
| SVR | Supply voltage rejection ratio $20 \log (\Delta V_{CC}/\Delta V_{io})$ ($V_{CC} = \pm 4\text{ V}$ to $\pm 15\text{ V}$, $V_{out} = V_{icm} = V_{CC}/2$) | 90 | | | |
| V_{o1}/V_{o2} | Channel separation, $f = 1\text{ kHz}$ | | 120 | | |

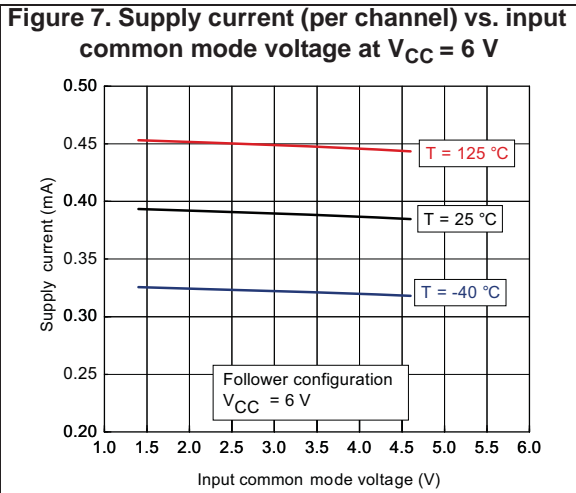
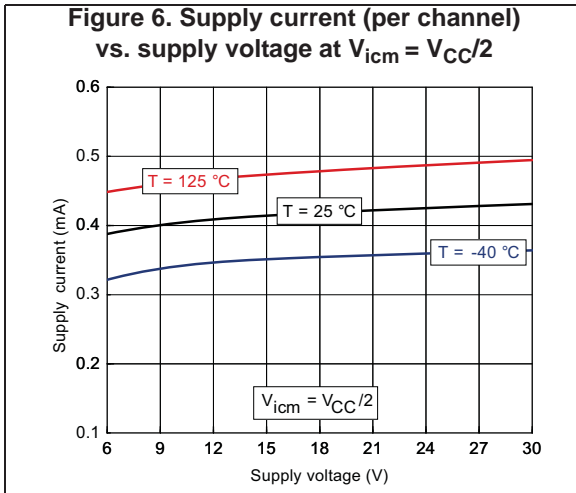
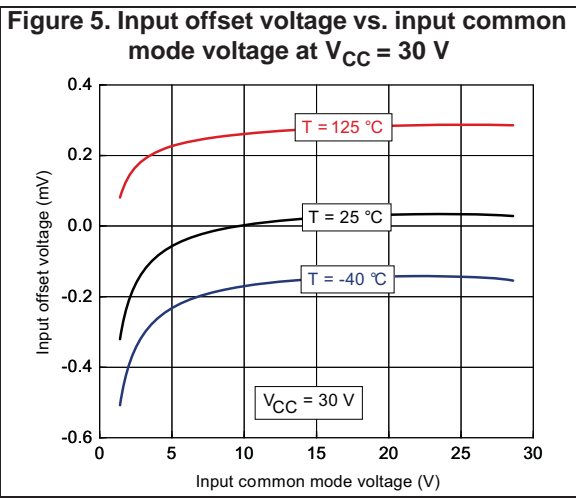
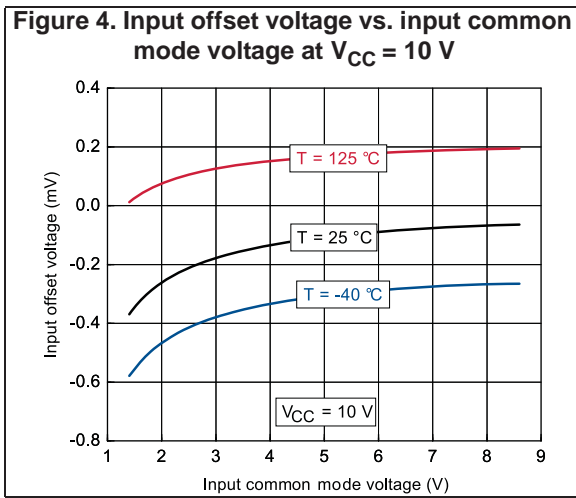
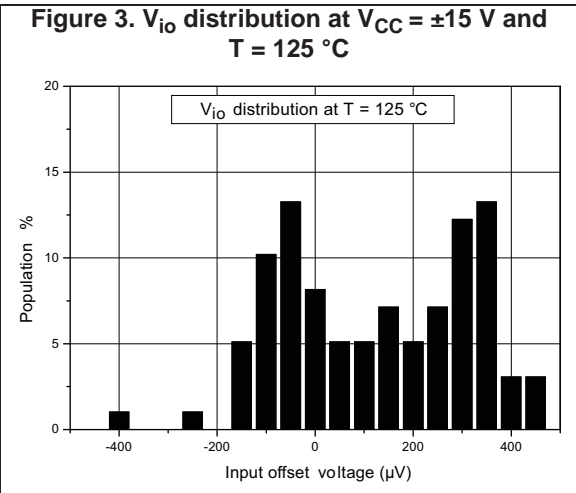
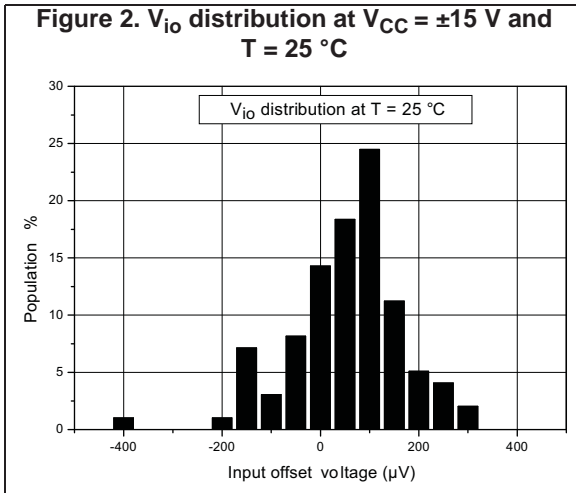

Figure 8. Supply current (per channel) vs. input common mode voltage at $V_{CC} = 10\text{ V}$

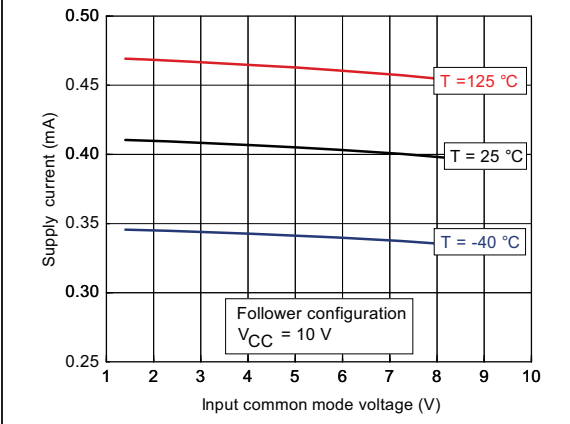

Figure 9. Supply current (per channel) vs. input common mode voltage at $V_{CC} = 30\text{ V}$

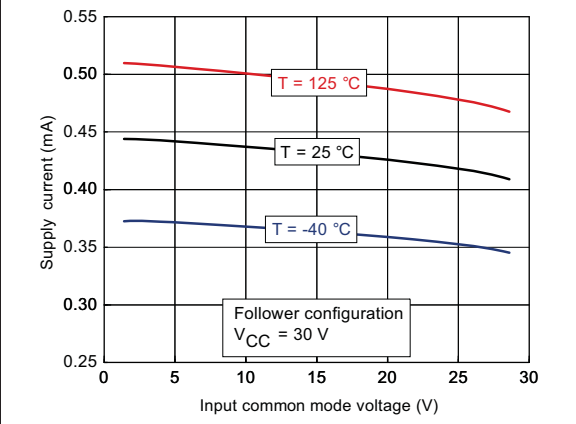

Figure 10. Output current vs. supply voltage at $V_{icm} = V_{CC}/2$

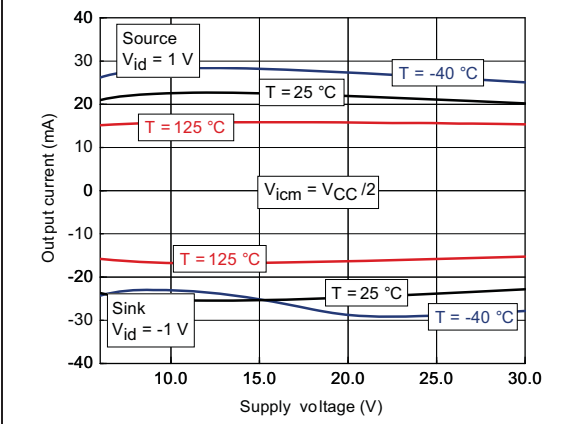

Figure 11. Output current vs. output voltage at $V_{CC} = 5\text{ V}$

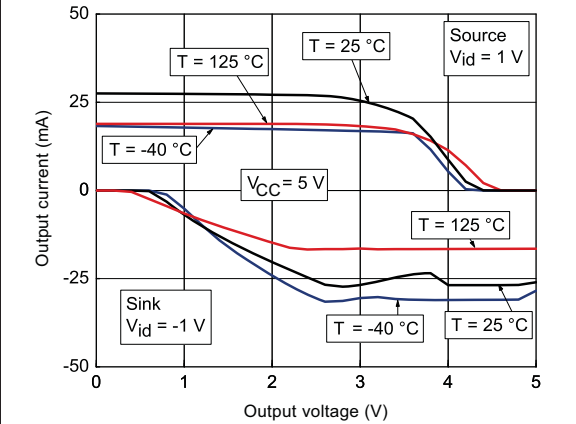

Figure 12. Output current vs. output voltage at $V_{CC} = 30\text{ V}$

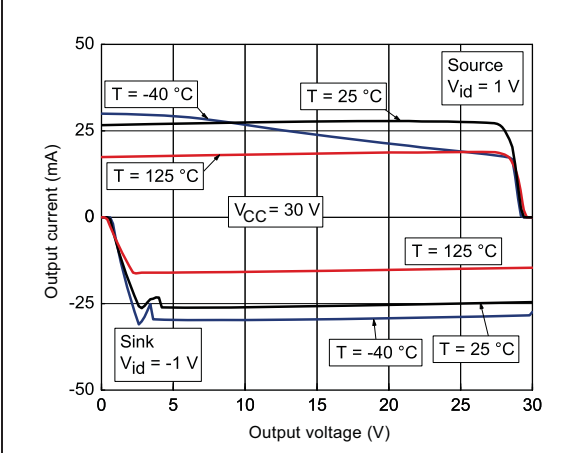

Figure 13. Voltage gain and phase for different capacitive loads at $V_{CC} = 6\text{ V}$, $V_{icm} = 3\text{ V}$ and $T = 25\text{ °C}$

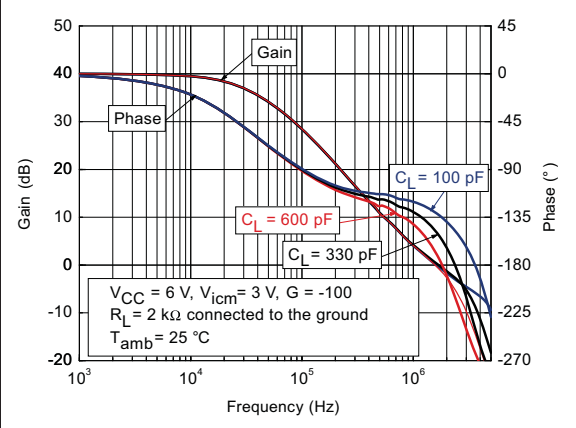

Figure 14. Voltage gain and phase for different capacitive loads at $V_{CC} = 10\text{ V}$, $V_{icm} = 5\text{ V}$ and $T = 25\text{ }^\circ\text{C}$

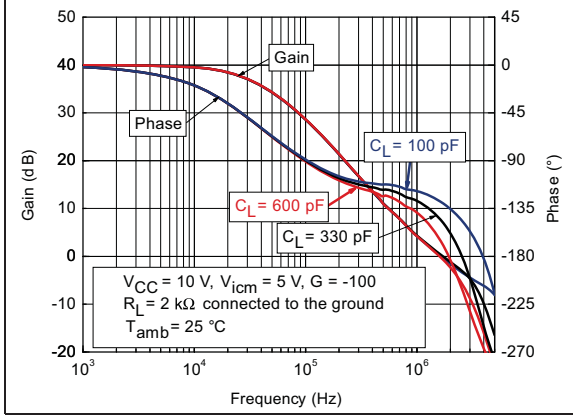

Figure 15. Voltage gain and phase for different capacitive loads at $V_{CC} = 30\text{ V}$, $V_{icm} = 15\text{ V}$ and $T = 25\text{ }^\circ\text{C}$

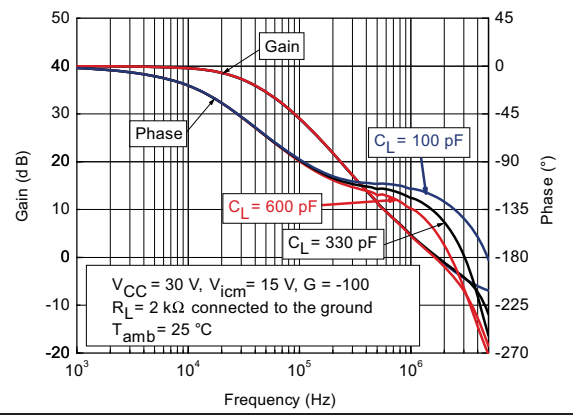

Figure 16. Frequency response for different capacitive loads at $V_{CC} = 6\text{ V}$, $V_{icm} = 3\text{ V}$ and $T = 25\text{ }^\circ\text{C}$

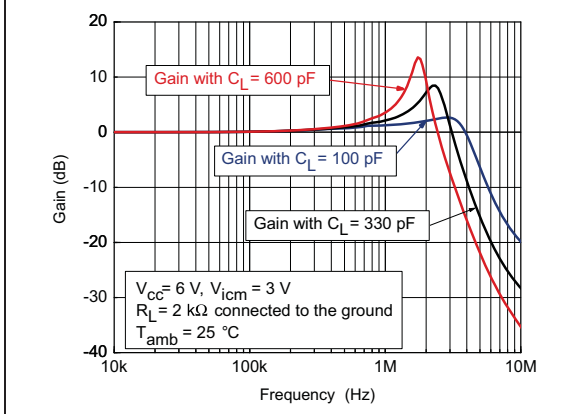

Figure 17. Frequency response for different capacitive loads at $V_{CC} = 10\text{ V}$, $V_{icm} = 5\text{ V}$ and $T = 25\text{ }^\circ\text{C}$

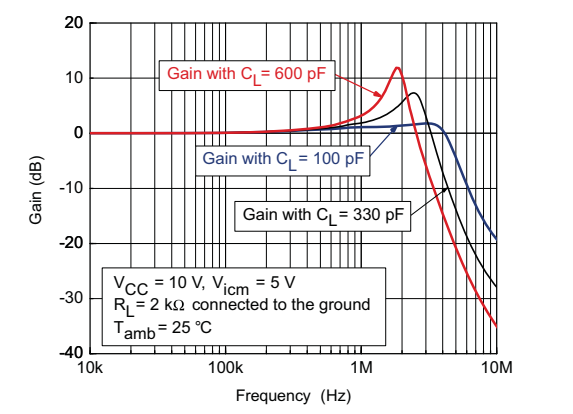

Figure 18. Frequency response for different capacitive loads at $V_{CC} = 30\text{ V}$, $V_{icm} = 15\text{ V}$ and $T = 25\text{ }^\circ\text{C}$

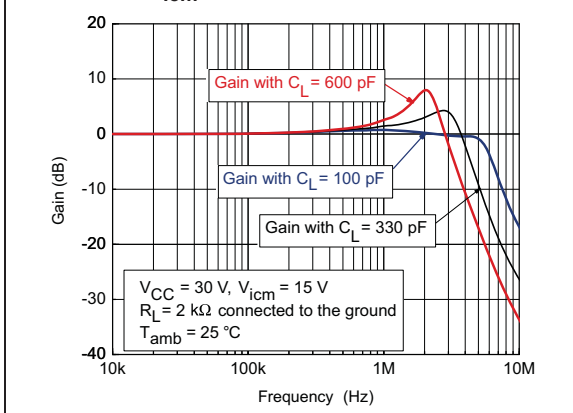
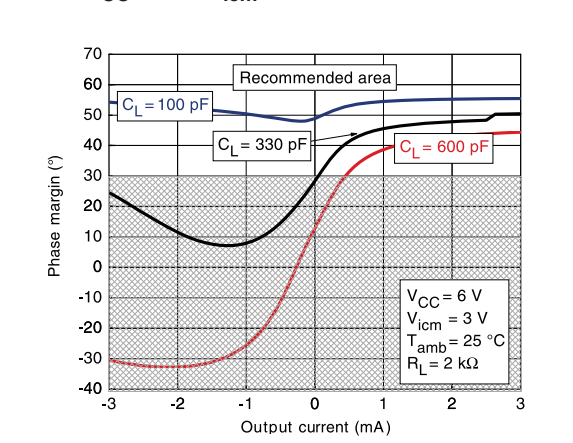
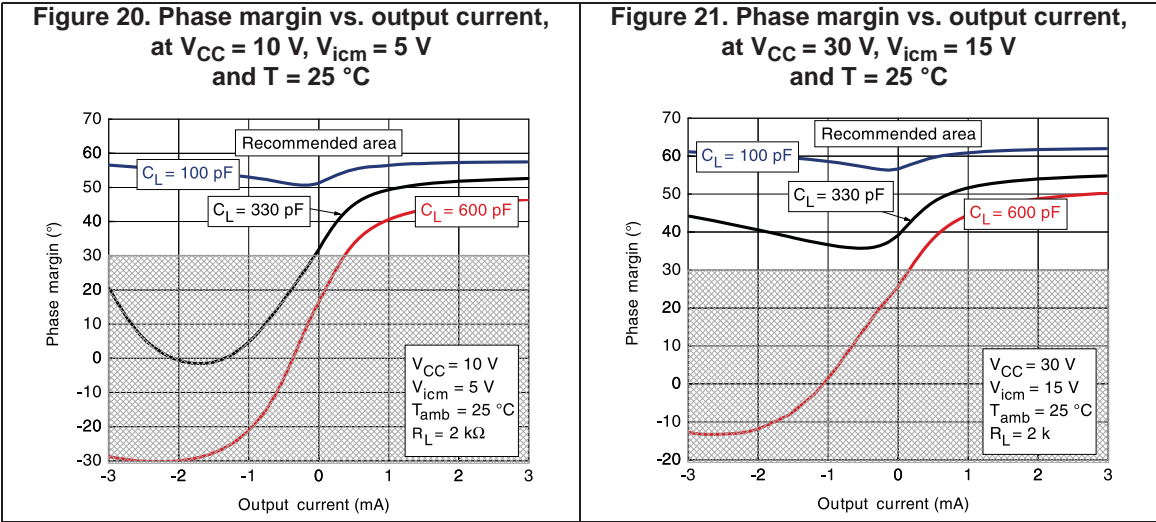

Figure 19. Phase margin vs. output current, at $V_{CC} = 6\text{ V}$, $V_{icm} = 3\text{ V}$ and $T = 25\text{ }^\circ\text{C}$





4 Macromodel

4.1 Important notes concerning this macromodel

- All models are a trade-off between accuracy and complexity (i.e. simulation time).
- Macromodels are not a substitute for breadboarding; rather, they confirm the validity of a design approach and help to select surrounding component values.
- A macromodel emulates the **nominal** performance of a **typical** device within **specified operating conditions** (for example, temperature, supply voltage). Thus the macromodel is often not as exhaustive as the datasheet, its purpose is to illustrate the main parameters of the product.

Data derived from macromodels used outside of the specified conditions (for example, V_{CC} , temperature) or even worse, outside of the device operating conditions (for example, V_{CC} , V_{icm}), are not reliable in any way.

[Section 4.2](#) provides the electrical characteristics resulting from the use of the RT512A, macromodel.

4.2 Electrical characteristics from macromodelization

Table 4. Electrical characteristics resulting from macromodel simulation at $V_{CC} = \pm 15\text{ V}$, $T_{amb} = 25\text{ °C}$ (unless otherwise specified)

| Symbol | Conditions | Value | Unit |
|---------------|--|-------------|------------------|
| V_{io} | | 0 | mV |
| A_{vd} | $R_L = 2\text{ k}\Omega$ | 100 | V/mV |
| I_{CC} | No load, per channel | 350 | μA |
| V_{icm} | | -13.4 to 14 | V |
| V_{OH} | $R_L = 2\text{ k}\Omega$ | +14 | |
| V_{OL} | $R_L = 2\text{ k}\Omega$ | -14 | |
| I_{sink} | $V_o = 0\text{ V}$ | 27.5 | mA |
| I_{source} | $V_o = 0\text{ V}$ | 27.5 | |
| GBP | $R_L = 2\text{ k}\Omega$, $C_L = 100\text{ pF}$ | 2.5 | MHz |
| SR | $R_L = 2\text{ k}\Omega$ | 1.4 | V/ μs |
| $\emptyset m$ | $R_L = 2\text{ k}\Omega$, $C_L = 100\text{ pF}$ | 55 | Degrees |

4.3 Macromodel code

```

** Standard Linear Ics Macromodels, 1993.
** CONNECTIONS :
* 1 INVERTING INPUT
* 2 NON-INVERTING INPUT
* 3 OUTPUT
* 4 POSITIVE POWER SUPPLY
* 5 NEGATIVE POWER SUPPLY

.SUBCKT TS512 1 3 2 4 5
*****
.MODEL MDTH D IS=1E-8 KF=6.565195E-17 CJO=10F
* INPUT STAGE
CIP 2 5 1.000000E-12
CIN 1 5 1.000000E-12
EIP 10 5 2 5 1
EIN 16 5 1 5 1
RIP 10 11 2.600000E+01
RIN 15 16 2.600000E+01
RIS 11 15 1.061852E+02
DIP 11 12 MDTH 400E-12
DIN 15 14 MDTH 400E-12
VOFP 12 13 DC 0
VOFN 13 14 DC 0
IPOL 13 5 1.000000E-05
CPS 11 15 12.47E-10
DINN 17 13 MDTH 400E-12
VIN 17 5 1.500000e+00
DINR 15 18 MDTH 400E-12
VIP 4 18 1.500000E+00
FCP 4 5 VOFP 3.400000E+01
FCN 5 4 VOFN 3.400000E+01
FIBP 2 5 VOFN 1.000000E-02
FIEN 5 1 VOFP 1.000000E-02
* AMPLIFYING STAGE
FIP 5 19 VOFP 9.000000E+02
FIN 5 19 VOFN 9.000000E+02
RG1 19 5 1.727221E+06
RG2 19 4 1.727221E+06
CC 19 5 6.000000E-09
DOPM 19 22 MDTH 400E-12
DONM 21 19 MDTH 400E-12
HOPM 22 28 VOUT 6.521739E+03
VIPM 28 4 1.500000E+02

```

```
HONM 21 27 VOUT 6.521739E+03
VINM 5 27 1.500000E+02
GCOMP 5 4 4 5 6.485084E-04
RPM1 5 80 1E+06
RPM2 4 80 1E+06
GAVPH 5 82 19 80 2.59E-03
RAVPHGH 82 4 771
RAVPHGB 82 5 771
RAVPHDH 82 83 1000
RAVPHDB 82 84 1000
CAVPHH 4 83 0.331E-09
CAVPHB 5 84 0.331E-09
EOUT 26 23 82 5 1
VOUT 23 5 0
ROUT 26 3 6.498455E+01
COUT 3 5 1.000000E-12
DOP 19 25 MDTH 400E-12
VOP 4 25 1.742230E+00
DON 24 19 MDTH 400E-12
VON 24 5 1.742230E+00
.ENDS
```

5 Package information

In order to meet environmental requirements, ST offers these devices in different grades of ECOPACK[®] packages, depending on their level of environmental compliance. ECOPACK specifications, grade definitions and product status are available at: www.st.com. ECOPACK is an ST trademark.

5.1 SO8 package information

Figure 22. SO8 package mechanical drawing

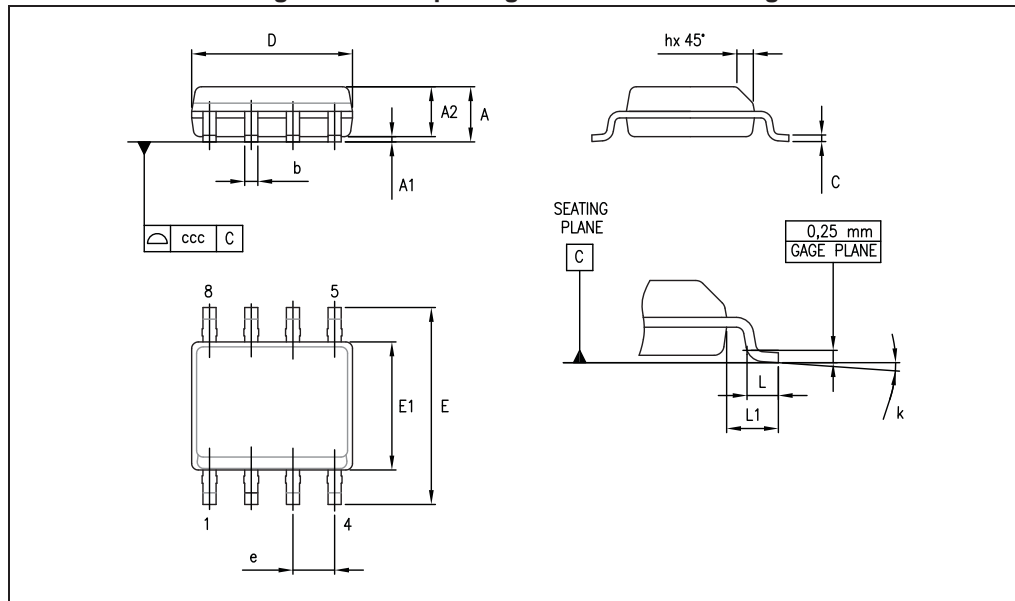

Table 5. SO8 package mechanical data

| Symbol | Dimensions | | | | | |
|--------|-------------|------|------|--------|-------|-------|
| | Millimeters | | | Inches | | |
| | Min. | Typ. | Max. | Min. | Typ. | Max. |
| A | | | 1.75 | | | 0.069 |
| A1 | 0.10 | | 0.25 | 0.004 | | 0.010 |
| A2 | 1.25 | | | 0.049 | | |
| b | 0.28 | | 0.48 | 0.011 | | 0.019 |
| c | 0.17 | | 0.23 | 0.007 | | 0.010 |
| D | 4.80 | 4.90 | 5.00 | 0.189 | 0.193 | 0.197 |
| E | 5.80 | 6.00 | 6.20 | 0.228 | 0.236 | 0.244 |
| E1 | 3.80 | 3.90 | 4.00 | 0.150 | 0.154 | 0.157 |
| e | | 1.27 | | | 0.050 | |
| h | 0.25 | | 0.50 | 0.010 | | 0.020 |
| L | 0.40 | | 1.27 | 0.016 | | 0.050 |
| L1 | | 1.04 | | | 0.040 | |
| k | 0 | | 8° | 1° | | 8° |
| ccc | | | 0.10 | | | 0.004 |

6 Ordering information

Table 6. Order codes

| Order code | Temperature range | Package | Packaging | Marking |
|------------|-------------------|---------|---------------|---------|
| RT512AIYDT | -40 °C to 125 °C | SO8 | Tape and reel | R512AY |

7 Revision history

Table 7. Document revision history

| Date | Revision | Changes |
|-------------|----------|-----------------|
| 08-Oct-2014 | 1 | Initial release |

IMPORTANT NOTICE – PLEASE READ CAREFULLY

STMicroelectronics NV and its subsidiaries (“ST”) reserve the right to make changes, corrections, enhancements, modifications, and improvements to ST products and/or to this document at any time without notice. Purchasers should obtain the latest relevant information on ST products before placing orders. ST products are sold pursuant to ST’s terms and conditions of sale in place at the time of order acknowledgement.

Purchasers are solely responsible for the choice, selection, and use of ST products and ST assumes no liability for application assistance or the design of Purchasers’ products.

No license, express or implied, to any intellectual property right is granted by ST herein.

Resale of ST products with provisions different from the information set forth herein shall void any warranty granted by ST for such product.

ST and the ST logo are trademarks of ST. All other product or service names are the property of their respective owners.

Information in this document supersedes and replaces information previously supplied in any prior versions of this document.

© 2014 STMicroelectronics – All rights reserved