

Features

Regulated Converter

- 150W DC/DC converter in Quarter Brick format
- 16:1 ultra wide input voltage range
- 4.242kVDC/1 minute reinforced insulation
- CE marked, CB report, UL marked
- Meets EN50155, EN45545-2 and EN50121-3-2
- Efficiency up to 90%
- -40°C to +105°C baseplate temperature range



RPA150Q-RUW

**150 Watt
Quarter
Brick Single
Output**



Description

The 150W quarter-brick RPA150Q series DC/DC converter is designed for railway rolling stock and high voltage battery applications. It has a 16:1 input voltage range to cover all input voltages from nominal 24VDC up to 110VDC in a single product (including EN50155 transients) and offers isolated and regulated 12V, 24V, or 48VDC outputs, all with +10%/-20% trim. The converter has a consistently high efficiency over the entire input voltage range and comes with a metal baseplate to permit a wide operating temperature range from -40°C to +85°C. The case is fitted with threaded inserts to allow secure mounting to the PCB or bulkhead for use in high shock and vibration environments. The converter is certified to and EN/UL62368-1, meets EN50155 + EN45545-2 and comes with a three-year warranty. The full suite of certifications, excellent efficiency, and ultra-wide input voltage range make this series particularly suitable for railway and industrial applications as well as 24 to 110V battery-powered systems and high temperature applications.



Selection Guide

Part Number	Input Voltage Range ⁽¹⁾ [VDC]	nom. Output Voltage [VDC]	Output Current max ⁽¹⁾ [A]	Efficiency typ. ⁽²⁾ [%]	Max. Capacitive Load [µF]
RPA150Q-11012SRUW/P	14.4-170	12	12.5	90	10000
RPA150Q-11024SRUW/P	14.4-170	24	6.25	89	5000
RPA150Q-11054SRUW/P	14.4-170	54	2.8	89	1000

Notes:

- Note1: Refer to "Input Voltage Range"
 Note2: Efficiency is tested by nominal Vin, full load and at 25°C



UL62368-1 certified
 CAN/CSA-C22.2 No. 62368-1 certified
 EN62368-1 certified
 EN55032 compliant
 EN55011 compliant
 meets EN50155, EN45545-2 and EN50121-3-2

Model Numbering

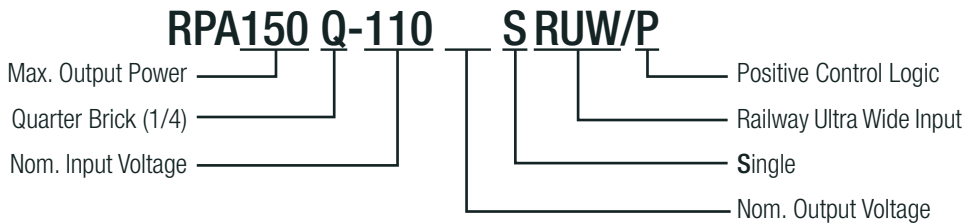

Ordering Examples

RPA150Q-11012SRUW/P = 9-60Vin, 12V Output, Single, Positive logic control
 RPA150Q-11054SRUW/P = 9-60Vin, 24V Output, Single, Positive logic control

Specifications (measured @Ta = 25°C, resistive load, nominal Vin and rated Iout unless otherwise noted)

BASIC CHARACTERISTICS

Parameter	Condition	Min.	Typ.	Max.
Input Voltage Range	refer to "Input Voltage Range" nom. Vin= 72VDC	14.4VDC	110VDC	170VDC
Under Voltage Lockout (UVLO)	DC-DC ON DC-DC OFF	12.2VDC 10.2VDC		13.8VDC 11.8VDC
Input Current	@ 14.4Vin, full load		12.5A	
Quiescent Current	@110Vin, no load		20mA	
Output Voltage Trimming ⁽³⁾	leave open if not used refer to "OUTPUT VOLTAGE TRIMMING" others 24Vout	-20%		+10% +18%
Minimum Load			0%	
Start-up time	12Vout		275ms	
	24Vout		300ms	
	54Vout		330ms	
Rise Time (10% to 90%)	12Vout		25ms	
	24Vout		50ms	
	54Vout		80ms	
ON/OFF CTRL	DC-DC ON DC-DC OFF	open or $2.5 < V_{CTRL} < 5VDC$ short or $-0.7 < V_{CTRL} < -0.8VDC$		
Input current of CTRL pin	110Vin, DC-DC OFF			1mA
Internal Operating Frequency			250kHz	
Output Ripple and Noise	20MHz BW, measured with a 100uF polymer and 4.7uF ceramic output cap			1.5% of Vin

Notes:

Note3: By trimming up, decrease output current to avoid exceeding rated output power.
By trimming down, do not exceed max. continuous output current

Input Voltage Range

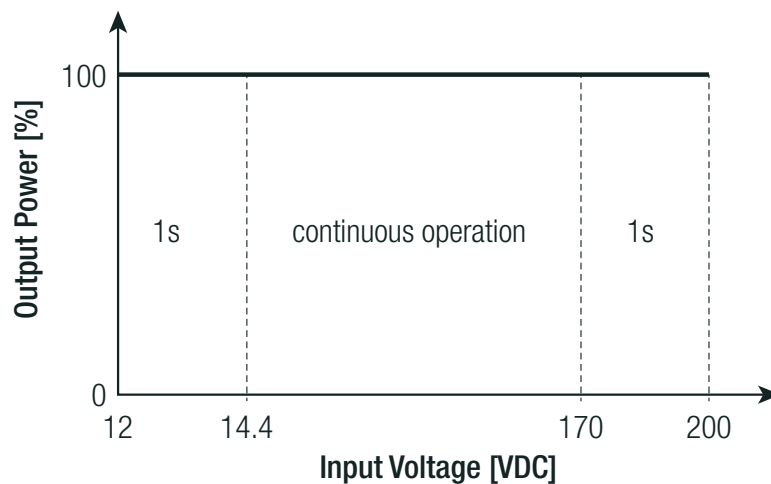

Continuous full power operation is rated between 14.4V and 170V, including full load start-up.

Once running, the converter will operate for short periods of time over an extended input voltage range down to 12V and up to 200V.

continued on next page

Specifications (measured @Ta = 25°C, resistive load, nominal Vin and rated Iout unless otherwise noted)

RPA150Q-11012SRUW/P

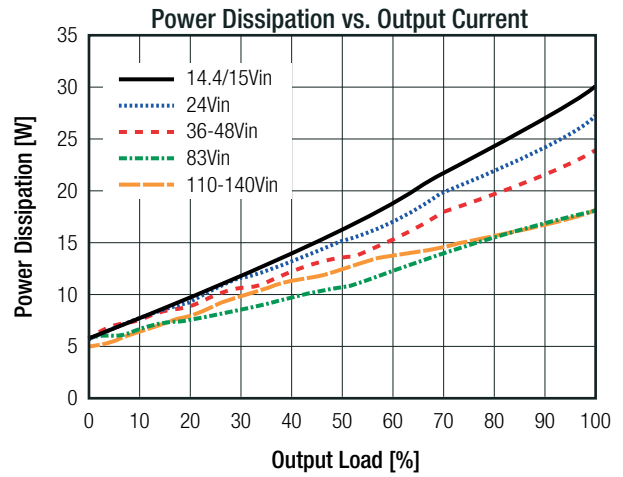
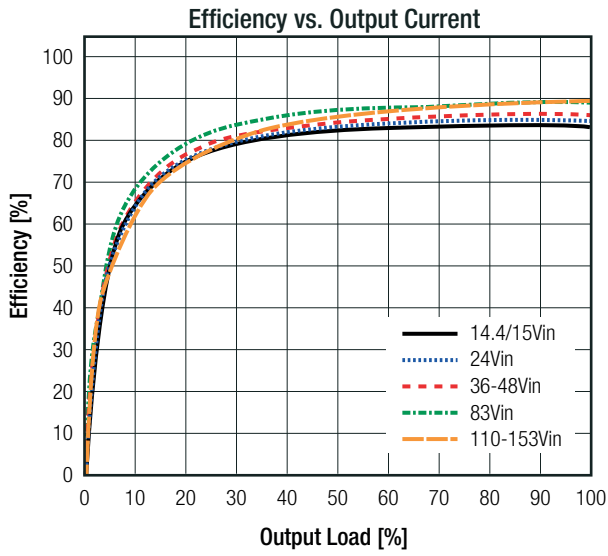

RPA150Q-11024SRUW/P

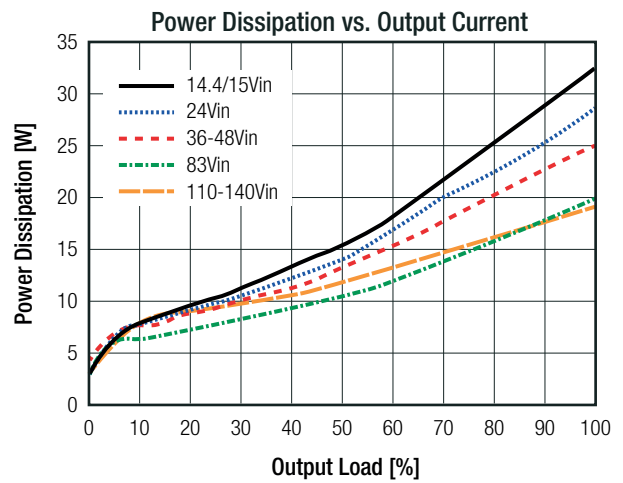
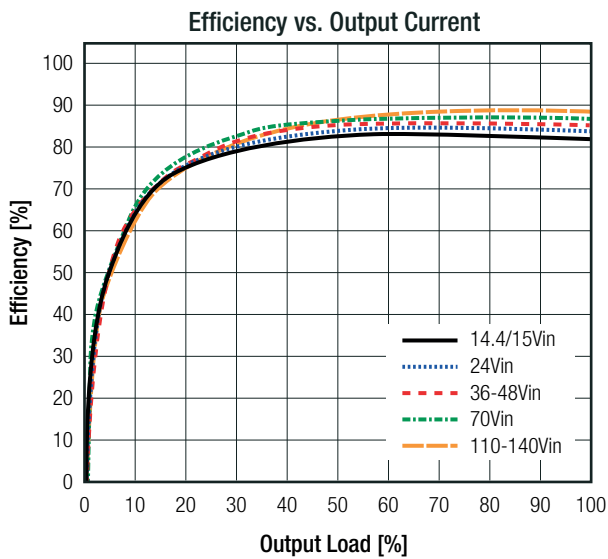

RPA150Q-11054SRUW/P

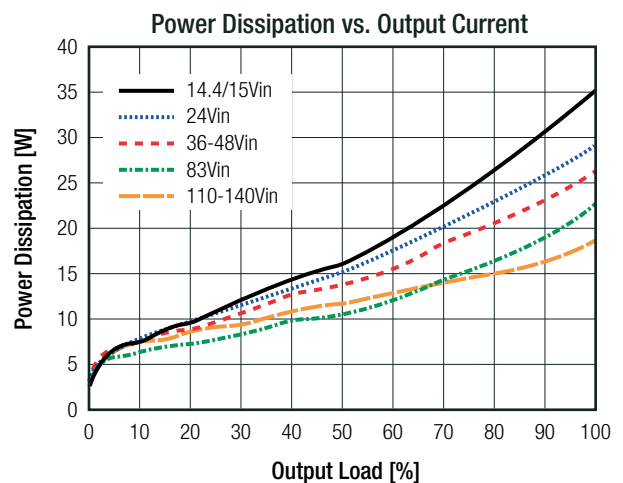
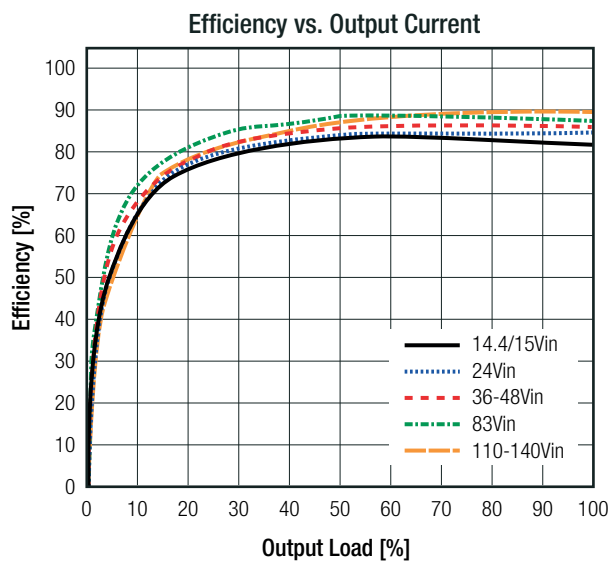

Specifications (measured @Ta = 25°C, resistive load, nominal Vin and rated Iout unless otherwise noted)

ON/OFF CTRL

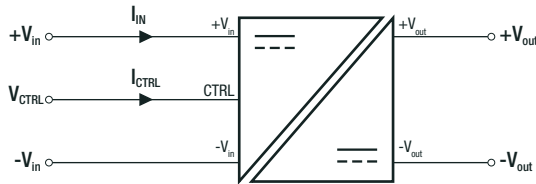

Positive Logic DC-DC ON
DC-DC OFF Open or 2.5VDC < V_{CTRL} < 5VDC
Short or -V_{IN} or -0.7VDC < V_{CTRL} < 0.8VDC

OUTPUT VOLTAGE TRIMMING

RPA150Q-RUW converters offer the feature of trimming the output voltage over a certain range around the nominal value by using external trim resistors. The values for trim resistors shown in trim tables below are according to standard E96 values; therefore, the specified voltage may slightly vary; they also can be calculated with below shown equation.

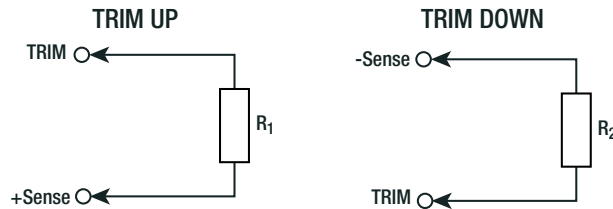

- V_{out_{nom}} = nominal output voltage [VDC]
- V_{out_{set}} = trimmed output voltage [VDC]
- ΔV_{out} = output voltage change [%]
- V_{ref} = reference voltage [VDC]
- R_{up} = trim up resistor [Ω]
- R_{down} = trim down resistor [Ω]
- R₁ - R₃ = internal resistors [Ω]

Calculation:

$$R_{up} = \left[\frac{R_2}{\Delta V_{out}} \right] - R_3$$

$$R_{down} = \left[\frac{V_{ref}}{\Delta V_{out}} \right] - R_1$$

V _{out_{nom}}	R ₁	R ₂	R ₃	V _{ref}
12VDC	10k22	45k	40k	5.11VDC
24VDC		95k	90k	
54VDC		220k	215k	

Practical Example RPA150E-12SEW trim up +10%

$$R_{up} = \left[\frac{45k}{0.1} \right] + 40k = 490k\Omega$$

R_{up} according to E96 ≈ **487kΩ**

Practical Example RPA200H-12SRUW trim down -10%

$$R_{down} = \left[\frac{5.11}{0.1} \right] - 10k22 = 40k88\Omega$$

R_{down} according to E96 ≈ **41k2Ω**

RPA150Q-11012SRUW/P

Trim up	1	2	3	4	5	6	7	8	9	10	[%]
V _{out_{set}} =	12.12	12.24	12.36	12.48	12.6	12.72	12.84	12.96	13.08	13.2	[VDC]
R _{up} =	4M53	2M32	1M54	1M18	931k	787k	681k	604k	536k	487k	[Ω]

Trim down	-1	-2	-3	-4	-5	-6	-7	-8	-9	-10	[%]
V _{out_{set}} =	11.88	11.76	11.64	11.52	11.40	11.28	11.16	11.04	10.92	10.8	[VDC]
R _{DOWN} =	499k	243k	162k	118k	90k9	75k	63k4	53k6	46k4	41k2	[Ω]

Trim down	-11	-12	-13	-14	-15	-16	-17	-18	-19	-20	[%]
V _{out_{set}} =	10.68	10.56	10.44	10.32	10.2	10.08	9.96	9.84	9.72	9.6	[VDC]
R _{DOWN} =	36k5	32k4	29k4	26k1	23k7	21k5	20k	18k2	16k5	15k4	[Ω]

continued on next page

Specifications (measured @Ta = 25°C, resistive load, nominal Vin and rated Iout unless otherwise noted)

RPA150Q-11024SRUW/P

Trim up	1	2	3	4	5	6	7	8	9	10	[%]
Vout _{set} =	24.24	24.48	24.72	24.96	25.2	25.44	25.68	25.92	26.16	26.4	[VDC]
R _{UP} =	9M53	4M87	3M24	2M49	2M	1M69	1M43	1M27	1M15	1M05	[Ω]
Trim up	11	12	13	14	15	16	17	18	[%]		
Vout _{set} =	26.64	26.88	27.12	27.36	27.6	27.84	28.08	28.32	[VDC]		
R _{UP} =	953k	887k	825k	768k	715k	681k	649k	619k	[Ω]		
Trim down	-1	-2	-3	-4	-5	-6	-7	-8	-9	-10	[%]
Vout _{set} =	23.76	23.52	23.28	23.04	22.8	22.56	22.32	22.08	21.84	21.6	[VDC]
R _{DOWN} =	499k	243k	162k	118k	90k9	75k	63k4	53k6	46k4	41k2	[Ω]
Trim down	-11	-12	-13	-14	-15	-16	-17	-18	-19	-20	[%]
Vout _{set} =	21.36	21.12	20.88	20.64	20.4	20.16	19.92	19.68	9.72	9.6	[VDC]
R _{DOWN} =	36k5	32k4	29k4	26k1	23k7	21k5	20k	18k2	16k5	15k4	[Ω]

RPA150Q-11054SRUW/P

Trim up	1	2	3	4	5	6	7	8	9	10	[%]
Vout _{set} =	54.54	55.08	55.62	56.16	56.7	57.24	57.78	58.32	58.86	59.4	[VDC]
R _{UP} =	22M1	11M3	7M5	5M76	4M64	3M92	3M32	2M94	2M67	2M43	[Ω]
Trim down	-1	-2	-3	-4	-5	-6	-7	-8	-9	-10	[%]
Vout _{set} =	53.46	52.92	52.38	51.84	51.3	50.76	50.22	49.68	49.14	48.6	[VDC]
R _{DOWN} =	499k	243k	162k	118k	90k9	75k	63k4	53k6	46k4	41k2	[Ω]
Trim down	-11	-12	-13	-14	-15	-16	-17	-18	-19	-20	[%]
Vout _{set} =	48.06	47.52	46.98	46.44	45.9	45.36	44.82	44.28	43.74	43.2	[VDC]
R _{DOWN} =	36k5	32k4	29k4	26k1	23k7	21k5	20k	18k2	16k5	15k4	[Ω]

REGULATION

Parameter	Condition	Value
Output Accuracy		±1.0% max.
Line Regulation	low line to high line, full load	±0.2% max.
Load Regulation		0.2% max.
Transient Response ⁽⁴⁾	50%~75% Load step, 0.1A/us recovery time	5.0% typ. 1ms max.

Notes:

Note4: Measured with a 100uF polymer + 4.7uF ceramic output cap

PROTECTIONS

Parameter	Type	Value	
Over Voltage Protection (OVP)	12Vout	14-17VDC, hiccup mode	
	24Vout	30-36VDC, hiccup mode	
	54Vout	60-75VDC, hiccup mode	
Over Current Protection (OCP)		110%-190% of rated Iout, hiccup mode	
Over Temperature Protection (OTP)	NTC temperature restart hysteresis	+125°C +15°C	
Isolation Voltage ⁽⁵⁾	tested for 1 minute	I/P to O/P	4.242kVDC
		I/P or O/P to baseplate	2.25kVDC

continued on next page

Specifications (measured @Ta = 25°C, resistive load, nominal Vin and rated Iout unless otherwise noted)

Parameter	Type	Value
Isolation Resistance	Viso= 500VDC	100MΩ min.
Insulation Grade		reinforced

Notes:

Note5: For repeat Hi-Pot testing, reduce the time and/or the test voltage

Note6: Refer to local safety regulations if input over-current protection is also required. Recommended fuse: T25A slow blow type

ENVIRONMENTAL

Parameter	Condition	Value
Operating Ambient Temperature Range	refer to <i>“Thermal Derating with convection cooling”</i>	-40°C to +85°C
Operating Baseplate Temperature Range	refer to <i>“Thermal Derating with conduction cooling”</i>	-40°C to +105°C
Temperature Coefficient		0.04%/K
Operating Altitude		5500m
Operating Humidity		95% RH
Pollution Degree		PD2
Shock		according to EN61373
Vibration		according to EN61373
MTBF	V _{IN} = 72VDC, 80% load, +25°C	597 x 10 ³ hours

Thermal Derating with conduction cooling

RPA150Q-11012SRUW/P

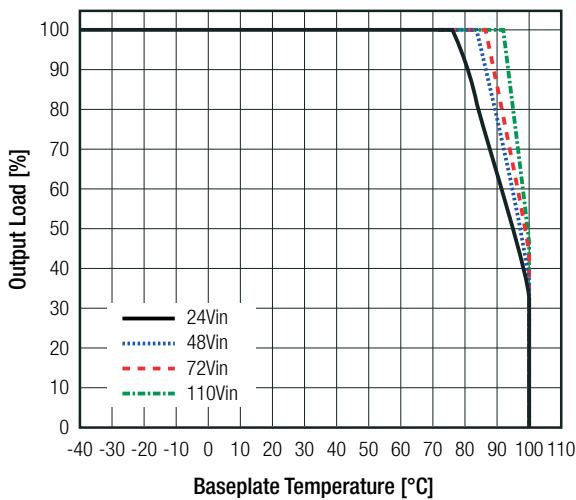

RPA150Q-11024SRUW/P

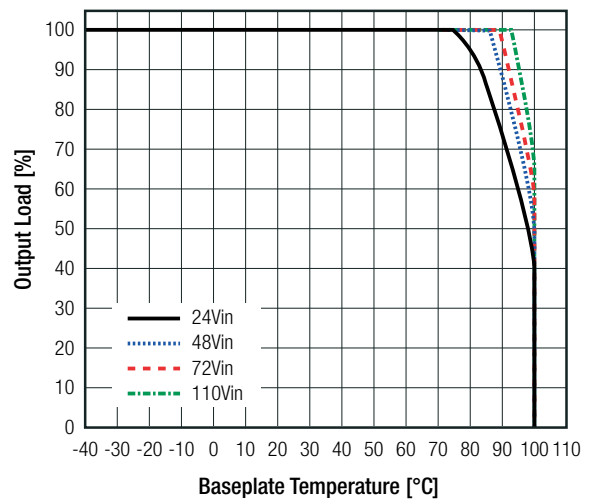

RPA150Q-11054SRUW/P

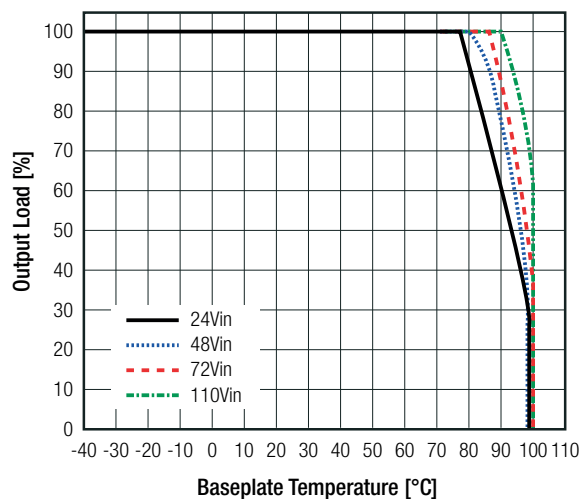

continued on next page

Specifications (measured @Ta = 25°C, resistive load, nominal Vin and rated Iout unless otherwise noted)

Thermal Derating with convection cooling (PCB/ without heat-sink)

Test PCB: Eurocard 160x100mm 105µm copper, double layer; VIN= 110VDC

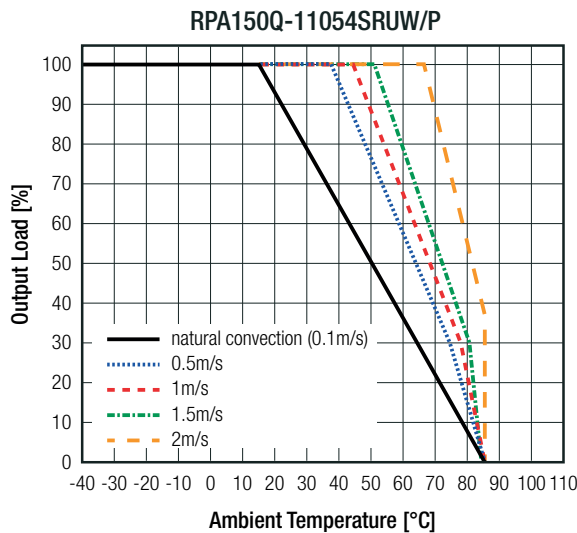
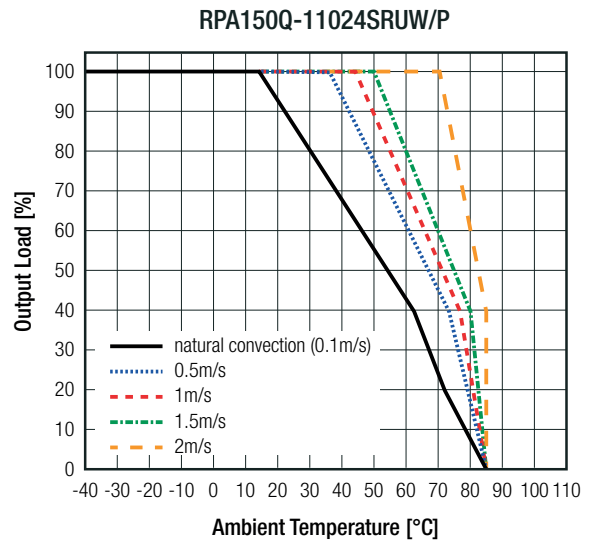
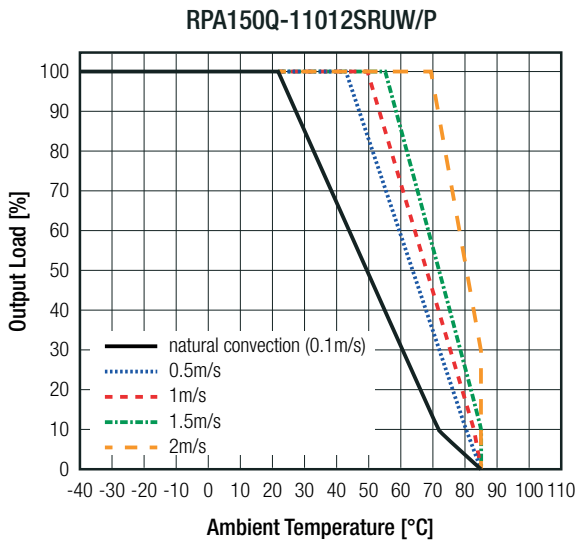

SAFETY AND CERTIFICATIONS		
Certificate Type (Safety)	Report Number	Standard
Audio/Video, information and communication technology equipment - Part1: Safety requirements	E224736-A6010-UL E224736-A6012-UL E224736-A6013-UL	UL62368-1:2018 CAN/CSA-C22.2 No. 62368-1:2018
Audio/Video, information and communication technology equipment - Part1: Safety requirements		EN62368-1:2014 + A11:2017
RoHS2		RoHS 2011/65/EU + AM2015/863
EMC Compliance		
Condition	Standard	
Electromagnetic compatibility of multimedia equipment - Emission requirements	with external components	EN55032:2015, Class A
Industrial, scientific and medical equipment – Radio-frequency disturbance characteristics – Limits and methods of measurement		EN55011
ESD Electrostatic discharge immunity test	Air ±8kV, Contact ±6kV	IEC61000-4-2:2008, Criteria A EN61000-4-2:2009, Criteria A
Fast Transient and Burst Immunity	DC Power Port: ±2kV	IEC/EN61000-4-4:2012, Criteria A
Surge Immunity	DC Power Port: DM ±1kV; CM ±2kV	IEC/EN61000-4-5:2014, Criteria A

Specifications (measured @Ta = 25°C, resistive load, nominal Vin and rated Iout unless otherwise noted)

DIMENSIONS and PHYSICAL CHARACTERISTICS

Parameter	Type	Value
Material	case potting baseplate	plastic, UL94 V-0 silicone, UL94 V-0 aluminum
Package Dimensions (LxWxH)		60.6 x 39.0 x 12.7mm
Package Weight		88g typ.

Dimension Drawing (mm)

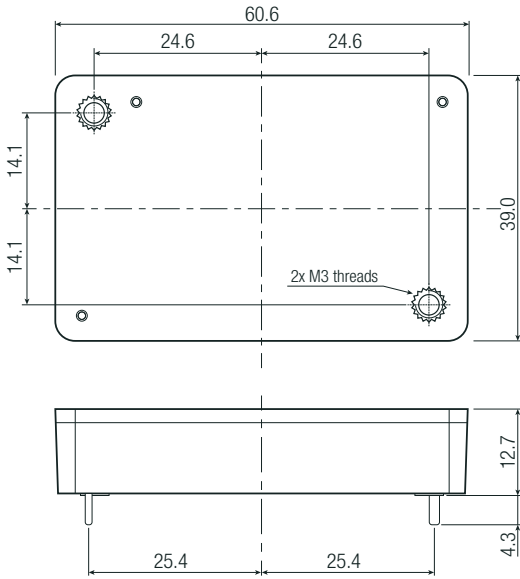
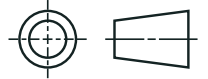

Pinning Information

Pin #	Function
1	-Vin
2	CTRL
3	+Vin
4	+Vout
5	+Sense
6	Trim
7	-Sense
8	-Vout

tc= case temperature measuring point
Tolerance: x.x= ±0.5mm
x.xx= ±0.25mm

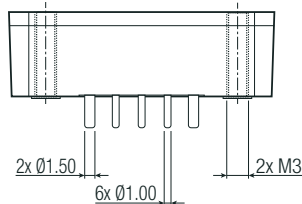

Recommended Footprint Details

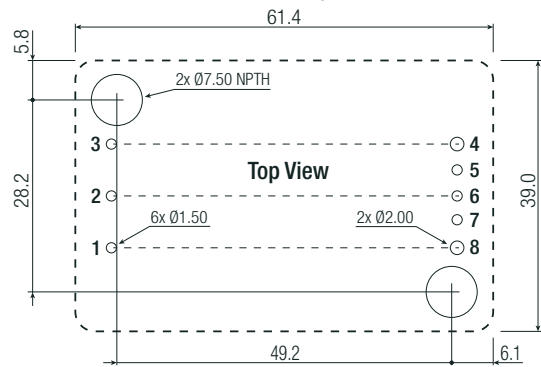
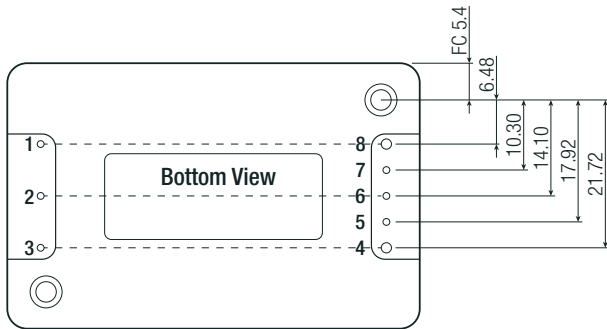

PACKAGING INFORMATION

Parameter	Type	Value
Packaging Dimensions (LxWxH)	cardboard box	221.0 x 128.0 x 33.0mm
Packaging Quantity		4pcs
Storage Temperature Range		-40°C to +125°C
Storage Humidity	non-condensing	95% RH

The product information and specifications may be subject to changes even without prior written notice. The product has been designed for various applications; its suitability lies in the responsibility of each customer. The products are not authorized for use in safety-critical applications without RECOM's explicit written consent. A safety-critical application is an application where a failure may reasonably be expected to endanger or cause loss of life, inflict bodily harm or damage property. The applicant shall indemnify and hold harmless RECOM, its affiliated companies and its representatives against any damage claims in connection with the unauthorized use of RECOM products in such safety-critical applications.