



2016

# RF & Wireless

## Semiconductors



[www.cel.com](http://www.cel.com)

Product Selection Guide

# About CEL

CEL (California Eastern Laboratories) is an engineering, sales and marketing company focused on RF Semiconductors, Optical Semiconductors and Wireless Connectivity Solutions.

CEL serves designers, OEMs and contract manufacturers in various RF, Wireless and Optical markets. With over 55 years experience in high frequency design, customer support and fulfillment, CEL is ideally positioned to provide its customers with a stable supply of products to meet their specific needs.

CEL maintains extensive inventories and provides engineering and applications assistance at its technical centers in Santa Clara, CA., Buffalo Grove, IL and Lafayette, CO. The company supports customers through sales offices, sales representatives and distributors in numerous locations.



## CEL Headquarters

4590 Patrick Henry Drive  
Santa Clara, CA 95054  
Tel: (408) 919-2500

[www.cel.com](http://www.cel.com)

## PRODUCTS by APPLICATION

<b>Front End Components Up to 6GHz Applications</b>	2
<b>LNAs for 2 to 8GHz Applications</b>	3
<b>LNBS for 12 to 20GHz Applications</b>	3

## PRODUCT SPECIFICATIONS

<b>RF Switch ICs</b>	
SPDTs (Single Pole Double Throw)	4
SP3Ts (Single Pole Triple Throw)	5
DPDTs (Double Pole Double Throw)	5
<b>GaAs FETs</b>	
Low Noise GaAs FETs, 1 to 20GHz	5
<b>Silicon MOSFET Devices</b>	
RF Power LD-MOSFETs	6
MOSFET for Microphone Impedance Conversion	6
<b>Silicon Bipolar Transistors</b>	
Single Transistors	7
Twin Transistors	8
<b>Silicon RFICs</b>	
3V Silicon MMIC Amplifiers	8
5V Silicon MMIC Amplifiers	9
Frequency Upconverters	9
Frequency Downconverters	9
<b>Package Dimensions</b>	10

# Front End Components Up to 6 GHz Applications

Wi-Fi • Bluetooth • ZigBee • Automated Meter Reading • Mesh & Home Area Networks • ISM Band Applications

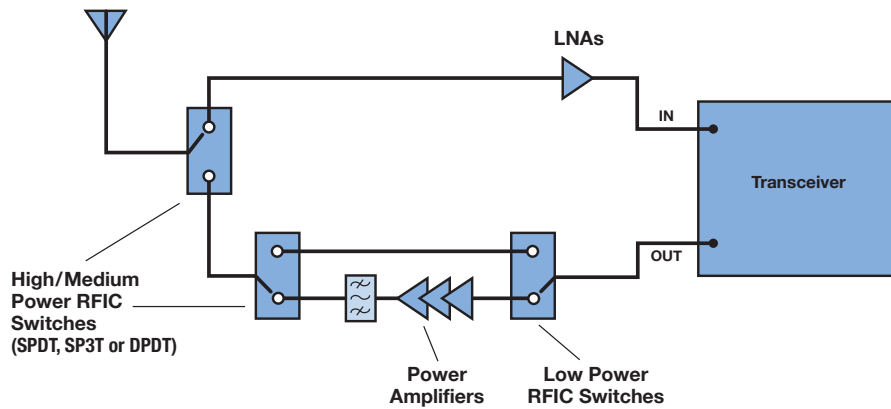

RFIC Switches <i>(additional P/Ns available, see page 4)</i>		450 MHz	915 MHz	2.4 GHz	6 GHz
<b>NEW</b> CG2163X3	SPDT, High Power and High Isolation for WLAN			✓	✓
<b>NEW</b> CG2176X3	SPDT, High Power & High Isolation Absorptive Dual Band Switch			✓	✓
<b>NEW</b> CG2179M2	SPDT, Low cost, Insertion Loss: 0.45dB @2.5GHz	✓	✓	✓	
<b>NEW</b> CG2185X2	SPDT, for Dual Band WLAN, Insertion Loss: 0.4dB @ 6GHz, small package			✓	✓
<b>NEW</b> CG2214M6	SPDT, Insertion Loss: 0.35GHz @ 2.5GHz, Isolation = 25 @ 2.5GHz	✓	✓	✓	
<b>NEW</b> CG2415M6	SPDT, Dual Band High Power for WLAN		✓	✓	✓
<b>NEW</b> CG2430X1	SP3T, Insertion Loss: 0.60dB @ 6GHz, Isolation = 25dB @ 6GHz	✓	✓	✓	✓
UPG2162T5N	DPDT, Insertion Loss: 0.85 dB @ 6GHz, 27 dB Isolation @ 6GHz			✓	✓
UPG2163T5N	SPDT, 0.5-8GHz, Insertion Loss: 0.4dB @ 2.4 GHz, 0.5dB @ 6GHz		✓	✓	✓
UPG2164T5N	DPDT, Diversity/Transfer Switch (two selectable RF paths on)			✓	✓
UPG2176T5N	SPDT, 2.4 – 6GHz, Insertion Loss: 0.5dB @ 2.4 GHz, internal terminations			✓	✓
UPG2406TK	SPDT, 1.8 or 2.7V control voltage, 0.50 dB Insertion Loss @ 2.5GHz	✓	✓	✓	
UPG2408TB / TK	SPDT, 3V, 0.50dB Insertion Loss, SOT-363 and SMD Packages	✓	✓	✓	
UPG2409TB / T6X	SPDT, High Power wide bandwidth, SOT-363 / TSON packages	✓	✓	✓	T6X only
UPG2415TK / T6X	SPDT, for Dual Band WLAN, low insertion loss for Access Point applications	T6X only	✓	✓	✓
UPG2422TK	SPDT,for Dual Band WLAN, 1.8-5.3V control voltage range	✓	✓	✓	✓
Power Amplifier Transistors <i>(additional P/Ns available, see page 7 &amp; 9)</i>		450 MHz	915 MHz	2.4 GHz	6 GHz
NE5550234	+33dBm, 2W, 7.5V LDMOS FET	✓	✓		
NE5550979A	+39.5dBm, 9W, 7.5V LD MOSFET	✓	✓		
NE664M04	+26dBm, 3.6V Silicon Discrete	✓	✓	✓	
NE677M04	+15dBm, 3.0 V Silicon Discrete	✓	✓	✓	
NE678M04	+18dBm, 3.0 V Silicon Discrete	✓	✓	✓	
Low Noise Amplifier Transistors		450 MHz	915 MHz	2.4 GHz	6 GHz
NE662M04	Silicon Discrete, NF = 1.1, Ga = 16.0, OIP3 = +22dBm @ 2GHz	✓	✓	✓	
NE3508M04	GaAs FET, NF = 0.45, Ga = 14.0, OIP3 = +31dBm @ 2GHz			✓	✓
NE3509M04	GaAs FET, NF = 0.40, Ga = 17.5, OIP3 = +22dBm @ 2GHz			✓	✓

# LNAs for 2 to 8GHz Applications

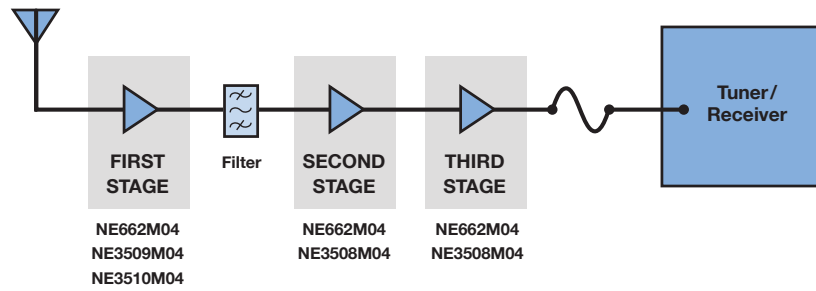

Part Number	Description	NF (dB)	Gain (dB)	P1dB (dBm)	Package
NE662M04	Silicon Bipolar Transistor	1.1 @ 2.0GHz	16.0 @ 2.0GHz	+11.0	M04
NE3508M04	GaAs HJ-FET	0.45 @ 2.0GHz	14.0 @ 2.0GHz	+18.0	M04
NE3509M04	GaAs HJ-FET	0.40 @ 2.0GHz	17.5 @ 2.0GHz	+14.0	M04
NE3510M04	GaAs HJ-FET	0.35 @ 2.0GHz	19.0 @ 2.0GHz	+12.0	M04

(See data tables for additional specifications)

# LNAs for 12 to 20GHz Applications

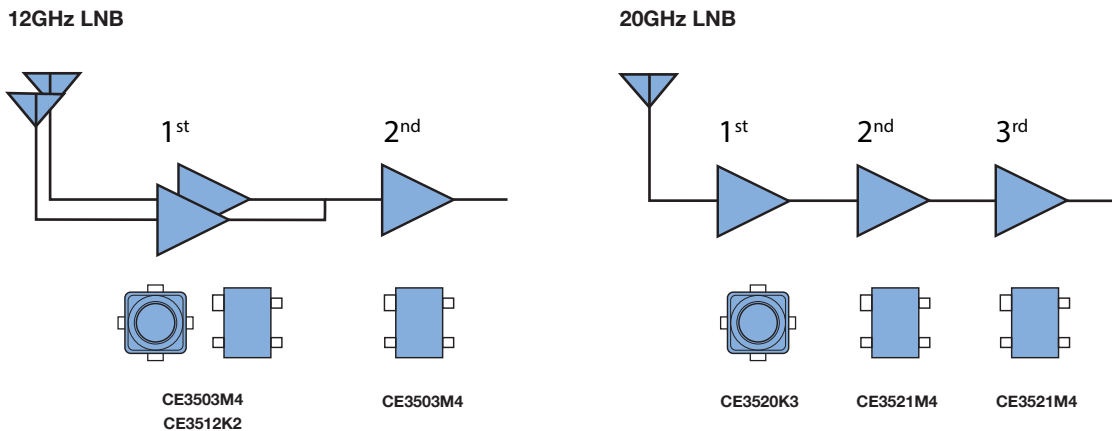

	Part Number	NF TYP (dB)	Ga TYP (dB)	Conditions		
				Freq. (GHz)	V <sub>DS</sub> (V)	I <sub>D</sub> (mA)
Ku Band 12GHz	CE3503M4	0.45	13.2	12	2	10
	CE3512K2	0.30	13.7	12	2	10
K Band 20GHz	CE3520K3	0.55	13.8	20	2	10
	CE3521M4	0.70	11.9	20	2	10

(See data tables for additional specifications)

# RF Switch ICs

## SPDTs (Single Pole Double Throw)

Part Number	TYPICAL ELECTRICAL CHARACTERISTICS (T <sub>A</sub> = 25°C)						Pkg. Code <sup>1</sup>	Description
	Frequency (GHz, max)	Control Voltages (V)	Insertion Loss (dB)	Isolation (dB)	Input Power @ 0.1 dB compression point (dBm)	Input Power @ 1.0 dB compression point (dBm)		
<b>NEW</b> CG2163X3	6.0	1.8, 3.0, 5.0	0.40 @ 2.5GHz 0.50 @ 6GHz	40 @ 2.5GHz 31 @ 6GHz	-	+33 @ 2.5GHz +32 @ 6GHz	X3	Highest Isolation, great 2.4 and 6GHz performance
<b>NEW</b> CG2176X3	5.85	1.8, 3.0, 5.0	0.45 @ 2.5GHz 0.50 @ 3.8GHz 0.55 @ 5.85GHz	30 @ 2.5GHz 25 @ 3.8GHz 22 @ 5.85GHz	-	-	X3	<b>Absorptive</b> , Highest Power Switch
<b>NEW</b> CG2179M2	3.0	1.8, 3.0, 5.0	0.45 @ 2.5GHz	26 @ 2.5GHz	+30 @ 3GHz	-	M2	Low Cost General Purpose SPDT
<b>NEW</b> CG2185X2	6.0	1.8, 3.0, 5.0	0.35 @ 2.5GHz 0.40 @ 6GHz	28 @ 2.5GHz 26 @ 6GHz	+29 @ 2.5GHz +29 @ 6GHz	+32 @ 2.5GHz +32 @ 6GHz	X2	SPDT specified to 6GHz with a very small & thin package
<b>NEW</b> CG2214M6	3.0	1.8, 3.0, 5.0	0.35 @ 2.5GHz	25 @ 2.5GHz	+30 @ 3GHz	-	M6	General Purpose SPDT
<b>NEW</b> CG2415M6	6.0	1.8, 3.0, 5.3	0.35 @ 2.5GHz 0.45 @ 6GHz	32 @ 2.5GHz 26 @ 6GHz	+31 @ 2.5GHz +31 @ 6GHz	-	M6	High Power SPDT for WLAN Access Point, small size package
UPD5713TK	2.5	1.8, 2.8, 3.6	0.95 @ 2.5GHz	22.5 @ 2.5GHz	+17 @ 1GHz	+21 @ 1GHz	TK	Single Control (1.8-V <sub>DD</sub> ), small size package, CMOS
UPG2009TB	3.0	2.7, 2.8, 3.0	0.40 @ 2.5GHz	25 @ 2.5GHz	+34 @ 1GHz	-	TB	High power handling, low insertion loss, high isolation
UPG2030TK	3.0	2.7, 2.8, 5.4	0.35 @ 2.5GHz	24 @ 2.5GHz	+27 @ 2.5GHz	-	TK	Medium power, small size package
UPG2155TB	2.5	2.4, 2.6, 5.0	0.45 @ 2.5GHz	17 @ 2.5GHz	+37.5 @ 1.8GHz	-	TB	High power handling, low harmonics, high power switch
UPG2163T5N	8.0	2.8, 3.0, 5.0	0.40 @ 2.5GHz 0.50 @ 6GHz 0.90 @ 8GHz	38 @ 2.5GHz 30 @ 6GHz 23 @ 8GHz	-	+31 @ 2.5GHz +29 @ 6GHz	T5N	High isolation, great 2.4 and 6GHz performance
UPG2176T5N	6.0	2.5, 3.0, 5.0	0.45 @ 2.5GHz 0.70 @ 6GHz	27 @ 2.5GHz 21 @ 6GHz	-	+37 @ 2.5GHz +37 @ 2.85GHz	T5N	<b>Absorptive</b> , high power and high linearity to 6GHz
UPG2214TB	3.0	1.8, 3.0, 5.3	0.35 @ 2.5GHz	26 @ 2.5GHz	+23 @ 2.5GHz	+27 @ 2.5GHz	TB	Low insertion loss, high isolation, medium power, 1.8V-5.3V.
UPG2214TK	3.0	1.8, 3.0, 5.3	0.35 @ 2.5GHz	26 @ 2.5GHz	+23 @ 2.5GHz	+27 @ 2.5GHz	TK	Small size package, low insertion loss, high isolation, medium power, 1.8V-5.3V.
UPG2406TB	3.0	1.8, 2.7, 5.3	0.47 @ 2.5GHz	17 @ 2.5GHz	+29 @ 2.5GHz	+30.5 @ 2.5GHz	TB	General Purpose SPDT
UPG2406TK	3.0	1.8, 2.7, 5.3	0.47 @ 2.5GHz	17 @ 2.5GHz	+29 @ 2.5GHz	+30.5 @ 2.5GHz	TK	Small size package, cost effective medium power, 1.8V-5.3V
UPG2408TB	3.0	2.5, 3.0, 5.3	0.50 @ 2.5GHz	18 @ 2.5GHz	+29 @ 2.5GHz	-	TB	Low cost medium power for UHF-3GHz
UPG2408TK	3.0	2.5, 3.0, 5.3	0.50 @ 2.5GHz	18 @ 2GHz	+29 @ 2.5GHz	-	TK	Small size package, cost effective medium power
UPG2409TB	3.8	2.7, 3.0, 5.3	0.45 @ 2.5GHz	26 @ 2.5GHz	+33.5 @ 2.5GHz	+35 @ 2.5GHz	TB	High power SPDT, for Access Points to 3.8GHz
UPG2409T6X	6.0	2.7, 3.0, 3.3	0.45 @ 2.5GHz 0.65 @ 6GHz	30 @ 2.5GHz 27 @ 6GHz	+34 @ 2.5GHz +34 @ 6GHz	+36 @ 2.5GHz +36 @ 6GHz	T6X	High power, for Access Points to 6GHz, 1.5mm QFN package
UPG2415TK	6.0	2.7, 3.0, 5.3	0.45 @ 2.5GHz 0.65 @ 6GHz	28 @ 2.5GHz 26 @ 6GHz	+31 @ 2.5GHz +31 @ 6GHz	+34 @ 2.5GHz +34 @ 6GHz	TK	High power handling for Access Points to 6GHz, small size package
UPG2415T6X	6.0	2.7, 3.0, 3.3	0.45 @ 2.5GHz 0.55 @ 6GHz	28 @ 2.5GHz 26 @ 6GHz	+31 @ 2.5GHz +31 @ 6GHz	+35 @ 2.5GHz +35 @ 6GHz	T6X	High power handling for Access Points to 6GHz, 1.5mm QFN package
UPG2422TK	6.0	1.8, 3.0, 5.3	0.35 @ 2.5GHz 0.55 @ 6GHz	28 @ 2.5GHz 24 @ 6GHz	+28 @ 2.5GHz +28 @ 6GHz	+31 @ 2.5GHz +31 @ 6GHz	TK	Low cost 6GHz SPDT, medium power, small size package, low insertion loss, high isolation, 1.8V-5.3V

Notes: 1. See Package Dimensions on page 10

# RF Switch ICs continued

## SP3Ts (Single Pole Triple Throw)

Part Number <sup>1</sup>	TYPICAL ELECTRICAL CHARACTERISTICS (TA = 25°C)						Package Code <sup>1</sup>	Description
	Frequency (GHz, max)	Control Voltages (V)	Insertion Loss (dB)	Isolation (dB)	Input Power @0.1 dB compression point (dBm)	Input Power @1.0 dB compression point (dBm)		
<b>NEW</b> CG2430X1	6.0	1.8, 3.0, 5.0	0.50 @ 2.5GHz 0.60 @ 6GHz	28 @ 2.5GHz 25 @ 6GHz	+28 @ 2.5GHz +28 @ 6GHz	+31 @ 2.5GHz +31 @ 6GHz	X1	SP3T specified to 6GHz with high isolation

Notes: 1. See Package Dimensions on page 10

## DPDTs (Double Pole Double Throw)

Part Number	TYPICAL ELECTRICAL CHARACTERISTICS (TA = 25°C)						Package Code <sup>1</sup>	Description
	Frequency (GHz, max)	Control Voltages (V)	Insertion Loss (dB)	Isolation (dB)	Input Power @0.1 dB compression point (dBm)	Input Power @1.0 dB compression point (dBm)		
UPD5738T6N	2.5	1.5, 2.8, 3.6	0.8 @ 1GHz	22 @ 1GHz	+15 @ 1GHz	+20 @ 1GHz	T6N	Only one control pin, low frequency operation, CMOS, 1.5V-3.6V
UPG2162T5N	6.0	2.8, 3.0, 5.0	0.60 @ 2.5GHz 0.85 @ 6GHz	30 @ 2.5GHz 27 @ 6GHz	-	+31 @ 2.5GHz +29 @ 6GHz	T5N	Best isolation of all DPDTs, up to 6GHz operation
UPG2164T5N	6.0	2.8, 3.0, 5.0	0.50 @ 2.5GHz 0.70 @ 6GHz	25 @ 2.5GHz 17 @ 6GHz	-	+31 @ 2.5GHz +29 @ 6GHz	T5N	Lowest cost, lowest insertion loss DPDT. 6GHz operation.

Notes: 1. See Package Dimensions on page 10

# GaAs FETs

## Low Noise GaAs FETs, 1 to 20GHz Typical Specifications @ TA = 25°C

Part Number	Gate Length (μm)	Gate Width (μm)	Test Frequency (GHz)	NF/GA Bias		NF <sub>OPT</sub> (dB)	G <sub>A</sub> (dB)	I <sub>SS</sub> (mA)	Power Bias		P <sub>1dB</sub> (dBm)	Package Code <sup>1</sup>	Package Description
				V <sub>DS</sub> (V)	I <sub>DS</sub> (mA)				V <sub>DS</sub> (V)	I <sub>DS</sub> (mA)			
<b>NEW</b> CE3503M4	-	-	12	2.0	10	0.45	13.2	47	-	-	-	M4	Plastic SMD
<b>NEW</b> CE3512K2	-	-	12	2.0	10	0.30	13.7	47	-	-	-	K2	Micro-X Plastic
<b>NEW</b> CE3520K3	-	-	20	2.0	10	0.55	13.8	40	-	-	-	K3	Micro-X Plastic
<b>NEW</b> CE3521M4	-	-	20	2.0	10	0.70	11.9	40	-	-	-	M4	Plastic SMD
NE3210S01	0.2	160	12	2.0	10	0.35	13.5	40	-	-	-	S01	Plastic SMD
NE3503M04	0.2	160	12	2.0	10	0.55	11.5	40	-	-	-	M04	Plastic SMD
NE3508M04	0.6	800	2	2.0	10	0.45	14.0	90	3.0	30	+18.0	M04	Plastic SMD
NE3509M04	0.6	400	2	2.0	10	0.40	17.5	45	3.0	20	+14.0	M04	Plastic SMD
NE3510M04	0.6	280	2	2.0	10	0.35	19.0	70	3.0	30	+12.0	M04	Plastic SMD
NE3511S02	0.2	160	12	2.0	10	0.30	13.5	40	-	-	-	S02	Micro-X Plastic
NE3512S02	0.2	160	12	2.0	10	0.35	13.5	40	-	-	-	S02	Micro-X Plastic
NE3513M04	0.2	160	12	2.0	6	0.45	13.0	30	-	-	-	M04	Plastic SMD
NE3514S02	0.2	160	20	2.0	10	0.75	10.0	40	-	-	-	S02	Micro-X Plastic
NE3515S02	0.2	200	12	2.0	10	0.3	12.5	60	3.0	25	+14.0	S02	Micro-X Plastic
NE3516S02	0.2	160	12	2.0	10	0.35	14.0	30	-	-	-	S02	Micro-X Plastic
NE3517S03	0.2	160	20	2.0	10	0.70	13.5	40	-	-	-	S03	Micro-X Plastic
NE3520S03	-	160	20	2.0	10	0.65	13.5	40	-	-	-	S03	Micro-X Plastic
NE3521M04	-	-	20	2.0	10	0.85	11	45	-	-	-	M04	Plastic SMD
NE4210S01	0.2	160	12	2.0	10	0.50	13.0	40	-	-	-	S01	Plastic SMD

Notes: 1. See Package Dimensions on page 10

# Silicon MOSFET Devices

## RF Power LD-MOSFETs Typical Specifications @ Tc = 25°C

Part Number	P <sub>OUT</sub> (dBm) TYP	Linear Gain (dB) TYP	Test Conditions				Package Code <sup>1</sup>	Package Description
			Freq (GHz)	P <sub>IN</sub> (dBm)	V <sub>DS</sub> (V)	I <sub>DSO</sub> (mA)		
NE5531079A	+40.0	20.5	0.46	+25	7.5	200	79A	Plastic SMD
NE55410GR	+40.4	25	2.1	+16	28	120	GR	Plastic SMD
NE5550234	+33	23.5	0.46	+15	7.5	40	34	Plastic SMD
	+32.2	18.3	0.90	+17	7.5	40		
NE5550279A	+33	22.5	0.46	+15	7.5	40	79A	Plastic SMD
NE5550779A	+38.5	22	0.46	+25	7.5	140	79A	Plastic SMD
	+37.4	17	0.90	+27	7.5	140		
NE5550979A	+39.5	22	0.46	+25	7.5	200	79A	Plastic SMD
	+38.6	16	0.90	+27	7.5	200		

Notes: 1. See Package Dimensions on page 10

## MOSFET for Microphone Impedance Conversion

Part Number	Supply Voltage (V)	Circuit Current (μA)	Input Capacitance (pF)	Voltage Gain (dB)	Output Noise Voltage (dBV)	Total Harmonic Distortion (%)	HBM ESD (KV)	Package Code <sup>1</sup>
NE5820M53	2	85	1.5	-3	-114	0.1	>8	M53

Notes: 1. See Package Dimensions on page 10

# Silicon Bipolar Transistors

## Single Transistors

Part Number	JEITA <sup>1</sup> Part Number	NPN /PNP	fT TYP (GHz)	Test Freq (GHz)	Test VCE (V)	NF TYP (dB)	MAG TYP (dB)	hFE (TYP)	VCEO MAX (V)	Ic MAX (mA)	Package <sup>2</sup> Type
NE202930	NA	NPN	11	1	5	1.5	15	140	6	100	30 / SOT-323
NE46134	2SC4536	NPN	5.3	1	10	2	9	120	15	250	34 / SOT-89
NE461M02	2SC5337	NPN	5.3	1	10	2	10	120	15	250	M02 / SOT-89
NE46234	2SC4703	NPN	6	1	5	2.3	–	150	12	150	34 / SOT-89
NE462M02	2SC5338	NPN	6	1	5	2.3	–	150	12	150	M02 / SOT-89
NE66219	2SC5606	NPN	21	2	2	1.2	14	80	3.3	35	19 / SOT-523
NE662M04	2SC5508	NPN	25	2	2	1.1	19	70	3.3	35	M04 / SOT-343F
NE663M04	2SC5509	NPN	15	2	2	1.2	14	70	3.3	100	M04 / SOT-343F
NE664M04	2SC5754	NPN	20	2	3	–	12	60	5	500	M04 / SOT-343F
NE67718	2SC5750	NPN	15	2	3	1.7	15	120	6	50	18 / SOT-343
NE67739	2SC5454	NPN	14.5	2	3	1.5	14	110	6	50	39 / SOT-143
NE677M04	2SC5751	NPN	15	2	3	1.7	16	120	6	50	M04 / SOT-343F
NE67818	2SC5752	NPN	12	2	3	1.7	13	120	6	100	18 / SOT-343
NE67839	2SC5455	NPN	12	2	3	1.5	14	110	6	100	39 / SOT-143
NE678M04	2SC5753	NPN	12	2	3	1.7	13.5	120	6	100	M04 / SOT-343F
NE68018	2SC5013	NPN	10	2	6	1.8	13	100	10	35	18 / SOT-343
NE68019	2SC5008	NPN	8	2	3	1.9	11.5	120	10	35	19 / SOT-523
NE68030	2SC4228	NPN	8	2	3	1.9	–	100	10	35	30 / SOT-323
NE68033	2SC3585	NPN	10	2	6	1.8	10	100	10	35	33 / SOT-23
NE68039	2SC4095	NPN	10	2	6	1.8	12	100	10	35	39 / SOT-143
NE68118	2SC5012	NPN	9	1	8	1.2	18	100	10	65	18 / SOT-343
NE68119	2SC5007	NPN	7	1	3	1.4	16.5	120	10	65	19 / SOT-523
NE68130	2SC4227	NPN	7	1	3	1.4	13	140	10	65	30 / SOT-323
NE68133	2SC3583	NPN	9	1	8	1.2	15	100	10	65	33 / SOT-23
NE68139	2SC4094	NPN	9	1	8	1.2	17	150	10	65	39 / SOT-143
NE68518	2SC5015	NPN	12	2	3	1.5	13	110	6	30	18 / SOT-343
NE68519	2SC5010	NPN	12	2	3	1.5	11	110	6	30	19 / SOT-523
NE68539	2SC4957	NPN	12	2	3	1.5	–	110	6	30	39 / SOT-143
NE85618	2SC5011	NPN	6.5	1	10	1.1	16	120	12	100	18 / SOT-343
NE85619	2SC5006	NPN	4.5	1	3	1.2	12.5	120	12	100	19 / SOT-523
NE85630	2SC4226	NPN	4.5	1	3	1.2	–	110	12	100	30 / SOT-323
NE85633	2SC3356	NPN	7	1	10	1.1	13	120	12	100	33 / SOT-23
NE85634	2SC3357	NPN	6.5	1	10	1.8	10	120	12	100	34 / SOT-89
NE85639	2SC4093	NPN	7	1	10	1.1	14.2	120	12	100	39 / SOT-143
NE856M02	2SC5336	NPN	6.5	1	10	1.1	13.5	120	12	100	M02 / SOT-89
NE97733	2SA1977	PNP	8.5	1	-8	1.5	–	60	-12	-50	33 / SOT-23
NE97833	2SA1978	PNP	5.5	1	-10	2	–	40	-12	-50	33 / SOT-23

Notes: 1. JEITA (Japan Electronics and Information Technology Association) equivalent part number 2. See Package Dimensions on page 10



# Silicon Bipolar Transistors continued

## Twin Transistors

Part Number	TEST f (GHz)	NF/GA V <sub>CE</sub> (V)	NF/GA I <sub>c</sub> (mA)	NF TYP (dB)	G <sub>A</sub> TYP (dB)	MAG TYP (dB)	IS <sub>21E</sub> I			f <sub>r</sub> TYP (GHz)	h <sub>FE</sub> TYP	I <sub>c</sub> MAX (mA)	Die	Pkg. Code <sup>1</sup>	Package Style
							V <sub>CE</sub> (V)	I <sub>c</sub> (mA)	TYP (dB)						
UPA800T	2.0	3	5	1.9	9.0	12.0	3	5	7.5	8	120	35	2 each NE680	T	SOT-363
UPA801T	1.0	3	7	1.2	10.0	14.0	3	7	9.0	4.5	120	100	2 each NE856	T	SOT-363
UPA802T	1.0	3	7	1.4	14.0	16.0	3	7	12.0	7.0	100	65	2 each NE681	T	SOT-363
UPA806T	2.0	3	3	1.5	7.5	11.0	3	10	8.5	12.0	110	30	2 each NE685	T	SOT-363
UPA810T	1.0	3	7	1.2	10.0	14.0	3	7	9.0	4.5	120	100	2 each NE856	T	SOT-363
UPA811T	2.0	3	5	1.9	9.0	12.0	3	5	7.5	8	120	35	2 each NE680	T	SOT-363
UPA812T	1.0	3	7	1.4	14	16.0	3	7	12.0	7	100	65	2 each NE681	T	SOT-363

Notes: 1. See Package Dimensions on page 10

# Silicon RFICs

## 3V Silicon MMIC Amplifiers

Part Number	Typical Frequency Range @ 3dB down (MHz)	ELECTRICAL CHARACTERISTICS <sup>5</sup> (T <sub>A</sub> = 25°C)												Package Code <sup>6</sup>	Package Style
		V <sub>CC</sub> (V)	I <sub>CC</sub> (mA)			NF (dB)	Gain (dB)			R <sub>LIN</sub> (dB)	R <sub>LOUT</sub> (dB)	P <sub>1dB</sub> (dBm)	ISOL (dB)		
			MIN	TYP	MAX	TYP	MIN	TYP	MAX	TYP	TYP	TYP	TYP		
UPC2745TB <sup>1</sup>	2700	3	5	7.5	10	6.0	9	12	14	11	5.5	-3.0	38	TB	SOT-363
UPC2746TB <sup>1</sup>	1500	3	5	7.5	10	4.0	16	19	21	13	8.5	-3.7	45	TB	SOT-363
UPC2748TB <sup>2</sup>	1500	3	4.5	6	8	2.8	16	19	21	11.5	8.5	-8.5	40	TB	SOT-363
UPC2749TB <sup>3</sup>	2900	3	4	6	8	4	13	16	18.5	10	13	-12.5	30	TB	SOT-363
UPC2762TB <sup>3</sup>	2900	3	-	27	35	7.0	11.5	15.5	17.5	8.5	12	+7	25	TB	SOT-363
UPC2771TB <sup>2</sup>	2200	3	-	36	45	6	19	21	24	14	9	+11.5	30	TB	SOT-363
UPC8178TK <sup>3</sup>	2700	3	1.4	1.9	2.4	5.5	9.0	11.0	13.5	8	-	-8.0	41	TK	6 pin Recessed Lead
UPC8179TK <sup>3</sup>	Note 4	3	2.9	4.0	5.4	5.0	13.0	15.5	17.5	7	-	0.5	42	TK	6 pin Recessed Lead

Notes: 1. f = 500 MHz test condition 2. f = 900 MHz test condition 3. f = 1900 MHz test condition 4. 100–2400MHz with output port matching 5. Z<sub>L</sub> = 50 Ω for all Electrical Characteristics 6. See Package Dimensions on page 10

## 5V Silicon MMIC Amplifiers

Part Number	Typical Frequency Range @ 3dB down (MHz)	V <sub>CC</sub> (V)	ELECTRICAL CHARACTERISTICS <sup>3</sup> (T <sub>A</sub> = 25°C)											Package Code <sup>4</sup>	Package Style
			I <sub>CC</sub> (mA)			NF (dB)	Gain (dB)			RLIN (dB)	RLOUT (dB)	P <sub>1dB</sub> (dBm)	ISOL (dB)		
			MIN	TYP	MAX	TYP	MIN	TYP	MAX	TYP	TYP	TYP	TYP		
UPC2708TB <sup>2</sup>	2900	5	20	26	33	6.5	13	15	18.5	11	20	+9.2	23	TB	SOT-363
UPC2709TB <sup>2</sup>	2300	5	19	25	32	5.0	21	23	26.5	10	10	+8.7	31	TB	SOT-363
UPC2710TB <sup>1</sup>	1000	5	16	22	29	3.5	30	33	36.5	6	12	+10.8	39	TB	SOT-363
UPC3223TB <sup>2</sup>	3200	5	15	19	24	4.5	20.5	23	22.5	12	12	+6.5	33	TB	SOT-363
UPC3224TB <sup>2</sup>	3200	5	7.0	9.0	12.0	4.3	19	21.5	24	12	17	-3.5	40	TB	SOT-363

Notes: 1. f = 500 MHz test condition 2. f = 1000 MHz test condition 3. Z<sub>L</sub> = 50 Ω for all Electrical Characteristics 4. See Package Dimensions on page 10

## Frequency Upconverters

Part Number	ELECTRICAL CHARACTERISTICS (T <sub>A</sub> = 25°C)								Package Code <sup>4</sup>	Package Style
	IF Input Frequency Range @3 dB Down (MHz)	RF Output Frequency Range (MHz)	V <sub>CC</sub> (V)	I <sub>CC</sub> (mA)	Conversion Gain (dB)	P <sub>SAT</sub> <sup>3</sup> (dBm)	Noise Figure (dB)	OIP <sub>3</sub>		
	TYP	TYP		TYP	TYP	TYP	TYP			
UPC8106TB <sup>1</sup>	50-400	400-2000	3.0	9.0	10.0	-2.0	8.5	+5.5	TB	SOT-363
UPC8172TB <sup>2</sup>	50-400	800-2500	3.0	9.0	8.5	0.0	10.4	+6.0	TB	SOT-363

Notes: 1. RF = 900 MHz, LO = 660 MHz, PLO = -5 dBm 2. RF = 1900 MHz, LO = 1660 MHz, PLOIN = -5 dBm 3. PIN = 0 dBm 4. See Package Dimensions on page 10

## Frequency Downconverters

Part Number	ELECTRICAL CHARACTERISTICS (T <sub>A</sub> = 25°C)							Package Code <sup>2</sup>	Package Style
	RF Input Frequency Range @3 dB Down (MHz)	IF Output Frequency Range @3 dB Down (MHz)	V <sub>CC</sub> (V)	I <sub>CC</sub> (mA)	Conversion Gain (dB)	P <sub>SAT</sub> (dBm)	Noise Figure (dB)		
	TYP	TYP		TYP	TYP	TYP	TYP		
UPC2756TB	100-2000	10-300	3.0	5.9	14	-12	13	TB	SOT-363
UPC2757TB <sup>1</sup>	100-2000	20-300	3.0	5.6	13	-8	13	TB	SOT-363
UPC2758TB <sup>1</sup>	100-2000	20-300	3.0	11	17	-4	13	TB	SOT-363
UPC8112TB <sup>1</sup>	800-2000	100-300	3.0	8.5	13	-3	11.2	TB	SOT-363

Note: 1. AGC Amp and Mixer Block only 2. See Package Dimensions on page 10

# Package Dimensions Units in mm

These dimensions are for the package only. For detailed dimensions including leads, please refer to the datasheet.

**18 Package** (1.25 x 2.0 x 0.9)

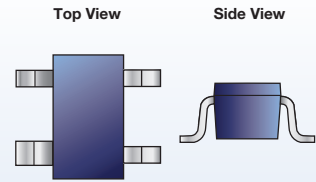

**19 Package** (0.8 x 1.6 x 0.75)

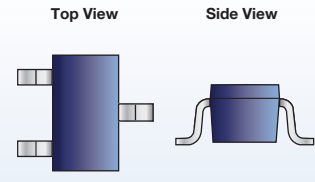

**30 Package** (1.25 x 2.0 x 0.9)

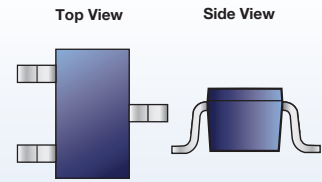

**33 Package** (1.5 x 2.9 x 1.4)

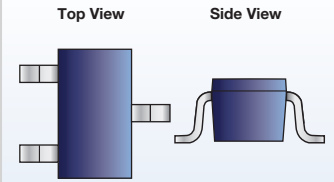

**34 Package** (2.5 x 4.5 x 1.5)

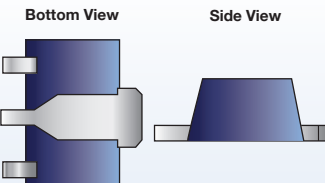

**39 Package** (1.5 x 2.9 x 1.1)

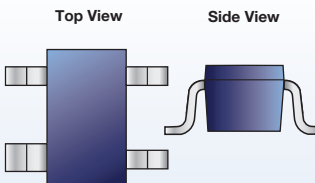

**79A Package** (4.2 x 4.4 x 0.9)

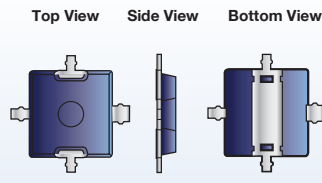

**GR Package** (5.2 x 5.5 x 0.9)

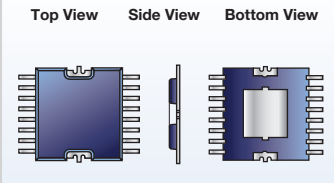

**M02 Package** (2.45 x 4.5 x 1.5)

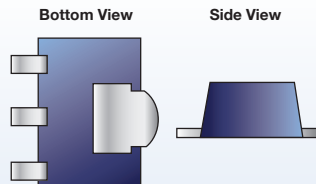

**M4 / M04 Package** (1.25 x 2.0 x 0.6)

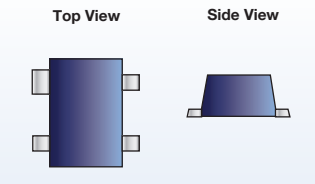

**M53 Package** (1.0 x 1.2 x 0.33)

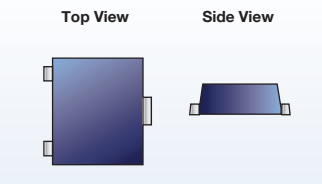

**S01 Package** (2.0 x 2.0 x 1.5)

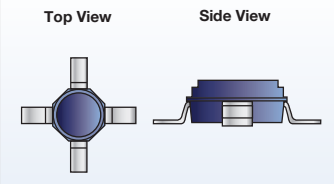

**K2 / K3 / S02 / S03 Package** (2.6 x 2.6 x 1.5)

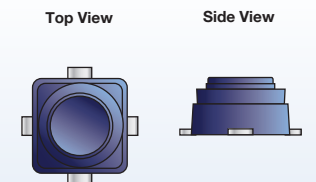

**T / TB / M2 Package** (1.25 x 2.0 x 0.9)

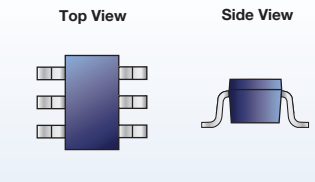

**M6 / TK Package** (1.1 x 1.5 x 0.55)

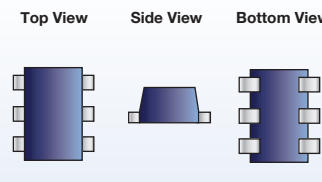

**T5N / X3 Package** (1.5 x 1.5 x 0.37)

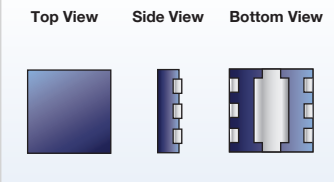

**T6N / T6X Package** (1.5 x 1.5 x 0.37)

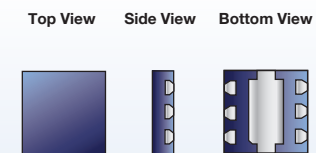

**X1 Package** (1.5 x 1.5 x 0.37)



**X2 Package** (1.0 x 1.0 x 0.37)

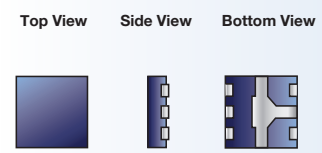

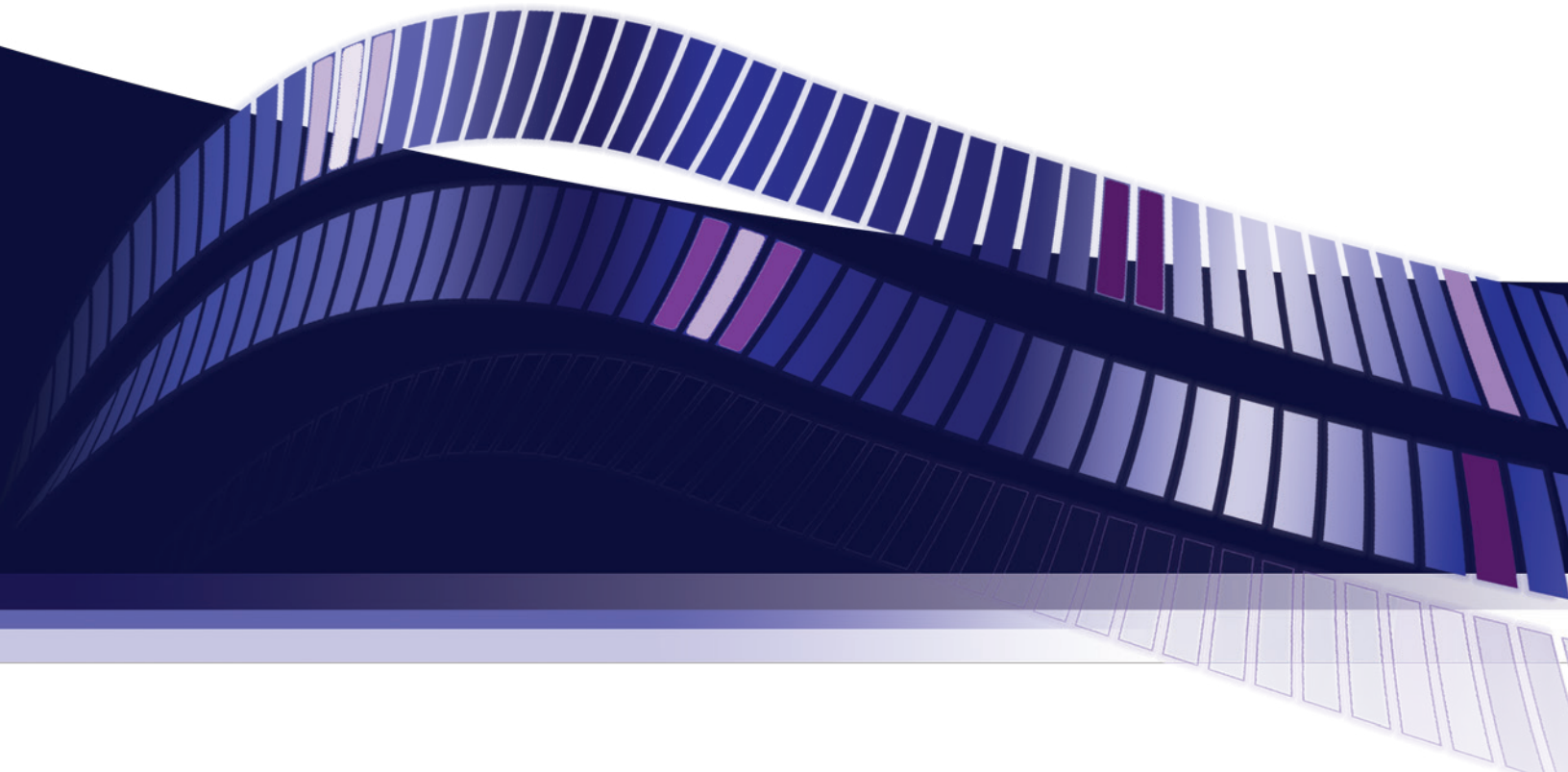

**CEL** Contact Us

4590 Patrick Henry Drive  
Santa Clara, CA 95054  
Tel: (408) 919-2500  
E-mail: [r fw@cel.com](mailto:r fw@cel.com)

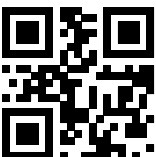

**Learn more**  
[www.cel.com/rf](http://www.cel.com/rf)



For a complete list of sales offices, representatives and distributors,  
Please visit our website: [www.cel.com/contactus](http://www.cel.com/contactus)