

Tag-it HF-I Pro Transponder IC

Reference Guide

October 2007



SCBU045 (11-09-21-065)

Tag-it HF-I Pro Transponder IC

Reference Guide



Literature Number: SCBU045 (11-09-21-065)
October 2007



Preface	5
1 Introduction	7
1.1 General.....	8
1.2 System Description	8
1.3 Product Description.....	8
1.4 Functional Description.....	8
1.5 Memory Organization	9
1.6 Command Set	10
1.7 Ordering Information and Part Numbers	10
2 Specification	11
2.1 Electrical Specification	12
2.2 Mechanical Wafer Specification	12
2.3 Mechanical Die Specification	14
2.4 Bump Specification.....	15
3 Shipping, Packing & Further Handling	17
3.1 Lot Definition	18
3.2 Wafer identification	18
3.3 Wafer Map File	20
3.4 Ink Dot Specification	20
3.5 Packing for Wafers.....	21
3.6 Packing for Sawn Wafers	22
3.7 Barcode Label	24
3.8 Storage Conditions	24
3.9 Antenna Calculation.....	24
4 Regulatory, Safety, and Warranty Notices	27
4.1 Regulatory, Safety, and Warranty Notices	28
4.2 Warranty and Liability.....	28
4.3 Hazards from Electrostatic Discharge ESD.....	28
A Terms & Abbreviations	29

List of Figures

1-1	RFID System With Reader, Antenna, and Tag-it HF-I Transponder	8
1-2	Memory Organization of the Tag-it HF-I Pro Transponder IC	9
2-1	Wafer on FFC	13
2-2	Antenna and Test Pad Location	14
2-3	Cross Section of Bump	15
3-1	Position of Wafer Identification Code	18
3-2	Wafer Identification Code 1	19
3-3	Wafer Identification Code 2	19
3-4	Ink Dot Drawing	21
3-5	Packing of Wafers	22
3-6	Packing of Sawn Wafers (Multi)	23
3-7	Packing of Sawn Wafers (Single)	23
3-8	Barcode Label	24
3-9	Recommended Operating Range – Impedance vs Antenna Q	25

List of Tables

1-1	Command Set for Tag-it HF-I Pro Transponder IC	10
1-2	Part Numbers	10
2-1	Absolute Maximum Ratings	12
2-2	Recommended Operating Conditions	12
2-3	Electrical Characteristics	12
2-4	General Mechanical Wafer Specification	12
2-5	Mechanical Wafer Specification After Grinding, Sawing on FFC	13
2-6	Mechanical Die Specification	14
2-7	Antenna and Test Pad Location	14
2-8	Bump Specification	15
3-1	Ink Dot Specification	20
3-2	Ink Dot Placement	21
3-3	Storage Conditions	24
3-4	Antenna System Parameters	25

Edition Three – October 2007

This is the third edition of this reference guide. It contains a description of the Tag-it HF-I Pro Transponder IC, the specifications, part numbers, dimensions and instructions for further handling.

Important Notice

Texas Instruments (TI) reserves the right to make changes to its products or services or to discontinue any product or service at any time without notice. TI provides customer assistance in various technical areas, but does not have full access to data concerning the use and applications of customer's products.

Therefore, TI assumes no liability and is not responsible for customer applications or product or software design or performance relating to systems or applications incorporating TI products. In addition, TI assumes no liability and is not responsible for infringement of patents and/or any other intellectual or industrial property rights of third parties, which may result from assistance provided by TI.

TI products are not designed, intended, authorized or warranted to be suitable for life support applications or any other life critical applications which could involve potential risk of death, personal injury or severe property or environmental damage.

The **TIRIS™** and **TI-RFid™** logos, and the words **TIRIS**, **TI-RFID**, and **Tag-it™** are trademarks or registered trademarks of Texas Instruments Incorporated.

Copyright 2007 Texas Instruments Incorporated (TI)

This document be downloaded onto a computer, stored and duplicated as necessary to support the use of the related TI product. Any other type of duplication, circulation or storage on data carriers in any manner not authorized by TI represents a violation of the applicable copyright laws and shall be prosecuted.

About This Guide

This reference guide for the Tag-it HF-I Pro Transponder IC is designed for use by TI partners who are engineers experienced with Radio Frequency Identification Devices (RFID) and the processing of wafers.

Regulatory, safety and warranty notices that must be followed are given in Chapter 4.

Conventions

WARNING

A WARNING IS USED WHERE CARE MUST BE TAKEN, OR A CERTAIN PROCEDURE MUST BE FOLLOWED, IN ORDER TO PREVENT INJURY OR HARM TO YOUR HEALTH.

CAUTION

This indicates information on conditions that must be met, or a procedure that must be followed, which, if not heeded, could cause permanent damage to the equipment or software.

Note: Indicates conditions that must be met, or procedures that must be followed, to ensure proper functioning of the equipment or software.

Note: Information: Indicates information that makes usage of the equipment or software easier.

If You Need Assistance

For more information, please contact the sales office or distributor nearest you. This contact information can be found on our web site at: <http://www.ti-rfid.com>.

Introduction

This chapter introduces you to the Tag-it HF-I Pro Transponder IC.

Topic	Page
1.1 General.....	8
1.2 System Description.....	8
1.3 Product Description	8
1.4 Functional Description	8
1.5 Memory Organization	9
1.6 Command Set.....	10
1.7 Ordering Information and Part Numbers	10

1.1 General

The **Tag-it HF-I Pro** Transponder IC is part of TI's 13.56 MHz product family, which is based on the ISO/IEC 15693 standard for contactless integrated circuit cards (vicinity cards) and ISO/IEC 18000-3 standard for item management. The **Tag-it HF-I Pro** Transponder IC builds the basis for various available inlay shapes, which are used as consumable smart labels in markets requiring quick and accurate identification of items, such as:

- asset tagging
- electronic ticketing
- anti-counterfeit prevention
- building access badges

User data is written to and read from memory blocks using a non-volatile EEPROM silicon technology. Each block is separately programmable by the user and can be locked to protect data from modification. Once the data has been 'locked' it can only be changed by the password protected write command.

Multiple transponders, which appear in the Readers RF field, can be identified, read from and written to by using the **Unique Identifier (UID)**, which is programmed and locked at the factory and can not be changed.

1.2 System Description

For operation, a reader with antenna is required to send a command to the transponder and to receive its response (see [Figure 1-1](#)). The command of the Reader can be either in addressed or non-addressed mode. The Transponder does not transmit data until the reader sends a request (Reader talks first principle).

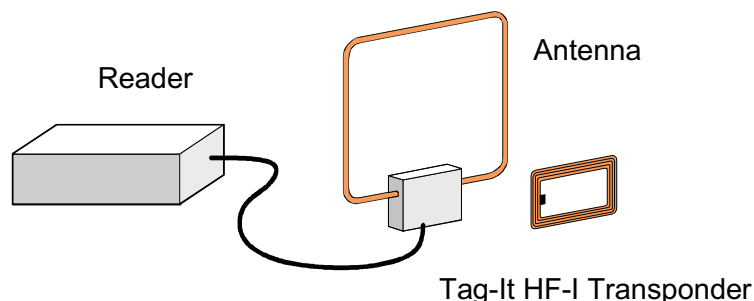

Figure 1-1. RFID System With Reader, Antenna, and Tag-it HF-I Transponder

1.3 Product Description

The Tag-it HF-I Pro Transponder IC is compliant to the ISO/IEC 15693 and ISO/IEC 18000-3 standard. To build a complete transponder, the Tag-it HF-I Pro Transponder IC has to build a resonance circuit with the antenna it is assembled on (e.g., an etched aluminum antenna).

1.4 Functional Description

The Tag-it HF-I Pro Transponder IC is a low-power, full-duplex Transponder IC for use with passive contactless identification transponder systems.

The transponder IC is designed to operate with a 13.56 MHz carrier frequency. The ISO standard defines, for some communication parameters, several modes in order to meet different international radio regulations and different application requirements. Therefore, communication between the reader and the transponder (Down-Link communication) takes place using ASK modulation index between 10% and 30% or 100% and datacoding (pulse position modulation) '1 out of 4' or '1 out of 256'.

According to ISO 15693 Up-Link communication (Transponder to Reader) can be accomplished with one subcarrier (ASK modulation) or with two subcarrier (FSK modulation). Both modes (ASK and FSK) can operate with either high or low data rate. **The transponder answers in the mode it was interrogated from the reader and supports all communication parameter combinations.** Up- and Down-Link are frame synchronized and CRC check sum secured.

Each Tag-it HF-I Pro Transponder IC has a 'unique' address (UID) stored in two blocks, which are factory-programmed and 64 bits long ($=2^{64}$ different addresses). This can be used for addressing each transponder uniquely and individually for a one-to-one exchange between the reader and the transponder. A mechanism to resolve collisions of a multiplicity of transponders (Anticollision) is also implemented. This special feature allows multiple transponders to be read simultaneously and offers the capability to inventory, in a very short time, a large number of transponders by their unique address, provided they are within the reader operating range.

Also, the **Application Family Identifier (AFI)**, which is optional in the ISO15693 is supported by the Tag-it HF-I Pro Transponder.

For more details about the communication between reader and transponder see ISO/IEC 15693 and the Tag-it HF-I Pro Extended Command Specification.

1.5 Memory Organization

User data is read and stored in a 256 bit non-volatile user memory that is organized in 8 blocks. Each block with 32 bit is user programmable and can be locked individually to protect data from modification. Once set, the lock bit cannot be reset. The user memory is field programmable per block. Two levels of block locking are supported: Individual block locking by the user (U) or individual block locking of factory programmed data (F) during manufacturing. Bit 2 of the "Block Security Status" Byte defined in ISO 15693-3 is used to store the Factory Lock Status of the Block. Factory Block locking irreversibly protects the locked data from any further reprogramming. User locked blocks can be reprogrammed by use of the password protected write command.

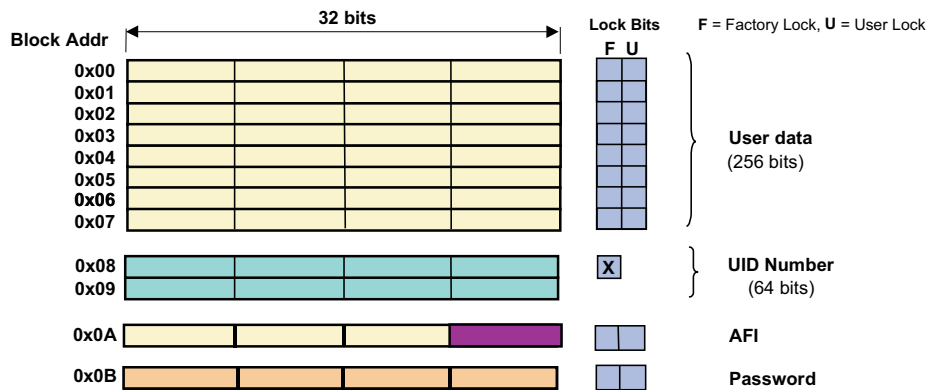

Figure 1-2. Memory Organization of the Tag-it HF-I Pro Transponder IC

1.6 Command Set

Table 1-1. Command Set for Tag-it HF-I Pro Transponder IC

Request	Request Code	Request Mode				
		Inventory	Addressed	Non-Addressed	AFI	Opt. Flag
ISO 15693 Mandatory and Optional Commands						
Inventory	0x01	√	–	–	√	0/–
Stay Quiet	0x02	–	√	–	–	0/–
Read_Single_Block	0x20	–	√	√	–	–/1
Write_Single_Block	0x21	–	√	√	–	–/1
Lock_Block	0x22	–	√	√	–	–/1
TI Custom Commands						
Kill	0xA4	–	√	–	–	–/1
WriteSingleBlockPwd	0xA5	–	√	–	–	–/1

Note: The Option Flag (Bit 7) of the ISO 15693 defined Request Flags must be set to 1 for all Write and Lock commands to respond properly.

For reliable programming we recommend a programming time ≥ 10 ms before the reader sends the End Of Frame (EOF) to request the response from the Transponder.

1.7 Ordering Information and Part Numbers

The Tag-it HF-I Pro Transponder IC is available with following finishing options:

Table 1-2. Part Numbers

Part-Number	Bumping		Inking	Grinding	Sawing	Packing	
	NI/AU	AU				Multi Wafer	Single Wafer
RF-HDT-SJLS-G1	Yes		Yes	Yes	Yes		Yes
RF-HDT-AJLS-G1		Yes	Yes	Yes	Yes		Yes

Note: Other finishing options on request

Specification

This chapter provides the electrical and mechanical specifications of the Tag-it HF-I Pro Transponder IC.

Topic	Page
2.1 Electrical Specification	12
2.2 Mechanical Wafer Specification	12
2.3 Mechanical Die Specification	14
2.4 Bump Specification	15

2.1 Electrical Specification

Table 2-1. Absolute Maximum Ratings

Parameter	Symbol	Note	Min	Nom	Max	Unit
Antenna Input Current	Iant_dc				10	mA
Antenna Input Voltage	Vant_dc				10	V
Storage Temperature	Ts		-40		125	°C
Junction (Chip) Temp.	Tj				150	°C
ESD Immunity	ANT1, ANT2, TDAT, GND	HBM	2.5 2.0			kV

Note: Stress beyond the limits of those listed under 'Absolute Maximum Ratings' cause permanent damage to the device. Functional operation of the device under these or any other conditions beyond those indicated under 'Recommended Operating Conditions' is not implied. Exposure to absolute-maximum-rated conditions for extended time affect device reliability.

Table 2-2. Recommended Operating Conditions

Parameter	Symbol	Note	Min	Nom	Max	Unit
Operating temperature	TA		-40		85	°C
Carrier frequency	fTX			13.56		MHz
Antenna input voltage	VANT	@ fTX unmodulated	2.5		Vlim	V
Impedance of LC circuit	Z		6.5		15.5	kΩ

Table 2-3. Electrical Characteristics

Parameter	Symbol	Note	Min	Nom	Max	Unit
Input capacitance	C _{IN}	@ 2V _{RMS}	-10%	23.5	10%	pF
Operating supply current	ICC	VANT=min			25	μA
		Programming			35	
Uplink modulation index	M _{PICC}	VANT<7V	0.1		0.3	
Limiter clamping voltage	Vlim				10	V
Data retention	tDRET	55C	10			Years
Write and erase endurance	W&E	Ta=25C	100 000			Cycles

Note: For highest possible read-out coverage we recommend to operate readers at a modulation depth of 20% or higher.

2.2 Mechanical Wafer Specification

Table 2-4. General Mechanical Wafer Specification

Parameter	Value
Wafer diameter	200 mm ±0.3 mm (8 inch)
Thickness	711 μm
Scribe line width	84 μm
Electrical connection of substrate	VSS potential
Complete dies per wafer	24172

Table 2-5. Mechanical Wafer Specification After Grinding, Sawing on FFC

Parameter		Value
Backside Material		Si
Roughness:		
Ra		500 Å
Rtm		2500 Å
	Product	
Thickness	RF-HDT-SJLS-G1	150 μm ± 5 μm
	RF-HDT-AJLS-G1	

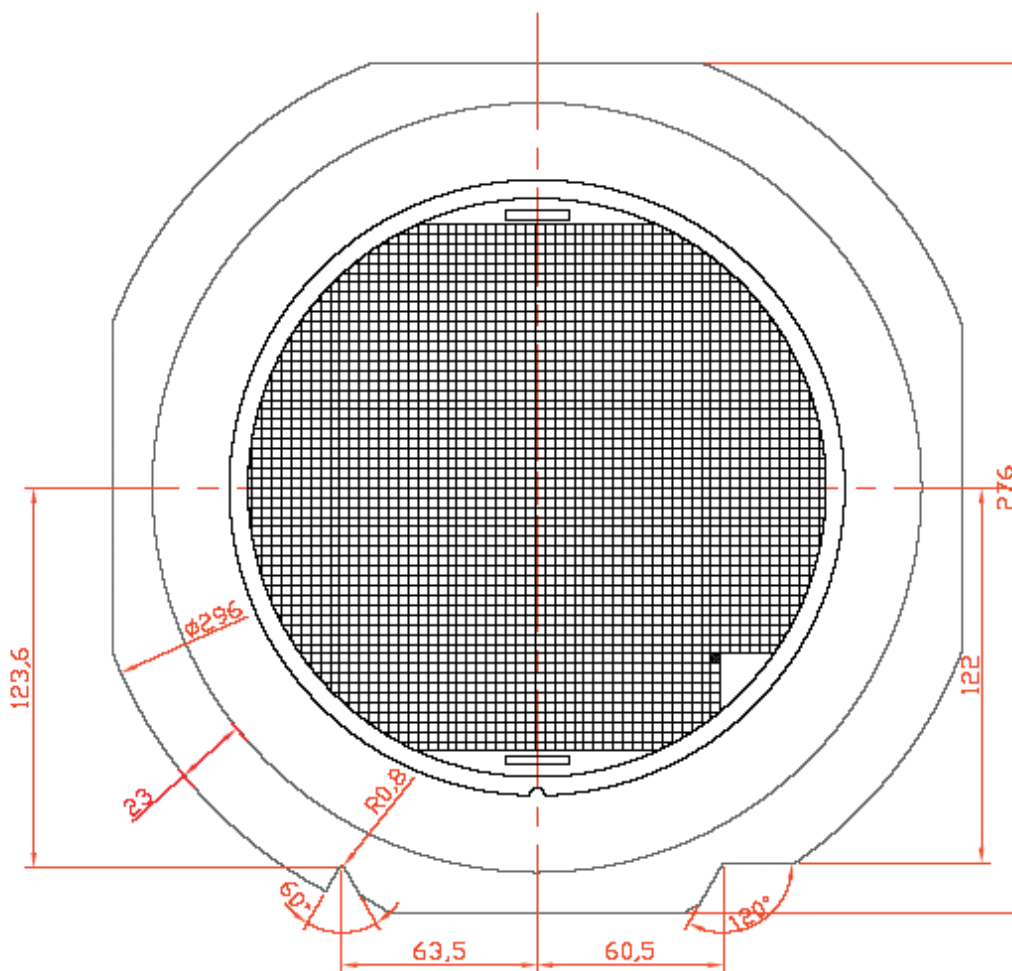

Figure 2-1. Wafer on FFC

2.3 Mechanical Die Specification

Table 2-6. Mechanical Die Specification

Parameter	Value
Bond pad metallization material	ALCu 0.5 %
Bond pad metallization thickness	0.95 μm
Bond and test pad location	Table 2-7
Die dimension (including scribe line)	1080 * 1080 $\mu\text{m} \pm 15 \mu\text{m}$
Die dimension (excluding scribe line)	996 * 996 $\mu\text{m} \pm 15 \mu\text{m}$
Top side passivation material	SiNi
Passivation thickness	1.1 μm

Table 2-7. Antenna and Test Pad Location

Pad No.	Name	LLCx[μm]	LLCy[μm]	URCx[μm]	URCy[μm]
1	ANT1	30	30	n.a.	n.a.
2	ANT2	n.a.	n.a.	966	966
Test pad					
3	TDAT	118	866	168	936
4	GND	836	60	886	130

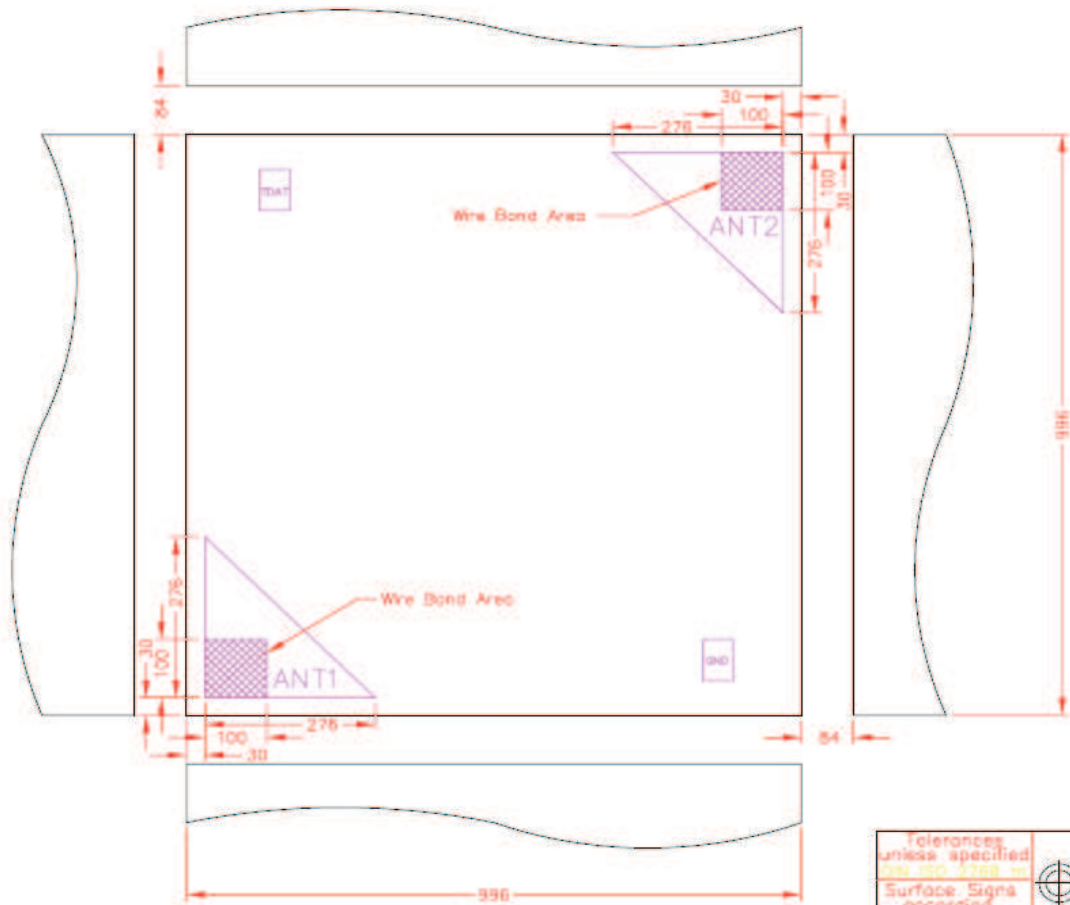

Figure 2-2. Antenna and Test Pad Location

2.4 Bump Specification

Table 2-8. Bump Specification

Parameter	Value	
Bump material	NI covered with AU, chemical process	AU
Bump height	25 $\mu\text{m} \pm 10\%$	20 $\mu\text{m} \pm 3 \mu\text{m}$
Bump hardness	>HV 450	HV 35-80
Surface roughness	<1 μm	< 3 μm
Shear strength	>150 cN	>400 cN

Note: Contact between the test pads and the antenna is not allowed as it can have an impact on the electrical performance of the transponder.

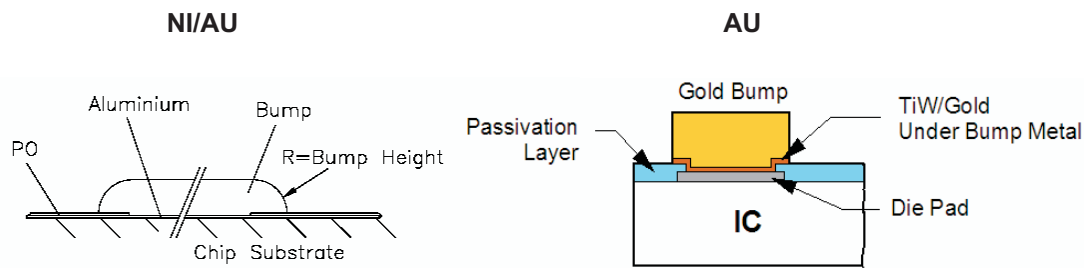

Figure 2-3. Cross Section of Bump

Shipping, Packing & Further Handling

Topic	Page
3.1 Lot Definition	18
3.2 Wafer identification	18
3.3 Wafer Map File	20
3.4 Ink Dot Specification	20
3.5 Packing for Wafers	21
3.6 Packing for Sawn Wafers	22
3.7 Barcode Label	24
3.8 Storage Conditions	24
3.9 Antenna Calculation	24

3.1 Lot Definition

A definite quantity of wafers from the same diffusion batch produced under presumed uniform conditions. Occasionally a lot equals 25 wafers.

3.2 Wafer identification

Each wafer is marked with laser marking to identify the wafer. The wafer map file is linked to the wafer identification. There are two marks on the wafer.

The following figure shows the position of the wafer identification codes. The reference die is the black marked die in the corner at the right lower position of the wafer.

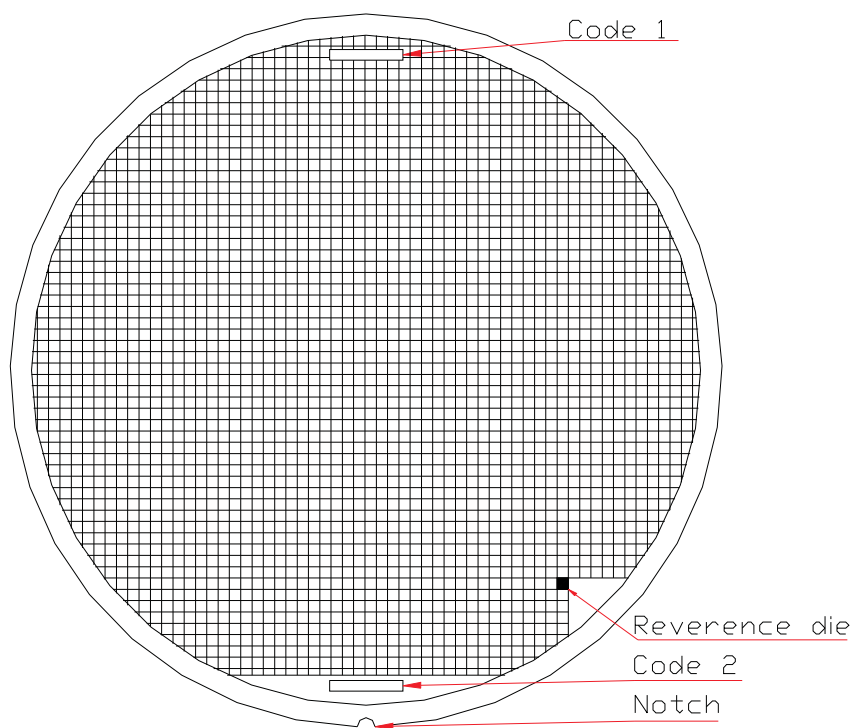

Figure 3-1. Position of Wafer Identification Code

Code 1: Wafer Lot number naming rule:

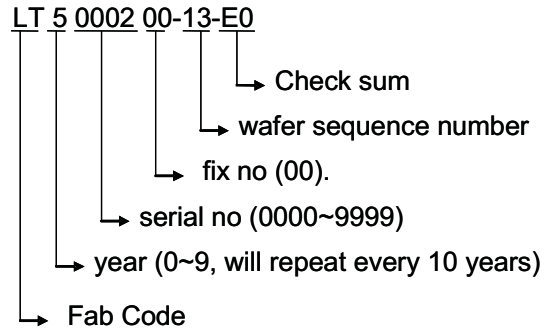

Figure 3-2. Wafer Identification Code 1

Code 2: Wafer Lot number naming rule:

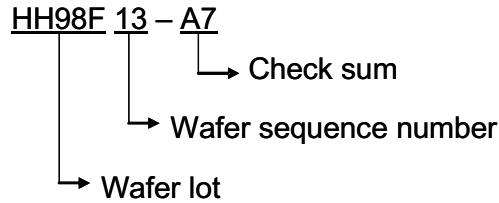
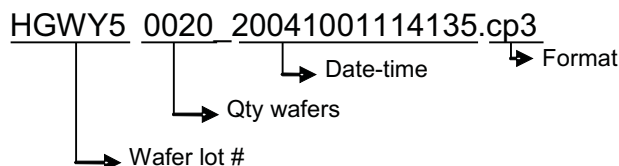

Figure 3-3. Wafer Identification Code 2

3.3 Wafer Map File

All lots are supplied with wafer mapping file. This mapping file is stored on a CD and enclosed in the pack box.

The mapping file is stored for 3 years, if any problem might occur. We handle our TI world wide wafer map standard. The wafer file name is explained as follows:



Wafer map files are provided in a TI Worldwide (WW) format, which is in ASCII text form. An example of the TI WW wafer map file is shown below. Contact your sales representative to obtain details on the TI WW format.

```

FACILITY=UMC-F8E
LOT=HGWY5
DEVICE=$8TMS37114APK
WAFERS=20
X_SIZE=074.134
Y_SIZE=083.858
BIN_NAME.01="G,PASS"
BIN_NAME.09="FAIL"
STATUS="PROD"
SCRIBE="BOTTOM,15,NTRL,FAB"
WAFER_SIZE=200
WAFERID.01=LT5000200-13-E0
NUM_BINS.01=01
BIN_COUNT.01.01=02463
MAP_XY.01.01="Y-10 19 15 12 10/8
Y-9 20 18 15 13/12 9/7
Y-8 20/14 12/10 8/6 3
Y-7 15/13 10 8 4 2"
  
```

3.4 Ink Dot Specification

All Tag-it HF-I Pro Transponder ICs are electrically tested and dies that fail the probe test will be inked. Bump failures are not marked with an ink dot.

Table 3-1. Ink Dot Specification

Parameter	Value
Diameter	Min 250 µm
	Max 600 µm
Height	Max 25 µm
Colour	Black
Position	Central, not to touch bond pads

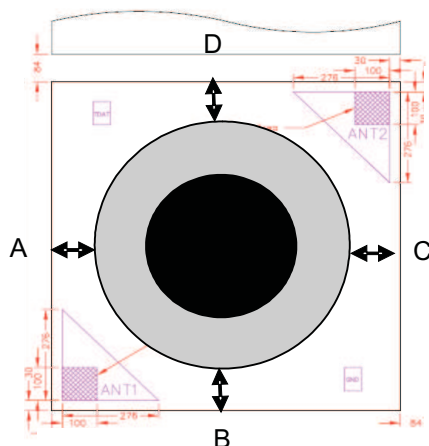

Figure 3-4. Ink Dot Drawing

Table 3-2. Ink Dot Placement

No.	Max	Min	Remark
A	400	150	
B	400	150	
C	400	150	
D	400	150	
Ink	600	250	Size limit

3.5 Packing for Wafers

The wafers are packed for transportation to protect them against shock, static discharge and contamination in a wafer shipper box up to 25 wafers. This box is packed in an antistatic moisture bag with silica gel and in a double layered carton box.

Note: When the silica gel has changed the color to blue, it is an indication that moisture has entered the bag.

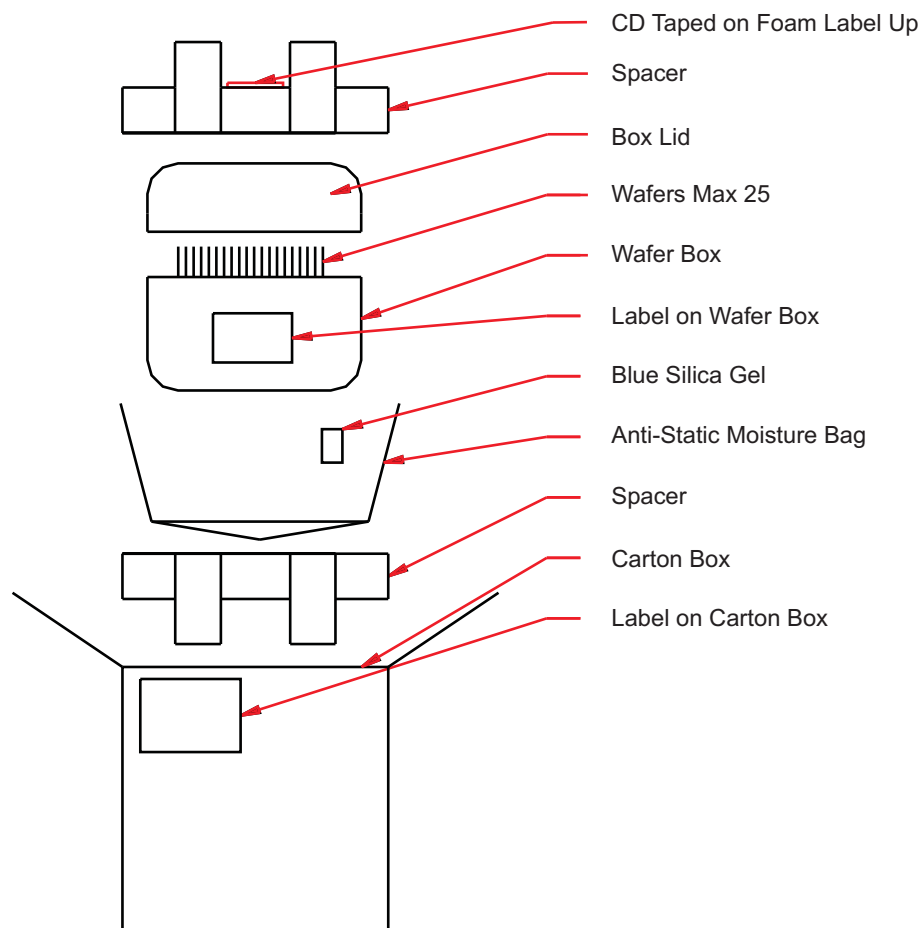

Figure 3-5. Packing of Wafers

3.6 Packing for Sawn Wafers

Packing in Multi Wafer Box

Sawn wafers are mounted on foil and delivered on standard 8" disco wafer frame (see [Figure 2-1 Wafer on FCC](#)). A special plastic container is used to store up to 25 wafers in frames. This plastic container is packed in an antistatic moisture bag with silica gel and in a double layered carton box.

Note: When the silica gel has changed the color to blue, it is an indication that moisture has entered the bag.

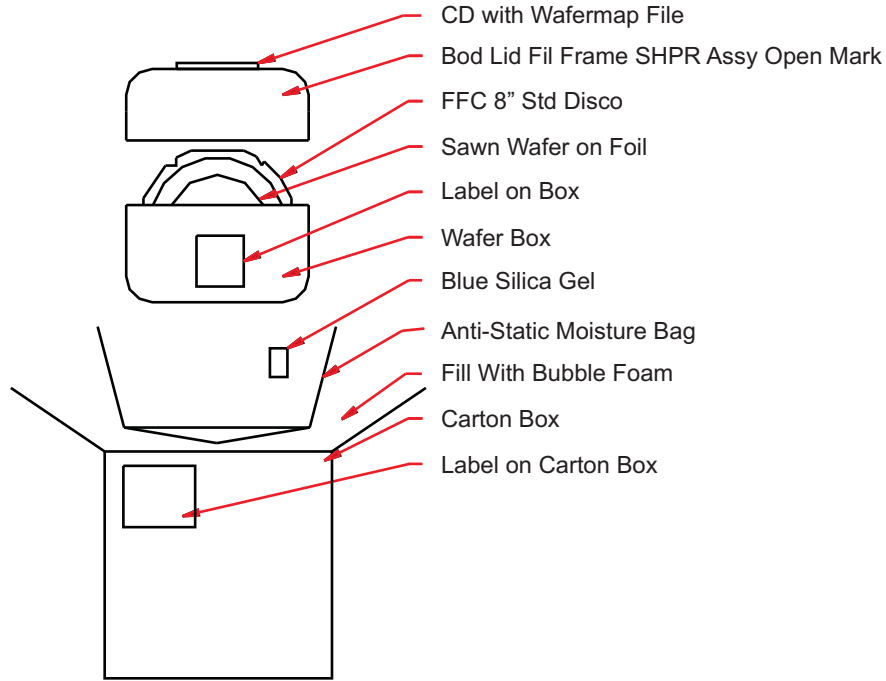

Figure 3-6. Packing of Sawn Wafers (Multi)

Packing in Single Wafer Box

Sawn wafers are mounted on foil and delivered on standard 8" disco wafer frame (see [Figure 2-1](#) Wafer on FCC). A special plastic container is used to store the wafer in frames. This plastic container is packed in an antistatic moisture bag and in a carton box.

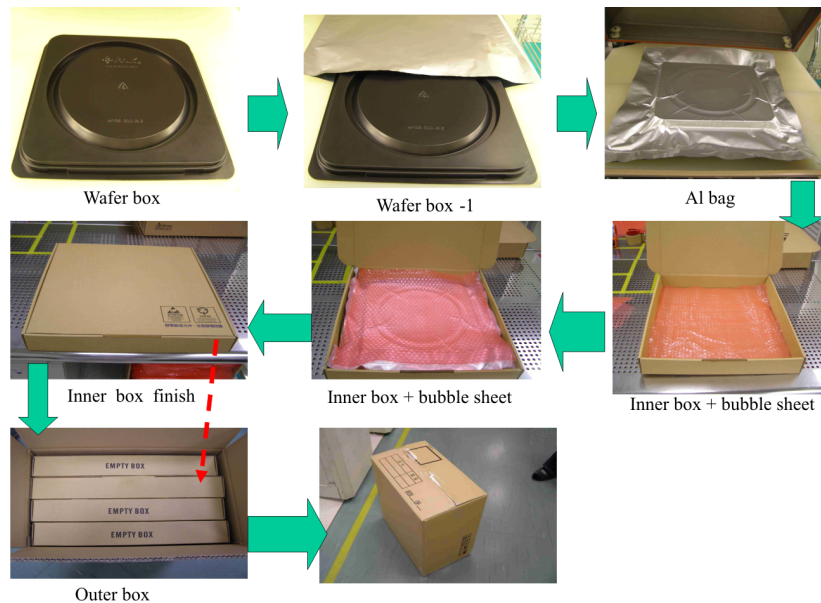

Figure 3-7. Packing of Sawn Wafers (Single)

3.7 Barcode Label

The following figure shows the barcode label that is placed on the packing box, the wafer container and the CD with the map file.

Note: The data provided below is an example and should only be viewed as guide values.



- (1P) Part Number
- (Q) Quantity of functional Chips
- (D) Datecode; Lot Number

Figure 3-8. Barcode Label

3.8 Storage Conditions

The wafers should be kept in the original packing during storage.

Table 3-3. Storage Conditions

Parameter	Value
Temperature	20°C ± 5°C
Atmosphere	Dried N ₂ or dried air with 40%–60% r.h.
Duration	Max. 6 months

3.9 Antenna Calculation

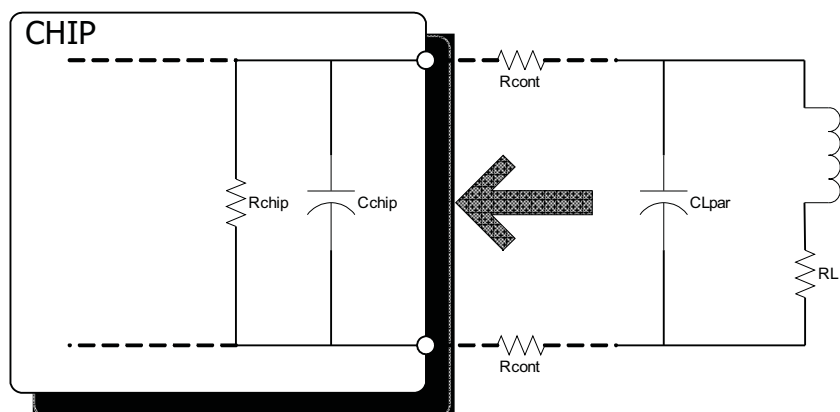

- Rchip: IC Input Impedance
- Cchip: IC Input Capacitance
- Rcont: Pad/assembly contact resistance
- CLpar: Parasitic capacitance of antenna
- RL: Series resistance of antenna
- L: Antenna Inductance

Resonance frequency:

$$f_{res} = \frac{1}{2 * \pi * \sqrt{L * C_{chip}}}$$

Total quality factor:

$$Q_{res} = \frac{Q_c * Q_l}{Q_c + Q_l}$$

Input impedance:

$$Z = Q_{res} * \sqrt{\frac{L}{C_{chip}}}$$

Based on an IC capacitance of 23.5 pF, the impedance shall be matched to be in the specified impedance range of 6.5 to 15.5 kΩ to fit the IC capabilities.

Note: If $Z > 15.5 \text{ k}\Omega$, reduced performance of read range must be considered.

Table 3-4. Antenna System Parameters

Parameter	Min	Nom	Max	Tolerance [%]	Test conditions	Comment
Cchip [pF]	21.15	23.5	25.85	10	13.56 MHz @ 2 Vrms	
Qchip	80	100	120	20		
L [μH]	5.74	5.86	5.98	2	13.56 MHz @ 2 Vrms	
QL	15	40	44	10		
fres [MHz]	12.8	13.56	14.44			
Qres	12.63	28.57	32.2			
Z [kΩ]	6.58	14.27	15.48			

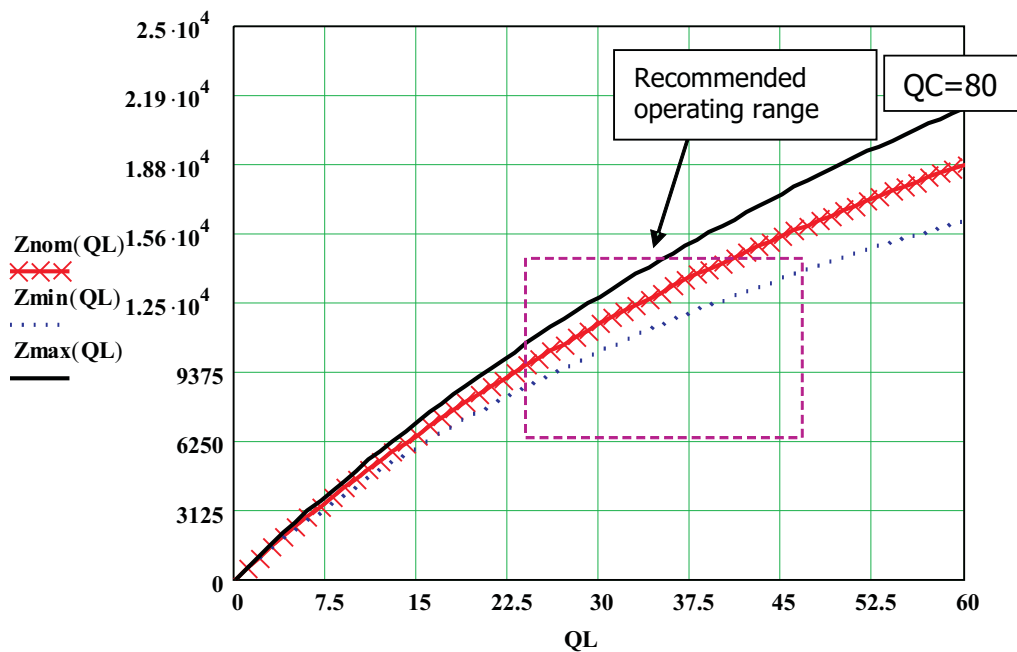

Figure 3-9. Recommended Operating Range – Impedance vs Antenna Q

Regulatory, Safety, and Warranty Notices

This chapter describes important safety precautions and safety regulations.

Topic	Page
4.1 Regulatory, Safety, and Warranty Notices	28
4.2 Warranty and Liability	28
4.3 Hazards from Electrostatic Discharge ESD	28

4.1 Regulatory, Safety, and Warranty Notices

An RFID system comprises an RF transmission device, and is therefore subject to national and international regulations.

A system reading from or writing to these transponders may be operated only under an experimental license or final approval issued by the relevant approval authority. Before any such device or system can be marketed, an equipment authorization must be obtained from the relevant approval authority.

The Tag-it HF-I Pro Transponder IC has been manufactured using state-of-the-art technology and in accordance with the recognized safety rules.

Observe precautions in operating instructions

- Condition for the safe processing, handling and fault-free operation of the Tag-it HF-I Pro Transponder IC is the knowledge of the basic safety regulations.
- All persons who operate with the Tag-it HF-I Pro Transponder IC must observe the guidelines and particularly the safety precautions outlined in this document.
- In addition, basic rules and regulations for accident prevention applicable to the operating site must also be considered.

4.2 Warranty and Liability

The "General Conditions of Sale and Delivery" of Texas Instruments Incorporated or a TI subsidiary apply. Warranty and liability claims for defect products, injuries to persons and property damages are void if they are the result of one or more of the following causes:

- improper use of the transponders IC
- unauthorized assembly, operation and maintenance of the transponders IC
- operation of the transponder IC with defective and/or non-functioning safety and protective equipment
- failure to observe the instructions given in this document during transport, storage, assembly, operation, maintenance and setting up of the transponder IC
- unauthorized changes to the transponder IC
- insufficient monitoring of the transponder ICs' operation or environmental conditions
- repairs
- catastrophes caused by foreign bodies and acts of God.

CAUTION

Tag-it HF-I Pro Transponder ICs are 100% thoroughly tested. It is the responsibility of TI's customer to evaluate their assembly process for compatibility with the Tag-it HF-I Pro Transponder IC properties and to ensure through appropriate process controls that determined machine and material parameter are met on an ongoing basis. TI does not accept warranty claims for material that has already undergone packaging or conversion process.

4.3 Hazards from Electrostatic Discharge ESD

WARNING

ELECTRONIC DEVICES CAN ALSO BE DESTROYED BY ELECTROSTATIC ENERGY.

Terms & Abbreviations

A list of the abbreviations and terms used in various TI-RFID manuals can now be found in a separate manual:

TI-RFID Product Manuals – Terms & Abbreviations

Document number 11-03-21-002

IMPORTANT NOTICE

Texas Instruments Incorporated and its subsidiaries (TI) reserve the right to make corrections, modifications, enhancements, improvements, and other changes to its products and services at any time and to discontinue any product or service without notice. Customers should obtain the latest relevant information before placing orders and should verify that such information is current and complete. All products are sold subject to TI's terms and conditions of sale supplied at the time of order acknowledgment.

TI warrants performance of its hardware products to the specifications applicable at the time of sale in accordance with TI's standard warranty. Testing and other quality control techniques are used to the extent TI deems necessary to support this warranty. Except where mandated by government requirements, testing of all parameters of each product is not necessarily performed.

TI assumes no liability for applications assistance or customer product design. Customers are responsible for their products and applications using TI components. To minimize the risks associated with customer products and applications, customers should provide adequate design and operating safeguards.

TI does not warrant or represent that any license, either express or implied, is granted under any TI patent right, copyright, mask work right, or other TI intellectual property right relating to any combination, machine, or process in which TI products or services are used. Information published by TI regarding third-party products or services does not constitute a license from TI to use such products or services or a warranty or endorsement thereof. Use of such information may require a license from a third party under the patents or other intellectual property of the third party, or a license from TI under the patents or other intellectual property of TI.

Reproduction of TI information in TI data books or data sheets is permissible only if reproduction is without alteration and is accompanied by all associated warranties, conditions, limitations, and notices. Reproduction of this information with alteration is an unfair and deceptive business practice. TI is not responsible or liable for such altered documentation. Information of third parties may be subject to additional restrictions.

Resale of TI products or services with statements different from or beyond the parameters stated by TI for that product or service voids all express and any implied warranties for the associated TI product or service and is an unfair and deceptive business practice. TI is not responsible or liable for any such statements.

TI products are not authorized for use in safety-critical applications (such as life support) where a failure of the TI product would reasonably be expected to cause severe personal injury or death, unless officers of the parties have executed an agreement specifically governing such use. Buyers represent that they have all necessary expertise in the safety and regulatory ramifications of their applications, and acknowledge and agree that they are solely responsible for all legal, regulatory and safety-related requirements concerning their products and any use of TI products in such safety-critical applications, notwithstanding any applications-related information or support that may be provided by TI. Further, Buyers must fully indemnify TI and its representatives against any damages arising out of the use of TI products in such safety-critical applications.

TI products are neither designed nor intended for use in military/aerospace applications or environments unless the TI products are specifically designated by TI as military-grade or "enhanced plastic." Only products designated by TI as military-grade meet military specifications. Buyers acknowledge and agree that any such use of TI products which TI has not designated as military-grade is solely at the Buyer's risk, and that they are solely responsible for compliance with all legal and regulatory requirements in connection with such use.

TI products are neither designed nor intended for use in automotive applications or environments unless the specific TI products are designated by TI as compliant with ISO/TS 16949 requirements. Buyers acknowledge and agree that, if they use any non-designated products in automotive applications, TI will not be responsible for any failure to meet such requirements.

Following are URLs where you can obtain information on other Texas Instruments products and application solutions:

Products		Applications	
Amplifiers	amplifier.ti.com	Audio	www.ti.com/audio
Data Converters	dataconverter.ti.com	Automotive	www.ti.com/automotive
DSP	dsp.ti.com	Broadband	www.ti.com/broadband
Interface	interface.ti.com	Digital Control	www.ti.com/digitalcontrol
Logic	logic.ti.com	Military	www.ti.com/military
Power Mgmt	power.ti.com	Optical Networking	www.ti.com/opticalnetwork
Microcontrollers	microcontroller.ti.com	Security	www.ti.com/security
RFID	www.ti-rfid.com	Telephony	www.ti.com/telephony
Low Power Wireless	www.ti.com/lpw	Video & Imaging	www.ti.com/video
		Wireless	www.ti.com/wireless

Mailing Address: Texas Instruments, Post Office Box 655303, Dallas, Texas 75265
Copyright © 2007, Texas Instruments Incorporated