



















- 1 
- 2 
- 3 
- 4 
- 5 
- 6 
- 7 
- 8 
- 9 
- 10 
- 11 
- 12 
- 13 
- 14 
- 15 
- 16 
- 17 
- 18 

**COVERING**

Injected polyurethane, hardness 55 Shore D.

**WHEEL CENTRE BODY**

Polyamide based (PA) technopolymer.

**ROLLING ACTION**

Hub with pass-through hole.

**TURNING PLATE BRACKET**

Electrolytically zinc-plated steel sheet bracket.

The presence of a double ball race and direct contact between the plate and the ball race ring with built-in pin ensure excellent manoeuvrability.

**FRONT-ACTUATED BRAKE**

Total brake that locks the wheel and bracket rotation. The optimised dimensions and the retractible pedal ensure minimal space occupied and maximum actuation ease.

**STANDARD EXECUTIONS**

- **SBL-G**: turning plate bracket, without brake.
- **SBF-G**: turning plate bracket, with brake.
- **CBL-G**: turning plate bracket and threaded centre pin, without brake.
- **CBF-G**: turning plate bracket and threaded centre pin, with brake.
- **FBL-G**: turning plate bracket and centre pass-through hole, without brake.
- **FBF-G**: turning plate bracket and centre pass-through hole, with brake.

**APPLICATIONS**

Castors for the general public with high carrying capacity, excellent rolling resistance and elasticity features, good wear and tearing resistance.

**ENVIRONMENTAL CONDITIONS**

RE.C6 twin castors are suitable for use in industrial and institutional environments, even in the presence of moisture and chemical agents. The good resistance to frequent cleaning cycles makes it suitable for environments where it is necessary to ensure hygiene.





Conversion Table	
1 mm = 0.039 inch	
D	
mm	inch
50	1.97

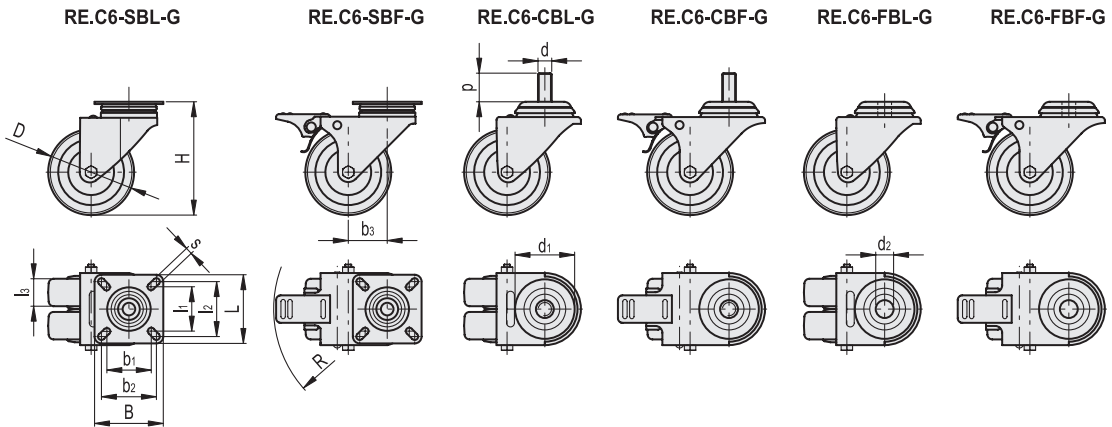

METRIC

Code	Description	D	d	p	d1	d2	l3	H	B	L	s	b1	l1	b2	l2	b3	R	Dynamic carrying capacity# [N]	⚖️
451929	RE.C6-050-SBL-G	50	-	-	-	-	18	71	60	60	6	39	39	49	49	25.5	-	1400	300
451939	RE.C6-050-SBF-G	50	-	-	-	-	18	71	60	60	6	39	39	49	49	25.5	83	1400	350
451959	RE.C6-050-CBL-G	50	M10	25	52	-	18	71	-	-	-	-	-	-	-	25.5	-	1400	310
451969	RE.C6-050-CBF-G	50	M10	25	52	-	18	71	-	-	-	-	-	-	-	25.5	83	1400	360
451979	RE.C6-050-FBL-G	50	-	-	55	10	18	71	-	-	-	-	-	-	-	25.5	-	1400	270
451989	RE.C6-050-FBF-G	50	-	-	55	10	18	71	-	-	-	-	-	-	-	25.5	83	1400	320

# For dynamic carrying capacity see Technical data (on page 1880).