

PROTECTION PRODUCTS

Description

RailClamp® TVS arrays are ultra low capacitance ESD protection devices designed to protect high speed data interfaces. This device offers desirable characteristics for board level protection including fast response time, low operating and clamping voltage, and no device degradation.

RClamp®0531Z has a typical capacitance of only 0.30pF. This allows it to be used on circuits operating in excess of 5GHz without signal attenuation.

RClamp0531Z is in a 2-pin SLP0603P2X3B package. It measures 0.6 x 0.3 mm with a nominal height of only 0.25mm. The leads are finished with lead-free NiAu. Each device will protect one line operating at 5 volts. It gives the designer the flexibility to protect single lines in applications where arrays are not practical. The combination of small size and high ESD surge capability makes them ideal for use in portable applications such as cellular phones, digital cameras, and RF modules.

Package Dimension

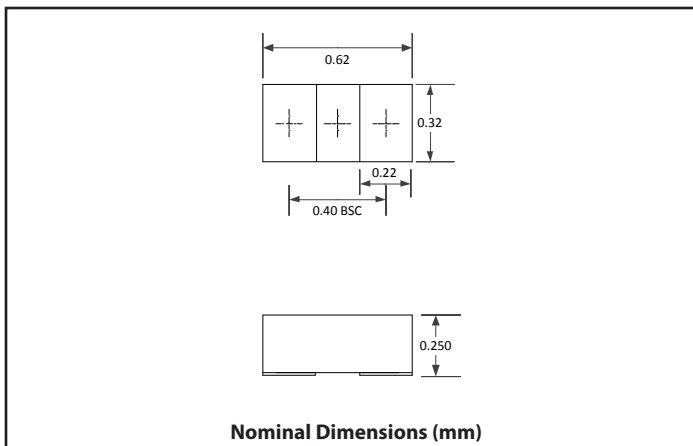

Features

- High ESD withstand Voltage: +/-12kV (Contact) and +/- 15kV (Air) per IEC 61000-4-2
- Able to withstand over 1000 ESD strikes per IEC61000-4-2 Level 4
- Ultra-small 0201 package
- Protects one high-speed data line
- Working voltage: +/- 5V
- Low capacitance: 0.30 pF typical
- Low leakage current: <5 nA typical ($V_R=5V$)
- Extremely low dynamic resistance: 0.67 Ω (Typ.)
- Solid-state silicon-avalanche technology

Mechanical Characteristics

- SLP0603P2X3B package
- Pb-Free, Halogen Free, RoHS/WEEE compliant
- Nominal Dimensions: 0.6 x 0.3 x 0.25 mm
- Lead Finish: NiAu
- Marking: Marking code + dot matrix date code
- Packaging: Tape and Reel

Applications

- RF Antenna and Modules
- FM Antenna
- USB 2.0
- MHL
- GPS

Schematic & Pin Configuration

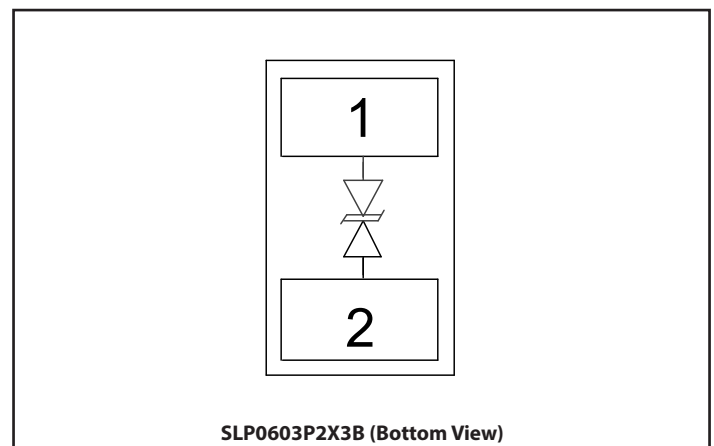

Absolute Maximum Rating

Rating	Symbol	Value	Units
Peak Pulse Power (tp = 8/20μs)	P _{PK}	60	W
Peak Pulse Current (tp = 8/20μs)	I _{PP}	3	A
ESD per IEC 61000-4-2 (Air) ESD per IEC 61000-4-2 (Contact)	V _{ESD}	±15 ±12	kV
Operating Temperature	T _J	-55 to +125	°C
Storage Temperature	T _{STG}	-55 to +150	°C

Electrical Characteristics (T=25°C unless otherwise specified)

Parameter	Symbol	Conditions	Min.	Typ.	Max.	Units
Reverse Stand-Off Voltage	V _{RWM}	Pin 1 to 2 or 2 to 1			5	V
Reverse Breakdown Voltage	V _{BR}	I _{BR} = 1 mA, Pin 1 to 2 or 2 to 1	7	9	11	V
Reverse Leakage Current	I _R	V _{RWM} = 5V, Pin 1 to 2 or 2 to 1		5	20	nA
Clamping Voltage	V _C	tp = 8/20μs	I _{PP} = 1A		15	V
			I _{PP} = 3A		20	
ESD Clamping Voltage ²	V _C	tp = 0.2/100ns	I _{PP} = 4A	13		V
			I _{PP} = 16A	21		
Dynamic Resistance ^{2,3}	R _{DYN}	tp = 0.2/100ns		0.67		Ω
Junction Capacitance	C _J	V _R = 0V to 5V, f = 1MHz		0.30	0.40	pF
Junction Capacitance ⁴	C _J	V _R = 0V to 5V, f = 1GHz			0.40	
Change in Capacitance Over V _R ⁴	ΔC _{JVR}	V _R = 0V to 5V, f = 1MHz			0.040	

Notes

- ESD gun return path connected to ESD ground plane.
- Transmission Line Pulse Test (TLP) Settings: tp = 100ns, tr = 0.2ns, I_{TLP} and V_{TLP} averaging window: t₁ = 70ns to t₂ = 90ns.
- Dynamic resistance calculated from I_{TLP} = 4A to I_{TLP} = 16A
- Guaranteed by design. Not production tested.

Typical Characteristics

Clamping Voltage vs. Peak Pulse Current

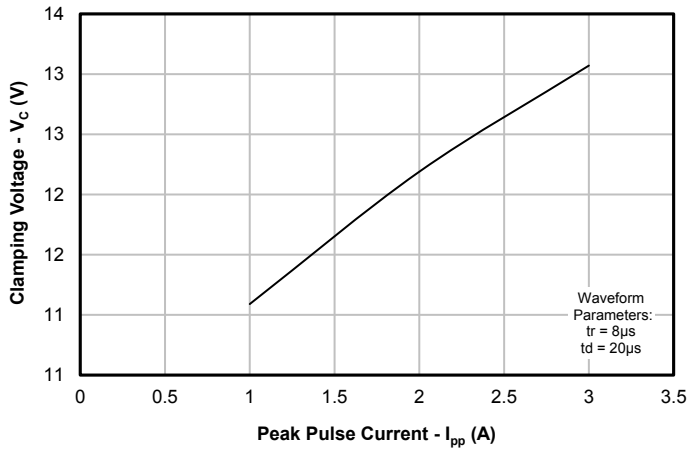

Junction Capacitance vs. Reverse Voltage

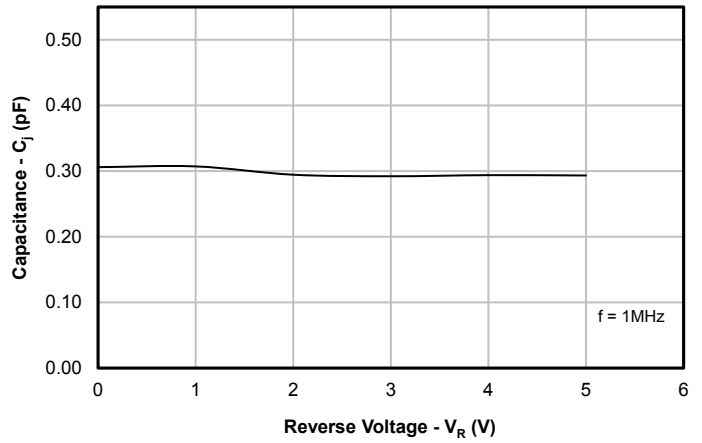

Typical Insertion Loss (S21)

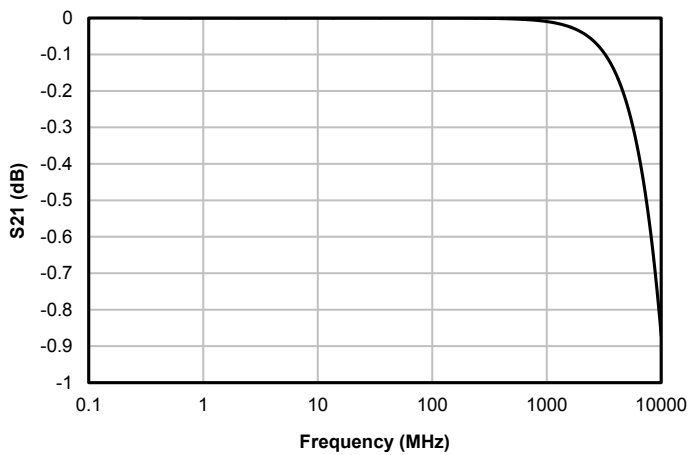

TLP Characteristic

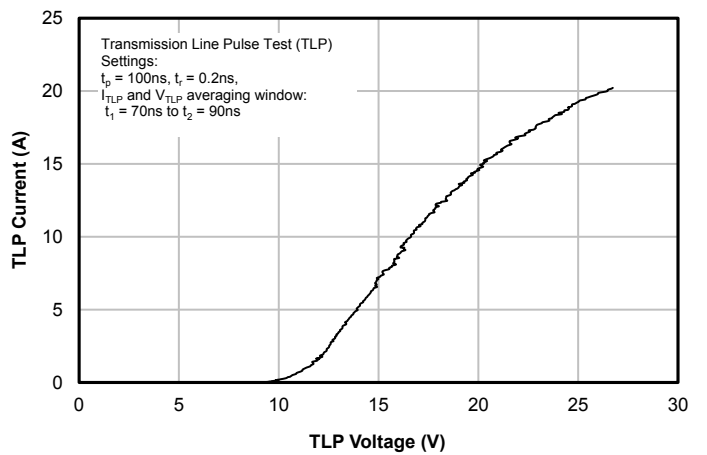

ESD Clamping (+8kV Contact per IEC 61000-4-2)

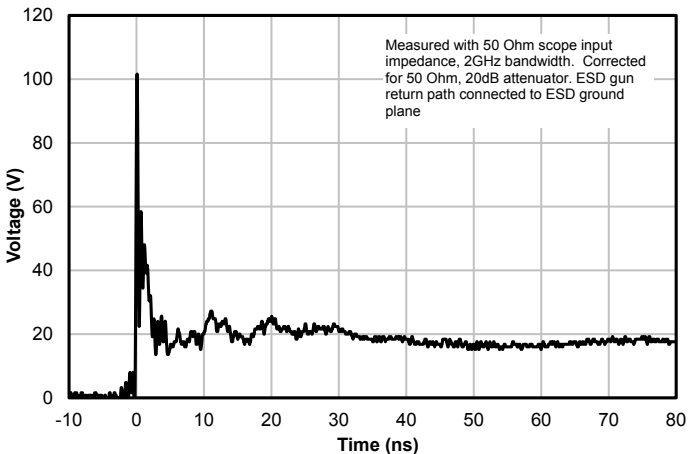

ESD Clamping (-8kV Contact per IEC 61000-4-2)

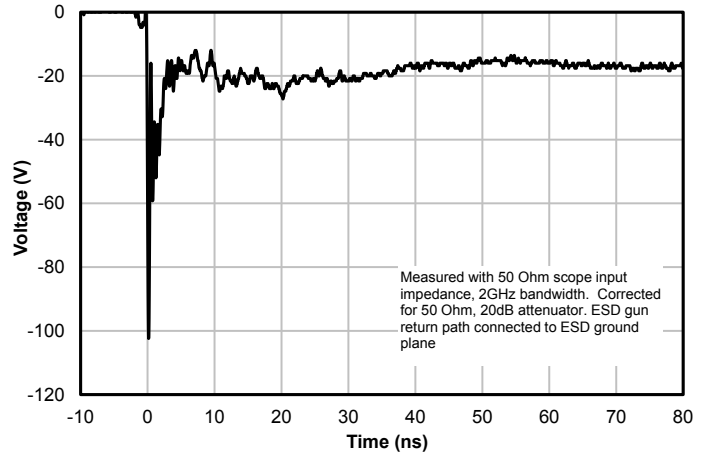

Application Information

Assembly Guidelines

The small size of this device means that some care must be taken during the mounting process to insure reliable solder joints. The figure at the right details Semtech's recommended mounting pattern. Recommended assembly guidelines are shown in Table 1. Note that these are only recommendations and should serve only as a starting point for design since there are many factors that affect the assembly process. Exact manufacturing parameters will require some experimentation to get the desired solder application.

Solder Stencil

Stencil design is one of the key factors which will determine the volume of solder paste which is deposited onto the land pad. The area ratio of the stencil aperture will determine how well the stencil will print. The area ratio takes into account the aperture shape, aperture size, and stencil thickness. A minimum area ratio of 0.66 is preferred for the subject package. The area ratio of a rectangular aperture is given as:

$$\text{Area Ratio} = (L * W) / (2 * (L + W) * T)$$

Where:

L = Aperture Length

W = Aperture Width

T = Stencil Thickness

Semtech recommends a stencil with square aperture and rounded corners for consistent solder release. The stencil should be laser cut with electropolished finish. A stencil thickness of 0.075mm (0.003") is recommended. A 0.100mm (0.004") stencil may be used, however the stencil opening may need to be increased slightly to achieve the desired area ratio to ensure proper solder coverage on the pad.

Recommended Mounting Pattern

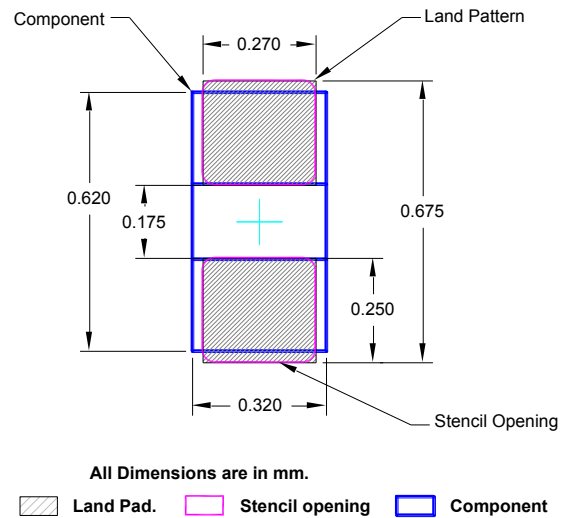

All Dimensions are in mm.

Land Pad. Stencil opening Component

Table 1 - Assembly Guidelines

Assembly Parameter	Recommendation
Solder Stencil Design	Laser Cut, Electro-Polished
Aperture Shape	Rectangular with Rounded Corners
Solder Stencil Thickness	0.075mm (0.003") or 0.100mm (0.004")
Solder Paste Type	Type 4 Size Sphere or Smaller
Solder Reflow Profile	Per JEDEC J-STD-020
PCB Solder Pad Design	Solder Mask Defined
PCB Pad Finish	OSP or NiAu

Outline Drawing - SLP0603P2X3B

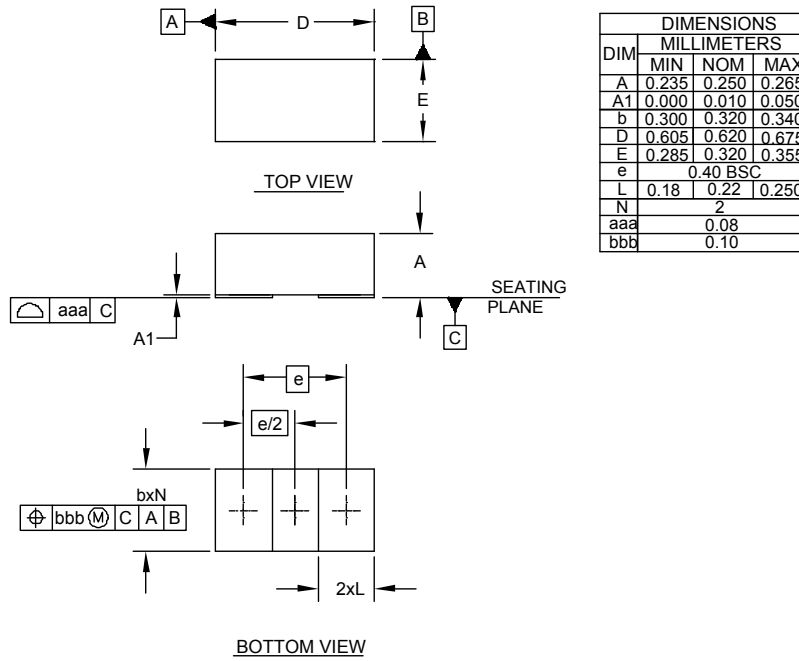

NOTES:

1. CONTROLLING DIMENSIONS ARE IN MILLIMETERS (ANGLES IN DEGREES).

Land Pattern - SLP0603P2X3B

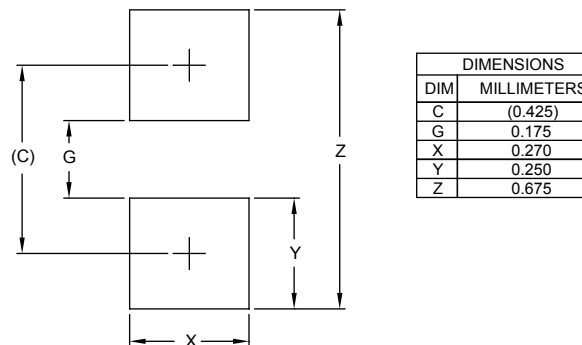

NOTES:

1. CONTROLLING DIMENSIONS ARE IN MILLIMETERS (ANGLES IN DEGREES).
2. THIS LAND PATTERN IS FOR REFERENCE PURPOSES ONLY.
CONSULT YOUR MANUFACTURING GROUP TO ENSURE YOUR COMPANY'S MANUFACTURING GUIDELINES ARE MET.

Marking Code

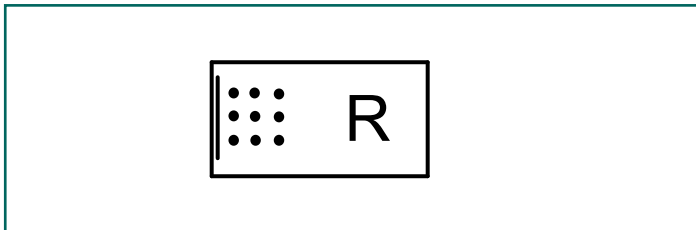

Notes:

- 1. Dots represent date code matrix and Pin 1 location.

Tape and Reel Specification

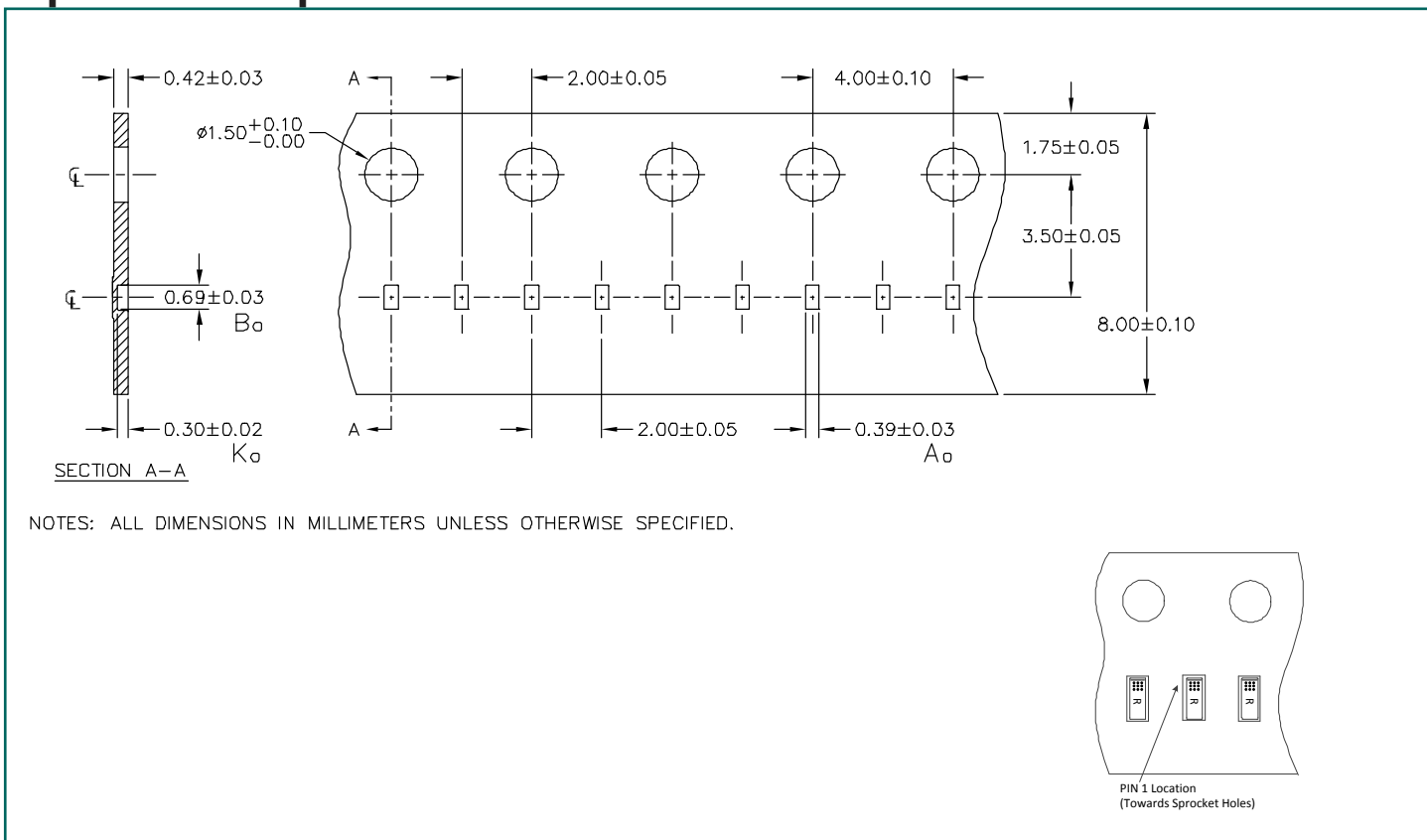

Tape and Reel Specification- Plastic Tape

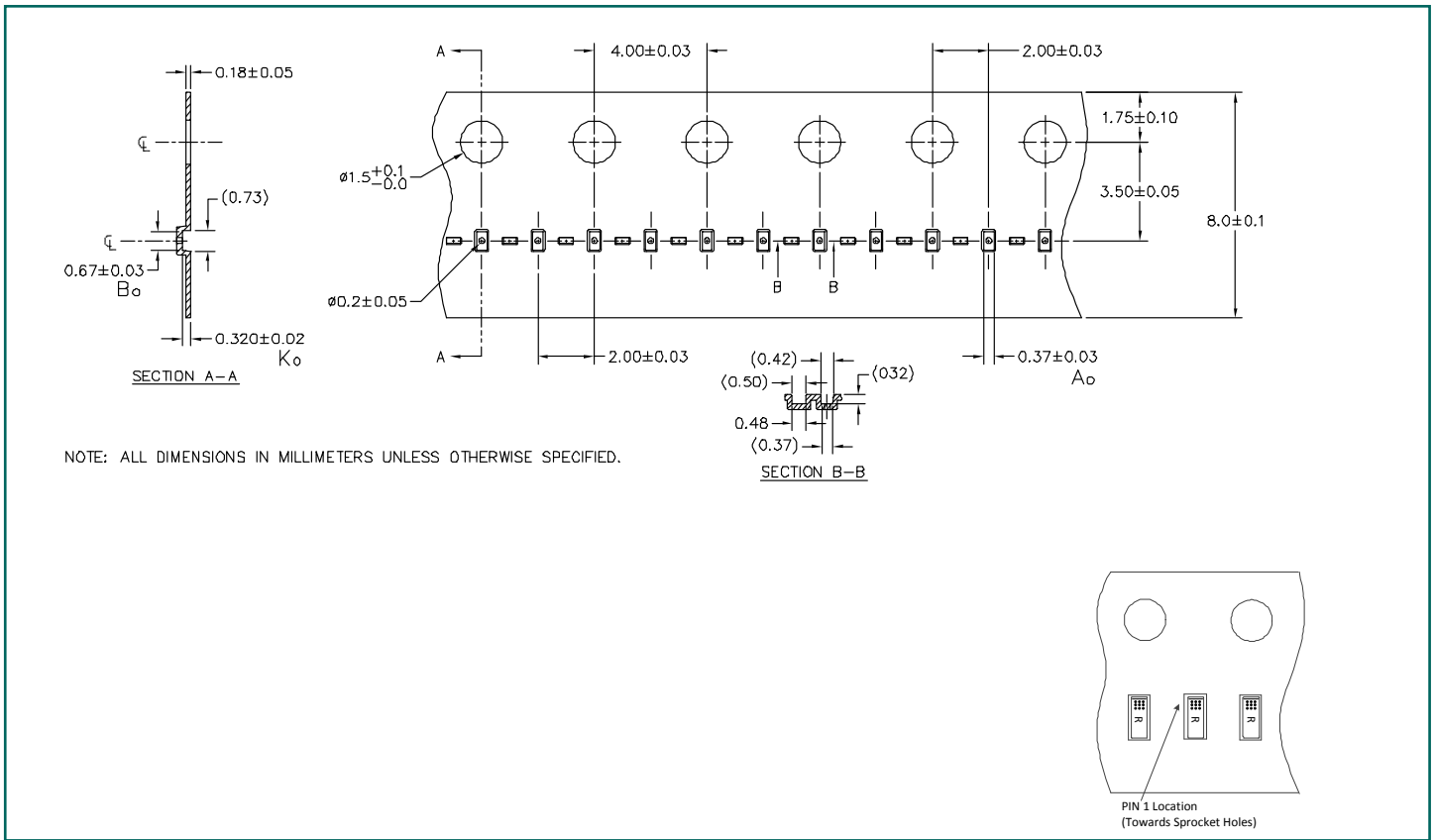

Ordering Information

Part Number	Qty per Reel	Carrier Tape	Reel Size	Comments
RClamp0531Z.TFT	15,000	Paper	7"	
RClamp0531Z.TNT	10,000	Plastic	7"	Not recommended for new designs



IMPORTANT NOTICE

Information relating to this product and the application or design described herein is believed to be reliable, however such information is provided as a guide only and Semtech assumes no liability for any errors in this document, or for the application or design described herein. Semtech reserves the right to make changes to the product or this document at any time without notice. Buyers should obtain the latest relevant information before placing orders and should verify that such information is current and complete. Semtech warrants performance of its products to the specifications applicable at the time of sale, and all sales are made in accordance with Semtech's standard terms and conditions of sale.

SEMTECH PRODUCTS ARE NOT DESIGNED, INTENDED, AUTHORIZED OR WARRANTED TO BE SUITABLE FOR USE IN LIFE-SUPPORT APPLICATIONS, DEVICES OR SYSTEMS, OR IN NUCLEAR APPLICATIONS IN WHICH THE FAILURE COULD BE REASONABLY EXPECTED TO RESULT IN PERSONAL INJURY, LOSS OF LIFE OR SEVERE PROPERTY OR ENVIRONMENTAL DAMAGE. INCLUSION OF SEMTECH PRODUCTS IN SUCH APPLICATIONS IS UNDERSTOOD TO BE UNDERTAKEN SOLELY AT THE CUSTOMER'S OWN RISK. Should a customer purchase or use Semtech products for any such unauthorized application, the customer shall indemnify and hold Semtech and its officers, employees, subsidiaries, affiliates, and distributors harmless against all claims, costs damages and attorney fees which could arise.

The Semtech name and logo are registered trademarks of the Semtech Corporation. All other trademarks and trade names mentioned may be marks and names of Semtech or their respective companies. Semtech reserves the right to make changes to, or discontinue any products described in this document without further notice. Semtech makes no warranty, representation or guarantee, express or implied, regarding the suitability of its products for any particular purpose. All rights reserved.

© Semtech 2015

Contact Information

Semtech Corporation
200 Flynn Road, Camarillo, CA 93012
Phone: (805) 498-2111, Fax: (805) 498-3804
www.semtech.com