

R/A FEMALE MODULE 4 SOLDER TYPE INSERTS

R694.252.106

2.5MM FOR PCB

Series : MCC2

4 Coax Position AB/1A ,1C

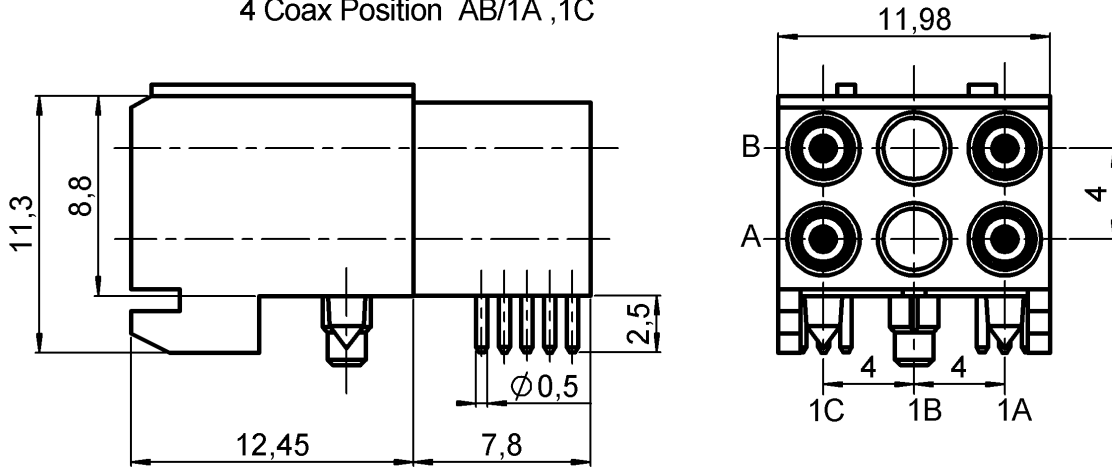

Connectors' packaging

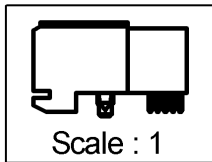
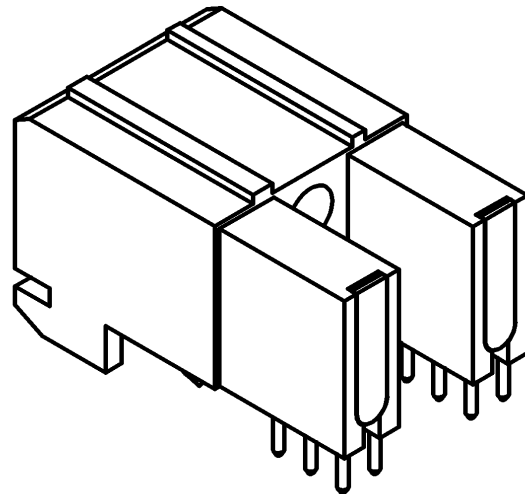
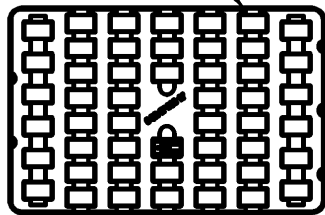

All dimensions are in mm.

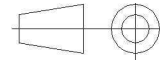

COMPONENTS	MATERIALS	PLATING (µm)
BODY	BRASS	NICKEL 2
CENTER CONTACT	BERYLLIUM COPPER	NPGR
OUTER CONTACT	BRASS	NPGR
INSULATOR	PEEK , ULTEM	
GASKET	-	
OTHERS PARTS	LIQUID CRISTAL POLYMER30%FV	
.	.	.
.	.	.

Issue : 0626 D

In the effort to improve our products, we reserve the right to make changes judged to be necessary.



R/A FEMALE MODULE 4 SOLDER TYPE INSERTS
2.5MM FOR PCB

R694.252.106

Series : MCC2

PACKAGING

SPECIFICATION

Standard	Unit	Other
50	'W' option	Contact us

ELECTRICAL CHARACTERISTICS

ENVIRONMENTAL

Impedance	50	Ω
Frequency	0-6	GHz
VSWR	1.15* + 0,0000	x F(GHz) Maxi
Insertion loss	0.2	\sqrt{F} (GHz) dB Maxi
RF leakage	- (AD)	- F(GHz)) dB Maxi
Voltage rating	500	Veff Maxi
Dielectric withstanding voltage	750	Veff mini
Insulation resistance	5000	M Ω mini

Operating temperature	-25/+125	$^{\circ}$ C
Hermetic seal	NA	Atm.cm3/s
Panel leakage	NA	

OTHER CHARACTERISTICS

Assembly instruction

Others :

*VSWR optimized between DC to 3GHz

MECHANICAL CHARACTERISTICS

Center contact retention		
Axial force – Mating end	6	N mini
Axial force – Opposite end	6	N mini
Torque	NA	N.cm mini
Recommended torque		
Mating	NA	N.cm
Panel nut	NA	N.cm
Mating life	500	Cycles mini
Weight	90,7030	g

Issue : 0626 D

In the effort to improve our products, we reserve the right to make changes judged to be necessary.



R/A FEMALE MODULE 4 SOLDER TYPE INSERTS

R694.252.106

2.5MM FOR PCB

Series : MCC2

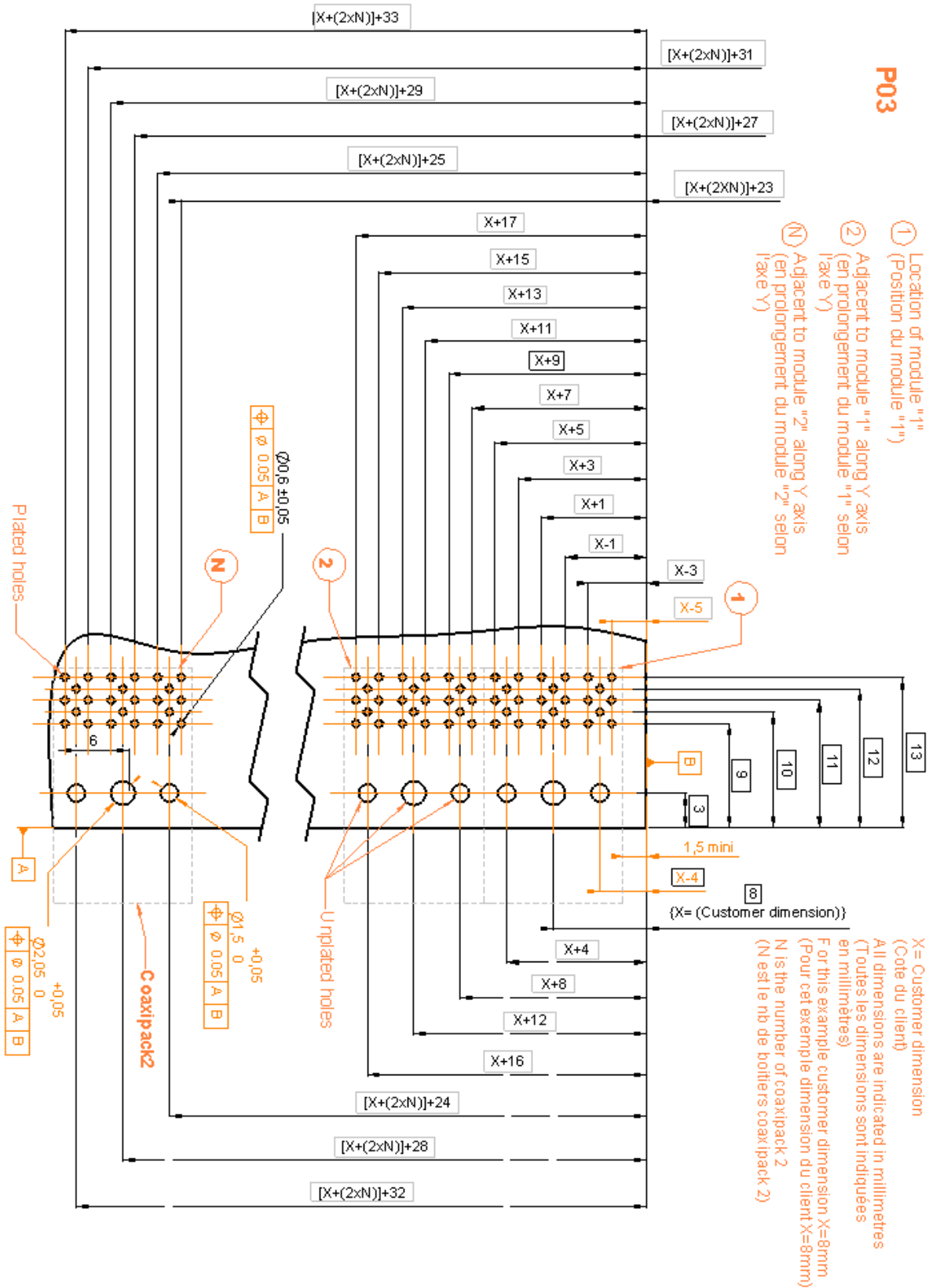

Issue : 0626 D

In the effort to improve our products, we reserve the right to make changes judged to be necessary.



R/A FEMALE MODULE 4 SOLDER TYPE INSERTS
2.5MM FOR PCB

R694.252.106

Series : MCC2

- Place the coax connector(s) on the PCB

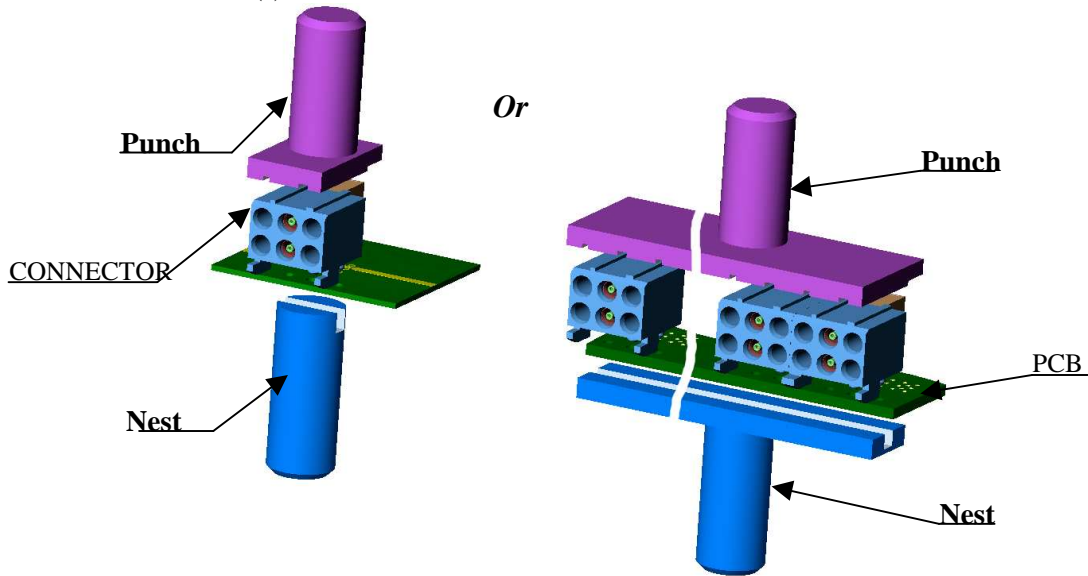

- Place correctly the PCB between the punch and the nest of the press.
- In case of multiple housing configuration , use a punch and a nest large enough to cover all the housings.
- Press on the plastic housing(s) with the punch until the complete insertion of the fixing stud into the PCB.

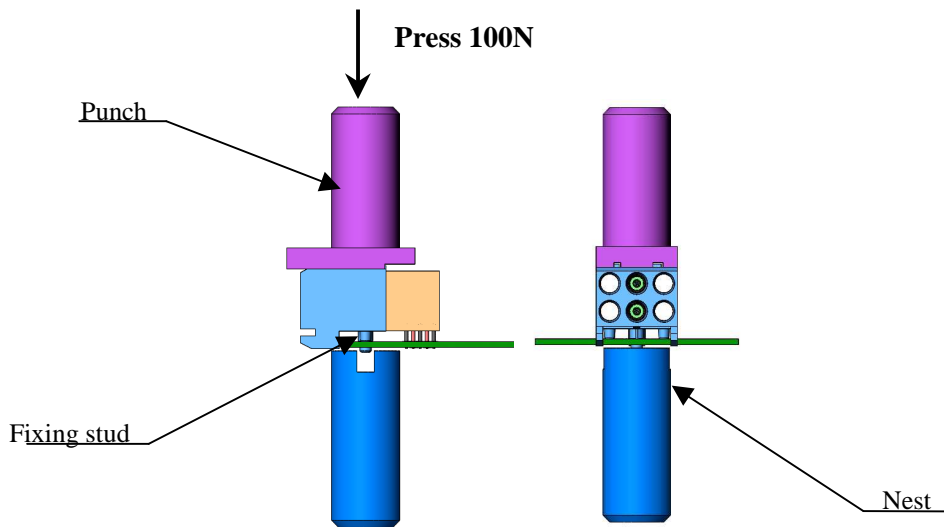

- Solder the legs on board

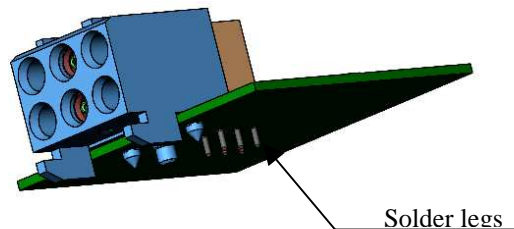

Radiall do not recommend to use more than 3 modules on the same motherboard and can't be held liable of any connection defect when more than 3 modules are implemented on the board.

Issue : 0626 D

In the effort to improve our products, we reserve the right to make changes judged to be necessary.

