

PAGE 1/2

ISSUE 22-03-22

SERIE : DPDT

PART NUMBER : R577422105

RF CHARACTERISTICS

Frequency range : **0 - 18 GHz**
 Impedance : **50 Ohms**

Frequency (GHz)	DC - 3	3 - 8	8 - 12.4	12.4 - 18
VSWR max	1.20	1.30	1.40	1.50
Insertion loss max	0.20 dB	0.30 dB	0.40 dB	0.50 dB
Isolation min	80 dB	70 dB	65 dB	60 dB
Average power (*)	240 W	150 W	120 W	100 W

ELECTRICAL CHARACTERISTICS

Actuator : **FAILSAFE**
 Nominal current ** : **340 mA**
 Actuator voltage (Vcc) : **12V (10.2 to 13V)**
 Terminals : **9 pins D-SUB male connector**
 Indicator rating : **1 W / 30 V / 100 mA**
 TTL inputs (E) - High level : **2.2 to 5.5 V / 800µA at 5.5 V**
 - Low level : **0 to 0.8 V / 20µA at 0.8 V**

MECHANICAL CHARACTERISTICS

Connectors : **SMA female per MIL-C 39012**
 Life : **2.5 million cycles**
 Switching Time*** : **< 15 ms**
 Construction : **Splashproof**
 Weight : **< 100 g**

ENVIRONMENTAL CHARACTERISTICS

Operating temperature range : **-40°C to +85°C**
 Storage temperature range : **-55°C to +85°C**

(* Average power at 25°C per RF Path)

(** At 25° C ±10%)

(*** Nominal voltage ; 25° C)



PAGE 2/2

ISSUE 22-03-22

SERIE : DPDT

PART NUMBER : R577422105

DRAWING

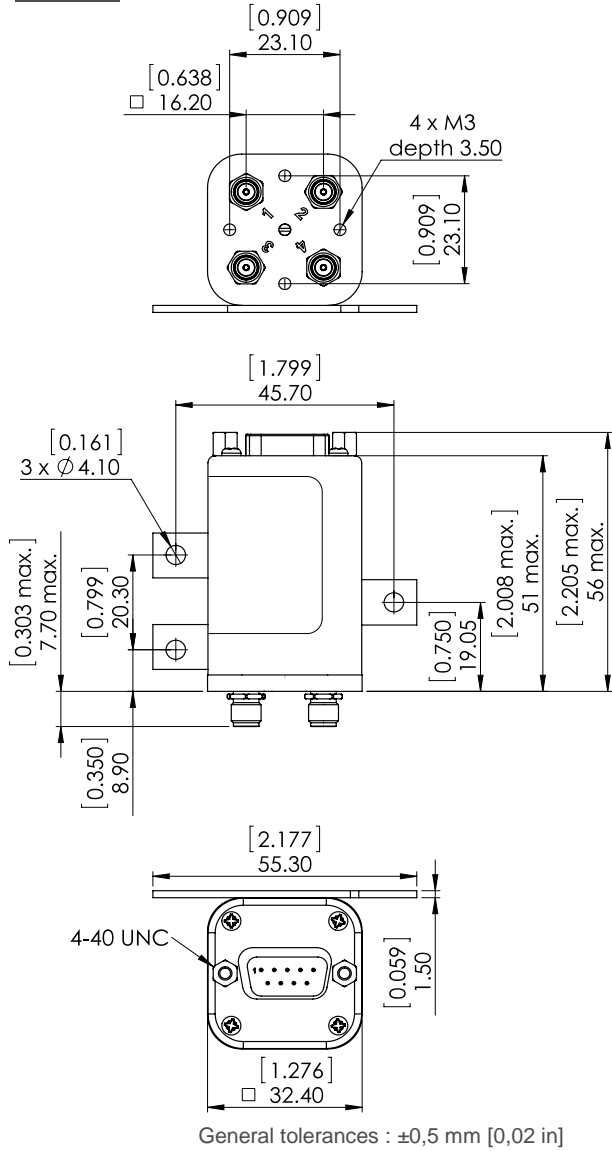

LABEL

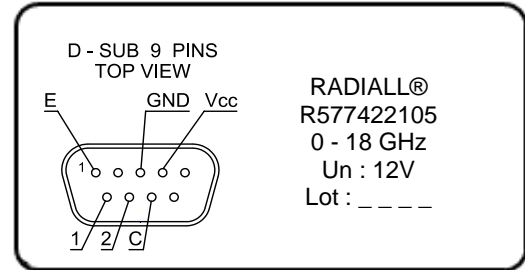

SCHEMATIC DIAGRAM

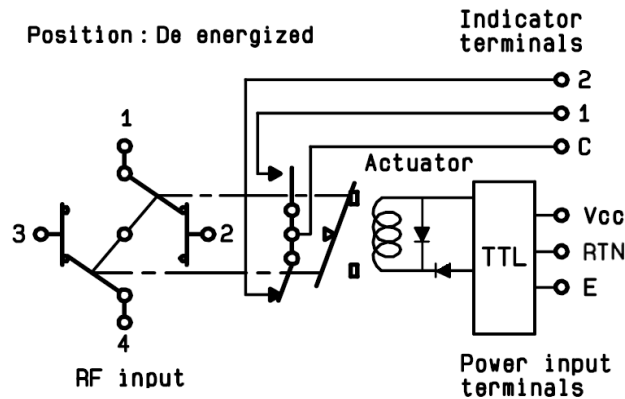

TTL input	RF Continuity	Ind.
E = 1	1 ↔ 3 / 2 ↔ 4	C.1
E = 0	1 ↔ 2 / 3 ↔ 4	C.2