

PAGE 1/2

ISSUE 22-03-22

SERIE : DPDT

PART NUMBER : R577022000

## RF CHARACTERISTICS

Frequency range : **0 - 3 GHz**  
 Impedance : **50 Ohms**

Frequency (GHz)	DC - 1	1 - 2	2 - 3
VSWR max	<b>1.15</b>	<b>1.20</b>	<b>1.25</b>
Insertion loss max	<b>0.15 dB</b>	<b>0.20 dB</b>	<b>0.25 dB</b>
Isolation min	<b>85 dB</b>	<b>80 dB</b>	<b>75 dB</b>
Average power (*)	<b>700 W</b>	<b>500 W</b>	<b>400 W</b>

## ELECTRICAL CHARACTERISTICS

Actuator : **FAILSAFE**  
 Nominal current \*\* : **340 mA**  
 Actuator voltage (Vcc) : **12V (10.2 to 13V)**  
 Terminals : **solder pins (250°C max. / 30 sec.)**  
 Indicator rating : **1 W / 30 V / 100 mA**

## MECHANICAL CHARACTERISTICS

Connectors : **N female per MIL-C 39012**  
 Life : **2.5 million cycles**  
 Switching Time\*\*\* : **< 15 ms**  
 Construction : **Splashproof**  
 Weight : **< 215 g**

## ENVIRONMENTAL CHARACTERISTICS

Operating temperature range : **-40°C to +85°C**  
 Storage temperature range : **-55°C to +85°C**

(\* Average power at 25°C per RF Path)

(\*\* At 25° C ±10%)

(\*\*\* Nominal voltage ; 25° C)



PAGE 2/2

ISSUE 22-03-22

SERIE : DPDT

PART NUMBER : **R577022000**

DRAWING

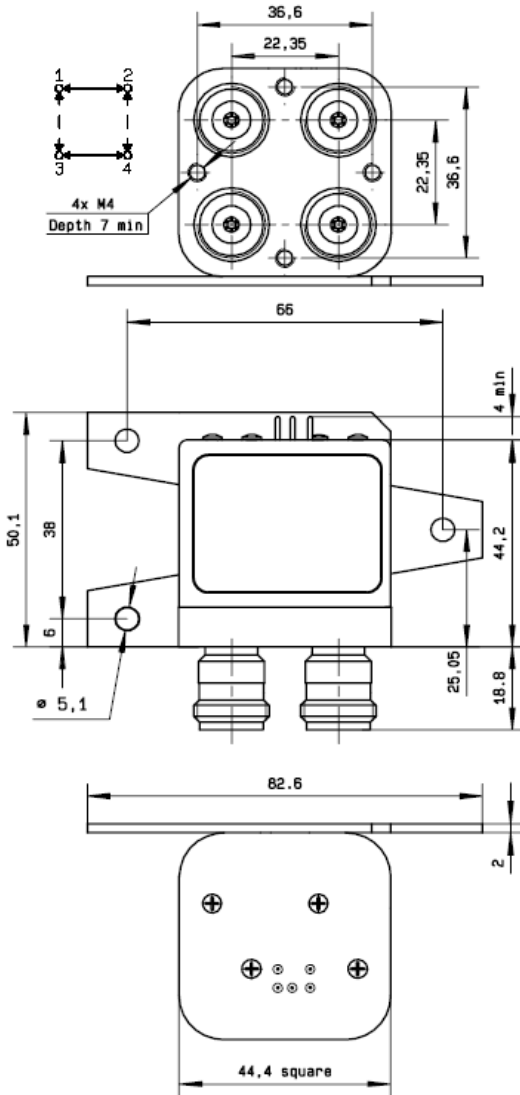

General tolerances : ±0,5 mm [0,02 in]

**LABEL**

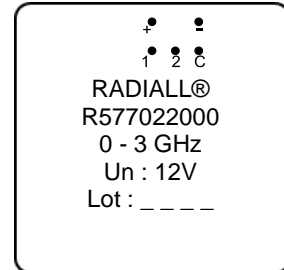

SCHEMATIC DIAGRAM

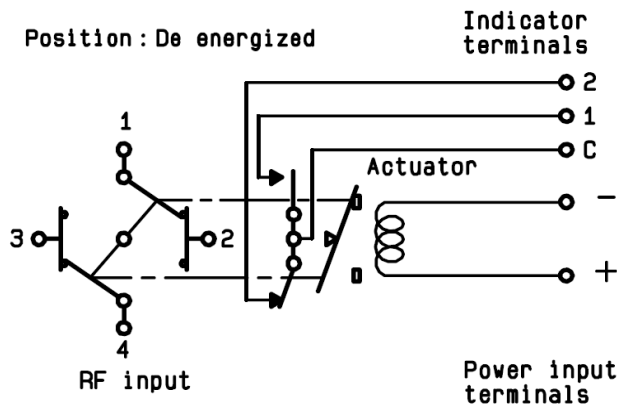

Voltage	RF Continuity	Ind.
energized	1 ↔ 3 / 2 ↔ 4	C.1
De-energized	1 ↔ 2 / 3 ↔ 4	C.2